

**BEFORE
THE CENTRAL ELECTRICITY REGULATORY COMMISSION
NEW DELHI**

PETITION NO.:

IN THE MATTER OF: Application under Section 14 & 15 of the Electricity Act, 2003 read with Central Electricity Regulatory Commission (Procedure, Terms and Conditions for Grant of Transmission License and other related matters) Regulations, 2024 with respect to Transmission License to Khavda PS1 and 3 Transmission Limited

Khavda PS1 and 3 Transmission Limited

(A 100% wholly owned subsidiary of Power Grid Corporation of India Limited)

Registered office: B-9, Qutab Institutional Area, Katwaria Sarai, New Delhi 110 016

Address for correspondence: C/o ED (TBCB), Power Grid Corporation of India Limited, Saudamini, Plot no.2, Sector -29, Gurgaon 122001

AND

Chief Operating Officer,
Central Transmission Utility of India Ltd,
Saudamini, Plot no.2, Sector -29,
Gurgaon 122001.....

RESPONDENT(S)

And Others

INDEX

Sl. No.	Description	Enclosures	Page No.
1	CERC Letter	-	(iii)
2	Form 1	-	(iv) - (v)
3	Memo of Appearance	-	(vi)
4	Dispatch proof	-	(vii)
5	Letter for registration	-	04
6	Memo of parties	-	05-07
7	Affidavit	-	08-09
8	Application	-	10-15
9	Extract of Gazette notification no. CG-DL-E-13052023-245856 dated 12.05.2023 has notified PFC Consulting Limited to be the Bid Process Coordinator (BPC)	Annexure-1	16
10	Extract of the RFP document as provided by BPC	Annexure-2	17
11	Copy of Letter of Intent (LoI)	Annexure-3	18-23

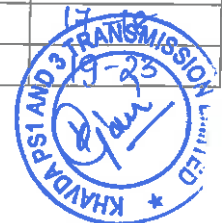

(i)

12	Copy of the relevant extract of Request for Proposal (RFP) along with letters from BPC	Annexure-4	24-26
13	Copy of Share purchase agreement (SPA)	Annexure-5	27-46
14	Copy of Transmission Service Agreement (TSA)	Annexure-6	47-208A(24)
15	Copy of SLD of the transmission scheme	Annexure-7	204
16	Form-1 for Transmission License with the following enclosures: a) Certificate of Registration, Memorandum of Association and Articles of Association: Enclosure-1 b) Certificate of Bid Evaluation Committee as furnished by BPC: Enclosure-2 c) Copy of Power of Attorney: Enclosure-3	Annexure-8	205-272

FILED BY
Khavda PS1 and 3 Transmission Limited

Place: New Delhi

Date: 12.11.2024



Khavda PS1 and 3 Transmission Limited

(A 100% wholly owned subsidiary Power Grid Corporation of India Limited)

B-9, Qutab Institutional Area, Katwaria Sarai, New Delhi - 110 016

CIN : U42201DL2023GOI424248

Ref: PG_KPS1&3TL/

Dated : 12.11.2024

To,
The Secretary,
Central Electricity Regulatory Commission,
7th Floor, Tower B, World Trade Centre,
Nauroji Nagar, New Delhi-110029.

Sub.: Application under Section 14 & 15 of the Electricity Act, 2003 read with Central Electricity Regulatory Commission (Procedure, Terms and Conditions for Grant of Transmission License and other related matters) Regulations, 2024 with respect to Transmission License to Khavda PS1 and 3 Transmission Limited

Sir,

Three copies (1 original + 2 copies) of the application for the above subject matter have been enclosed and e-filing has been done on CERC website. As per the public notice issued on 28.08.2010 by the Hon'ble Commission the amount of Rs. 1,00,000/- (Rupees One Lakhs only) for filing the application has been paid through RTGS and in accordance with the Regulations 12 (2), Payment of Fees Regulations 2012, Form-1 duly filled in against the aforementioned application is also enclosed herewith.

Electronic Copies of the application are being forwarded to the CTUIL (Nodal Agency), the Bid Process Coordinator, beneficiaries of the Western Region and DICs. The complete application along with Annexure is posted on the website: www.powergrid.in/subsidiaries.

Thanking You,

Yours faithfully,

(Ms. Khushboo Jain)
Finance Incharge

Khavda PS1 and 3 Transmission Limited
Mobile: +91- 9729021199 ; email : tbcs@powergrid.in

Enclosures: As above

Form-I

Particulars

1. Name of the Petitioner : **Khavda PS1 and 3 Transmission Limited**
(A 100% wholly owned subsidiary of
Power Grid Corporation of India Limited)
2. Address of the Petitioner/Applicant : **Khavda PS1 and 3 Transmission Limited**
(A 100% wholly owned subsidiary of
Power Grid Corporation of India Limited)
Regd. Address:
B-9, Qutab Institutional Area,
Katwaria Sarai, New Delhi-110 016
Address for correspondence:
Finance Incharge, Khavda PS1 and 3 Transmission
Limited, C/o ED (TBCB), Power Grid Corporation of
India Ltd, Saudamini, Plot no.2, Sector - 29, Gurgaon
122001
3. Subject Matter : Application under Section 14 & 15 of the Electricity
Act, 2003 read with Central Electricity Regulatory
Commission (Procedure, Terms and Conditions for
Grant of Transmission License and other related
matters) Regulations, 2024 with respect to
Transmission License to Khavda PS1 and 3
Transmission Limited
4. Petition No., if any : Not yet received
5. Details of generation assets : NOT APPLICABLE
(a) generating station/units
(b) Capacity in MW
(c) Date of commercial operation
(d) Period for which fee paid
(e) Amount of fee paid
(f) Surcharge, if any
6. Details of transmission assets : Assets under implementation by
Transmission line and sub-stations **Khavda PS1 and 3 Transmission Limited**
(b) Date of commercial operation
(c) Period for which fee paid
(d) Amount of fee paid
(g) Surcharge, if any
7. Fee paid for Adoption of tariff for : NOT APPLICABLE
(a) Generation asset
(b) Transmission asset



(iv)

8. Application fee for licence :
(a) Trading licence NO
(b) Transmission licence YES
(c) Period for which paid NOT APPLICABLE
(d) Amount of fee paid Rs.1,00,000/- only
9. Fees paid for Miscellaneous Application : NOT APPLICABLE
10. Fees paid for Interlocutory Application : NOT APPLICABLE
11. Fee paid for Regulatory Compliance : NOT APPLICABLE
petition
12. Fee paid for Review Application : NOT APPLICABLE
13. Licence fee for inter-State Trading : NOT APPLICABLE
(a) Category
(b) Period
(c) Amount of fee paid
(d) Surcharge, if any
14. Licence fee for inter-State Transmission : NOT APPLICABLE
(a) Expected/Actual transmission charge
(b) Period
(c) Amount of fee calculated as a percentage
of transmission charge.
(d) Surcharge, if any
15. Annual Registration Charge for Power : NOT APPLICABLE
Exchange
(a) Period
(b) Amount of turnover
(c) Fee paid
(d) Surcharge, if any
16. Details of fee remitted
- (a) UTR No. : CMS001570504124
(b) Date of remittance : 12.11.2024
(c) Amount remitted : Rs.1,00,000 (Rupees One Lakh only)

Signature of the authorized
signatory with date



(v)

BEFORE

THE CENTRAL ELECTRICITY REGULATORY COMMISSION

NEW DELHI

Petition No.: -----

IN THE MATTER OF: Application under Section 14 & 15 of the Electricity Act, 2003 read with Central Electricity Regulatory Commission (Procedure, Terms and Conditions for Grant of Transmission License and other related matters) Regulations, 2024 with respect to Transmission License to Khavda PS1 and 3 Transmission Limited

MEMO OF APPEARANCE

Khavda PS1 and 3 Transmission Limited --- PETITIONER

1. Pankaj Pandey, ED, POWERGRID
2. Shri Ms. Khushboo Jain, Finance Incharge, Khavda PS1 and 3 Transmission Limited
3. Ashwini Kumar Das, GM, POWERGRID

Filed by
Khavda PS1 and 3 Transmission Limited
Represented by

Place: New Delhi

Date: 12-11-2024

Ms. Khushboo Jain
Finance Incharge
(Khavda PS1 and 3 Transmission Limited)



(vi)

Rohit Jain {रोहित जैन}

From: tcbcb
Sent: 14 November 2024 12:06
To: tcbcb; cecomcseb@rediffmail.com; Manoj.K@cspc.co.in; eediv3@yahoo.co.in; decsp.guvnl@gebmail.com; aocom2.guvnl@gebmail.com; dksingh@mum.hwb.gov.in; dksingh1164@yahoo.com; wr1commercial; Manoj Kumar Tripathi {मनोज कुमार त्रिपाठी}; rajvarman.saxena@mppmcl.com; comml.deptt@mppmcl.com; gmppmsedcl@gmail.com; ceppmsedcl@gmail.com; acbpower@acbindia.com; lopamudra.kashyap@acbindia.com; satyanarayansoni@torrentpower.com; Niralishah@torrentpower.com; oa_commercial.seil@sembcorp.com; Prasanta Kumar Mahalik {पी.के. महालिक}; spotsales.india@sembcorp.com; electricitybill@barctara.gov.in; craman@barc.gov.in; Santu.Pal@gmrgroup.in; pramod.khandelwal@gmrgroup.in; dyceetrdwcr@gmail.com; cede@wr.railnet.gov.in; sales@dbpower.in; sanjay.jadhav@dbpower.in; ce.techcell@gmail.com; Manoj.K@cspc.co.in; acbpower@acbindia.com; lopamudra.kashyap@acbindia.com; hitesh.modi@acbindia.com; naresh.yadav@amns.in; cesecrly@gmail.com; dyceetrdcrly@gmail.com; bhavikshah@torrentpower.com; namanshah@torrentpower.com; rajesh.sirigirisetty@adani.com; Kashish Bhambhani {कशिश भम्भानी}; Swapnil Verma {स्वप्निल वर्मा}; Anil Kr Meena {अनिल कुमार मीना}; Project In-charge, ITP; Sanjay Nayak
Cc: Pankaj Pandey {पंकज पाण्डेय}; Ashwini Kr Das {अश्विनी कुमार दास}; Vikas Kumar {विकास कुमार}; Lingolu Aditya Mahesh {लिंगोलु आदित्य महेश}; Rohit Jain {रोहित जैन}; Kaushal Kishor {कौशल किशोर}
Subject: Khavda PS1 and 3 Transmission Limited : Application under Section 14 & 15 of the Electricity Act, 2003 for Grant of Transmission License
Attachments: GoTL_DRCKPS1&3_Email.PDF

Dear Sir/Mam,

The following application is being filed before CERC:

Application under Section 14 & 15 of the Electricity Act, 2003 read with Central Electricity Regulatory Commission (Procedure, Terms and Conditions for Grant of Transmission License and other related matters) Regulations, 2024 with respect to Transmission License to Khavda PS1 and 3 Transmission Limited

The soft copy of this application is attached with this mail for your kind information and necessary action please.

Please note that the hard copy of the same is already dispatched to you.



With Regards,

Khavda PS1 and 3 Transmission Limited

(Vij)

**BEFORE THE CENTRAL ELECTRICITY REGULATORY COMMISSION
NEW DELHI**

**Application under Section 14 & 15 of the Electricity Act, 2003 read with
Central Electricity Regulatory Commission (Procedure, Terms and
Conditions for Grant of Transmission License and other related matters)
Regulations, 2024 with respect to Transmission License to Khavda PS1 and
3 Transmission Limited**

APPLICATION NO :.....

Khavda PS1 and 3 Transmission Limited
(A 100% wholly owned subsidiary of Power Grid Corporation of India Limited)

Registered office:

B-9, Qutab Institutional Area, Katwaria Sarai, New Delhi - 110 016

Address for Correspondence:

C/o ED (TBCB), Power Grid Corporation of India Limited
Saudamini, Plot no.2, Sector -29, Gurgaon 122001



**BEFORE THE HON'BLE CENTRAL ELECTRICITY REGULATORY COMMISSION
NEW DELHI**

APPLICATION No :.....

IN THE MATTER OF

Application under Section 14 & 15 of the Electricity Act, 2003 read with Central Electricity Regulatory Commission (Procedure, Terms and Conditions for Grant of Transmission License and other related matters) Regulations, 2024 with respect to Transmission License to Khavda PS1 and 3 Transmission Limited

Khavda PS1 and 3 Transmission Limited

(A 100% wholly owned subsidiary of Power Grid Corporation of India Limited)

Registered office: B-9, Qutab Institutional Area, Katwaria Sarai, New Delhi 110 016

Address for correspondence: C/o ED (TBCB), Power Grid Corporation of India Limited, Saudamini, Plot no.2, Sector -29, Gurgaon 122001

AND

Chief Operating Officer,
Central Transmission Utility of India Ltd,
Saudamini, Plot no.2, Sector -29,
Gurgaon 122001.....

RESPONDENT(S)

And Others

INDEX

Sl. No	Description	Annexure No.	Page No.
1.	Letter for registration	-	04
2.	Memo of parties	-	05-07
3.	Affidavit	-	08-09
4.	Application	-	10-15
5.	Extract of Gazette notification no. CG-DL-E-13052023-245856 dated 12.05.2023 has notified PFC Consulting Limited to be the Bid Process Coordinator (BPC)	Annexure-1	16
6.	Extract of the RFP document as provided by BPC	Annexure-2	17-18
7.	Copy of Letter of Intent (LoI)	Annexure-3	19-23
8.	Copy of the relevant extract of Request for Proposal (RFP) along with letters from BPC	Annexure-4	24-26
9.	Copy of Share purchase agreement (SPA)	Annexure-5	27-46
10.	Copy of Transmission Service Agreement (TSA)	Annexure-6	47-203 (24)
11.	Copy of SLD of the transmission scheme	Annexure-7	

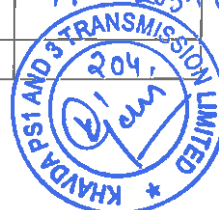

12.	Form-1 for Transmission License with the following enclosures : a) Certificate of Registration, Memorandum of Association and Articles of Association: Enclosure-1 b) Certificate of Bid Evaluation Committee as furnished by BPC: Enclosure-2 c) Copy of Power of Attorney: Enclosure-3	Annexure-8	205-272
-----	---	------------	---------

Filed by
Khavda PS1 and 3 Transmission Limited
(A 100% wholly owned subsidiary of Power Grid Corporation of India Limited)

Represented by Ms. Khushboo Jain
Finance Incharge, Khavda PS1 and 3 Transmission Limited

Place: New Delhi

Date : 07.11.2024



**BEFORE THE CENTRAL ELECTRICITY REGULATORY COMMISSION
NEW DELHI**

APPLICATION No :.....

IN THE MATTER OF

Application under Section 14 & 15 of the Electricity Act, 2003 read with Central Electricity Regulatory Commission (Procedure, Terms and Conditions for grant of Transmission License and other related matters) Regulations, 2024 with respect to Transmission License to **Khavda PS1 and 3 Transmission Limited**

Khavda PS1 and 3 Transmission Limited

(A 100% wholly owned subsidiary of Power Grid Corporation of India Limited)

Registered office: B-9, Qutab Institutional Area, Katwaria Sarai, New Delhi 110 016

Address for correspondence: C/o ED (TBCB), Power Grid Corporation of India Limited, Saudamini, Plot no.2, Sector -29, Gurgaon 122001

AND

Chief Operating Officer,
Central Transmission Utility of India Ltd,
Saudamini, Plot no.2, Sector -29,
Gurgaon 122001.....

RESPONDENT(S)

And Others

To
The Secretary
Central Electricity Regulatory Commission
New Delhi

Sir,

The application filed under Section 14 & 15 of the Electricity Act, 2003 read with Central Electricity Regulatory Commission (Procedure, Terms and Conditions for Grant of Transmission License and other related matters) Regulations, 2024 with respect to Transmission License to Khavda PS1 and 3 Transmission Limited, may please be registered.

Applicant

Khavda PS1 and 3 Transmission Limited

(A 100% wholly owned subsidiary of Power Grid Corporation of India Limited)

Represented by **Ms. Khushboo Jain**
Finance Incharge, Khavda PS1 and 3 Transmission Limited

Place: New Delhi

Date: 07.11.2024



**BEFORE THE CENTRAL ELECTRICITY REGULATORY COMMISSION
NEW DELHI**

APPLICATION No :.....

IN THE MATTER OF

Application under Section 14 & 15 of the Electricity Act, 2003 read with Central Electricity Regulatory Commission (Procedure, Terms and Conditions for Grant of Transmission License and other related matters) Regulations, 2024 with respect to Transmission License to Khavda PS1 and 3 Transmission Limited

Khavda PS1 and 3 Transmission Limited

(A 100% wholly owned subsidiary of Power Grid Corporation of India Limited)

Registered office: B-9, Qutab Institutional Area, Katwaria Sarai, New Delhi 110 016

Address for correspondence: C/o ED (TBCB), Power Grid Corporation of India Limited, Saudamini, Plot no.2, Sector -29, Gurgaon 122001

AND

Chief Operating Officer,
Central Transmission Utility of India Ltd,
Saudamini, Plot no.2, Sector -29,
Gurgaon 122001.....

RESPONDENT(S)

And Others

To
The Secretary
Central Electricity Regulatory Commission
New Delhi

MEMO OF PARTIES

Khavda PS1 and 3 Transmission Limited

(A 100% wholly owned subsidiary of Power Grid Corporation of India Limited)

Registered office: B-9, Qutab Institutional Area, Katwaria Sarai, New Delhi 110 016

Address for correspondence: C/o ED (TBCB), Power Grid Corporation of India Limited, Saudamini, Plot no.2, Sector -29, Gurgaon 122001

VERSUS

1.	Chief Operating Officer, Central Transmission Utility of India Ltd, Saudamini, Plot no.2, Sector -29, Gurgaon 122001Respondent
2.	PFC Consulting LimitedRespondent



	9thFloor, Wing-A, Statesman House, Connaught Place, New Delhi - 110001	
3.	Chhatisgarh State Power Distribution Co. Ltd. CSPDCL, Post: Sundernagar,Dangania, Raipur- 492013Respondent
4.	Goa Electricity Deparement-WR Goa Electricity DeptCurti, Ponda403401Respondent
5.	Gujarat Urja Vikas Nigam Limited Sardar Patel Vidyut Bhavan, Racecourse Vadodara - 390007Respondent
6.	Heavy Water Board O FLOOR, VIKRAM SARABHAI BHAVAN, TROMBAY, ANUSHAKTINAGAR, MUMBAI - 400094 , MaharashtraRespondent
7.	HVDC Bhadrawati, PGCIL PGCIL RHQ, WR-I, Sampriiti Nagar, , Off National Highway No. 8, Taluka : Kamrej,PO: Uppalwadi , Nagpur , 440026 MaharashtraRespondent
8.	HVDC Vindhyachal, PGCIL PGCIL RHQ, WR-I, Sampriiti Nagar, , Off National Highway No. 8, Taluka : Kamrej,PO: Uppalwadi , Nagpur , 440026 MaharashtraRespondent
9.	M.P. Power Management Company Ltd. 14, Shakti Bhawan, Rampur, Jabalpur - 482008Respondent
10.	MSEDCL Plot No 9, "prakashgad", A K Marg, Bandra East, Mumbai 400051Respondent
11.	ACB India LIMITED 7th Floor, Corporate Tower, Ambience Mall, NH-8, Gurgaon-122 001(Haryana)Respondent
12.	Torrent Power Limited Torrent Power Ltd. Naranpura Zonal Office, Sola Road, Ahmedabad, 380013Respondent
13.	Thermal Powertech Corporation India 6-3-1090, Clock C, Level 2, TSR , Towers, Rajbhavan Road, Somajiguda , Hyderabad , 500082, TelanganaRespondent



14.	BARC Bhabha Atomic Research Centre, Anushakti Nagar, Mumbai, Maharashtra – 400085Respondent
15.	GMR Warora Energy Limited Plot B-1,GMR Warora Energy Ltd, Mohabala MIDC Growth Centre, Post – Warora, Dist – Chandrapur, Maharashtra, PIN 442907Respondent
16.	HVDC Champa PGCIL RHQ, WR-I, Sampriti Nagar, , Off National Highway No. 8, Taluka : Kamrej,PO: Uppalwadi , Nagpur , 440026 MaharashtraRespondent
17.	West Central Railway Head Office General Manager's Office,Electrical Branch, Jabalpur– 482 001.Respondent
18.	Western Railway Office Of Chief Electrical EngineerMumbaiRespondent
19.	DB Power Limited- Untied Opp Dena Bank, C-31, G- BlockMumbaiRespondent
20.	Chhattisgarh State Power Trading Co. Ltd. 2nd floor Vidyut Sewa BhawanRaipurRespondent
21.	TRN Energy Private Ltd-Untied 7th Floor, Ambience Office BlockGurugramRespondent
22.	Adani Power (Mundra) Limited. Adani Corporate House, Shantigram, Near Vaishnavdevi Circle, S G Road Ahmedabad - 382421Respondent
23.	Raigarh HVDC Station RPT HVDC Office, Hebbal, Bangalore – 560094Respondent
24.	Arcelor Mittal Nippon Steel India Ltd. 27,AMNS House, 2TH KM Surat Hazira road, Hazira-394270, GujaratRespondent
25.	Central Railway Pcee's office 2nd floor parcle building csmt mumbai-400001Respondent



26.	Dadra and Nagar Haveli and Daman an Power Distribution Corporation Ltd 1st & 2nd Floor, Vidyut Bhavan, NexSilvassa & DamanRespondent
27.	MPSEZ Utilities Ltd. 3rd Floor, Adani Corporate House, SAhmedabadRespondent



**BEFORE THE HON'BLE CENTRAL ELECTRICITY REGULATORY
COMMISSION
NEW DELHI**

APPLICATION No :.....

IN THE MATTER OF

Application under Section 14 & 15 of the Electricity Act, 2003 read with Central Electricity Regulatory Commission (Procedure, Terms and Conditions for Grant of Transmission License and other related matters) Regulations, 2024 with respect to Transmission License to Khavda PS1 and 3 Transmission Limited

Khavda PS1 and 3 Transmission Limited

(A 100% wholly owned subsidiary of Power Grid Corporation of India Limited)

Registered office: B-9, Qutab Institutional Area, Katwaria Sarai, New Delhi 110 016

Address for correspondence: C/o ED (TBCB), Power Grid Corporation of India Limited, Saudamini, Plot no.2, Sector -29, Gurgaon 122001

AND

Chief Operating Officer,
Central Transmission Utility of India Ltd,
Saudamini, Plot no.2, Sector -29,
Gurgaon 122001.....

RESPONDENT(S)

And Others

AFFIDAVIT



I, Ms. Khushboo Jain, daughter of daughter of Shri. Pradeep Kumar Jain residing at Block C-7, Flat No. 403, PWO Apartments, Sector 43, Gurgaon -122001 do hereby solemnly affirm and state as follows:

1. That the deponent is the Authorised Signatory of Applicant, and is well conversant with the facts and the circumstances of the case and therefore competent to swear this affidavit.



(Handwritten signature)

2. That the accompanying Petition under Section 14 & 15 of the Electricity Act, 2003, has been filed by me and the contents of the same are true and correct to the best of my knowledge and belief.
3. That the contents of Para 1 to 24 of the facts as mentioned in the Petition are true and correct based on my personal knowledge, belief and records maintained in the office.
4. That the annexures annexed to the Petition are correct and true copies of the respective originals.
5. That the Deponent has not filed any other Petition or Appeal before any other forum or court of law with respect to the subject matter of the dispute.

KJ

[Signature]

.....
Authorised Signatory
Khavda PS1 and 3 Transmission Limited
(A 100% wholly owned subsidiary of Power Grid Corporation of India Limited)

Place: New Delhi
Date: 07.11.2024

VERIFICATION:

I, the Deponent above named hereby solemnly hereby affirm that the contents of the above affidavit are true to my knowledge, no part of it is false and nothing material has been concealed therefrom. Verified by me on this the 07th day of November, 2024 at New Delhi.

[Signature]

Deponent

Witness



ATTESTED
[Signature]
NOTARY PUBLIC
NEW DELHI. (INDIA)

07 NOV 2024

**BEFORE THE CENTRAL ELECTRICITY REGULATORY COMMISSION
NEW DELHI**

Application No.....

IN THE MATTER OF

Application under Section 14 & 15 of the Electricity Act, 2003 read with Central Electricity Regulatory Commission (Procedure, Terms and Conditions for Grant of Transmission License and other related matters) Regulations, 2024 with respect to Transmission License to Khavda PS1 and 3 Transmission Limited

Khavda PS1 and 3 Transmission Limited

(A 100% wholly owned subsidiary of Power Grid Corporation of India Limited)

Registered office: B-9, Qutab Institutional Area, Katwaria Sarai, New Delhi 110 016

Address for correspondence: C/o ED (TBCB), Power Grid Corporation of India Limited, Saudamini, Plot no.2, Sector -29, Gurgaon 122001

AND

Chief Operating Officer,
Central Transmission Utility of India Ltd,
Saudamini, Plot no.2, Sector -29,
Gurgaon 122001

RESPONDENT(S)

And Others

Application

The Applicant respectfully submits as under:

1. **Khavda PS1 and 3 Transmission Limited** hereby submits this application under Section 14 & 15 of the Electricity Act, 2003, Central Electricity Regulatory Commission (Procedure, Terms and Conditions for Grant of Transmission License and other related matters) Regulations, 2024 (hereinafter referred to as "Transmission License Regulations") to establish Inter-state transmission system for "**Provision of Dynamic Reactive Compensation at Khavda Pooling Station 1 (KPS1) and Khavda Pooling Station 3 (KPS3)**" on build, own, operate and transfer basis (hereinafter referred to as "the Project") consisting of the following elements:



10

Sl. No.	Name of the Transmission Element	Schedule d COD in months from Effective Date	Percentage of Quoted Transmission Charges recoverable on Scheduled COD of the Element of the Project	Element(s) which are pre-required for declaring the commercial operation (COD) of the respective Element
1.	<p>± 300 MVAR STATCOM with 1x125 MVAR MSC, 2x125 MVAR MSR at KPS1, 400 kV Bus section-1 with 1 No. of 400 kV bay (GIS)</p> <ul style="list-style-type: none"> • ± 300 MVAR STATCOM with 1x125 MVAR MSC, 2x125 MVAR MSR • 400 kV bay (GIS) – 1 No. (KPS1 Bus Section-1) 	24 months from SPV acquisition	33.334%	-
5.	<p>± 300 MVAR STATCOM with 1x125 MVAR MSC, 2x125 MVAR MSR at KPS1, 400 kV Bus section-2 with 1 No. of 400 kV bay (GIS)</p> <ul style="list-style-type: none"> • ± 300 MVAR STATCOM with 1x125 MVAR MSC, 2x125 MVAR MSR • 400 kV bay (GIS) – 1 No.(KPS1 Bus Section-2) 		33.333%	-
6.	<p>± 300 MVAR STATCOM with 1x125 MVAR MSC, 2x125 MVAR MSR at KPS3 400 kV Bus section-1 with 1 No. of 400 kV bay (GIS)</p> <ul style="list-style-type: none"> • ± 300 MVAR STATCOM with 1x125 MVAR MSC, 2x125 MVAR MSR • 400kV bay (GIS) – 1 No. (KPS3 Bus Section-1) 		33.333%	-

Note:

- i) TSPs of KPS1 and KPS3 shall provide space for one (1) 400 kV bay (each) for termination of STATCOM.
- ii) Land for installation of STATCOM (with MSC/MSR) as specified above shall be arranged by TSP implementing the STATCOM.
- iii) Bay(s) required for completion of diameter (GIS) in one-and-half breaker scheme, shall also be executed by the TSP under the present scope



2. Ministry of Power, Government of India, vide Gazette notification no. CG-DL-E-13052023-245856 dated 12.05.2023 has notified PFC Consulting Limited (PFCCL) as the Bid Process Coordinator (hereinafter referred to as BPC) for the purpose of selection of Bidder as Transmission Service Provider (TSP) to establish Inter-State transmission system for "Provision of Dynamic Reactive Compensation at Khavda Pooling Station 1 (KPS1) and Khavda Pooling Station 3 (KPS3) "(hereinafter referred to as "the Project") through Tariff Based Competitive Bidding process on build, own, operate and transfer basis. A copy of the notification is enclosed and marked as **Annexure-1**, (Page ...16... to Page ...16..).
3. That a company under the Companies Act 2013 by the name "**Khavda PS1 and 3 Transmission Limited**" having its registered office at New Delhi has been incorporated on 22.12.2023 by PFCCL as its wholly owned subsidiary to initiate the activities for execution of the Project and subsequently to act as Transmission Service Provider (TSP) after being acquired by the successful bidder selected through Tariff Based Competitive Bidding process.
4. BPC has initiated the selection of successful bidder to acquire the TSP in accordance with the "Tariff Based Competitive Bidding Guidelines for Transmission Service" and "Guidelines for Encouraging Competition in Development of Transmission Projects" issued by Government of India, Ministry of Power under section – 63 of The Electricity Act, 2003 and as amended from time to time.
5. That in the RFP documents, the following is stated
Quote
"The Transmission Charges shall be payable by the Designated ISTS Customers in Indian Rupees through the CTU as per Central Electricity Regulatory Commission (Sharing of Inter-State Transmission Charges and Losses) Regulations as amended from time to time.."
Unquote
Copy of the relevant extract of the RFP document issued by the BPC is enclosed and marked as **Annexure-2**, (Page ...17... to Page ...18...) which are integral part of the RFP bidding documents furnished by BPC for bidding.
6. Subsequent to the process of competitive bidding conducted by the BPC, Power Grid Corporation of India Limited has been declared as the successful bidder. The Letter of Intent was issued to Power Grid Corporation of India Limited on 19.09.2024. A copy of the Letter of Intent (LoI) alongwith the details of Annual Transmission Charges is enclosed and marked as **Annexure-3**, (Page ...19... to Page ...23..).
7. As per the provisions 2.15.2 of Request for Proposal (RFP) and the Letter of Intent issued to Power Grid Corporation of India Limited, within 10 days of issuance of Letter of Intent by the BPC, the Successful Bidder is required to inter-alia provide the Contract Performance Guarantee, execute Share Purchase Agreement & the Transmission Service Agreement and acquire the SPV. Vide letters dated 07.11.2024, the BPC in terms of provisio Clause 2.15.2 of RFP has extended the date upto 07.11.2024 for completion of activities by the successful bidder. A copy of the relevant extract of the RFP and the letter from BPC is enclosed and marked as **Annexure-4**, (Page ...24... to Page ...26..).



12

8. That in accordance with the LoI, Power Grid Corporation of India Limited on **07.11.2024** has furnished a Contract Performance Guarantee of Rs. 24.75 Crore (Rupees Twenty Four Crore and Seventy Five lakh Only) in favour of Central Transmission Utility of India Limited (CTUIL).

Power Grid Corporation of India Limited has acquired the **Khavda PS1 and 3 Transmission Limited on 07.11.2024**, after execution of the Share Purchase Agreement, and completing all procedural requirements specified in the RFP documents. A copy of the Share purchase agreement is enclosed and marked as **Annexure – 5, (Page ..~~27~~.... to Page ...~~46~~....)**.

9. A copy of the Transmission Service Agreement (TSA) entered between CTUIL and “**Khavda PS1 and 3 Transmission Limited**” is enclosed and marked as **Annexure-6, (Page ...~~47~~.... to Page ~~203 A (2)~~)**
10. The Applicant shall map Nodal Agency i.e. CTUIL on the e-portal of this Hon'ble Commission at the earliest as per the procedure in vogue and completion of relevant formalities. The Applicant is also sending a copy of the present Petition to CTUIL via e-mail in accordance with the requirement under section 15 (3) of the Electricity Act, 2003 and regulation 5 (3) of Transmission License Regulations, 2024 for its recommendation under section 15 (4) of the Electricity Act, 2003 and regulation 5 (9) of Transmission License Regulations, 2024.
11. That a copy of the Application has also been marked to BPC to enable submission of the requisite documents / information by BPC before this Hon'ble Commission regarding the Bidding process undertaken and thereby ensure processing of application.
12. That a copy of the Application has also been marked to Designated ISTS Customers (DICs) and beneficiaries of the Western Region as party to the Petition based on the list of the DICs and beneficiaries furnished by the CTUIL.
13. The application along with Form-I is being hosted on the website and is accessible on www.powergrid.in/subsidiaries in compliance with Regulation 5 (4) of Transmission License Regulations, 2024. It is undertaken that notice of the Application as per Form-II of Transmission License Regulations shall be posted on the e-filing portal of the Commission and also on the Applicant's website in compliance with Regulation 5 (4) of Transmission License Regulations, 2024. Further, in compliance with regulation 5(5) Transmission License Regulations, 2024, the notice of the Application as per Form-II of Transmission License Regulations shall be published in two leading daily digital newspaper, one in English and another in Gujarati i.e., Indian language of the Gujarat state where the elements of the project are situated for inviting comments from general public. The notice shall also be kept posted on the website of the applicant.
14. It is further undertaken that the petitioner in accordance with Regulation 5(8) of Transmission License Regulations, 2024 shall submit to the commission in affidavit the details of the notice published, names of the digital newspapers in which the notice has



been published, the dates and places of their publication and enclosing the relevant pages of the publication of the notice.

15. That a copy of SLD of the transmission scheme is enclosed and marked as **Annexure -7** (Page ..204.. to Page ..204....).
16. That POWERGRID has acquired the TSP on 07.11.2024 and the same is effective date of the project as per provisions of TSA. The schedule construction period of the project is 24 months. As such Scheduled CoD of the project works out to be 07.11.2026.
17. The applicant is hereby fulfilling the obligations as per 2.15.4 of the RFP documents and all the procedures as stipulated in the CERC (Procedure, Terms and Conditions for grant of Transmission License and other related matters) Regulations, 2024 for grant of Transmission license.
18. Section 14 of the Electricity Act, 2003 (the Act) provides that the Appropriate Commission may, on an application made under section 15 of the Electricity Act, 2003, grant License to any person to transmit electricity as a transmission licensee in any area as may be specified in the License. The word 'person' has been defined in section 2 (49) of the Act to include any company or body corporate or association or body of individuals, whether incorporated or not, or artificial juridical person.
19. Section 15(1) of the Act provides that every application under section 14 shall be made in such manner and in such form as may be specified by the Appropriate Commission and shall be accompanied such fees as may be prescribed. Central Electricity Regulatory Commission has notified Transmission License Regulations (Procedure, Terms and Conditions for Grant of Transmission License and other related matters) and as per Regulation 4 of the aforementioned Regulations, a person selected through the process under the guidelines for competitive bidding is eligible for grant of license.
20. That the applicant - **Khavda PS1 and 3 Transmission Limited** incorporated under the Companies Act, 2013 is a 100% wholly owned subsidiary of Power Grid Corporation of India Limited who has been selected on the basis of the Tariff Based Competitive Bidding as per the Tariff Based Competitive Bidding Guidelines for Transmission Service issued by Govt. of India, Ministry of Power and thus eligible for issuance of transmission license.
21. Duly filled Form 1 for Transmission License in English and Gujarati in accordance with the Transmission License Regulations, 2024 is enclosed herewith and marked as **Annexure-8**, (Page ...205.... to Page ...272....). The notice of the application as per Form-I of Transmission License Regulations, 2024 in English and Gujarati shall be posted on the e-filing portal of the Commission and on the Applicant's website in compliance with Regulation 5 (4) of Transmission License Regulations, 2024
22. That the Transmission Project under reference is governed by the TSA dated 07.11.2024 signed between CTUIL and the Applicant. All the terms of TSA are binding on the signatories of the agreement.

19



That the Applicant would implement the Project as per the provisions of the TSA including the Articles 16.4 (Parties to Perform Obligations), 5.1.1 (TSP's Construction Responsibilities) and 5.4 (Quality of Workmanship).

Further the time over run and cost overrun, if applicable, shall be claimed by the Applicant in accordance with the applicable provisions of the TSA read with the provisions of the Electricity Act 2003, the bidding documents, the regulations of the Central Electricity Regulatory Commission and the exercise of power by Central Electricity Regulatory Commission under the Act and the Regulation.

23. It is submitted that Section 14 of the Electricity Act, 2003 empowers the Appropriate Commission to grant License.

24. PRAYER

It is respectfully prayed that the Hon'ble Commission may be pleased to:

- a) Grant Transmission License to the Applicant ; and
- b) Allow the sharing and recovery of Transmission Charges for Inter-State Transmission System for "Provision of Dynamic Reactive Compensation at Khavda Pooling Station 1 (KPS1) and Khavda Pooling Station 3 (KPS3)" as per Sharing of Inter-state Transmission Charges and Losses CERC Regulations 2020 and any other amendment thereon issued from time to time by CERC.
- c) Pass such other order / orders, as may be deemed fit and proper in the facts & circumstances of the case

Khavda PS1 and 3 Transmission Limited

Applicant

Jain

Represented by Ms. Khushboo Jain

Finance Incharge, Khavda PS1 and 3 Transmission Limited

Place: New Delhi

Date: 07-11-2024



MINISTRY OF POWER

NOTIFICATION

New Delhi, the 12th May, 2023

S.O. 2172(E).—In exercise of the powers conferred by sub-para 3.2 of Para 3 of the Guidelines circulated under Section 63 of the Electricity Act, 2003 (no. 36 of 2003), the Central Government, on recommendations of 12th meeting of National Committee on Transmission, hereby appoints the following Bid-Process Coordinators (BPCs) for the Transmission Schemes, as shown against the name of the Transmission Schemes: -

Sl. No.	Name & Scope of the Transmission Scheme	Bid Process Coordinator						
1.	<p>Provision of Dynamic Reactive Compensation at KPS1 and KPS3</p> <p>Scope:</p> <p>1) ± 300 MVar STATCOM with 1x125 MVar MSC, 2x125 MVar MSR at KPS1, 400 kV Bus section-1 with 1 No. of 400 kV bay (GIS).</p> <p>2) ± 300 MVar STATCOM with 1x125 MVar MSC, 2x125 MVar MSR at KPS1, 400 kV Bus section-2 with 1 No. of 400 kV bay (GIS).</p> <p>3) ± 300 MVar STATCOM with 1x125 MVar MSC, 2x125 MVar MSR at KPS3, 400 kV Bus section-1 with 1 No. of 400 kV bay (GIS).</p> <p>Note:</p> <p>i) TSPs of KPS1 and KPS3 shall provide space for 1 No. 400 kV bay (each) for termination of STATCOM.</p> <p>ii) Land for installation of STATCOM (with MSC/MSR) as specified above has to be arranged by TSP implementing the STATCOM.</p> <p>iii) Implementation Timeframe: 24 months from date of allocation to implementing agency.</p>	PFC Consulting Ltd.						
2.	<p>Transmission System for Evacuation of Power from RE Projects in Rajgarh 1000 MW SEZ in Madhya Pradesh – Phase- II</p> <p>Scope:</p> <table border="1"> <thead> <tr> <th>Sl. No.</th> <th>Scope of the transmission Scheme</th> <th>Capacity /km</th> </tr> </thead> <tbody> <tr> <td>1.</td> <td>400/220 kV, 3x500 MVA ICT augmentation (4th, 5th and 6th) at Pachora PS</td> <td>400/220 kV, 500 MVA ICT – 3 Nos. 400 kV ICT bays – 3 Nos. 220 kV ICT bays – 3 Nos. 400 kV line bays – 2 Nos. 220 kV line bays – 4 Nos. 400 kV Bus Sectionalizer – 1 set 220 kV Bus Sectionalizer – 1 set</td> </tr> </tbody> </table>	Sl. No.	Scope of the transmission Scheme	Capacity /km	1.	400/220 kV, 3x500 MVA ICT augmentation (4 th , 5 th and 6 th) at Pachora PS	400/220 kV, 500 MVA ICT – 3 Nos. 400 kV ICT bays – 3 Nos. 220 kV ICT bays – 3 Nos. 400 kV line bays – 2 Nos. 220 kV line bays – 4 Nos. 400 kV Bus Sectionalizer – 1 set 220 kV Bus Sectionalizer – 1 set	REC Power Development and Consultancy Ltd.
Sl. No.	Scope of the transmission Scheme	Capacity /km						
1.	400/220 kV, 3x500 MVA ICT augmentation (4 th , 5 th and 6 th) at Pachora PS	400/220 kV, 500 MVA ICT – 3 Nos. 400 kV ICT bays – 3 Nos. 220 kV ICT bays – 3 Nos. 400 kV line bays – 2 Nos. 220 kV line bays – 4 Nos. 400 kV Bus Sectionalizer – 1 set 220 kV Bus Sectionalizer – 1 set						



**STANDARD SINGLE STAGE REQUEST FOR PROPOSAL
DOCUMENT**

FOR

**SELECTION OF BIDDER AS TRANSMISSION SERVICE PROVIDER
THROUGH TARIFF BASED COMPETITIVE BIDDING PROCESS**

TO

ESTABLISH INTER-STATE TRANSMISSION SYSTEM

FOR

**PROVISION OF DYNAMIC REACTIVE COMPENSATION AT
KHAVDA POOLING STATION 1 (KPS1) AND KHAVDA POOLING
STATION 3 (KPS3)**

ISSUED BY



(A wholly owned subsidiary of Power Finance Corporation Ltd.)

**Registered Office:
1st Floor, "Urjanidhi", 1, Barakhamba Lane,
Connaught Place, New Delhi-110001**



October 04, 2023

Quoted Transmission Charges of Initial Offer shall be ranked on the basis of ascending order. The Bidders, in the first fifty per cent of the ranking (with any fraction rounded off to higher integer) or four Bidders, whichever is higher, shall qualify for participating in the electronic reverse auction stage and submit their Final Offer.

6. The objective of the bidding process is to select a Successful Bidder pursuant to this RFP, who shall acquire one hundred percent (100%) of the equity shares of **SPV [which is under incorporation]** along with all its related assets and liabilities as per the provisions of the Share Purchase Agreement, at the Acquisition Price to be intimated by the BPC, twenty (20) days prior to the Bid Deadline.

The **SPV [which is under incorporation]**, of which one hundred percent (100%) equity shares will be acquired by the Selected Bidder, shall be responsible as the TSP, for ensuring that it undertakes ownership, financing, development, design, engineering, procurement, construction, commissioning, operation and maintenance of the Project, and to provide Transmission Service as per the terms of the RFP Project Documents.

The TSP shall ensure transfer of all project assets along with substation land, right of way and clearances to CTU or its successors or an agency as decided by the Central Government after 35 years from COD of project at zero cost and free from any encumbrance and liability. The transfer shall be completed within 90 days after 35 years from COD of project failing which CTU shall be entitled to take over the project assets Suo moto.

7. **Commencement of Transmission Service:** The Bidder shall have to commence Transmission Service in accordance with the provisions of the Transmission Service Agreement.
8. **Transmission Charges:** The Transmission Charges shall be payable by the Designated ISTS Customers in Indian Rupees through the CTU as per Central Electricity Regulatory Commission (Sharing of Inter-State Transmission Charges and Losses) Regulations as amended from time to time. Bidders shall quote the Transmission Charges as per the pre-specified structure, as mentioned in the RFP.
9. **Issue of RFP document:** The detailed terms and conditions for qualification and selection of the Transmission Service Provider for the Project and for submission of Bid are indicated in the RFP document. All those interested in purchasing the RFP document may respond in writing to **General Manager, Tel. +91 11 23443996, Fax +91 11 23443990, Email: pfccl.itp@pfcindia.com** at the address given in para 12 below with a non-refundable fee of **Rs. 5,00,000/- (Rupees Five Lakh Only) or US\$ 7000/- (US Dollars Seven Thousand Only)** plus 18% GST, to be paid via electronic transfer to the following Bank Account:

Bank Account Name : PFC Consulting Limited
Account No. : 000705036117
Bank Name : ICICI Bank
IFSC : ICIC0000007
Branch : Connaught Place, New Delhi-110001



Ref. No. 04/24-25/ITP-68/RFP

September 19, 2024

To

Mr. Pankaj Pandey, ED (TBCB)
Power Grid Corporation of India Limited,
"Saudamini" Plot No 2, Sector 29,
Gurgaon-122001

E-mail: ppandey@powergrid.in,
tbcb@powergrid.in

Sub: Independent Transmission Project (ITP) "Provision of Dynamic Reactive Compensation at Khavda Pooling Station 1 (KPS1) and Khavda Pooling Station 3 (KPS3)" – Letter of Intent

Dear Sir,

We refer to:

1. The Request for Proposal document dated 04.10.2023 issued to 'Power Grid Corporation of India Limited' as regards participation in the international competitive bidding process for Transmission Scheme for "Provision of Dynamic Reactive Compensation at Khavda Pooling Station 1 (KPS1) and Khavda Pooling Station 3 (KPS3)", and as amended till the Bid Deadline including all correspondence / clarifications / amendments exchanged between 'Power Grid Corporation of India Limited and PFC Consulting Limited in regard thereto (hereinafter collectively referred to as the "Final RFP");
2. The offer of 'Power Grid Corporation of India Limited' by way of a Technical Bid pursuant to (1) above submitted on 01.05.2024 in response to the Final RFP.
3. The offer of 'Power Grid Corporation of India Limited' by way of Financial Bid-Initial Offer submitted on 01.05.2024 in response to the Final RFP.
4. The offer of 'Power Grid Corporation of India Limited' by way of a Financial Bid-Final Offer Submitted during e-Reverse Auction process concluded on 03.07.2024 in response to the Final RFP.
5. The Technical Bid as in (2) above and the Financial Bid as in (3 & 4) above, hereinafter collectively referred to as the "Bid".

This is to inform you that the process of evaluating bids received pursuant to the Final RFP, including the Bid, has been concluded. We are pleased to inform you that your proposal and offer received by way of the "Bid" has been accepted and 'Power Grid Corporation of India Limited' is

ATTESTED TRUE COPY

Attested from Pg 19 - Pg 23



Authorised Signatory

Power Grid Corporation of India Limited

Regd. Office : 9th Floor, "Saudamini", 1, Barakhamba Lane, Connaught Place, New Delhi-110001

कंपनी मुख्यालय : नौवौं तल, (ए विंग), स्टेट्समैन हाउस, बाराखम्बा रोड, कनॉट प्लेस, नई दिल्ली-110001 दूरभाष : 011-23443900 फैक्स : 011-23443990
Corporate Office : 9th Floor (A-Wing), Statesman House, Connaught Place, New Delhi-110001 Phone : 011-23443900 Fax : 011-23443990
फैक्स / Website : www.pfcclindia.com / www.pfcindia.com • CIN : U74140DL2008GOI175858

herby declared as the Successful Bidder as per Clause 3.6.1 of the Final RFP for the above project and consequently, this Letter of Intent (hereinafter referred to as the "LoI") is being issued.

This LoI is based on the Final RFP and you are requested to please comply with the following:

- a) Acknowledging its issuance and unconditionally accepting its contents and recording "Accepted unconditionally" under the signature of your authorized signatory on each page of the duplicate copy of this letter attached herewith, and returning the same to PFC Consulting Limited within seven (07) days of the date of issuance of LoI. This LoI is issued to you in duplicate.
- b) Completion of various activities as stipulated in the Final RFP including in particular Clause 2.15.2, Clause 2.15.3 and Clause 2.15.4 of the Final RFP, within the timelines as prescribed therein.

It may be noted that PFC Consulting Limited has the rights available to them under the Final RFP, including rights under Clause 2.15.5 and Clause 3.6.3 thereof, upon your failure to comply with the aforementioned conditions.

As you are aware, the issuance and contents of this LoI are based on the Bid submitted by you as per the Final RFP including the Transmission charges and other details regarding the Scheduled COD as contained therein. The Quoted Transmission Charges as submitted by you and the Scheduled COD of each transmission Element and the Project as agreed by you in your Bid, as per Annexure 21 and Format-1 of Annexure 8 respectively of the Final RFP is annexed herewith as **Schedule A** and incorporated herein by way of reference.

Yours sincerely,
For PFC Consulting Limited

(Naveen Kumar)
General Manager

Enclosures: Schedule A – Quoted Transmission Charges and the Scheduled COD of each Transmission Element and the Project submitted in your Bid, as per Annexure 21 and Format-1 of Annexure 8 respectively of the Final RFP



Copy to:

1. **Chairperson and Managing Director, Power Finance Corporation Limited, "Urjanidhi", I, Barakhamba Lane, Connaught Lane, New Delhi - 110 001**
2. **Director (Transmission), Ministry of Power, Shram Shakti Bhawan, Rafi Marg, New Delhi- 110001**
3. **Chief Engineer (PSPA-I) and Member Secretary (NCT), Central Electricity Authority, 3rd Floor, Sewa Bhawan, R.K. Puram, New Delhi - 110066**
4. **Chief Operating Officer (COO), Central Transmission Utility of India Limited (CTUIL), "Saudamini", Plot No. 2, Sector - 29, Gurgaon, Haryana - 122001**
5. **Secretary, Central Electricity Regulatory Commission, 3rd & 4th Floor, Chanderlok Building, 36, Janpath, New Delhi - 110 001**



[Handwritten signature]

1. Quoted Transmission Charges as per Annexure-21-Format For Financial Bid

Quoted Transmission Charges: Rs. 1,077.25 million per annum



2. Scheduled COD of each transmission Element and the Project as per Format 1 of Annexure-8 of RFP

Sl. No.	Name of the Transmission Element	Scheduled COD	Percentage of Quoted Transmission Charges recoverable on Scheduled COD of the Element of the Project	Element(s) which are pre-required for declaring the commercial operation (COD) of the respective Element
1.	± 300 MVAR STATCOM with 1x125 MVAR MSC, 2x125 MVAR MSR at KPS1, 400 kV Bus section-1 with 1 No. of 400 kV bay (GIS)	24 months from the date of SPV acquisition	33.334%	-
2.	± 300 MVAR STATCOM with 1x125 MVAR MSC, 2x125 MVAR MSR at KPS1, 400 kV Bus section-2 with 1 No. of 400 kV bay (GIS)		33.333%	-
3.	± 300 MVAR STATCOM with 1x125 MVAR MSC, 2x125 MVAR MSR at KPS3 400 kV Bus section-1 with 1 No. of 400 kV bay (GIS)		33.333%	-

JAC



**STANDARD SINGLE STAGE REQUEST FOR PROPOSAL
DOCUMENT**

FOR

**SELECTION OF BIDDER AS TRANSMISSION SERVICE PROVIDER
THROUGH TARIFF BASED COMPETITIVE BIDDING PROCESS**

TO

ESTABLISH INTER-STATE TRANSMISSION SYSTEM

FOR

**PROVISION OF DYNAMIC REACTIVE COMPENSATION AT
KHAVDA POOLING STATION 1 (KPS1) AND KHAVDA POOLING
STATION 3 (KPS3)**

ISSUED BY



(A wholly owned subsidiary of Power Finance Corporation Ltd.)

**Registered Office:
1st Floor, "Urjanidhi", 1, Barakhamba Lane,
Connaught Place, New Delhi-110001**

ATTESTED TRUE COPY



October 04, 2023

to above, the following documents have also been attached to this RFP:

- a) Share Purchase Agreement

When the drafts of the above RFP Project Documents are provided by the BPC, these RFP Project Documents shall form part of this RFP as per Formats – 1 & 2 of Annexure 20.

Upon finalization of the RFP Project Documents after incorporating the amendments envisaged in Clause 2.4 of this RFP, all the finalized RFP Project Documents shall be provided by BPC to the Bidders at least fifteen (15) days prior to the Bid Deadline.

The Transmission Service Agreement and Share Purchase Agreement shall be signed in required number of originals so as to ensure that one (1) original is retained by each party to the Agreement(s) on the date of transfer of SPV.

2.15.2. Within ten (10) days of the issue of the Letter of Intent, the Selected Bidder shall:

- a) Provide the Contract Performance Guarantee in favour of the Nodal Agency as per the provisions of Clause 2.12;
- b) Execute the Share Purchase Agreement and the Transmission Service Agreement;
- c) acquire, for the Acquisition Price, one hundred percent (100%) equity shareholding of **SPV [which is under incorporation]** from PFC Consulting Limited, who shall sell to the Selected Bidder, the equity shareholding of **SPV [which is under incorporation]**, along with all its related assets and liabilities;

Stamp duties payable on purchase of one hundred percent (100%) of the equity shareholding of **SPV [which is under incorporation]**, along with all its related assets and liabilities, shall also be borne by the Selected Bidder.

Provided further that, if for any reason attributable to the BPC, the above activities are not completed by the Selected Bidder within the above period of ten (10) days as mentioned in this Clause, such period of ten (10) days shall be extended, on a day for day basis till the end of the Bid validity period.

2.15.3. After the date of acquisition of the equity shareholding of **SPV [which is under incorporation]**, along with all its related assets and liabilities, by the Selected Bidder,

- i. the authority of the BPC in respect of this Bid Process shall forthwith cease and any actions to be taken thereafter will be undertaken by the Nodal Agency,
- ii. all rights and obligations of **SPV [which is under incorporation]**, shall be of the TSP,
- iii. any decisions taken by the BPC prior to the Effective Date shall continue to be binding on the Nodal Agency and
- iv. contractual obligations undertaken by the BPC shall continue to be fulfilled by the TSP.

- v. Further, the TSP shall execute the Agreement(s) required, if any, under Central Electricity Regulatory Commission (Sharing of Inter-State Transmission Charges and Losses) Regulations as amended from time to time.
- 2.15.4. Within five (5) working days of the issue of the acquisition of the SPV by the Successful Bidder, the TSP shall apply to the Commission for grant of Transmission License and make an application to the Commission for the adoption of Transmission Charges, as required under Section – 63 of The Electricity Act 2003.
- 2.15.5. If the Selected Bidder / TSP fails or refuses to comply with any of its obligations under Clauses 2.15.2, 2.15.3 and 2.15.4, and provided that the other parties are willing to execute the Share Purchase Agreement and PFC Consulting Limited is willing to sell the entire equity shareholding of SPV [which is under incorporation], along with all its related assets and liabilities, to the Selected Bidder, such failure or refusal on the part of the Selected Bidder shall constitute sufficient grounds for cancellation of the Letter of Intent. In such cases, the BPC / its authorized representative(s) shall be entitled to invoke the Bid Bond of the Selected Bidder.
- 2.15.6. If the TSP fails to obtain the Transmission License from the Commission, it will constitute sufficient grounds for annulment of award of the Project.
- 2.15.7. The annulment of award, as provided in Clauses 2.15.5 and 2.15.6 of this RFP, will be done by the Government on the recommendations of National Committee on Transmission. However, before recommending so, National Committee on Transmission will give an opportunity to the Selected Bidder / TSP to present their view point.
- 2.15.8. The annulment of the award, under Clause 2.15.5 or 2.15.6 of this RFP, shall be sufficient grounds for blacklisting the bidder, whose award has been annulled, for a period of five years or more, as decided by the National Committee on Transmission, provided that the blacklisting shall be done only after giving the bidder an opportunity for showing cause.

2.16 Confidentiality

- 2.16.1. The parties undertake to hold in confidence this RFP and RFP Project Documents and not to disclose the terms and conditions of the transaction contemplated hereby to third parties, except:
- a) to their professional advisors;
 - b) to their officers, contractors, employees, agents or representatives, financiers, who need to have access to such information for the proper performance of their activities;
 - c) disclosures required under Law, without the prior written consent of the other parties of the concerned agreements.

Provided that the TSP agrees and acknowledges that the Nodal Agency may at any time, disclose the terms and conditions of the RFP and RFP Project Documents to any person, to the extent stipulated under the Law or the Bidding Guidelines.



Ref. No. 04/24-25/ITP-68/RFP

November 07, 2024

To
Power Grid Corporation of India Limited,
"Saudamini" Plot No 2, Sector 29,
Gurgaon-122001

Email: kaushalkishore@powergrid.in

Kind Attn.: Mr. Kaushal Kishor

Sub: Independent Transmission Project "Provision of Dynamic Reactive Compensation at Khavda Pooling Station 1 (KPS1) and Khavda Pooling Station 3 (KPS3)" – Regarding extension of LoI.

Dear Sir,

This is with reference to Letter of Intent (LoI) issued on September 19, 2024 for establishment of subject transmission scheme. The Clause No. 2.15.2 of the RFP document stipulates that within ten (10) days of the issue of the LoI the selected bidder shall complete all the activities including the acquisition of SPV.

As the SPV is being transferred on November 07, 2024 the last date for completion of various activities under Clause No. 2.15.2 of the RFP document is extended from September 29, 2024 (10 days from LoI) to November 07, 2024.

Thanking you,

Yours faithfully,

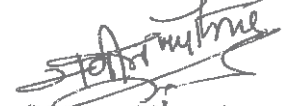

(Naveen Kumar)
General Manager



Dated 07th November, 2024

SHARE PURCHASE AGREEMENT

BETWEEN

PFC CONSULTING LIMITED

AND

KHAVDA PS1 AND 3 TRANSMISSION LIMITED

AND

POWER GRID CORPORATION OF INDIA LIMITED

ATTESTED TRUE COPY
Attested from
Pg 27 - Pg 46
Authorised Signatory
KHAVDA PS1 AND 3 TRANSMISSION LIMITED



Sachin Arora
Digitally signed by Sachin Arora
Date: 2024.11.07
18:51:20 +05'30'

PFCCCL

Neeraj Singh
Digitally signed by Neeraj Singh
Date: 2024.11.07
18:43:59 +03'30'

KPS137L

SATYAPRAK ASH DASH
Digitally signed by SATYAPRAKASH DASH
Date: 2024.11.07
19:16:49 +05'30'

PGCIL

27

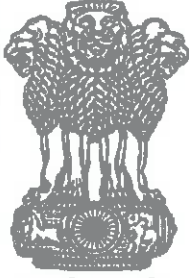

सत्यमेव जयते

INDIA NON JUDICIAL

Government of National Capital Territory of Delhi

₹200

e-Stamp

Certificate No. : IN-DL82356141523330W
Certificate Issued Date : 07-Nov-2024 01:19 PM
Account Reference : IMPACC (IV)/dl960303/ DELHI/ DL-DLH
Unique Doc. Reference : SUBIN-DL96030313453789189560W
Purchased by : PFC CONSULTING LIMITED
Description of Document : Article 5 General Agreement
Property Description : Not Applicable
Consideration Price (Rs.) : 0
 (Zero)
First Party : PFC CONSULTING LIMITED
Second Party : Not Applicable
Stamp Duty Paid By : PFC CONSULTING LIMITED
Stamp Duty Amount(Rs.) : 200
 (Two Hundred only)

₹200 ₹200 ₹200 ₹200

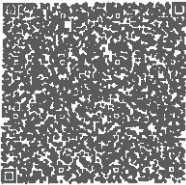

Please write or type below this line IN-DL82356141523330W

This Stamp Paper Forms Part of enclosed Share Purchase Agreement executed between PFC CONSULTING LIMITED, KHAVDA PS1 AND 3 TRANSMISSION LIMITED and POWER GRID CORPORATION OF INDIA LIMITED.

Sachin Arora Digitally signed by Sachin Arora Date: 2024.11.07 18:51:44 +05'30'

Neera Singh Digitally signed by Neera Singh Date: 2024.11.07 18:44:41 +05'30'

SATYAPRAK ASH DASH Digitally signed by SATYAPRAKASH DASH Date: 2024.11.07 19:19:14 +05'30'

Statutory Alert:

1. The authenticity of this Stamp certificate should be verified at 'www.shclsestamp.com' or using e-Stamp Mobile App of Stock Holding. Any discrepancy in the details on this Certificate and as available on the website / Mobile App renders it invalid.
2. The onus of checking the legitimacy is on the users of the certificate.
3. In case of any discrepancy please inform the Competent Authority.

28

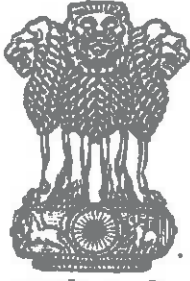

सत्यमेव जयते

INDIA NON JUDICIAL

Government of National Capital Territory of Delhi

₹500

e-Stamp

Certificate No.	: IN-DL82368385303885W
Certificate Issued Date	: 07-Nov-2024 01:31 PM
Account Reference	: IMPACC (IV)/ di960303/ DELHI/ DL-DLH
Unique Doc. Reference	: SUBIN-DL DL96030313483087044578W
Purchased by	: PFC CONSULTING LIMITED
Description of Document	: Article 5 General Agreement
Property Description	: Not Applicable
Consideration Price (Rs.)	: 0 (Zero)
First Party	: PFC CONSULTING LIMITED
Second Party	: Not Applicable
Stamp Duty Paid By	: PFC CONSULTING LIMITED
Stamp Duty Amount(Rs.)	: 500 (Five Hundred only)

सत्यमेव जयते

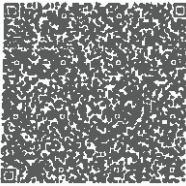

Please write or type below this line

IN-DL82368385303885W

This Stamp Paper Forms Part of enclosed Share Purchase Agreement executed between PFC CONSULTING LIMITED, KHAVDA PS1 AND 3 TRANSMISSION LIMITED and POWER GRID CORPORATION OF INDIA LIMITED.

Sachin Arora

Digitally signed by Sachin Arora Date: 2024.11.07 18:52:10 +05'30'



Neeraj Singh

Digitally signed by Neeraj Singh Date: 2024.11.07 18:44:56 +05'30'

SATYAPRAKASH DASH

Digitally signed by SATYAPRAKASH DASH Date: 2024.11.07 19:20:57 +05'30'

Statutory Alert:

1. The authenticity of this Stamp certificate should be verified at 'www.shcilestamp.com' or using e-Stamp Mobile App of Stock Holding. Any discrepancy in the details on this Certificate and as available on the website / Mobile App renders it invalid.
2. The onus of checking the legitimacy is on the users of the certificate.
3. In case of any discrepancy please inform the Competent Authority.

₹500 ₹500 ₹500 ₹500

29

SHARE PURCHASE AGREEMENT

This **SHARE PURCHASE AGREEMENT** ('Agreement') made this 07th November, 2024 at New Delhi by and between:

PFC CONSULTING LIMITED (a wholly owned subsidiary of Power Finance Corporation Ltd.), a company incorporated under the Companies Act, 1956, with CIN No. U74140DL2008GOI175858, having its registered office at First Floor, "Urjanidhi", 1 Barakhamba Lane, Connaught Place, New Delhi 110001, (hereinafter referred to as "**PFCC**", which expression shall, unless it be repugnant to the context or meaning thereof, be deemed to mean and include its successors and permitted assigns) of the **FIRST PART**;

AND

KHAVDA PS1 AND 3 TRANSMISSION LIMITED, a company incorporated under the Companies Act, 2013, with CIN no. U42201DL2023GOI424248 having its registered office at First Floor, "Urjanidhi", 1 Barakhamba Lane, Connaught Place, New Delhi 110001, (hereinafter referred to as "**Company**" which expression shall, unless repugnant to the context or meaning thereof, be deemed to mean and include its successors and permitted assigns) of the **SECOND PART**;

AND

POWER GRID CORPORATION OF INDIA LIMITED, a company incorporated under the Companies Act, 1956 with CIN No. L40101DL1989GOI038121 having its registered office B-9, Qutab Institutional Area, Katwaria Sarai, New Delhi-110016 (hereinafter referred to as "**Selected Bidder**" which expression shall, unless repugnant to the context or meaning thereof, be deemed to mean and include its successors and permitted assigns) of the **THIRD PART**.

WHEREAS:

- A. The Government of India, Ministry of Power, vide its gazette notification no **CG-DL-E-13052023-245856** date **May 12, 2023** has notified PFC Consulting Limited (PFCC) to be the Bid Process Coordinator (BPC) for the purpose of selection of Bidder as Transmission Service Provider (TSP) to establish Inter-State transmission system for "**Provision of Dynamic Reactive Compensation at Khavda Pooling Station 1 (KPS1) and Khavda Pooling Station 3 (KPS3)**" through tariff based competitive bidding process (hereinafter referred to as the "Project")
- B. In accordance with the Bidding Guidelines, PFCC had initiated a Bid Process through issuance of RFP documents for selecting a Successful Bidder to build, own, operate and transfer the Project in accordance with and on the terms and conditions mentioned in the RFP Project Documents (as defined hereinafter).

Sachin Arora
Digitally signed by Sachin Arora
Date: 2024.11.07 18:53:37 +05'30'



Neera Singh
Digitally signed by Neera Singh
Date: 2024.11.07 18:45:19 +05'30'

SATYAPRAKASH DASH
Digitally signed by SATYAPRAKASH DASH
Date: 2024.11.07 19:25:12 +05'30'

PFCC

KPS13TL

PGCIL

1

31

- C. PFCCCL has incorporated the Company and PFCCCL along with the Nominees hold One hundred per cent (100 %) of total issued and paid up equity share capital of the Company.
- D. PFCCCL has initiated the development of the Project and has obtained survey report, certain clearances, consents and permits as specified in the RFP regarding the Project.
- E. Pursuant to the said Bid Process, Power Grid Corporation of India Limited has been identified as the Selected Bidder vide Letter of Intent dated 19.09.2024 issued by the PFCCCL in favor of the Selected Bidder.
- F. As envisaged in the RFP, the Shares Seller (as defined hereinafter) has agreed to sell the Sale Shares (as defined hereinafter) to the Selected Bidder and the Selected Bidder has agreed to purchase the Sale Shares from the Shares Seller, subject to and on the terms and conditions set forth in this Agreement.

NOW THEREFORE, IN CONSIDERATION OF THE MUTUAL COVENANTS AND AGREEMENTS SET FORTH IN THIS AGREEMENT AND FOR OTHER GOOD AND VALUABLE CONSIDERATION, THE PARTIES HEREBY AGREE AS FOLLOWS:

1. DEFINITIONS

1.1 Capitalised terms in this Agreement, unless defined in this Agreement shall, in so far as the context admits, have the same meaning in this Agreement as has been ascribed to them in the Transmission Service Agreement.

1.2 Additionally, the following terms shall have the meaning hereinafter respectively assigned to them herein below:

(i) **“Acquisition Price”** shall mean **Rs. 7,92,07,752/- (Rupees Seven Crore Ninety Two Lakh Seven Thousand Seven Hundred and Fifty Two Only Only)**, which is the aggregate consideration payable by the Selected Bidder towards purchase of the **Sale Shares at par** along with assets and liabilities of the Company as on the Closing Date subject to adjustment as per the audited accounts of the Company as on the Closing Date;

(ii) **“Agreement”** or **“the Agreement”** or **“this Agreement”** shall mean this Share Purchase Agreement and shall include the recitals and/or annexures attached hereto, and the contracts, certificates, disclosures and other documents to be executed and delivered pursuant hereto, if any, and any amendments made to this Agreement by Parties in writing;

Sachin Arora
Digitally signed by Sachin Arora
Date: 2024.11.07 18:53:59 +05'30'

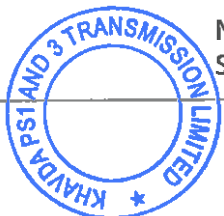

Neeraj Singh
Digitally signed by Neeraj Singh
Date: 2024.11.07 18:45:32 +05'30'

SATYAPRAK ASH DASH
Digitally signed by SATYAPRAKASH DASH
Date: 2024.11.07 19:28:35 +05'30'

32

- (iii) **"Bid Process"** shall mean the competitive bidding process initiated by the BPC, by issuance of RFP Documents for selecting a Successful Bidder to build, own, operate and transfer the Project in accordance with and on the terms and conditions mentioned in the RFP Project Documents;
- (iv) **"Board"** shall mean the board of directors of the Company
- (v) **"Closing Date"** shall mean a mutually agreed date between the Parties falling within the period as mentioned in Clause 2.15.2 of RFP or on failure of such mutual agreement between the Parties shall be the date falling on the last date of such period;
- (vi) **"CTU" or "Central Transmission Utility of India Limited"** shall have same meaning as defined in the Electricity Act, 2003;
- (vii) **"Encumbrance"** shall mean any mortgage, pledge, lien, charge, security assignment, hypothecation, trust, encumbrance or any other agreement having the effect of creating security interest;
- (viii) **"Letter of Intent"** shall have the meaning ascribed thereto under the RFP;
- (ix) **"Nominees"** shall mean the Persons, who are named in Annexure A, holding the Sale Shares as nominees of PFCCL.
- (x) **"Party"** shall mean PFCCL, Company and the Selected Bidder, referred to individually, and **"Parties"** shall mean PFCCL, Company and the Selected Bidder collectively referred to, as relevant;
- (xi) **"Person"** shall include an individual, an association, a corporation, a partnership, a joint venture, a trust, an unincorporated organisation, a joint stock company or other entity or organisation, including a government or political subdivision, or an agency or instrumentality thereof, and/or any other legal entity;
- (xii) **"RfP Project Documents"** shall mean the following documents, referred to collectively:
- Transmission Services Agreement;
 - this Agreement; and
 - Any other agreement(s) as may be required.
- (xiii) **"Representations and Warranties"** shall mean the representations and warranties mentioned in Clause 4 hereto;

Sachin Arora
Digitally signed by Sachin Arora
Date: 2024.11.07
18:54:21 +05'30'



Neeraj Singh
Digitally signed by Neeraj Singh
Date: 2024.11.07
18:45:46 +05'30'

SATYAPRAKASH DASH
Digitally signed by SATYAPRAKASH DASH
Date: 2024.11.07
19:31:04 +05'30'

33

- (xiv) "Sale Shares" shall mean 10,000 (Ten Thousand) Shares, representing 100 percent of the total issued, subscribed and fully paid-up equity share capital of the Company held by the Shares Seller and Nominees as more particularly described in Annexure A attached hereto;
- (xv) "Shares" shall mean the fully paid-up equity shares of Company, of face value Rs. 10 each;
- (xvi) "Shares Seller" shall mean PFCCL;
- (xvii) "Transmission Services Agreement" or "TSA" means the agreement titled 'Transmission Services Agreement' dated 07th November, 2024 entered into between Central Transmission Utility of India Limited and the Khavda PS1 and 3 Transmission Limited (TSP) pursuant to which the TSP shall build, own, operate and transfer the Project and make available the assets of the Project to Central Transmission Utility of India Limited on a commercial basis, as may be amended from time to time;
- (xviii) "Transmission Service Provider" or "TSP" shall mean Khavda PS1 and 3 Transmission Limited which has executed the Transmission Service Agreement and which shall be acquired by the Selected Bidder.

1.3 Interpretation Clause

Unless the context otherwise requires, the provisions of the TSA relating to the interpretation of the TSA shall apply to this Agreement as if they were set out in full in this Agreement and to this end are incorporated herein by reference.

2. TRANSFER OF SHARES

- 2.1 Subject to the terms and conditions of this Agreement, the Shares Seller agrees to sell and transfer to the Selected Bidder and the Selected Bidder hereby agrees to purchase from the Shares Seller, the Sale Shares of the Company free from Encumbrances with rights and benefits attached thereto in consideration of the Acquisition Price and the covenants, undertakings and the agreements of the Selected Bidder contained in this Agreement.
- 2.2 The Shares Seller hereby undertakes to cause the Nominees to transfer part of the Sale Shares held by them as Nominees of the Shares Seller to the Selected Bidder and execute any documents required to deliver good title to the Sale Shares to the Selected Bidder.

Sachi
n
Arora

Digitally
signed by
Sachin Arora
Date:
2024.11.07
18:54:46
+05'30'

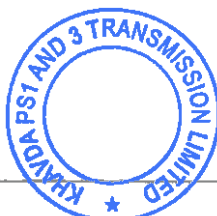

Neeraj
Singh

Digitally signed
by Neeraj Singh
Date: 2024.11.07
18:46:11 +05'30'

SATYAPRAK
ASH DASH

Digitally signed by
SATYAPRAKASH DASH
Date: 2024.11.07
19:32:18 +05'30'

3. CLOSING

- 3.1 Prior to the Closing Date, the Selected Bidder shall provide to the Shares Seller, valid share transfer forms ("Share Transfer Forms") duly stamped with requisite amount of stamp duty payable on the transfer of Sale Shares.
- 3.2 On the Closing Date, the Shares Seller shall hand over to the Selected Bidder or its authorised representative, the original share certificates representing the Sale Shares ("Sale Share Certificates") along with the Share Transfer Forms duly executed by the Shares Seller and the Nominees in favour of the Selected Bidder, simultaneously against the Selected Bidder handing over to the Shares Seller demand drafts drawn in favour of the Shares Seller for the Acquisition Price payable to it.

Provided that prior to the handing over of the Sale Share Certificates to the Selected Bidder as mentioned above, the Selected Bidder shall provide satisfactory evidence to PFCCCL that on or before the Closing Date, the Selected Bidder has furnished the Performance Bank Guarantee to Central Transmission Utility of India Limited and is in a position to comply with all other requirements of Clause 2.15.2 of the RFP.

- 3.3 The Selected Bidder shall immediately upon receiving the Sale Share Certificates and the Share Transfer Forms, duly execute the Share Transfer Forms and duly lodge the Share Transfer Forms and the Sale Share Certificates with the Company. The Selected Bidder may also propose the names of its nominees to be appointed on the Board of the Company and the address within the jurisdiction of the Registrar of Companies NCT of Delhi and Haryana, which would be the new registered office of the Company. The Company shall, upon receipt of the said documents from the Selected Bidder, do the following:

- (i) Immediately on the Closing Date convene a meeting of the Board, wherein the Board shall pass the following necessary resolutions:
- (a) approving the transfer of the Shares constituting the Sale Shares from the Shares Seller and the Nominees to the name of the **Power Grid Corporation of India Limited and its nominees and transfer of all assets and liabilities of the Company as on Closing Date;**
- (b) approving the **Power Grid Corporation of India Limited and its nominees** as a member of the Company and entering the name of the **Power Grid Corporation of India Limited and its nominees** in the register of members.
- (c) changing the address of the registered office of the Company to the new address, within the jurisdiction of the Registrar of Companies NCT of Delhi and Haryana, as may be provided by the Selected Bidder.

Sachin Arora
Digitally signed by Sachin Arora
Date: 2024.11.07 18:55:10 +05'30'

Neeraj Singh
Digitally signed by Neeraj Singh
Date: 2024.11.07 18:46:26 +05'30'

SATYAPRAK ASH DASH
Digitally signed by SATYAPRAKASH DASH
Date: 2024.11.07 19:33:36 +05'30'

PFCCCL



KPS13TL

PGCIL

- (d) appointing the nominees of the Selected Bidder on the Board and accepting the resignations of the other existing Directors on the Board and the Chair of the meeting which was taken by one of the existing Directors shall be vacated and appointment of a new Chairman who shall be one of the newly appointed Director, for the rest of the meeting.

Pursuant to the acceptance of resignation of the existing Directors and appointment of new Chairman, the newly constituted Board of Directors shall hold the meeting and pass the following resolution:

- (e) terminating all the authorizations granted regarding the business and/or operations of the Company or the operations of the bank accounts of the Company, with prospective effect; and
- (f) acknowledging and accepting the terms and conditions as contained in the executed copies of the RFP Project Documents and to abide by the provisions contained therein.
- (ii) Enter the name of the **Power Grid Corporation of India Limited and its nominees** as the legal and beneficial owner of the Sale Shares, free of all Encumbrances, in the register of members of the Company;
- (iii) Make the necessary endorsements on the Sale Share Certificates, indicating the name of the **Power Grid Corporation of India Limited and its nominees** as the legal and beneficial owner of the Sale Shares evidenced there under;
- (iv) Return the original Sale Share Certificates, duly endorsed in the name of the **Power Grid Corporation of India Limited and its nominees**, to the **Power Grid Corporation of India Limited and its nominees**, as the case may be or its authorised representative;
- (v) Handover all the statutory registers and records, if any, of the Company to the Selected Bidder.
- (vi) Handover certified true copies of the Board resolution passed by the Company as per (i)(a) to (i)(e) of Clause 3.3 (i) to Central Transmission Utility of India Limited.

3.4 The Parties to this Agreement agree to take all measures that may be required to ensure that all the events contemplated in the **Clauses 3.1 to 3.3** above on the Closing Date are completed on the same day.

Notwithstanding the provisions of **Clause 3.3** hereto, all proceedings to be taken and all documents to be executed and delivered by the Parties at the Closing Date shall be

Sachin Arora
Digitally signed by Sachin Arora
Date: 2024.11.07
18:55:35 +05'30'

Neera Singh
Digitally signed by Neera Singh
Date: 2024.11.07
18:46:40 +05'30'

SATYAPRAK ASH DASH
Digitally signed by SATYAPRAKASH DASH
Date: 2024.11.07
19:34:46 +05'30'

PFCL

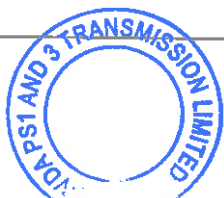

KPS137L

26

PGCIL

deemed to have been taken and executed simultaneously and no proceedings shall be deemed to have been taken nor documents executed or delivered until all have been taken, executed and delivered.

- 3.5 The Selected Bidder hereby acknowledges and agrees that after the date of acquisition of one hundred percent (100%) of the equity shareholding of the Company, by the Selected Bidder as per Clause 3.3, (a) the authority, rights and obligations of the PFCCCL/Company in respect of the Bid Process shall forthwith cease and any actions to be taken thereafter regarding the Bid Process will be undertaken by Central Transmission Utility of India Limited themselves or through their any other authorized representative(s), (b) all rights and obligations of the PFCCCL/Company shall be of the Selected Bidder and (c) any decisions taken by the PFCCCL/Company prior to the date of its acquisition by the Selected Bidder shall continue to be binding on the Selected Bidder. The Parties hereby agree that this provision shall survive the termination of this Agreement.
- 3.6 This agreement shall be effective from the date of its signing by the Parties and shall remain in force until all the obligations of the respective Parties under Clause 3.3 hereto are fulfilled.

4. REPRESENTATIONS AND WARRANTIES

4.1 The Selected Bidder hereby represents and warrants to the Shares Seller that:

- 4.1.1 The Selected Bidder has full legal right, power and authority to enter into, execute and deliver this Agreement and to perform the obligations, undertakings and transactions set forth herein, and this Agreement has been duly and validly executed and delivered by the Selected Bidder and constitutes its legal, valid and binding obligations, enforceable against it in accordance with its terms;
- 4.1.2 The execution, delivery and performance of this Agreement by the Selected Bidder (i) will not violate or contravene any provision of the Memorandum of Association or Articles of the Selected Bidder, (ii) will not violate or contravene any law, statute, rule, regulation, licensing requirement, order, writ, injunction or decree of any court, governmental instrumentality or other regulatory, governmental or public body, agency or authority by which the Selected Bidder are bound or by which any of its and/or their properties or assets are bound, and (iii) except to the extent that the same have been duly and properly completed or obtained, will not require any filing with, or permit, consent or approval of or license from, or the giving of any notice to, any court, governmental instrumentality or other regulatory, governmental or public body, agency or authority, joint venture party, or any other entity or person whatsoever; and

Digitally signed
by Sachin Arora
Date: 2024.11.07
18:55:59
+05'30'

Sachin
Arora

PFCCCL



Digitally signed
by Neeraj Singh
Date: 2024.11.07
18:46:55 +05'30'

Neeraj
Singh

KPS1371

Digitally signed by
SATYAPRAKASH DASH
Date: 2024.11.07
19:35:58 +05'30'

SATYAPRAK
ASH DASH

PGCIL

Handwritten signature or initials.

- 4.1.3 The Selected Bidder is not restricted in any manner whatsoever, including without limitation, on account of any judicial or governmental order, action or proceeding, or any contractual obligation assumed by the Selected Bidder, from purchasing the Sale Shares from the Shares Seller in the manner provided for in this Agreement.
- 4.2 The Shares Seller hereby represents and warrants to the Selected Bidder that;
- 4.2.1 The Shares Seller and the Nominees are the legal and beneficial owners of the Sale Shares, free and clear of any Encumbrance and the delivery to the Selected Bidder of the Sale Shares pursuant to the provisions of this Agreement will transfer to the Selected Bidder a good title to the Sale Shares.
- 4.2.2 The Shares Seller has full legal right, power and authority to enter into, execute and deliver this Agreement and to perform the obligations, undertakings and transactions set forth herein. The execution, delivery and performance of this Agreement will not violate the Memorandum and Articles of Association of the Shares Seller or contravene any contract by which it is bound.
- 4.2.3 The Shares Seller has obtained requisite authorizations to sell and transfer the Sale Shares to the Selected Bidder. The Shares Seller also represent that it is not prevented from transferring and selling the Sale Shares. Also, to the best of its knowledge, the Sale Shares are not the subject matter of any claim or pending proceeding or threatened by any legal proceeding made by any third party.
- 4.3 Except as specified in Clause 4.2, above the Shares Seller shall not be deemed to have, made any representation or warranty whatsoever, whether express or implied, in relation to the Sale Shares or Company, including but not limited to any implied warranty or representation as to the business or affairs of the Company.
- 4.4 The Representations and Warranties are given as at the date of this Agreement except that where a Representation and Warranty is expressed to be made as at another date, the Representation and Warranty is given with respect to that date only.
- 4.5 Each Representation and Warranty is to be construed independently of the others and is not limited by reference to any other Warranty. The Representations, Warranties and undertakings contained in this Clause 4 hereto or in any document delivered pursuant to or in connection with this Agreement are continuing in nature and shall survive the Closing Date for one (1) year.
- 4.6 The Parties represent to each other that all Representations and Warranties provided herein by the respective Party shall be true as of Closing Date.

Sachin Arora
Digitally signed by Sachin Arora
Date: 2024.11.07 18:56:24 +05'30'

PFCL

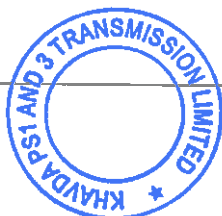

Neeraj Singh
Digitally signed by Neeraj Singh
Date: 2024.11.07 18:47:08 +05'30'

KPS137L

SATYAPRAKASH DASH
Digitally signed by SATYAPRAKASH DASH
Date: 2024.11.07 19:37:10 +05'30'

38

PGCIL

5. OBLIGATIONS OF THE SELECTED BIDDER

The Selected Bidder agrees that the Shares Seller shall not be liable in any manner, nor shall it assume any responsibility or liability whatsoever, in respect of the business of the Company and its operations or activities, arising after Closing Date, to any Person or any authority, central, state, local or municipal or otherwise and the same shall be the sole responsibility of the Selected Bidder.

6. MISCELLANEOUS

6.1 NOTICES

- a) All notices to be given under this Agreement shall be in writing and in the English language.
- b) All notices must be delivered personally or by registered or speed post or by recognised courier to the addresses below:

Selected Bidder (Lead Member in case of Consortium)	Power Grid Corporation of India Limited B-9, Qutab Institutional Area, Katwaria Sarai, New Delhi-110016
Name of the Holding Company of the SPV	Company Secretary, PFC Consulting Limited First Floor, "Urjanidhi", 1 Barakhamba Lane, Connaught Place, New Delhi- 110001
Company (Before Closing Date)	Project In-charge Khavda PS1 and 3 Transmission Limited First Floor, "Urjanidhi", 1 Barakhamba Lane, Connaught Place, New Delhi- 110001
Company (After Closing Date)	Khavda PS1 and 3 Transmission Limited B-9, Qutab Institutional Area, Katwaria Sarai, New Delhi-110016

- c) Any Party may by notice of at least fifteen (15) days to the other Parties change the address and / or addresses to which such notices and communications to it are to be delivered or mailed.

6.2 RESOLUTION OF DISPUTES

- 6.2.1 If any dispute arises between the Parties, in connection with the validity, interpretation, implementation or alleged breach of any provision of this Agreement ("Dispute"), the disputing Parties hereto shall endeavour to settle such

Sachin
Arora

Digitally signed
by Sachin Arora
Date:
2024.11.07
18:56:54
+05'30'

Neeraj
Singh

Digitally signed
by Neeraj Singh
Date:
2024.11.07
18:47:24 +05'30'

SATYAPRAK
ASH DASH

Digitally signed by
SATYAPRAKASH DASH
Date: 2024.11.07
19:38:26 +05'30'



Dispute amicably. The attempt to bring about an amicable settlement shall be considered to have failed if not resolved within 60 days from the date of the Dispute.

6.2.2 If the Parties are unable to amicably settle the Dispute in accordance with Clause 6.2.1 within the period specified therein, any of the Parties shall be entitled to within 30 days after expiry of the aforesaid period, refer the Dispute to the Company Secretary of PFCCL and Chief Executive/ Managing Director of the Selected Bidder for resolution of the said Dispute. The attempt to bring about such resolution shall be considered to have failed if not resolved within 30 days from the date of receipt of a written notification in this regard.

6.2.3 In the event the Dispute is not settled in accordance with Clause 6.2.2 above, any Party to the Dispute shall be entitled to serve a notice invoking this Clause and making a reference to a sole arbitrator. If the Parties to the Dispute cannot agree as to the appointment of the sole arbitrator within 30 days of receipt of the notice of the Party making the reference, then the Shares Seller along with the Company shall appoint one arbitrator and the Selected Bidder shall appoint one arbitrator and the two arbitrators, so appointed shall appoint a third arbitrator. However, after the Closing Date, in such an event the Shares Seller shall appoint one arbitrator and the Selected Bidder along with the Company shall appoint one arbitrator and the two arbitrators, so appointed shall appoint the third arbitrator.

6.2.4 The place of the arbitration shall be New Delhi. The Arbitration proceedings shall be governed by the Arbitration and Conciliation Act, 1996.

6.2.5 The proceedings of arbitration shall be in English language.

6.2.6 The arbitrator's award shall be substantiated in writing. The arbitrators shall also decide on the costs of the arbitration proceedings. In case the arbitrators have not decided on the costs of the arbitration proceedings, each Party to the Dispute shall bear its own costs, in relation to the arbitration proceedings.

6.3 AUTHORISED PERSON

For the purposes of this Agreement, the Selected Bidder is represented by **Shri Satyaprakash Dash, Company Secretary**, pursuant to an authorization granted to Shri Satyaprakash Dash, Company Secretary through necessary Board resolutions. Further, Shri Satyaprakash Dash, Company Secretary is also authorized by such resolutions to take any decision, which may be required to be taken, do all acts and execute all documents, which are or may be required by the Selected Bidder for the proper and effective fulfillment of the

Sachin
Arora

Digitally signed
by Sachin Arora
Date: 2024.11.07
18:57:22 +05'30'

PFCCL

Neeraj
Singh

Digitally signed
by Neeraj Singh
Date: 2024.11.07
18:47:39 +05'30'

KPS137L

SATYAPRAK
ASH DASH

Digitally signed by
SATYAPRAKASH DASH
Date: 2024.11.07
19:39:35 +05'30'

10
PGCIL

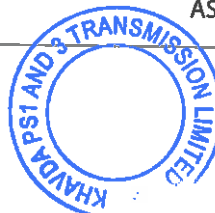

rights and obligations under this Agreement. Any action taken or document executed by Shri Satyaprakash Dash, Company Secretary, in case of Consortium] shall be deemed to be acts done or documents executed by the Selected Bidder and shall be binding on the Selected Bidder.

6.4 RESERVATION OF RIGHTS

No forbearance, indulgence or relaxation or inaction by any Party at any time to require performance of any of the provisions of this Agreement shall in any way affect, diminish or prejudice the right of such Party to require performance of that provision, and any waiver or acquiescence by any Party of any breach of any of the provisions of this Agreement shall not be construed as a waiver or acquiescence of any continuing or succeeding breach of such provisions, a waiver of any right under or arising out of this Agreement or acquiescence to or recognition of rights other than that expressly stipulated in this Agreement.

6.5 CUMULATIVE RIGHTS

All remedies of either Party under this Agreement whether provided herein or conferred by statute, civil law, common law, custom or trade usage, are cumulative and not alternative and may be enforced successively or concurrently.

6.6 PARTIAL INVALIDITY

If any provision of this Agreement or the application thereof to any person or circumstance shall be invalid or unenforceable to any extent, the remainder of this Agreement and the application of such provision to persons or circumstances other than those as to which it is held invalid or unenforceable shall not be affected thereby, and each provision of this Agreement shall be valid and enforceable to the fullest extent permitted by law. Any invalid or unenforceable provision of this Agreement shall be replaced with a provision, which is valid and enforceable and most nearly reflects the original intent of the unenforceable provision.

6.7 TERMINATION

If (i) the Closing does not occur on the Closing Date for any reason whatsoever, or (ii) the Letter of Intent is withdrawn or terminated for any reason, or (iii) due to termination of the TSA by Central Transmission Utility of India Limited in accordance with Article 3.3.2 or Article 13 of the TSA thereof, PFCCCL shall have a right to terminate this Agreement forthwith by giving a written notice to the other Parties hereto.

Sachin
Arora

Digitally signed
by Sachin Arora
Date: 2024.11.07
18:57:50 +05'30'

Neeraj
Singh

Digitally signed
by Neeraj Singh
Date: 2024.11.07
18:47:55 +05'30'

SATYAPRAK
ASH DASH

Digitally signed by
SATYAPRAKASH DASH
Date: 2024.11.07
19:40:54 +05'30'

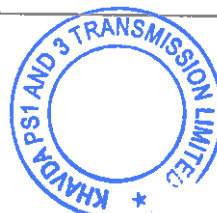

6.8 AMENDMENTS

No modification or amendment of this Agreement and no waiver of any of the terms or conditions hereof shall be valid or binding unless made in writing and duly executed by all the Parties.

6.9 ASSIGNMENT

This Agreement and the rights and liabilities hereunder shall bind and inure to the benefit of the respective successors of the Parties hereto, but no Party hereto shall assign or transfer its rights and liabilities hereunder to any other Person without the prior written consent of the other Parties, which will not be unreasonably withheld.

6.10 ENTIRE AGREEMENT

This Agreement constitutes the entire Agreement between the Parties with respect to the subject matter herein and supersedes and cancels any prior oral or written agreement, representation, understanding, arrangement, communication or expression of intent relating to the subject matter of this Agreement.

6.11 COSTS

Each of the Parties hereto shall pay their own costs and expenses relating to the negotiation, preparation and execution of this Agreement and the transactions contemplated by this Agreement.

The Selected Bidder shall be liable to bear and pay the stamp duty and other costs in respect of this Agreement and the Share Transfer Forms.

6.12 RELATIONSHIP

None of the provisions of this Agreement shall be deemed to constitute a partnership between the Parties hereto and no Party shall have any authority to bind the other Party otherwise than under this Agreement or shall be deemed to be the agent of the other in any way.

6.13 GOVERNING LAW AND JURISDICTION

This Agreement shall be governed by and construed in accordance with the laws of India and shall be subject to the exclusive jurisdiction of the courts of Delhi.

Sachin Arora
Digitally signed by Sachin Arora
Date: 2024.11.07
18:58:24 +05'30'

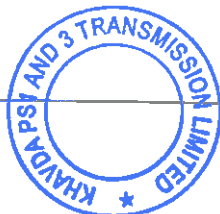

Neeraj Singh
Digitally signed by Neeraj Singh
Date: 2024.11.07
18:48:12 +05'30'

SATYAPRAKASH DASH
Digitally signed by SATYAPRAKASH DASH
Date: 2024.11.07
19:42:15 +05'30'

PFCCCL

KPS137L

PGCIL

6.14 COUNTERPARTS

This Agreement may be executed in counterparts by the Parties and each fully executed counterpart shall be deemed to be original.

6.15 CONFIDENTIALITY

The Parties undertake to hold in confidence and not to disclose the terms and conditions of the transaction contemplated hereby to third parties, except:

- (a) to their professional advisors;
- (b) to their officers, employees, agents or representatives, who need to have access to such information for the proper performance of their activities;
- (c) disclosures required under Law;

without the prior written consent of the other Parties.

Provided that Central Transmission Utility of India Limited and PFCCIL may at any time, disclose the terms and conditions of transactions contemplated hereby to any person, to the extent stipulated under the law or the Bidding Guidelines.

6.16 INDEMNIFICATION

- The Parties hereby agree that transfer of Sale Shares to the Selected Bidder shall vest all the rights, privileges, licenses, responsibilities, liabilities and other obligations pertaining to the Company in the Selected Bidder.
- The Selected Bidder hereby agrees that the Selected Bidder shall not be entitled to any claims or initiate any legal proceedings, by itself or through the Transmission Service Provider against the Share Sellers, its directors, officers, employees and the subscribers including the members of any committees appointed by them in respect of any actions or decisions taken by any of them up to the Closing Date in furtherance of the Project referred to in recital A of this Agreement.
- Further, the Selected Bidder hereby indemnifies and holds harmless at all times the Share Seller against all losses, damages, charges, and expenses which the Share Seller may sustain or incur towards contractual obligations with respect to the contracts awarded by the Share Seller or any other liability arising with regard to any action/activity undertaken by the Share Seller for and on behalf of the Company in furtherance of the Project referred to above or otherwise concerning the Company. All such actions shall be defended by the Selected Bidder either itself or through the TSP at its own cost.
- The Parties hereby agree that the provisions of this clause shall survive the termination of this Agreement.

Sachin Arora
Digitally signed by Sachin Arora
Date: 2024.11.07 18:58:51 +05'30'

Neeraj Singh
Digitally signed by Neeraj Singh
Date: 2024.11.07 18:46:58 +05'30'

SATYAPRAK ASH DASH
Digitally signed by SATYAPRAKASH DASH
Date: 2024.11.07 19:43:28 +05'30'

PFCCIL

KPS137L

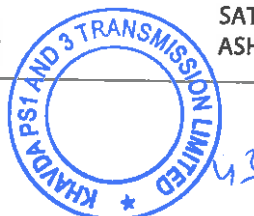

13

PGCIL

IN WITNESS WHEREOF, THE PARTIES HERETO HAVE CAUSED THIS AGREEMENT TO BE DULY EXECUTED AND DELIVERED AS OF THE DAY AND YEAR FIRST ABOVE WRITTEN

Sachin Arora
Digitally signed by Sachin Arora
Date: 2024.11.07
18:59:23 +05'30'

SIGNED AND DELIVERED

BY THE WITHIN NAMED "PFCCL" PFC Consulting Limited
BY THE HAND OF SHRI SACHIN ARORA, COMPANY SECRETARY

PURSUANT TO THE RESOLUTION PASSED BY THE BOARD OF DIRECTORS ON 23rd SEPTEMBER, 2024

Rakesh Mohan
Digitally signed by Rakesh Mohan
Date: 2024.11.07
19:02:07 +05'30'

IN THE PRESENCE OF:

WITNESS:

NAME, SIGNATURE, DESIGNATION AND ADDRESS:

Neeraj Singh
Digitally signed by Neeraj Singh
Date: 2024.11.07
18:48:55 +05'30'

SIGNED AND DELIVERED

BY THE WITHIN NAMED "KHAVDA PS1 AND 3 TRANSMISSION LIMITED"
BY THE HAND OF SHRI NEERAJ SINGH, CHAIRMAN

PURSUANT TO THE RESOLUTION PASSED BY THE BOARD OF DIRECTORS ON 19TH SEPTEMBER, 2024

Sachin Shukla
Digitally signed by Sachin Shukla
Date: 2024.11.07
19:03:43 +05'30'

IN THE PRESENCE OF:

WITNESS:

NAME, SIGNATURE, DESIGNATION AND ADDRESS:

SATYAPRAKASH DASH
Digitally signed by SATYAPRAKASH DASH
Date: 2024.11.07
19:45:07 +05'30'

SIGNED AND DELIVERED

BY THE WITHIN NAMED "POWER GRID CORPORATION OF INDIA LIMITED"

BY THE HAND OF SHRI SATYAPRAKASH DASH, COMPANY SECRETARY,

PURSUANT TO THE RESOLUTION PASSED BY THE BOARD OF DIRECTORS ON 7th NOVEMBER, 2023

Sachin Arora
Digitally signed by Sachin Arora
Date: 2024.11.07
18:59:55 +05'30'

PFCCL



Neeraj Singh
Digitally signed by Neeraj Singh
Date: 2024.11.07
18:49:16 +05'30'

KPS13TL

SATYAPRAKASH DASH
Digitally signed by SATYAPRAKASH DASH
Date: 2024.11.07
19:46:34 +05'30'

PGCIL

49

IN THE PRESENCE OF:

AMIT SHARMA
Digitally signed by AMIT SHARMA
Date: 2024.11.07 21:02:28 +05'30'

WITNESS:

NAME, SIGNATURE, DESIGNATION AND ADDRESS:



Sachin Arora
Digitally signed by Sachin Arora
Date: 2024.11.07 19:06:24 +05'30'

Neeraj Singh
Digitally signed by Neeraj Singh
Date: 2024.11.07 18:49:36 +05'30'

SATYAPRAKASH DASH
Digitally signed by SATYAPRAKASH DASH
Date: 2024.11.07 19:48:16 +05'30'

45

ANNEXURE A**DESCRIPTION OF THE SALE SHARES**

S. NO.	NAME OF THE SHAREHOLDER	NUMBER OF EQUITY SHARES HELD	PERCENTAGE OF THE TOTAL PAID UP EQUITY CAPITAL
1.	PFC Consulting Limited	9400	94 %
2.	Shri Manoj Kumar Rana	100	1 %
3.	Shri Neeraj Singh	100	1 %
4.	Shri Milind M. Dafade	100	1 %
5.	Shri Sanjay Kumar Nayak	100	1 %
6.	Shri Sachin Shukla	100	1 %
7.	Shri Rishab Jain	100	1 %
	Total	10,000	100%



Sachin Arora
Digitally signed by Sachin Arora
Date: 2024.11.07 19:00:57 +05'30'

Neeraj Singh
Digitally signed by Neeraj Singh
Date: 2024.11.07 18:50:04 +05'30'

SATYAPRAK ASH DASH
Digitally signed by SATYAPRAKASH DASH
Date: 2024.11.07 19:49:41 +05'30'

46

**TRANSMISSION SERVICE
AGREEMENT**

FOR

**DEVELOPMENT AND OPERATION OF INTER-
STATE TRANSMISSION SYSTEM**

**FOR TRANSMISSION OF ELECTRICITY THROUGH
TARIFF BASED COMPETITIVE BIDDING FOR**

**PROVISION OF DYNAMIC REACTIVE POWER
COMPENSATION AT KPS1 AND KPS3**

BETWEEN THE

**CENTRAL TRANSMISSION UTILITY OF INDIA
LIMITED (NODAL AGENCY)**

AND

**KHAVDA PS1 AND 3 TRANSMISSION
LIMITED**

November, 7th 2024

ATTESTED TRUE COPY

Attested from Pg 47-203A(24)



Transmission Service Agreement

CONTENTS

1.	DEFINITIONS AND INTERPRETATIONS	5
2.	EFFECTIVENESS AND TERM OF AGREEMENT	17
3.	CONDITIONS SUBSEQUENT	19
4.	DEVELOPMENT OF THE PROJECT	23
5.	CONSTRUCTION OF THE PROJECT	27
6.	CONNECTION AND COMMISSIONING OF THE PROJECT	31
7.	OPERATION AND MAINTENANCE OF THE PROJECT	36
8.	AVAILABILITY OF THE PROJECT	37
9.	INSURANCES	38
10.	BILLING AND PAYMENT OF TRANSMISSION CHARGES	40
11.	FORCE MAJEURE	41
12.	CHANGE IN LAW	45
13.	EVENTS OF DEFAULT AND TERMINATION	47
14.	LIABILITY AND INDEMNIFICATION	52
15.	ASSIGNMENTS AND CHARGES	57
16.	GOVERNING LAW AND DISPUTE RESOLUTION	59
17.	REPRESENTATION AND WARRANTIES	61
18.	INDEPENDENT ENGINEER	63
19.	MISCELLANEOUS PROVISIONS	65

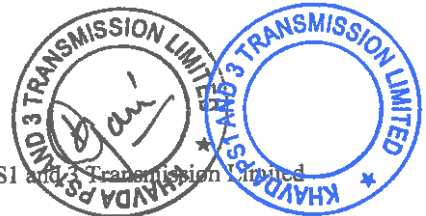

Bond



Indian-Non Judicial Stamp
Haryana Government



Date :01/10/2024

Certificate No. GOA2024J302

GRN No. 122060477



Stamp Duty Paid : ₹ 101
(Rs. Only)

Penalty : ₹ 0
(Rs Zero Only)

Deponent

Name: Central Transmission utility of India ltd

H.No/Floor : 2

Sector/Ward : 29

Landmark : Na

City/Village : Gurugram

District : Gurugram

State : Haryana

Phone : 98*****10



Purpose : ARTICLE 5 GENERAL AGREEMENT to be submitted at Concerned office

THIS TRANSMISISON SERVICE AGREEMENT (hereinafter referred to as "TSA" or "Agreement" or "the Agreement" or "this Agreement") is made on the ...7th... [Insert day] of...10th... [Insert month] of Two Thousand andTwenty Four.

BETWEEN:

The **Central Transmission Utility of India Limited**, having its registered address at "Saudamini",1st Floor, Plot No. 2, Sector-29, Gurugram-122001, Haryana and correspondence address at 5th to10th Floor, Ircon International Tower, Tower no- 1, Plot no -16 , Sector-32, Gurugram, Haryana-122003, acting as a Nodal Agency (referred to as the "Nodal Agency"), which expression shall unless repugnant to the context or meaning thereof include its successors, and permitted assigns) as Party of the one part;

AND

KHAVDA PS1 AND 3 TRANSMISSION LIMITED, incorporated under the Companies Act Companies Act, 2013, having its registered office at Urjanidhi, First Floor, Barakhamba Lane - 1, Connaught Place, Central Delhi, New Delhi, Delhi-110001 (herein after referred to as "Transmission Service Provider" or "TSP" or "ISTS Licensee", which expression shall unless repugnant to the context or meaning thereof include its successors, and permitted assigns) as Party of the other part;

("Nodal Agency" and "TSP" are individually referred to as "Party" and collectively as the "Parties")



Transmission Utility of India Limited 3



Khavda PS1 and 3 Transmission Limited

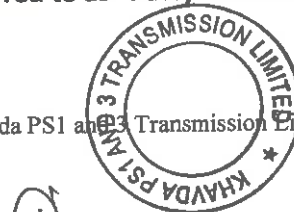



25

Transmission Service Agreement

AND WHEREAS:

- A) In accordance with the Bidding Guidelines, the Bid Process Coordinator (hereinafter referred to as BPC) had initiated a competitive e-reverse bidding process through issue of RFP for selecting a Successful Bidder to build, own, operate and transfer the Project comprising of the Elements mentioned in Schedule 1 (hereinafter referred to as the Project)
- B) Pursuant to the said e-reverse bidding process, the BPC has identified the Successful Bidder, who will be responsible to set up the Project on build, own, operate and transfer basis to provide Transmission Service in accordance with the terms of this Agreement and the Transmission License.
- C) The Selected Bidder have submitted the Contract Performance Guarantee and acquired one hundred percent (100%) of the equity shareholding of **KHAVDA PS1 AND 3 TRANSMISSION LIMITED**, along with all its related assets and liabilities in terms of the provisions of the Share Purchase Agreement.
- D) The TSP has agreed to make an application for a Transmission License to the Commission for setting up the Project on build, own, operate and transfer basis.
- E) The TSP has further agreed to make an application to the Commission for the adoption of the Transmission Charges under Section 63 of the Electricity Act, 2003, along with a certification from the Bid Evaluation Committee in accordance with the Bidding Guidelines issued by Ministry of Power, Government of India.
- F) The TSP has agreed to execute the agreement(s) required, if any, under Sharing Regulations within fifteen (15) days from the date of grant of Transmission License from the Commission.
- G) The TSP agrees to the terms and conditions laid down under Sharing Regulations, for making available the ISTS and charge the Transmission Charges in accordance with the terms and conditions of Sharing Regulations.
- H) The billing, collection and disbursement of the Transmission Charges by the CTU to the ISTS Licensee shall be governed as per Sharing Regulations.
- I) The terms and conditions stipulated in the Transmission License issued by the Commission to the TSP shall be applicable to this Agreement and the TSP agrees to comply with these terms and conditions. In case of inconsistency between the Transmission License terms & conditions and the conditions of this Agreement, the conditions stipulated in the Transmission License granted by the Commission shall prevail.

NOW, THEREFORE, IN CONSIDERATION OF THE PREMISES AND MUTUAL AGREEMENTS, COVENANTS AND CONDITIONS SET FORTH HEREIN, IT IS HEREBY AGREED BY AND BETWEEN THE PARTIES HERETO AS FOLLOWS:



Central Transmission Utility of India Limited



4

Khavda PS1 and 3 Transmission Limited

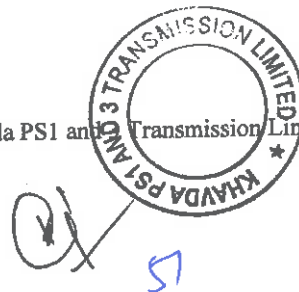

ARTICLE: 1

1. DEFINITIONS AND INTERPRETATIONS

1.1 Definitions:

1.1.1 The words / expressions used in this Agreement, unless as defined below or repugnant to the context, shall have the same meaning as assigned to them by the Electricity Act, 2003 and the rules or regulations framed there under including those issued / framed by the Commission (as defined hereunder), as amended or re-enacted from time to time or the General Clauses Act, failing which it shall bear its ordinary English meaning.

The words/expressions when used in this Agreement shall have the respective meanings as specified below:

"Acquisition Price" shall have the same meaning as defined in the Share Purchase Agreement;

"Act" or "Electricity Act" or "Electricity Act 2003" shall mean the Electricity Act, 2003 and any amendments made to the same or any succeeding enactment thereof;

"Affiliate" shall mean a company that either directly or indirectly

- i. controls or
- ii. is controlled by or
- iii. is under common control with

a Bidding Company (in the case of a single company) or a Member (in the case of a Consortium) and "control" means ownership by one entity of at least twenty six percent (26%) of the voting rights of the other entity;

"Availability" in relation to the Project or in relation to any Element of the Project, for a given period shall mean the time in hours during that period the Project is capable to transmit electricity at its Rated Voltage and shall be expressed in percentage of total hours in the given period and shall be calculated as per the procedure contained in **Appendix -IV to Central Electricity Regulatory Commission (Terms and Conditions of Tariff) Regulations, 2024**, attached herewith in Schedule 6;

"Bid" shall mean technical bid and financial bid submitted by the Bidder, in response to the RFP, in accordance with the terms and conditions of the RFP;

Central Transmission Utility of India Limited

5

Khavda PS1 and 3 Transmission Limited



Transmission Service Agreement

"Bid Deadline" shall mean the last date and time for submission of the Bid in response to RFP, as specified in the RFP;

"Bidding Company" shall refer to such single company that has made a Response to RFP for the Project;

"Bidding Consortium / Consortium" shall refer to a group of companies that has collectively made a Response to RFP for the Project;

"Bid Documents" or **"Bidding Documents"** shall mean the RFP, along with all attachments thereto or clarifications thereof;

"Bidding Guidelines" shall mean the "Tariff Based Competitive Bidding Guidelines for Transmission Service" and "Guidelines for Encouraging Competition in Development of Transmission Projects" issued by Government of India, Ministry of Power under Section –63 of the Electricity Act as amended from time to time;

"Bid Process Coordinator" or **"BPC"** shall mean a person or its authorized representative as notified by the Government of India, responsible for carrying out the process for selection of Bidder who will acquire Transmission Service Provider;

"Bill" shall mean any bill raised by the CTU on the DICs to recover the Transmission Charges pursuant to the Sharing Regulations;

"Business Day" shall mean a day other than Sunday or a statutory holiday, on which the banks remain open for business in the State in which the Nodal Agency's registered office is located and the concerned TSP are located;

"CEA" shall mean the Central Electricity Authority constituted under Section -70 of the Electricity Act;

"Change in law" shall have the meaning ascribed thereto in Article 12;

"Commercial Operation Date" or **"COD"** shall mean the date as per Article 6.2;

"Commission" or **"CERC"** shall mean the Central Electricity Regulatory Commission referred to in sub-section (1) of Section 76 of the Electricity Act, 2003 or its successors and assigns;

"Competent Court of Law" shall mean the Supreme Court or any High Court, or any tribunal or any similar judicial or quasi-judicial body in India that has jurisdiction to adjudicate upon issues relating to the Project;

"Connection Agreement" shall mean the agreement between the CTU or STU or any other concerned parties and the TSP, setting out the terms relating to the



Central Transmission Utility of India Limited



6

Khavda PS1 and 3 Transmission Limited

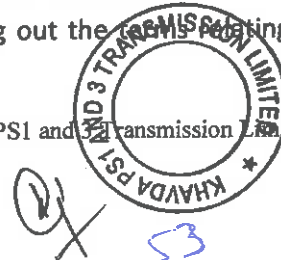

Transmission Service Agreement

connection of the Project to the Inter-connection Facilities and use of the Inter State Transmission System as per the provisions of the IEGC, as the case may be;

"Consultation Period" shall mean the period of sixty (60) days or such longer period as the Parties may agree, commencing from the date of issue of a TSP's Preliminary Notice or a Nodal Agency's Preliminary Termination Notice, as provided in Article 13 of this Agreement, for consultation between the Parties to mitigate the consequence of the relevant event having regard to all the circumstances;

"Consents, Clearances and Permits" shall mean all authorizations, licenses, approvals, registrations, permits, waivers, privileges, acknowledgements, agreements, or concessions required to be obtained from or provided by any concerned authority for the development, execution and operation of Project including without any limitation for the construction, ownership, operation and maintenance of the Transmission Lines and/or sub-stations;

"Construction Period" shall mean the period from (and including) the Effective Date of the Transmission Service Agreement up to (but not including) the COD of the Element of the Project in relation to an Element and up to (but not including) the COD of the Project in relation to the Project;

"Contractors" shall mean the engineering, procurement, construction, operation & maintenance contractors, surveyors, advisors, consultants, designers, suppliers to the TSP and each of their respective sub-contractors (and each of their respective successors and permitted assigns) in their respective capacities as such;

"Contract Performance Guarantee" shall mean the irrevocable unconditional bank guarantee, submitted and to be submitted by the TSP or by the Selected Bidder on behalf of the TSP to the Nodal Agency from a bank mentioned in Annexure 17 of the RFP, in the form attached here to as Schedule 8, in accordance with Article 3 of this Agreement and which shall include the additional bank guarantee furnished by the TSP under this Agreement;

"Contract Year", for the purpose of payment of Transmission Charges, shall mean the period beginning on the COD, and ending on the immediately succeeding March 31 and thereafter each period of 12 months beginning on April 1 and ending on March 31 provided that the last Contract Year shall end on the last day of the term of the TSA;

"CTU" or "Central Transmission Utility" shall have same meaning as defined in the Electricity Act, 2003;



Central Transmission Utility of India Limited

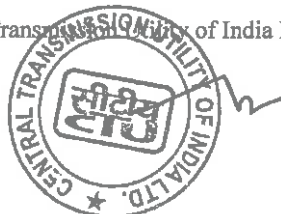

7

Khavda PSI and 3 Transmission Limited

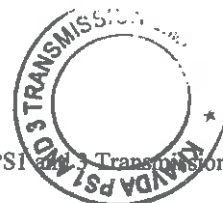

Handwritten signature and initials

Transmission Service Agreement

"Day" shall mean a day starting at 0000 hours and ending at 2400 hours;

"D/C" shall mean Double Circuit;

"Designated ISTS Customers" or **"DICs"** shall have the meaning as ascribed in the Sharing Regulations;

"Dispute" shall mean any dispute or difference of any kind between the Parties, in connection with or arising out of this Agreement including any issue on the interpretation and scope of the terms of this Agreement as provided in Article 16;

"Effective Date" for the purposes of this Agreement, shall have the same meaning as per Article 2.1 of this Agreement;

"Electrical Inspector" shall mean a person appointed as such by the Government under sub-section (1) of Section 162 of the Electricity Act 2003 and also includes Chief Electrical Inspector;

"Electricity Rules 2005" shall mean the rules framed pursuant to the Electricity Act 2003 and as amended from time to time;

"Element" shall mean each Transmission Line or each circuit of the Transmission Lines (where there are more than one circuit) or each bay of Sub-station or switching station or HVDC terminal or inverter station of the Project, including ICTs, Reactors, SVC, FSC, etc. forming part of the ISTS, which will be owned, operated and maintained by the concerned ISTS Licensee, and which has a separate Scheduled COD as per Schedule 2 of this Agreement and has a separate percentage for recovery of Transmission Charges on achieving COD as per Schedule 5 of this Agreement;

"Event of Default" shall mean the events as defined in Article 13 of this Agreement;

"Expiry Date" shall be the date which is thirty five (35) years from the COD of the Project;

"Financial Closure" shall mean the first Business Day on which funds are made available to the TSP pursuant to the Financing Agreements;

"Financially Evaluated Entity" shall mean the company which has been evaluated for the satisfaction of the financial requirement set forth in the RFP;

"Financing Agreements" shall mean the agreements pursuant to which the TSP is to finance the Project including the loan agreements, security documents, notes,

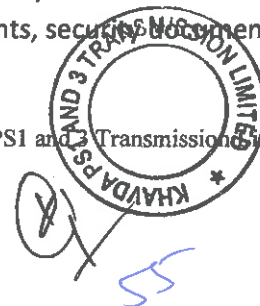
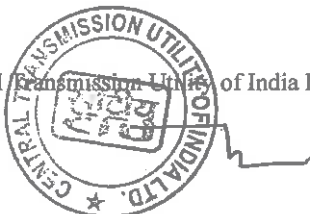

Transmission Service Agreement

indentures, security agreements, letters of credit and other documents, as may be amended, modified, or replaced from time to time, but without in anyway increasing the liabilities of the Designated ISTS Customers / Nodal Agency;

"Financial Year" shall mean a period of twelve months at midnight Indian Standard Time (IST) between 1st April & 31st March;

"Force Majeure" and **"Force Majeure Event"** shall have the meaning assigned thereto in Article 11;

"GOI" shall mean Government of India;

"Grid Code" / **"IEGC"** shall mean the Grid Code specified by the Central Commission under Clause (h) of sub-section (1) of Section 79 of the Electricity Act;

"Independent Engineer" shall mean an agency/ company, appointed by Nodal Agency in accordance with the Guidelines for Encouraging Competition in Development of Transmission Projects.

"Indian Governmental Instrumentality" shall mean Government of India, Government of any State in India or any ministry, department, board, authority, agency, corporation, commission under the direct or indirect control of Government of India or any State Government or both, any political sub-division of any of them including any court or Commission or tribunal or judicial or quasi-judicial body in India but excluding the CTU, TSP and the Designated ISTS Customers;

"Insurances" shall mean the insurance cover to be obtained and maintained by the TSP in accordance with Article 9 of this Agreement;

"Interconnection Facilities" shall mean the facilities as may be set up for transmission of electricity through the use of the Project, on either one or both side of generating station's / CTU's / STU's / ISTS Licensee's / Designated ISTS Customer's substations (as the case may be) which shall include, without limitation, all other transmission lines, gantries, sub-stations and associated equipment's not forming part of the Project;

"ISTS Licensee" shall be the TSP under this Agreement, consequent to having been awarded a Transmission License by the CERC and shall be referred to as the TSP or the ISTS Licensee, as the context may require in this Agreement;

"Law" or **"Laws"** in relation to this Agreement, shall mean all laws including electricity laws in force in India and any statute, ordinance, rule, regulation, notification, order or code, or any interpretation of any of them by an Indian



Transmission Service Agreement

Governmental Instrumentality having force of law and shall include all rules, regulations, decisions and orders of the Commission;

"Lead Member of the Bidding Consortium" or "Lead Member" shall mean a company who commits at least 26% equity stake in the Project, meets the technical requirement as specified in the RFP and so designated by other Member(s) in Bidding Consortium;

"Lenders" means the banks, financial institutions, multilateral funding agencies, non banking financial companies registered with the Reserve Bank of India (RBI), insurance companies registered with the Insurance Regulatory & Development Authority (IRDA), pension funds regulated by the Pension Fund Regulatory & Development Authority (PFRDA), mutual funds registered with Securities & Exchange Board of India (SEBI), etc., including their successors and assigns, who have agreed on or before COD of the Project to provide the TSP with the debt financing described in the capital structure schedule, and any successor banks or financial institutions to whom their interests under the Financing Agreements may be transferred or assigned;

Provided that, such assignment or transfer shall not relieve the TSP of its obligations to the Nodal Agency under this Agreement in any manner and shall also does not lead to an increase in the liability of the Nodal Agency;

"Lenders Representative" shall mean the person notified by the Lender(s) in writing as being the representative of the Lender(s) or the Security Trustee and such person may from time to time be replaced by the Lender(s) pursuant to the Financing Agreements by written notice to the TSP;

"Letter of Intent" or "LOI" shall have the same meaning as in the RFP;

"Member in a Bidding Consortium / Member" shall mean each company in the Bidding Consortium;

"Month" shall mean a period of thirty (30) days from (and excluding) the date of the event;

"Monthly Transmission Charges" for any Element of the Project, after COD of the Element till COD of the Project, and for the Project after COD of the Project, shall mean the amount of Transmission Charges as specified in Schedule 5 of this Agreement multiplied by no. of days in the relevant month and divided by no. of days in the year;

"National Load Despatch Centre" shall mean the centre established as per sub-section (1) of Section 26 of the Electricity Act 2003;



Central Transmission Utility of India Limited



10

Khavda PS1 and 3 Transmission Limited

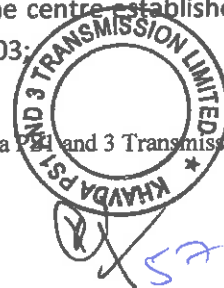

Transmission Service Agreement

“Nodal Agency” shall mean CTU, which shall execute and implement the Transmission Service Agreement (TSA);

Provided that while taking major decisions, CTU shall consult CEA on technical matters and any other matter it feels necessary.

“Notification” shall mean any notification, issued in the Gazette of India;

“Operating Period” for any Element of the Project shall mean the period from (and including) the COD of such Element of the Project, up to (and including) the Expiry Date and for the Project, shall mean the period from (and including) the COD of the Project, up to (and including) the Expiry Date;

“Parent Company” shall mean an entity that holds at least twenty six percent (26%) of the paid - up equity capital directly or indirectly in the Bidding Company or in the Member in a Bidding Consortium, as the case may be;

“Preliminary Termination Notice” shall mean a Nodal Agency’s Preliminary Termination Notice as defined in Article 13 of this Agreement;

“Project” shall mean “Provision of Dynamic Reactive Power Compensation at KPS1 and KPS3”, as detailed in Schedule 1 of this Agreement;

“Project Assets” shall mean all physical and other assets relating to and forming part of the Project including:

- (a) rights over the Site for substations, ROW for transmission lines;
- (b) tangible & intangible assets such as civil works and equipment including foundations, embankments, pavements, electrical systems, communication systems, relief centres, administrative offices, Sub-stations, software, tower and sub-stations designs etc;
- (c) project facilities situated on the Site;
- (d) all rights of the TSP under the project agreements;
- (e) financial assets, such as receivables, security deposits etc;
- (f) insurance proceeds; and
- (g) Applicable Permits and authorisations relating to or in respect of the Transmission System;”

“Project Execution Plan” shall mean the plan referred to in Article 3.1.3(c) hereof;

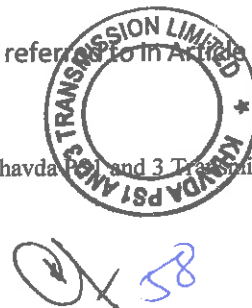

Transmission Service Agreement

"Prudent Utility Practices" shall mean the practices, methods and standards that are generally accepted internationally from time to time by electric transmission utilities for the purpose of ensuring the safe, efficient and economic design, construction, commissioning, operation, repair and maintenance of the Project and which practices, methods and standards shall be adjusted as necessary, to take account of:

- (i) operation, repair and maintenance guidelines given by the manufacturers to be incorporated in the Project,
- (ii) the requirements of Law, and
- (iii) the physical conditions at the Site;
- (iv) the safety of operating personnel and human beings;

"Rated Voltage" shall mean voltage at which the Transmission System is designed to operate or such lower voltage at which the line is charged, for the time being, in consultation with the Central Transmission Utility;

"Rebate" shall have the meaning as ascribed to in Article 10.3 of this Agreement;

"RFP" shall mean Request For Proposal dated **October 04, 2023** along with all schedules, annexures and RFP Project Documents attached thereto, issued by the BPC for tariff based competitive bidding process for selection of Bidder as TSP to execute the Project, including any modifications, amendments or alterations thereto;

"RFP Project Documents" shall mean the following documents to be entered into in respect of the Project, by the Parties to the respective agreements:

- a. Transmission Service Agreement,
- b. Share Purchase Agreement,
- c. Agreement(s) required under Sharing Regulations and
- d. Any other agreement as may be required;

"RLDC" shall mean the relevant Regional Load Dispatch Centre as defined in the Electricity Act, 2003, in the region(s) in which the Project is located;

"RPC" shall mean the relevant Regional Power Committee established by the Government of India for the specific Region(s) in accordance with the Electricity Act, 2003 for facilitating integrated operation of the Power System in that Region;

"Scheduled COD" in relation to an Element(s) shall mean the date(s) as mentioned

Central Transmission Utility of India Limited



Khavda P&T and 3 Transmission Limited



Transmission Service Agreement

in Schedule 2 as against such Element(s) and in relation to the Project, shall mean the date as mentioned in Schedule 2 as against such Project, subject to the provisions of Article 4.4 of this Agreement, or such date as may be mutually agreed among the Parties;

"Scheduled Outage" shall mean the final outage plan as approved by the RPC as per the provisions of the Grid Code;

"Selected Bid" shall mean the technical Bid and the Final Offer of the Selected Bidder submitted during e-reverse bidding, which shall be downloaded and attached in Schedule 7 on or prior to the Effective Date;

"Share Purchase Agreement" shall mean the agreement amongst **PFC Consulting Limited (PFCL)**, **KHAVDA PS1 AND 3 TRANSMISSION LIMITED** and the Successful Bidder for the purchase of one hundred (100%) per cent of the shareholding of the **KHAVDA PS1 AND 3 TRANSMISSION LIMITED** for the Acquisition Price, by the Successful Bidder on the terms and conditions as contained therein;

"Sharing Regulations" shall mean the Central Electricity Regulatory Commission (Sharing of Inter-State Transmission Charges and Losses) Regulations, 2020 and as amended from time to time;

"Site" in relation to a substation, switching station or HVDC terminal or inverter station, shall mean the land and other places upon which such station / terminal is to be established;

"SLDC" shall mean the State Load Despatch Centre established as per sub-section (1) of Section 31 of the Electricity Act 2003;

"STU" or **"State Transmission Utility"** shall be the Board or the Government company, specified as such by the State Government under sub-section (1) of Section 39 of the Electricity Act 2003;

"Successful Bidder" or **"Selected Bidder"** shall mean the Bidder selected pursuant to the RFP and who has to acquire one hundred percent (100%) equity shares of **KHAVDA PS1 AND 3 TRANSMISSION LIMITED**, along with all its related assets and liabilities, which will be responsible as the TSP to establish the Project on build, own, operate and transfer basis as per the terms of the TSA and other RFP Project Documents;

"TSP's Preliminary Notice" shall mean a notice issued by the TSP in pursuant to the provisions of Article 13.3 of this Agreement;

"Target Availability" shall have the meaning as ascribed hereto in Article 8.2 of

Central Transmission Utility of India Limited

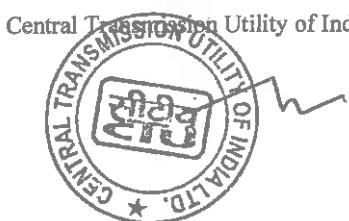

13



Khavda PS1 and 3 Transmission Limited

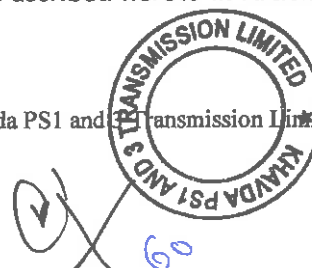

Transmission Service Agreement

this Agreement;

"Technically Evaluated Entity" shall mean the company which has been evaluated for the satisfaction of the technical requirement set forth in RFP;

"Termination Notice" shall mean a Nodal Agency's Termination Notice given by the Nodal Agency to the TSP pursuant to the provisions of Articles 3.3.2, 3.3.4, 4.4.2, 5.8, 13.2 and 13.3 of this Agreement for the termination of this Agreement;

"Term of Agreement" for the purposes of this Agreement shall have the meaning ascribed thereto in Article 2.2 of this Agreement;

"Transmission Charges" shall mean the Final Offer of the Selected Bidder during the e-reverse bidding and adopted by the Commission, payable to the TSP as per Sharing Regulations;

"Transmission License" shall mean the license granted by the Commission in terms of the relevant regulations for grant of such license issued under the Electricity Act;

"Transmission Service" shall mean making the Project available as per the terms and conditions of this Agreement and Sharing Regulations;

"Unscheduled Outage" shall mean an interruption resulting in reduction of the Availability of the Element(s) / Project (as the case may be) that is not a result of a Scheduled Outage or a Force Majeure Event.

"Ultimate Parent Company" shall mean an entity which owns at least twenty six percent (26%) equity in the Bidding Company or Member of a Consortium, (as the case may be) and in the Technically Evaluated Entity and / or Financially Evaluated Entity (as the case may be) and such Bidding Company or Member of a Consortium, (as the case may be) and the Technically Evaluated Entity and / or Financially Evaluated Entity (as the case may be) shall be under the direct control or indirectly under the common control of such entity;

1.2 Interpretation:

Save where the contrary is indicated, any reference in this Agreement to:

"Agreement" shall be construed as including a reference to its Schedules, Appendices and Annexures;

"Rupee", "Rupees" and "Rs." shall denote lawful currency of India;

"crore" shall mean a reference to ten million (10,000,000) and a **"lakh"** shall mean a reference to one tenth of a million (1,00,000);



Central Transmission Utility of India Limited

14

Khavda PS1 and 3 Transmission Limited

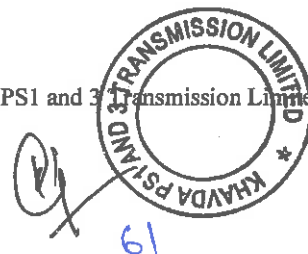

Transmission Service Agreement

"encumbrance" shall be construed as a reference to a mortgage, charge, pledge, lien or other encumbrance securing any obligation of any person or any other type of preferential arrangement (including, without limitation, title transfer and retention arrangements) having a similar effect;

"holding company" of a company or corporation shall be construed as a reference to any company or corporation of which the other company or corporation is a subsidiary;

"indebtedness" shall be construed so as to include any obligation (whether incurred as principal or surety) for the payment or repayment of money, whether present or future, actual or contingent;

"person" shall have the meaning as defined in Section 2 (49) of the Act;

"subsidiary" of a company or corporation (the holding company) shall be construed as a reference to any company or corporation:

- (i) which is controlled, directly or indirectly, by the holding company, or
- (ii) more than half of the issued share capital of which is beneficially owned, directly or indirectly, by the holding company, or
- (iii) which is a subsidiary of another subsidiary of the holding company,

for these purposes, a company or corporation shall be treated as being controlled by another if that other company or corporation is able to direct its affairs and/or to control the composition of its board of directors or equivalent body;

"winding-up", "dissolution", "insolvency", or "reorganization" in the context of a company or corporation shall have the same meaning as defined in the Companies Act, 1956/ Companies Act, 2013 (as the case may be).

1.2.1 Words importing the singular shall include the plural and vice versa.

1.2.2 This Agreement itself or any other agreement or document shall be construed as a reference to this or to such other agreement or document as it may have been, or may from time to time be, amended, varied, novated, replaced or supplemented.

1.2.3 A Law shall be construed as a reference to such Law including its amendments or re-enactments from time to time.

1.2.4 A time of day shall, save as otherwise provided in any agreement or document be construed as a reference to Indian Standard Time.

1.2.5 Different parts of this Agreement are to be taken as mutually explanatory and



Central Transmission Utility of India Limited



15

Khavda PS1 and 3 Transmission Limited



Transmission Service Agreement

supplementary to each other and if there is any inconsistency between or among the parts of this Agreement, they shall be interpreted in a harmonious manner so as to give effect to each part.

- 1.2.6 The tables of contents and any headings or sub-headings in this Agreement have been inserted for ease of reference only and shall not affect the interpretation of this Agreement.
- 1.2.7 All interest payable under this Agreement shall accrue from day to day and be calculated on the basis of a year of three hundred and sixty five (365) days.
- 1.2.8 The words "hereof" or "herein", if and when used in this Agreement shall mean a reference to this Agreement.
- 1.2.9 The contents of Schedule 7 shall be referred to for ascertaining accuracy and correctness of the representations made by the Selected Bidder in Article 17.2.1 hereof.



Central Transmission Utility of India Limited

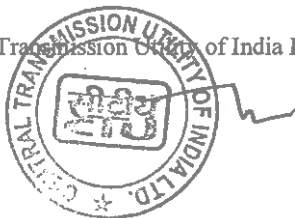

16

Khavda PS1 and 3 Transmission Limited



A handwritten signature in blue ink, consisting of stylized initials and a flourish.

ARTICLE: 2

2. EFFECTIVENESS AND TERM OF AGREEMENT

2.1 Effective Date:

This Agreement shall be effective from later of the dates of the following events:

- a. The Selected Bidder, on behalf of the TSP, has provided the Contract Performance Guarantee, as per terms of Article 3.1 of this Agreement; and
- b. The Selected Bidder has acquired for the Acquisition Price, one hundred percent (100%) of the equity shareholding of **PFC Consulting Limited** in **KHAVDA PS1 AND 3 TRANSMISSION LIMITED** along with all its related assets and liabilities as per the provisions of the Share Purchase Agreement. and
- c. The Agreement is executed and delivered by the Parties;

2.2 Term and Termination:

2.2.1 Subject to Article 2.2.3 and Article 2.4, this Agreement shall continue to be effective in relation to the Project until the Expiry Date, when it shall automatically terminate.

2.2.2 Post the Expiry Date of this Agreement, the TSP shall ensure transfer of Project Assets to CTU or its successors or an agency as decided by the Central Government at zero cost and free from any encumbrance and liability. The transfer shall be completed within 90 days of expiry of this Agreement failing which CTU shall be entitled to take over the Project Assets Suo moto.

2.2.3 This Agreement shall terminate before the Expiry Date in accordance with Article 13 or Article 3.3.2 or Article 3.3.4.

2.3 Conditions prior to the expiry of the Transmission License

In order to continue the Project beyond the expiry of the Transmission License, the TSP shall be obligated to make an application to the Commission at least two (2) years before the date of expiry of the Transmission License, seeking the Commission's approval for the extension of the term of the Transmission License up to the Expiry Date.

2.3.1 The TSP shall timely comply with all the requirements that may be laid down by the Commission for extension of the term of the Transmission License beyond the initial term of twenty-five (25) years & upto the Expiry Date and the TSP shall keep the Nodal Agency fully informed about the progress on its application for extension of the term of the Transmission License.

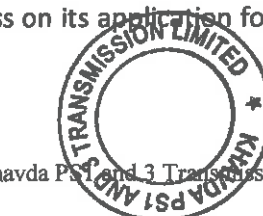

Transmission Service Agreement

2.4 Survival:

The expiry or termination of this Agreement shall not affect any accrued rights, obligations/ roles and liabilities of the Parties under this Agreement, including the right to receive liquidated damages as per the terms of this Agreement, nor shall it effect the survival of any continuing obligations/ roles for which this Agreement provides, either expressly or by necessary implication, which are to survive after the Expiry Date or termination including those under Articles 3.3.3, 3.3.5, Article 9.3 (Application of Insurance Proceeds), Article 11 (Force Majeure), Article 13 (Events of Default and Termination), Article 14 (Liability & Indemnification), Article 16 (Governing Law & Dispute Resolution), Article 19 (Miscellaneous).

2.5 Applicability of the provisions of this Agreement

2.5.1 For the purpose of Availability, Target Availability and the computation of Availability, Incentive, Penalty, the provisions provided in this Agreement shall apply and any future modifications in the relevant Rules and Regulations shall not be applicable for this Project.

2.5.2 For the purposes of this Agreement for ISTS systems developed under the tariff based competitive bidding framework, the provisions relating to the definitions (Availability and COD), Article 3 (Contract Performance Guarantee and Conditions Subsequent), Article 5 (Construction of the Project), Article 6 (Connection and Commissioning of the Project), Article 8 (Target Availability and calculation of Availability), Article 11 (Force Majeure), Article 12 (Change in Law), Article 13 (Event of Default), Article 14 (Indemnification), Article 15 (Assignment and Charges), Articles 0, 16.2 and 16.4 (Governing Laws and Dispute Resolution) and Article 17 (representation and warranties of the ISTS Licensee) of this agreement shall supersede the corresponding provisions under Sharing Regulations.



Central Transmission Utility of India Limited

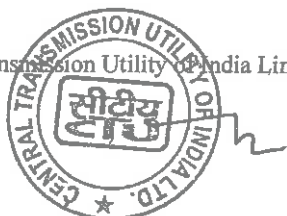

18

Khavda PS1 and 3 Transmission Limited

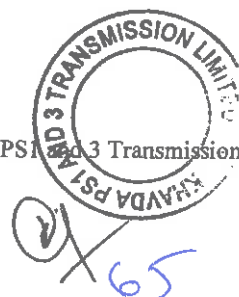

ARTICLE: 3

3. CONDITIONS SUBSEQUENT

3.1 Satisfaction of conditions subsequent by the TSP

3.1.1 Within ten (10) days from the date of issue of Letter of Intent, the Selected Bidder, shall:

- a. Provide the Contract Performance Guarantee, and
- b. Acquire, for the Acquisition Price, one hundred percent (100%) equity shareholding of **KHAVDA PS1 AND 3 TRANSMISSION LIMITED** from **PFC Consulting Limited**, who shall sell to the Selected Bidder, the equity shareholding of **KHAVDA PS1 AND 3 TRANSMISSION LIMITED** along with all its related assets and liabilities.
- c. Execute this Agreement;

The TSP shall, within five (5) working days from the date of acquisition of SPV by the Selected Bidder, undertake to apply to the Commission for the grant of Transmission License and for the adoption of tariff as required under section-63 of the Electricity Act.

The Selected Bidder, on behalf of the TSP, will provide to the **Central Transmission Utility of India Limited** (being the Nodal Agency) the Contract Performance Guarantee for an amount of **Rs. 24.75 Crore (Rupees Twenty Four Crore Seventy Five Lakh Only)**.

3.1.2 The Contract Performance Guarantee shall be initially valid for a period up to three (3) months after the Scheduled COD of the Project and shall be extended from time to time to be valid for a period up to three (3) months after the COD of the Project. In case the validity of the Contract Performance Guarantee is expiring before the validity specified in this Article, the TSP shall, at least thirty (30) days before the expiry of the Contract Performance Guarantee, replace the Contract Performance Guarantee with another Contract Performance Guarantee or extend the validity of the existing Contract Performance Guarantee until the validity period specified in this Article.

3.1.3 The TSP agrees and undertakes to duly perform and complete the following activities within six (6) months from the Effective Date (except for c) below), unless such completion is affected due to any Force Majeure Event, or if any of the activities is specifically waived in writing by the Nodal Agency:

- a. To obtain the Transmission License for the Project from the Commission;

Central Transmission Utility of India Limited

19

Khavda PS1 and 3 Transmission Limited

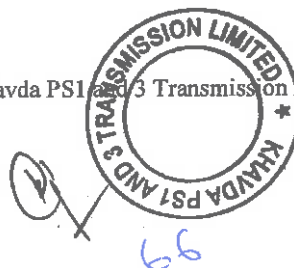
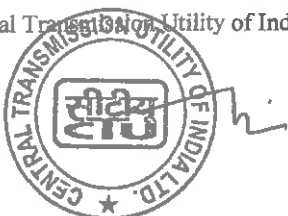

Transmission Service Agreement

- b. To obtain the order for adoption of Transmission Charges by the Commission, as required under Section 63 of the Electricity Act 2003;
- c. To submit to the Nodal Agency, CEA & Independent Engineer, the Project Execution Plan, immediately after award of contract(s) and maximum within one hundred and twenty (120) days from the Effective Date. Also, an approved copy each of Manufacturing Quality Plan (MQP) and Field Quality Plan (FQP) would be submitted to Independent Engineer & Nodal Agency in the same time period. The TSP's Project Execution Plan should be in conformity with the Scheduled COD as specified in Schedule 2 of this Agreement, and shall bring out clearly the organization structure, time plan and methodology for executing the Project, award of major contracts, designing, engineering, procurement, shipping, construction, testing and commissioning to commercial operation;
- d. To submit to the Nodal Agency, CEA & Independent Engineer a detailed bar (GANTT) chart of the Project outlining each activity (taking longer than one Month), linkages as well as durations;
- e. To submit to the Nodal Agency, CEA & Independent Engineer detailed specifications of conductor meeting the functional specifications specified in RFP;
- f. To achieve Financial Closure;
- g. To provide an irrevocable letter to the Lenders duly accepting and acknowledging the rights provided to the Lenders under the provisions of Article 15.3 of this Agreement and all other RFP Project Documents;
- h. To award the Engineering, Procurement and Construction contract ("EPC contract") for the design and construction of the Project and shall have given to such Contractor an irrevocable notice to proceed; and
- i. To sign the Agreement(s) required, if any, under Sharing Regulations.

3.2 Recognition of Lenders' Rights by the Nodal Agency

- 3.2.1 The Nodal Agency hereby accepts and acknowledges the rights provided to the Lenders as per Article 15.3 of this Agreement and all other RFP Project Documents.

3.3 Consequences of non-fulfilment of conditions subsequent

- 3.3.1 If any of the conditions specified in Article 3.1.3 is not duly fulfilled by the TSP even within three (3) Months after the time specified therein, then on and from the expiry of such period and until the TSP has satisfied the conditions

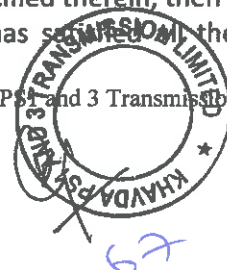
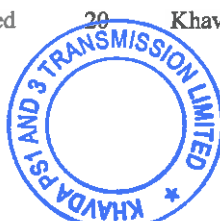

Transmission Service Agreement

specified in Article 3.1.3, the TSP shall, on a monthly basis, be liable to furnish to **Central Transmission Utility of India Limited (being the Nodal Agency)** additional Contract Performance Guarantee of **Rs 24.75 Crore (Rupees Twenty Four Crore Seventy Five Lakh Only)** within two (02) Business Days of expiry of every such Month. Such additional Contract Performance Guarantee shall be provided to **Central Transmission Utility of India Limited (being the Nodal Agency)** in the manner provided in Article 3.1.1 and shall become part of the Contract Performance Guarantee and all the provisions of this Agreement shall be construed accordingly. **Central Transmission Utility of India Limited (being the Nodal Agency)** shall be entitled to hold and / or invoke the Contract Performance Guarantee, including such additional Contract Performance Guarantee, in accordance with the provisions of this Agreement.

3.3.2 Subject to Article 3.3.4, if:

- (i) the fulfilment of any of the conditions specified in Article 3.1.3 is delayed beyond nine (9) Months from the Effective Date and the TSP fails to furnish additional Contract Performance Guarantee to the Nodal Agency in accordance with Article 3.3.1 hereof; or
- (ii) the TSP furnishes additional Performance Guarantee to the Nodal Agency in accordance with Article 3.3.1 hereof but fails to fulfil the conditions specified in Article 3.1.3 within a period of twelve (12) months from the Effective Date,

the Nodal Agency shall have the right to terminate this Agreement, by giving a Termination Notice to the TSP, in writing, of at least seven (7) days, with a copy to CEA and the Lenders' Representative in order to enable the Lenders to exercise right of substitution in accordance with Article 15.3 of this Agreement.

3.3.3 If the Nodal Agency elects to terminate this Agreement as per the provisions of Article 3.3.2, the TSP shall be liable to pay to the Nodal Agency an amount of **Rs. 24.75 Crore (Rupees Twenty Four Crore Seventy Five Lakh Only)** as liquidated damages. The Nodal Agency shall be entitled to recover this amount of damages by invoking the Contract Performance Guarantee to the extent of liquidated damages, which shall be required by the Nodal Agency, and the balance shall be returned to TSP, if any.

It is clarified for removal of doubt that this Article shall survive the termination of this Agreement.

3.3.4 In case of inability of the TSP to fulfil the conditions specified in Article 3.1.3 due to any Force Majeure Event, the time period for fulfilment of the condition subsequent as mentioned in Article 3.1.3, may be extended for a period of such Force Majeure Event. Alternatively, if deemed necessary, this Agreement may be terminated by the Nodal Agency by giving a Termination Notice to the TSP, in writing, of at least seven (7) days, with a copy to CEA and the Lenders' Representative in order to enable the Lenders to exercise right of substitution in accordance with Article 15.3 of this Agreement and the Contract Performance Guarantee shall be returned as per the

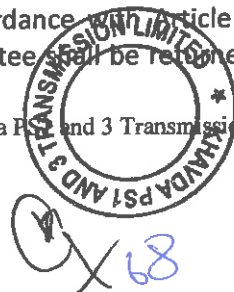
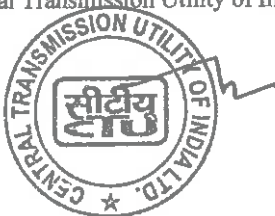

Transmission Service Agreement

provisions of Article 6.5.1.

Provided, that due to the provisions of this Article 3.3.4, any increase in the time period for completion of conditions subsequent mentioned under Article 3.1.3, shall lead to an equal increase in the time period for the Scheduled COD. If the Scheduled COD is extended beyond a period of one hundred eighty (180) days due to the provisions of this Article 3.3.4, the TSP will be allowed to recover the interest cost during construction corresponding to the period exceeding one hundred eighty (180) days by adjustment in the Transmission Charges in accordance with Schedule 9.

3.3.5 Upon termination of this Agreement as per Articles 3.3.2 and 3.3.4, the Nodal Agency may take steps to bid out the Project again.

3.3.6 The Nodal agency, on the failure of the TSP to fulfil its obligations, if it considers that there are sufficient grounds for so doing, apart from invoking the Contract Performance Guarantee under para 3.3.3 may also initiate proceedings for blacklisting the TSP as per provisions of Article 13.2 of TSA.

3.4 Progress Reports

The TSP shall notify the Nodal Agency and CEA in writing at least once a Month on the progress made in satisfying the conditions subsequent in Articles 3.1.3.

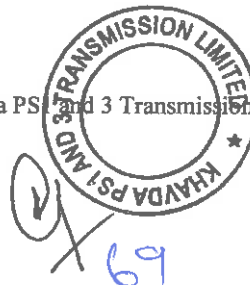

ARTICLE: 4

4. DEVELOPMENT OF THE PROJECT

4.1 TSP's obligations in development of the Project:

Subject to the terms and conditions of this Agreement, the TSP at its own cost and expense shall observe, comply with, perform, undertake and be responsible:

- a. for procuring and maintaining in full force and effect all Consents, Clearances and Permits, required in accordance with Law for development of the Project;
- b. for financing, constructing, owning and commissioning each of the Element of the Project for the scope of work set out in Schedule 1 of this Agreement in accordance with:
 - i. the Electricity Act and the Rules made thereof;
 - ii. the Grid Code;
 - iii. the CEA Regulations applicable, and as amended from time to time, for Transmission Lines and sub-stations:
 - the Central Electricity Authority (Technical Standards for Connectivity to the Grid) Regulations, 2007;
 - Central Electricity Authority (Technical Standards for construction of Electrical Plants and Electric Lines) Regulation, 2010;
 - Central Electricity Authority (Grid Standard) Regulations, 2010;
 - Central Electricity Authority (Safety requirements for construction, operation and maintenance of Electrical Plants and Electrical Lines) Regulation, 2011;
 - Central Electricity Authority (Measures relating to Safety and Electricity Supply) Regulation, 2010;
 - Central Electricity Authority (Technical Standards for Communication System in Power System Operation) Regulations, 2020.
 - iv. Safety/ security Guidelines laid down by the Government;
 - v. Prudent Utility Practices, relevant Indian Standards and the Law; not

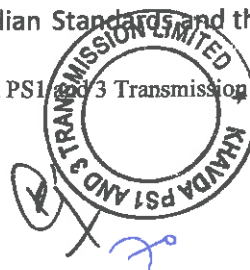

Transmission Service Agreement

later than the Scheduled COD as per Schedule 2 of this Agreement;

- c. for entering into a Connection Agreement with the concerned parties in accordance with the Grid Code.
- d. for owning the Project throughout the term of this Agreement free and clear of any encumbrances except those expressly permitted under Article 15 of this Agreement;
- e. to co-ordinate and liaise with concerned agencies and provide on a timely basis relevant information with regard to the specifications of the Project that may be required for interconnecting the Project with the Interconnection Facilities;
- f. for providing all assistance to the Arbitrators as they may require for the performance of their duties and responsibilities;
- g. to provide to the Nodal Agency and CEA, on a monthly basis, progress reports with regard to the Project and its execution (in accordance with prescribed form) to enable the CEA to monitor and co-ordinate the development of the Project matching with the Interconnection Facilities;
- h. to comply with Ministry of Power order no. 25-11/6/2018 – PG dated 02.07.2020 as well as other Guidelines issued by Govt. of India pertaining to this;
- i. to procure the products associated with the Transmission System as per provisions of Public Procurement (Preference to Make in India) orders issued by Ministry of Power vide orders No. 11/5/2018 - Coord. dated 28.07.2020 for transmission sector, as amended from time to time read with Department for Promotion of Industry and Internal Trade (DPIIT) orders in this regard (Procuring Entity as defined in above orders shall deemed to have included Selected Bidder and/ or TSP).

Also, to comply with Department of Expenditure, Ministry of Finance vide Order (Public Procurement No 1) bearing File No. 6/18/2019-PPD dated 23.07.2020, Order (Public Procurement No 2) bearing File No. 6/18/2019-PPD dated 23.07.2020 and Order (Public Procurement No. 3) bearing File No. 6/18/2019-PPD, dated 24.07.2020, as amended from time to time, regarding public procurement from a bidder of a country, which shares land border with India;

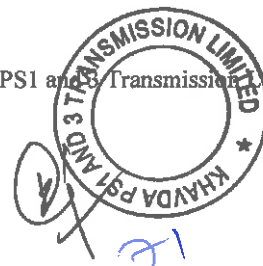

Transmission Service Agreement

- j. to submit to Nodal Agency information in the prescribed format [To be devised by Nodal Agency] for ensuring compliance to Article 4.1 i) above.
- k. to comply with all its obligations undertaken in this Agreement.

4.2 Roles of the Nodal Agency in implementation of the Project:

4.2.1 Subject to the terms and conditions of this Agreement, the Nodal Agency shall be the holder and administrator of this Agreement and shall inter alia:

- a. appoint an Independent Engineer within 90 days of the Effective Date
- b. provide letters of recommendation to the concerned Indian Governmental Instrumentality, as may be requested by the TSP from time to time, for obtaining the Consents, Clearances and Permits required for the Project;
- c. coordinate among TSP and upstream/downstream entities in respect of Interconnection Facilities; and
- d. monitor the implementation of the Agreement and take appropriate action for breach thereof including revocation of guarantees, cancellation of Agreement, blacklisting etc
- e. provide all assistance to the Arbitrators as required for the performance of their duties and responsibilities; and
- f. perform any other responsibility (ies) as specified in this Agreement.

4.3 Time for Commencement and Completion:

- a. The TSP shall take all necessary steps to commence work on the Project from the Effective Date of the Agreement and shall achieve Scheduled COD of the Project in accordance with the time schedule specified in Schedule 2 of this Agreement;
- b. The COD of each Element of the Project shall occur no later than the Scheduled COD or within such extended time to which the TSP shall be entitled under Article 4.4 hereto.

4.4 Extension of time:

4.4.1 In the event that the TSP is unable to perform its obligations for the reasons solely attributable to the Nodal Agency, the Scheduled COD shall be extended, by a 'day to day' basis, subject to the provisions of Article 13.

Central Transmission Utility of India Limited

Khavda PS1 and 3 Transmission Limited

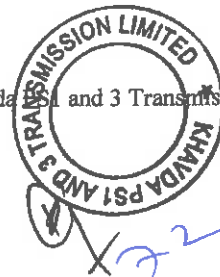
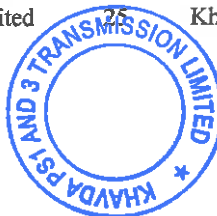
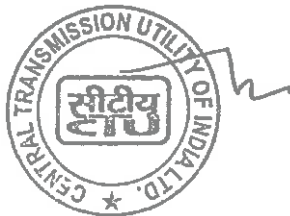

Transmission Service Agreement

4.4.2 In the event that an Element or the Project cannot be commissioned by its Scheduled COD on account of any Force Majeure Event as per Article 11, the Scheduled COD shall be extended, by a 'day to day' basis for a period of such Force Majeure Event. Alternatively, if deemed necessary, the Nodal Agency may terminate the Agreement as per the provisions of Article 13.4 by giving a Termination Notice to the TSP, in writing, of at least seven (7) days, with a copy to CEA and the Lenders' Representative in order to enable the Lenders to exercise right of substitution in accordance with Article 15.3 of this Agreement.

4.4.3 If the Parties have not agreed, within thirty (30) days after the affected Party's performance has ceased to be affected by the relevant circumstance, on how long the Scheduled COD should be deferred by, any Party may raise the Dispute to be resolved in accordance with Article 16.

4.5 Metering Arrangements:

4.5.1 The TSP shall comply with all the provisions of the IEGC and the Central Electricity Authority (Installation and Operation of Meters) Regulations, 2006 as amended from time to time, with regard to the metering arrangements for the Project. The TSP shall fully cooperate with the CTU / STU / RLDC and extend all necessary assistance in taking meter readings.

4.6 Interconnection Facilities:

4.6.1 Subject to the terms and conditions of this Agreement, the TSP shall be responsible for connecting the Project with the interconnection point(s) specified in Schedule 1 of this Agreement. The Interconnection Facilities shall be developed as per the scope of work and responsibilities assigned in Schedule 1 of this Agreement. The Nodal Agency shall be responsible for coordinating to make available the Interconnection Facilities.

4.6.2 In order to remove any doubts, it is made clear that the obligation of the TSP within the scope of the project is to construct the Project as per Schedule-1 of this Agreement and in particular to connect it to the Interconnection Facilities as specified in this Agreement.

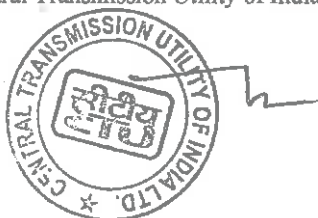

ARTICLE: 5

5. CONSTRUCTION OF THE PROJECT

5.1 TSP's Construction Responsibilities:

5.1.1 The TSP, at its own cost and expense, shall be responsible for designing, constructing, erecting, testing and commissioning each Element of the Project by the Scheduled COD in accordance with the Regulations and other applicable Laws specified in Article 4.1 of this Agreement.

5.1.2 The TSP acknowledges and agrees that it shall not be relieved from any of its obligations under this Agreement or be entitled to any extension of time or any compensation whatsoever by reason of the unsuitability of the Site or Transmission Line route(s).

5.1.3 The TSP shall be responsible for obtaining all Consents, Clearances and Permits related but not limited to road / rail / river / canal / power line / crossings, Power and Telecom Coordination Committee (PTCC), defence, civil aviation, right of way / way-leaves and environmental & forest clearances from relevant authorities required for developing, financing, constructing, maintaining/ renewing all such Consents, Clearances and Permits in order to carry out its obligations under this Agreement in general and shall furnish to the Nodal Agency such copy/ies of each Consents, Clearances and Permits, on demand. Nodal Agency shall provide letters of recommendation to the concerned Indian Governmental Instrumentality, as may be requested by the TSP from time to time, for obtaining the Consents, Clearances and Permits required for the Project.

5.1.4 The TSP shall be responsible for:

a) acquisition of land for location specific substations, switching stations or HVDC terminal or inverter stations. Also, the actual location of Greenfield substations (Switching Stations or HVDC Terminal or Inverter Stations) for a generation pooling substation and for load serving substations in the scope of TSP shall not be beyond 3 Km radius of the location proposed by the BPC in the survey report. However, actual location of any Greenfield intermediate Substations in the scope of TSP shall not be beyond 10 Km radius of the location proposed by the BPC in the Survey Report.

b) final selection of Site including its geo-technical investigation

c) Survey and geo-technical investigation of line route in order to determine the final route of the Transmission Lines;

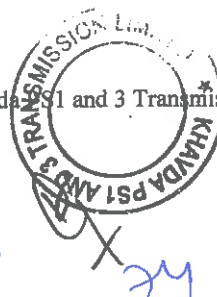
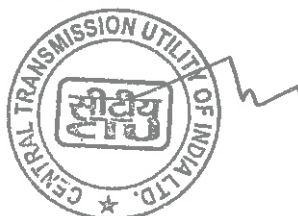

Transmission Service Agreement

d) Seeking access to the Site and other places where the Project is being executed, at its own risk and costs, including payment of any crop, tree compensation or any other compensation as may be required.

5.1.5 In case the Project involves any resettlement and rehabilitation, the resettlement and rehabilitation package will be implemented by the State Government authorities, for which the costs is to be borne by the TSP and no changes would be allowed in the Transmission Charges on account of any variation in the resettlement and rehabilitation cost. The TSP shall provide assistance on best endeavour basis, in implementation of the resettlement and rehabilitation package, if execution of such package is in the interest of expeditious implementation of the Project and is beneficial to the Project affected persons.

5.2 Appointing Contractors:

5.2.1 The TSP shall conform to the requirements as provided in this Agreement while appointing Contractor(s) for procurement of goods & services.

5.2.2 The appointment of such Contractor(s) shall neither relieve the TSP of any of its obligations under this Agreement nor make the Nodal Agency liable for the performance of such Contractor(s).

5.3 Monthly Progress Reporting:

The TSP shall provide to the CEA, Nodal Agency & Independent Engineer, on a monthly basis, progress reports along with likely completion date of each Element with regard to the Project and its execution (in accordance with prescribed form). The Nodal Agency/ CEA shall monitor the development of the Project for its timely completion for improving and augmenting the electricity system as a part of its statutory responsibility.

5.4 Quality of Workmanship:

The TSP shall ensure that the Project is designed, built and completed in a good workmanship using sound engineering and construction practices, and using only materials and equipment that are new and manufactured as per the MQP and following approved FQP for erection, testing & commissioning and complying with Indian /International Standards such that, the useful life of the Project will be at least thirty five (35) years from the COD of the Project.

The TSP shall ensure that all major substation equipment / component (e.g. transformers, reactors, Circuit Breakers, Instrument Transformers (IT), Surge Arresters (SA), Protection relays, clamps & connectors etc.), equipment in terminal stations of HVDC installations including Thyristor/ IGBT valves, Converter Transformers, smoothing reactors, Transformer bushings and wall bushings, GIS bus

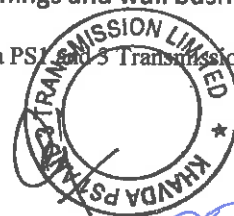

Transmission Service Agreement

ducts, towers and gantry structures and transmission towers or poles and line materials (conductors, earthwire, OPGW, insulator, accessories for conductors, OPGW & earthwires, hardware fittings for insulators, aviation lights etc), facilities and system shall be designed, constructed and tested (Type test, Routine tests, Factory Acceptance Test (FAT)) in accordance with relevant CEA Regulations and Indian Standards. In case Indian Standards for any particular equipment/ system/ process is not available, IEC/ IEEE or equivalent International Standards and Codes shall be followed.

5.5 Progress Monitoring & Quality Assurance:

- 5.5.1 The Project Execution Plan submitted by the TSP in accordance with Article 3.1.3 c) shall comprise of detailed schedule of all the equipments/items /materials required for the Project, right from procurement of raw material till the dispatch from works and receipt at the site. Further, it should also include various stages of the construction schedule up to the commissioning of the Project.
- 5.5.2 Nodal Agency, CEA & Independent Engineer shall have access at all reasonable times to the Site and to the Manufacturer's works and to all such places where the Project is being executed.
- 5.5.3 Independent Engineer shall ensure conformity of the conductor specifications with the functional specifications specified in RFP.
- 5.5.4 The Independent Engineer shall monitor the following during construction of the Project:
- Quality of equipments, material, foundation, structures and workmanship etc. as laid down in Article 5.4 and 6.1.4 of the TSA. Specifically, quality of Sub-station equipments, transmission line material and workmanship etc. would be checked in accordance with the Article 5.4.
 - Progress in the activities specified in Condition Subsequent
 - Verification of readiness of the elements including the statutory clearances & completion of civil works, fixing of all components and finalisation of punch points (if any) prior to charging of the elements
 - Progress of construction of substation and Transmission Lines
- 5.5.5 The progress shall be reviewed by the Independent Engineer against the Project Execution Plan. The Independent Engineer shall prepare its report on monthly basis and submit the same to Nodal Agency highlighting the progress achieved till the end

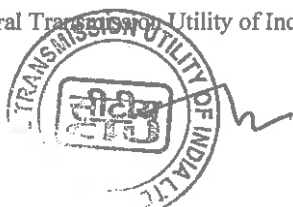

Handwritten signature and initials in blue ink.



Transmission Service Agreement

of respective month vis-à-vis milestone activities, areas of concern, if any, which may result in delay in the timely completion of the Project. Based on the progress, Nodal Agency and/ or CEA shall issue written instructions to the TSP to take corrective measures, as may be prudent for the timely completion of the Project. In case of any deficiency, the Nodal Agency would be at liberty to take action in accordance with the procedure of this Agreement.

- 5.5.6 For any delay in commissioning any critical Element(s), as identified in Schedule 1 & Schedule 2 of this Agreement, beyond a period of 45 days shall lead to a sequestration of 10% of the Contract Performance Guarantee.

5.6 Site regulations and Construction Documents

The TSP shall abide by the Safety Rules and Procedures as mentioned in Schedule 3 of this Agreement

The TSP shall retain at the Site and make available for inspection at all reasonable times, copies of the Consents, Clearances and Permits, construction drawings and other documents related to construction.

5.7 Supervision of work:

The TSP shall provide all necessary superintendence for execution of the Project and its supervisory personnel shall be available to provide full-time superintendence for execution of the Project. The TSP shall provide skilled personnel who are experienced in their respective fields.

5.8 Remedial Measures:

The TSP shall take all necessary actions for remedying the shortfall in achievement of timely progress in execution of the Project, if any, as intimated by the Independent Engineer and/ or CEA and/ or the Nodal Agency. However, such intimation by the Independent Engineer and/ or CEA and/ or the Nodal Agency and the subsequent effect of such remedial measures carried out by the TSP shall not relieve the TSP of its obligations in the Agreement. Independent Engineer and/ or CEA and/ or the Nodal Agency may carry out random inspections during the Project execution, as and when deemed necessary by it. If the shortfalls as intimated to the TSP are not remedied to the satisfaction of the CEA and/ or the Nodal Agency, this Agreement may be terminated by the Nodal Agency by giving a Termination Notice to the TSP, in writing, of at least seven (7) days, with a copy to CEA and the Lenders' Representative in order to enable the Lenders to exercise right of substitution in accordance with Article 15.3 of this Agreement.



Central Transmission Utility of India Limited



30

Khavda PST and 3 Transmission Limited



ARTICLE: 6

6. CONNECTION AND COMMISSIONING OF THE PROJECT

6.1 Connection with the Inter-Connection Facilities:

6.1.1 The TSP shall give the RLDC(s), CTU, / STU, as the case may be, and any other agencies as required, at least sixty (60) days advance written notice of the date on which it intends to connect an Element of the Project, which date shall not be earlier than its Scheduled COD or Schedule COD extended as per Article 4.4.1 & 4.4.2 of this Agreement, unless mutually agreed to by Parties. Further, any preponing of COD of any element prior to Scheduled COD must be approved by the Nodal Agency.

6.1.2 The RLDC / SLDC (as the case may be) or the CTU / STU (as the case may be), for reasonable cause, including non-availability of Interconnection Facilities as per Article 4.2, can defer the connection for up to fifteen (15) days from the date notified by the TSP pursuant to Article 6.1.1, if it notifies to the TSP in writing, before the date of connection, of the reason for the deferral and when the connection is to be rescheduled. However, no such deferment on one or more occasions would be for more than an aggregate period of thirty (30) days. Further, the Scheduled COD would be extended as required, for all such deferments on "day to day" basis.

6.1.3 Subject to Articles 6.1.1 and 6.1.2, any Element of Project may be connected with the Interconnection Facilities when:

- a. it has been completed in accordance with this Agreement and the Connection Agreement;
- b. it meets the Grid Code, Central Electricity Authority (Technical Standards for Connectivity to the Grid) Regulations, 2007 as amended from time to time and all other Indian legal requirements, and
- c. The TSP has obtained the approval in writing of the Electrical Inspector certifying that the Element is ready from the point of view of safety of supply and can be connected with the Interconnection Facilities.
- d. It has satisfactorily met all the testing requirements as per Articles 6.1.4.

6.1.4 Site Acceptance Test (SAT)/ pre-commissioning tests of all major substation equipment, component, system, facilities shall be successfully carried out before commissioning. The Type tests, FAT and SAT reports should be available at the substation / terminal station of HVDC installations for ready reference of operation and maintenance staff and has to be made available to the Independent Engineer

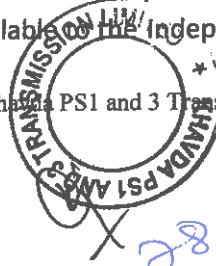

Transmission Service Agreement

appointed for quality monitoring or their authorised representatives, as and when they wish to examine the same.

6.2 Commercial Operation:

- 6.2.1 An Element of the Project shall be declared to have achieved COD twenty four (24) hours following the connection of the Element with the Interconnection Facilities pursuant to Article 6.1 or seven (7) days after the date on which it is declared by the TSP to be ready for charging but is not able to be charged for reasons not attributable to the TSP subject to Article 6.1.2.

Provided that an Element shall be declared to have achieved COD only after all the Element(s), if any, which are pre-required to have achieved COD as defined in Schedule 2 of this Agreement, have been declared to have achieved their respective COD.

- 6.2.2 Once any Element of the Project has been declared to have achieved deemed COD as per Article 6.2.1 above, such Element of the Project shall be deemed to have Availability equal to the Target Availability till the actual charging of the Element and to this extent, TSP shall be eligible for the Monthly Transmission Charges applicable for such Element.

6.3 Compensation for Direct Non Natural Force Majeure Event or Indirect Non Natural Force Majeure Event or Natural Force Majeure Event (affecting the Nodal Agency)

- 6.3.1 If the TSP is otherwise ready to connect the Element(s) of the Project and has given due notice, as per provisions of Article 6.1.1, to the concerned agencies of the date of intention to connect the Element(s) of the Project, where such date is not before the Scheduled COD, but is not able to connect the Element(s) of the Project by the said date specified in the notice, due to Direct Non Natural Force Majeure Event or Indirect Non Natural Force Majeure Event or Natural Force Majeure Event affecting the Nodal Agency, provided such Direct Non Natural Force Majeure Event or Indirect Non Natural Force Majeure Event or Natural Force Majeure Event affecting the Nodal Agency has continued for a period of more than three (3) continuous or non-continuous Months, the TSP shall, until the effects of the Direct Non Natural Force Majeure Event or of Indirect Non Natural Force Majeure Event or Natural Force Majeure Event affecting the Nodal Agency no longer prevent the TSP from connecting the Element(s) of the Project, be deemed to have achieved COD relevant to that date and to this extent, be deemed to have been providing Transmission Service with effect from the date notified, and shall be treated as follows:

- a. In case of delay due to Direct Non Natural Force Majeure Event, TSP is entitled for Transmission Charges calculated on Target Availability for the

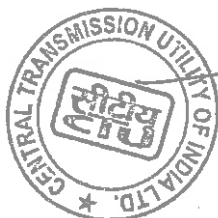

Transmission Service Agreement

period of such events in excess of three (3) continuous or non-continuous Months in the manner provided in (c) below.

- b. In case of delay due to Indirect Non Natural Force Majeure Event or Natural Force Majeure Event affecting the Nodal Agency, TSP is entitled for payment for debt service which is due under the Financing Agreements, subject to a maximum of Transmission Charges calculated on Target Availability, for the period of such events in excess of three (3) continuous or non continuous Months in the manner provided in (c) below.
- c. In case of delay due to Direct Non Natural Force Majeure Event or Indirect Non Natural Force Majeure Event or Natural Force Majeure Event affecting the Nodal Agency, the TSP is entitled for payments mentioned in (a) and (b) above, after commencement of Transmission Service, in the form of an increase in Transmission Charges. These amounts shall be paid from the date, being the later of a) the date of cessation of such Indirect Non Natural Force Majeure Event or Natural Force Majeure Event affecting the Nodal Agency and b) the completion of sixty (60) days from the receipt of the Financing Agreements by the Nodal Agency from the TSP.

Provided such increase in Transmission Charges shall be so as to put the TSP in the same economic position as the TSP would have been in case the TSP had been paid amounts mentioned in (a) and (b) above in a situation where the Force Majeure Event had not occurred.

For the avoidance of doubt, it is clarified that the charges payable under this Article 6.3.1 shall be recovered as per Sharing Regulations.

6.4 Liquidated Damages for Delay in achieving COD of Project:

- 6.4.1 If the TSP fails to achieve COD of any Element of the Project or the Project, by the Element's / Project's Scheduled COD or such Scheduled COD as extended under Articles 4.4.1 and 4.4.3, then the TSP shall pay to the Nodal Agency, a sum equivalent to 3.33% of Monthly Transmission Charges applicable for the Element of the Project [in case where no Elements have been defined, to be on the Project as a whole] / Project, for each day of delay up to sixty (60) days of delay and beyond that time limit, at the rate of five percent (5%) of the Monthly Transmission Charges applicable to such Element / Project, as liquidated damages for such delay and not as penalty, without prejudice to any rights of the Nodal Agency under the Agreement.
- 6.4.2 The TSP's maximum liability under this Article 6.4 shall be limited to the amount of liquidated damages calculated in accordance with Article 6.3.1 for and up to six (6)

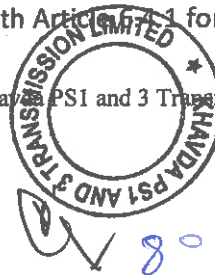

Transmission Service Agreement

months of delay for the Element or the Project.

Provided that, in case of failure of the TSP to achieve COD of the Element of the Project even after the expiry of six (6) months from its Scheduled COD, the provisions of Article 13 shall apply.

6.4.3 The TSP shall make payment to the Nodal Agency of the liquidated damages calculated pursuant to Article 6.4.1 within ten (10) days of the earlier of:

- a. the date on which the applicable Element achieves COD; or
- b. the date of termination of this Agreement.

The payment of such damages shall not relieve the TSP from its obligations to complete the Project or from any other obligation and liabilities under the Agreement.

6.4.4 If the TSP fails to pay the amount of liquidated damages to the Nodal Agency within the said period of ten (10) days, the Nodal Agency shall be entitled to recover the said amount of the liquidated damages by invoking the Contract Performance Guarantee. If the then existing Contract Performance Guarantee is for an amount which is less than the amount of the liquidated damages payable by the TSP to the Nodal Agency under this Article 6.3 and the TSP fails to make payment of the balance amount of the liquidated damages not covered by the Contract Performance Guarantee, then such balance amount shall be deducted from the Transmission Charges payable to the TSP. The right of the Nodal Agency to encash the Contract Performance Guarantee is without prejudice to the other rights of the Nodal Agency under this Agreement.

6.4.5 For avoidance of doubt, it is clarified that amount payable by TSP under this Article is over and above the penalty payable by TSP under Article 5.5.6 of this Agreement.

6.5 Return of Contract Performance Guarantee

6.5.1 The Contract Performance Guarantee as submitted by TSP in accordance with Article 3.1.1 shall be released by the Nodal Agency within three (3) months from the COD of the Project. In the event of delay in achieving Scheduled COD of any of the Elements by the TSP (otherwise than due to reasons as mentioned in Article 3.1.3 or Article 11) and consequent part invocation of the Contract Performance Guarantee by the Nodal Agency, Nodal Agency shall release the Contract Performance

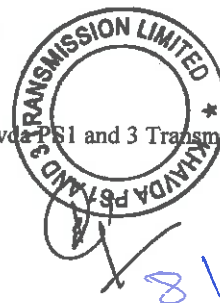
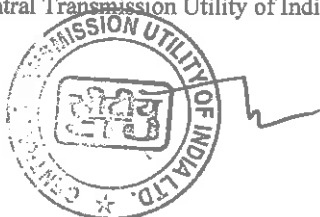

Transmission Service Agreement

Guarantee, if any remaining unadjusted, after the satisfactory completion by the TSP of all the requirements regarding achieving the Scheduled COD of the remaining Elements of the Project. It is clarified that the Nodal Agency shall also return / release the Contract Performance Guarantee in the event of (i) applicability of Article 3.3.2 to the extent the Contract Performance Guarantee is valid for an amount in excess of **Rs 24.75 Crore (Rupees Twenty Four Crore Seventy Five Lakh Only)**, or (ii) termination of this Agreement by the Nodal Agency as mentioned under Article 3.3.4 of this Agreement.

6.5.2 The release of the Contract Performance Guarantee shall be without prejudice to other rights of the Nodal Agency under this Agreement.

Central Transmission Utility of India Limited

35

Khavda PS1 and 3 Transmission Limited



Handwritten signature and the number 82.

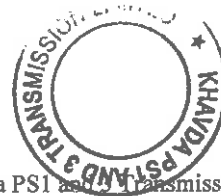

ARTICLE: 7

7. OPERATION AND MAINTENANCE OF THE PROJECT

7.1 Operation and Maintenance of the Project:

The TSP shall be responsible for ensuring that the Project is operated and maintained in accordance with the regulations made by the Commission and CEA from time to time and provisions of the Act.

Central Transmission Utility of India Limited

36

Khavda PS1 and 3 Transmission Limited

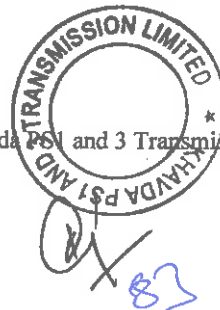

ARTICLE: 8

8. AVAILABILITY OF THE PROJECT

8.1 Calculation of Availability of the Project:

Calculation of Availability for the Elements and for the Project, as the case may be, shall be as per Appendix –IV to Central Electricity Regulatory Commission (Terms and Conditions of Tariff) Regulations, 2024, as applicable on the Bid Deadline and as appended in Schedule 6 of this Agreement.

8.2 Target Availability:

The Target Availability of each Element and the Project shall be **98%**.

Payment of monthly Transmission charges based on actual availability will be calculated as per para 1.2 of Schedule 4 of this Agreement.

If the availability of any Element or the Project is below the Target Availability, for six consecutive months in a Contract Year, the DIC(s) or the Nodal Agency may issue a show cause notice to the TSP, asking them to show cause as to why the Transmission Service Agreement be not terminated, and if no satisfactory cause is shown it may terminate the Agreement. If the Nodal Agency is of the opinion that the transmission system is of critical importance, it may carry out or cause to carry out the operation and maintenance of transmission system at the risk and cost of TSP.

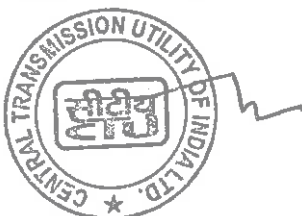
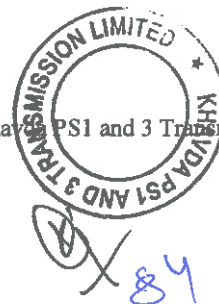

ARTICLE: 9

9. INSURANCES

9.1 Insurance:

9.1.1 The TSP shall effect and maintain or cause to be effected and maintained during the Construction Period and the Operating Period, adequate Insurances against such risks, with such deductibles including but not limited to any third party liability and endorsements and co-beneficiary/insured, as may be necessary under

- a. any of the Financing Agreements,
- b. the Laws, and
- c. in accordance with Prudent Utility Practices.

The Insurances shall be taken effective from a date prior to the date of the Financial Closure till the Expiry Date.

9.2 Evidence of Insurance cover:

9.2.1 The TSP shall furnish to the Nodal Agency copies of certificates and policies of the Insurances, as and when the Nodal Agency may seek from the TSP as per the terms of Article 9.1

9.3 Application of Insurance Proceeds:

9.3.1 Save as expressly provided in this Agreement, the policies of Insurances and the Financing Agreements, the proceeds of any insurance claim made due to loss or damage to the Project or any part of the Project shall be first applied to reinstatement, replacement or renewal of such loss or damage.

9.3.2 If a Natural Force Majeure Event renders the Project no longer economically and technically viable and the insurers under the Insurances make payment on a "total loss" or equivalent basis, the portion of the proceeds of such Insurance available to the TSP (after making admissible payments to the Lenders as per the Financing Agreements) shall be allocated only to the TSP. Nodal Agency and / or concerned Designated ISTS Customers shall have no claim on such proceeds of the Insurance.

9.3.3 Subject to the requirements of the Lenders under the Financing Agreements, any dispute or difference between the Parties as to whether the Project is no longer economically and technically viable due to a Force Majeure Event or whether that event was adequately covered in accordance with this Agreement by the Insurances shall be determined in accordance with Article 16.

Central Transmission Utility of India Limited

Khavda PS1 and 3 Transmission Limited

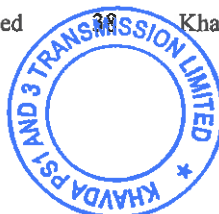

Transmission Service Agreement

9.4 Effect on liability of the Nodal Agency / Designated ISTS Customers

9.4.1 The Nodal Agency and / or the Designated ISTS Customers shall have no financial obligations or liability whatsoever towards the TSP in respect of this Article 9.

Central Transmission Utility of India Limited



39

Khavda PS1 and 3 Transmission Limited



85

ARTICLE: 10

10. BILLING AND PAYMENT OF TRANSMISSION CHARGES

10.1 Subject to provisions of this Article 10, the Monthly Transmission Charges shall be paid to the TSP, in Indian Rupees, on monthly basis as per the provisions of the Sharing Regulations, from the date on which an Element(s) has achieved COD until the Expiry Date of this Agreement, unless terminated earlier and in line with the provisions of Schedule 4 of this Agreement.

10.2 Calculation of Monthly Transmission Charges:

The Monthly Transmission Charges for each Contract Year including Incentive & Penalty payment shall be calculated in accordance with the provisions of Schedule 4 of this Agreement.

10.3 Rebate & Late Payment Surcharge:

The rebate and late payment surcharge shall be governed as per Sharing Regulations.

10.4 Disputed Bills, Default in payment by the Designated ISTS Customers & Annual Reconciliation:

Any Disputed Bill, Default in payment by the Designated ISTS Customers & Annual Reconciliation shall be governed as per Sharing Regulations.

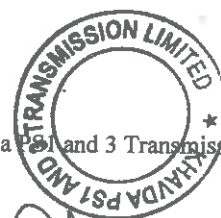
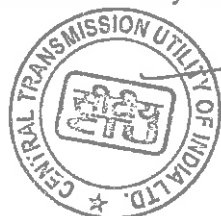

ARTICLE: 11

11. FORCE MAJEURE

11.1 Definitions

11.1.1 The following terms shall have the meanings given hereunder.

11.2 Affected Party

11.2.1 An Affected Party means any Party whose performance has been affected by an event of Force Majeure.

11.2.2 Any event of Force Majeure shall be deemed to be an event of Force Majeure affecting the TSP only if the Force Majeure event affects and results in, late delivery of machinery and equipment for the Project or construction, completion, commissioning of the Project by Scheduled COD and/or operation thereafter;

11.3 Force Majeure

A 'Force Majeure' means any event or circumstance or combination of events and circumstances including those stated below that wholly or partly prevents or unavoidably delays an Affected Party in the performance of its obligations/ roles under this Agreement, but only if and to the extent that such events or circumstances are not within the reasonable control, directly or indirectly, of the Affected Party and could not have been avoided if the Affected Party had taken reasonable care or complied with Prudent Utility Practices:

a) Natural Force Majeure Events:

- i. act of God, including, but not limited to drought, fire and explosion (to the extent originating from a source external to the Site), earthquake, volcanic eruption, landslide, flood, cyclone, typhoon, tornado, or exceptionally adverse weather conditions, which are in excess of the statistical measures for the last hundred (100) years; and
- ii. epidemic/ pandemic notified by Indian Governmental Instrumentality.

b) Non-Natural Force Majeure Events:

- i. Direct Non-Natural Force Majeure Events
 - Nationalization or compulsory acquisition by any Indian Governmental Instrumentality of any material assets or rights of the Affected Party; or

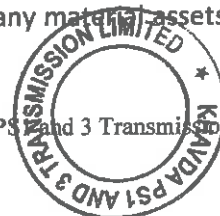
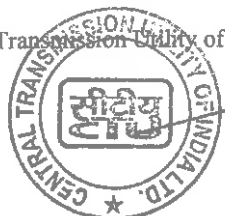

78

Transmission Service Agreement

- the unlawful, unreasonable or discriminatory revocation of, or refusal to renew, any Consents, Clearances and Permits required by the Affected Party to perform their obligations/ roles under the RFP Project Documents or any unlawful, unreasonable or discriminatory refusal to grant any other Consents, Clearances and Permits required for the development/ operation of the Project, provided that a Competent Court of Law declares the revocation or refusal to be unlawful, unreasonable and discriminatory and strikes the same down; or
- any other unlawful, unreasonable or discriminatory action on the part of an Indian Governmental Instrumentality which is directed against the Project, provided that a Competent Court of Law declares the action to be unlawful, unreasonable and discriminatory and strikes the same down.

ii. Indirect Non - Natural Force Majeure Events

- act of war (whether declared or undeclared), invasion, armed conflict or act of foreign enemy, blockade, embargo, revolution, riot, insurrection, terrorist or military action; or
- radio active contamination or ionising radiation originating from a source in India or resulting from any other Indirect Non Natural Force Majeure Event mentioned above, excluding circumstances where the source or cause of contamination or radiation is brought or has been brought into or near the Site by the Affected Party or those employed or engaged by the Affected Party; or
- industry-wide strikes and labour disturbances, having a nationwide impact in India.

11.4 Force Majeure Exclusions

11.4.1 Force Majeure shall not include (i) any event or circumstance which is within the reasonable control of the Parties and (ii) the following conditions, except to the extent that they are consequences of an event of Force Majeure:

- (a) Unavailability, late delivery, or changes in cost of the machinery, equipment, materials, spare parts etc. for the Project;
- (b) Delay in the performance of any Contractors or their agents;

Central Transmission Utility of India Limited

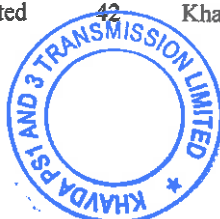

Khavda PS1 and 3 Transmission Limited

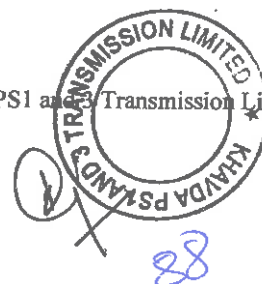

Transmission Service Agreement

- (c) Non-performance resulting from normal wear and tear typically experienced in transmission materials and equipment;
- (d) Strikes or labour disturbance at the facilities of the Affected Party;
- (e) Insufficiency of finances or funds or the Agreement becoming onerous to perform; and
- (f) Non-performance caused by, or connected with, the Affected Party's:
 - i. negligent or intentional acts, errors or omissions;
 - ii. failure to comply with an Indian Law; or
 - iii. breach of, or default under this Agreement or any Project Documents.
- (g) Any error or omission in the survey report provided by BPC during the bidding process.

11.5 Notification of Force Majeure Event

11.5.1 The Affected Party shall give notice to the other Party of any event of Force Majeure as soon as reasonably practicable, but not later than seven (7) days after the date on which such Party knew or should reasonably have known of the commencement of the event of Force Majeure. If an event of Force Majeure results in a breakdown of communications rendering it unreasonable to give notice within the applicable time limit specified herein, then the Party claiming Force Majeure shall give such notice as soon as reasonably practicable after reinstatement of communications, but not later than one (1) day after such reinstatement.

Provided that, such notice shall be a pre-condition to the Affected Party's entitlement to claim relief under this Agreement. Such notice shall include full particulars of the event of Force Majeure, its effects on the Party claiming relief and the remedial measures proposed. The Affected Party shall give the other Party regular reports on the progress of those remedial measures and such other information as the other Party may reasonably request about the Force Majeure.

11.5.2 The Affected Party shall give notice to the other Party of (i) the cessation of the relevant event of Force Majeure; and (ii) the cessation of the effects of such event of Force Majeure on the performance of its rights or obligations/ roles under this Agreement, as soon as practicable after becoming aware of each of these cessations.

11.6 Duty to perform and duty to mitigate

To the extent not prevented by a Force Majeure Event, the Affected Party shall continue to perform its obligations/ roles as provided in this Agreement. The

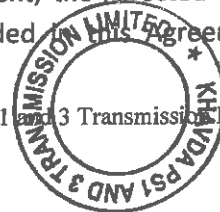
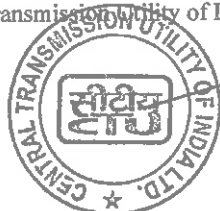

Transmission Service Agreement

Affected Party shall use its reasonable efforts to mitigate the effect of any event of Force Majeure as soon as practicable.

11.7 Available Relief for a Force Majeure Event

Subject to this Article 11,

- (a) no Party shall be in breach of its obligations/ roles pursuant to this Agreement to the extent that the performance of its obligations/ roles was prevented, hindered or delayed due to a Force Majeure Event;
- (b) each Party shall be entitled to claim relief for a Force Majeure Event affecting its performance in relation to its obligations/ roles under Articles 3.3.4, 4.4.2 and 6.3.1 of this Agreement.
- (c) For the avoidance of doubt, it is clarified that the computation of Availability of the Element(s) under outage due to Force Majeure Event, as per Article 11.3 affecting the TSP shall be as per Appendix –IV to Central Electricity Regulatory Commission (Terms and Conditions of Tariff) Regulations, 2024 as on Bid Deadline. For the event(s) for which the Element(s) is/are deemed to be available as per Appendix – IV to Central Electricity Regulatory Commission (Terms and Conditions of Tariff) Regulations, 2024, then the Transmission Charges, as applicable to such Element(s), shall be payable as per Schedule 4, for the duration of such event(s)
- (d) For so long as the TSP is claiming relief due to any Force Majeure Event under this Agreement, the Nodal Agency may, if it so desires, from time to time on one (1) day notice, inspect the Project and the TSP shall provide the Nodal Agency's personnel with access to the Project to carry out such inspections.
- (e) For avoidance of doubt, the TSP acknowledges that for extension of Scheduled COD a period up to one hundred eighty (180) days due to Force Majeure event, no compensation on the grounds such as interest cost, incident expenditure, opportunity cost will be made to the TSP. However, if Scheduled COD is extended beyond a period of one hundred eighty (180) days due to Force Majeure event, the TSP will be allowed to recover the interest cost during construction corresponding to the period exceeding one hundred eighty (180) days by adjustment in the Transmission Charges in accordance with Schedule 9.

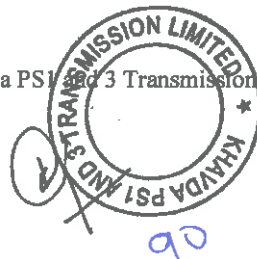

ARTICLE: 12

12. CHANGE IN LAW

12.1 Change in Law

12.1.1 Change in Law means the occurrence of any of the following after the Bid Deadline resulting into any additional recurring / non-recurring expenditure by the TSP or any savings of the TSP:

- the enactment, coming into effect, adoption, promulgation, amendment, modification or repeal (without re-enactment or consolidation) in India, of any Law, including rules and regulations framed pursuant to such Law, subject to the provisions under Article 12.1.2;
- a change in the interpretation or application of any Law by any Indian Governmental Instrumentality having the legal power to interpret or apply such Law, or any Competent Court of Law;
- the imposition of a requirement for obtaining any Consents, Clearances and Permits which was not required earlier;
- a change in the terms and conditions prescribed for obtaining any Consents, Clearances and Permits or the inclusion of any new terms or conditions for obtaining such Consents, Clearances and Permits;
- any change in the licensing regulations of the Commission, under which the Transmission License for the Project was granted if made applicable by such Commission to the TSP;
- change in wind zone; or
- any change in tax or introduction of any tax made applicable for providing Transmission Service by the TSP as per the terms of this Agreement.

12.1.2 Notwithstanding anything contained in this Agreement, Change in Law shall not cover any change:

- a) Taxes on corporate income; and
- b) Withholding tax on income or dividends distributed to the shareholders of the TSP.



Transmission Service Agreement

12.2 Relief for Change in Law

12.2.1 During Construction Period, the impact of increase/decrease in the cost of the Project on the Transmission Charges shall be governed by the formula given in Schedule 9 of this Agreement

12.2.2 During the Operation Period:

During the operation period, if as a result of Change in Law, the TSP suffers or is benefited from a change in costs or revenue, the aggregate financial effect of which exceeds 0.30% (zero point three percent) of the Annual Transmission Charges in aggregate for a Contract Year, the TSP may notify so to the Nodal Agency and propose amendments to this Agreement so as to place the TSP in the same financial position as it would have enjoyed had there been no such Change in Law resulting in change in costs or revenue as aforesaid.

12.2.3 For any claims made under Articles 12.2.1 and 12.2.2 above, the TSP shall provide to the Nodal Agency documentary proof of such increase / decrease in cost of the Project / revenue for establishing the impact of such Change in Law.

In cases where Change in Law results in decrease of cost and it comes to the notice of Nodal Agency that TSP has not informed Nodal Agency about such decrease in cost, Nodal Agency may initiate appropriate claim.

12.3 Notification of Change in Law:

12.3.1 If the TSP is affected by a Change in Law in accordance with Article 12.1 and wishes to claim relief for such Change in Law under this Article 12, it shall give notice to Nodal Agency of such Change in Law as soon as reasonably practicable after becoming aware of the same.

12.3.2 The TSP shall also be obliged to serve a notice to the Nodal Agency even when it is beneficially affected by a Change in Law.

12.3.3 Any notice served pursuant to Articles 12.3.1 and 12.3.2 shall provide, amongst other things, precise details of the Change in Law and its estimated impact on the TSP.

12.4 Payment on account of Change in Law

12.4.1 The payment for Change in Law shall be through a separate Bill. However, in case of any change in Monthly Transmission Charges by reason of Change in Law, as determined in accordance with this Agreement, the Bills to be raised by the Nodal Agency after such change in Transmission Charges shall appropriately reflect the changed Monthly Transmission Charges.

Central Transmission Utility of India Limited

46

Khavda PS and 3 Transmission Limited

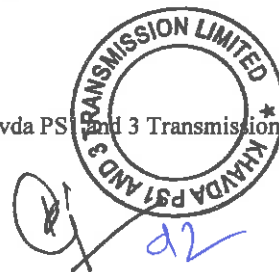
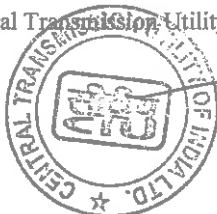

ARTICLE: 13

13. EVENTS OF DEFAULT AND TERMINATION

13.1 TSP's Event of Default

The occurrence and continuation of any of the following events shall constitute a TSP Event of Default, unless any such TSP Event of Default occurs as a result of any non-fulfilment of its obligations as prescribed under this Agreement by the Nodal Agency or a Force Majeure Event:

- a. After having taken up the construction of the Project, the abandonment by the TSP or the TSP's Contractors of the construction of the Project for a continuous period of two (2) months and such default is not rectified within thirty (30) days from the receipt of notice from the Nodal Agency in this regard;
- b. The failure to commission any Element of the Project by the date falling six (6) months after its Scheduled COD unless extended by Nodal Agency as per provisions of this Agreement;
- c. If the TSP:
 - i. assigns, mortgages or charges or purports to assign, mortgage or charge any of its assets or rights related to the Project in contravention of the provisions of this Agreement; or
 - ii. transfers or novates any of its obligations pursuant to this Agreement, in a manner contrary to the provisions of this Agreement;

Except where such transfer is in pursuance of a Law and

- it does not affect the ability of the transferee to perform, and such transferee has the financial and technical capability to perform, its obligations under this Agreement;
- is to a transferee who assumes such obligations under the Project and this Agreement remains effective with respect to the transferee;

- d. If:
 - i. The TSP becomes voluntarily or involuntarily the subject of any bankruptcy or insolvency or winding up proceedings and such

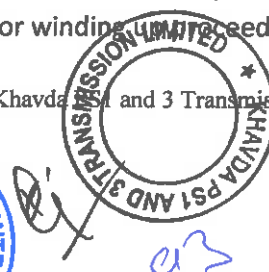

Transmission Service Agreement

proceedings remain uncontested for a period of thirty (30) days;
or

- ii. any winding up or bankruptcy or insolvency order is passed against the TSP; or
- iii. the TSP goes into liquidation or dissolution or a receiver or any similar officer is appointed over all or substantially all of its assets or official liquidator is appointed to manage its affairs, pursuant to Law,

Provided that a dissolution or liquidation of the TSP will not be a TSP's Event of Default, where such dissolution or liquidation of the TSP is for the purpose of a merger, consolidation or reorganization with the prior approval of the Commission as per the provisions of Central Electricity Regulatory Commission (Procedure, terms and Conditions for grant of Transmission License and other related matters) Regulations, 2006 or as amended from time to time; or

- e. Failure on the part of the TSP to comply with the provisions of Article 19.1 of this Agreement; or
- f. the TSP repudiates this Agreement and does not rectify such breach even within a period of thirty (30) days from a notice from the Nodal Agency in this regard; or
- g. after Commercial Operation Date of the Project, the TSP fails to achieve monthly Target Availability of 98% for a period of six (6) consecutive months or within a non-consecutive period of six (6) months within any continuous aggregate period of eighteen(18) months except where the Availability is affected by Force Majeure Events as per Article 11; or
- h. any of the representations and warranties made by the TSP in Article 17 of this Agreement being found to be untrue or inaccurate. Further, in addition to the above, any of the undertakings submitted by the Selected Bidder at the time of submission of the Bid being found to be breached or inaccurate, including but not limited to undertakings from its Parent Company / Affiliates related to the minimum equity obligation; or
- i. the TSP fails to complete / fulfil all the activities / conditions within the specified period as per Article 3; or



Transmission Service Agreement

- j. except for the reasons solely attributable to Nodal Agency, the TSP is in material breach of any of its obligations under this Agreement and such material breach is not rectified by the TSP within thirty (30) days of receipt of notice in this regard from the Nodal Agency; or
- k. the TSP fails to take the possession of the land required for location specific substations, switching stations or HVDC terminal or inverter stations and / or fails to pay the requisite price to the parties and / or any State Government authority from whom the land is acquired, within twelve (12) months from the Effective Date.

13.2 Termination Procedure for TSP Event of Default

- a. Upon the occurrence and continuance of any TSP's Event of Default under Article 13.1 the Nodal Agency may serve notice on the TSP, with a copy to the CEA and the Lenders' Representative, of their intention to terminate this Agreement (a "Nodal Agency's Preliminary Termination Notice"), which shall specify in reasonable detail, the circumstances giving rise to such Nodal Agency's Preliminary Termination Notice.
- b. Following the issue of a Nodal Agency's Preliminary Termination Notice, the Consultation Period shall apply and would be for the Parties to discuss as to what steps shall be taken with a view to mitigate the consequences of the relevant Event of Default having regard to all the circumstances.
- c. During the Consultation Period, the Parties shall, save as otherwise provided in this Agreement, continue to perform their respective obligations/ roles under this Agreement, and the TSP shall not remove any material, equipment or any part of the Project, without prior consent of the Nodal Agency.

Following the expiry of the Consultation Period, unless the Parties shall have otherwise agreed to the contrary or the circumstances giving rise to Nodal Agency's Preliminary Termination Notice shall have ceased to exist or shall have been remedied, this Agreement may be terminated by the Nodal Agency by giving a Termination Notice to the TSP, in writing, of at least seven (7) days, with a copy to CEA and the Lenders' Representative in order to enable the Lenders to exercise right of substitution in accordance with Article 15.3 of this Agreement.

Further, the Nodal Agency may also initiate proceedings to blacklist the TSP & its Affiliates from participation in any ~~project~~ issued by BPCs for a period of 5 years.

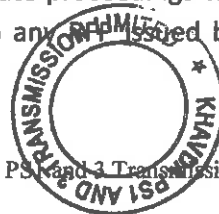
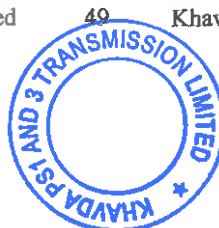

95

13.3 Procedure for Nodal Agency's non-fulfilment of Role

- a. Upon the Nodal Agency not being able to fulfil its role under Article 4.2, the TSP may serve notice on the Nodal Agency, with a copy to CEA and the Lenders' Representative (a "TSP's Preliminary Notice"), which notice shall specify in reasonable detail the circumstances giving rise to such non-fulfilment of role by the Nodal Agency.
- b. Following the issue of a TSP's Preliminary Notice, the Consultation Period shall apply.
- c. The Consultation Period would be for the Parties to discuss as to what steps shall be taken with a view to mitigate the consequences of the relevant non-fulfilment of role by the Nodal Agency including giving time extension to TSP, having regard to all the circumstances.
- d. During the Consultation Period, both Parties shall, save as otherwise provided in this Agreement, continue to perform their respective obligations/ roles under this Agreement.

13.4 Termination due to Force Majeure

13.4.1 In case the Parties could not reach an agreement pursuant to Articles 3.3.4 and 4.4.2 of this Agreement and the Force Majeure Event or its effects continue to be present, the Nodal Agency shall have the right to cause termination of the Agreement. In case of such termination, the Contract Performance Guarantee shall be returned to the TSP as per the provisions of Article 6.5.1.

13.4.2 In case of termination of this Agreement, the TSP shall provide to the Nodal Agency the full names and addresses of its Contractors as well as complete designs, design drawings, manufacturing drawings, material specifications and technical information, as required by the Nodal Agency within thirty (30) days of Termination Notice.

13.5 Termination or amendment due to non-requirement of any Element or Project during construction

13.5.1 In case any Element or Project, which is under construction, is no longer required due to any reason whatsoever, the Nodal Agency may issue a notice to this effect to the TSP.

13.5.2 Nodal agency may also issue notice to the TSP seeking their response to the proposed termination/ amendment (as the case may be) of the Agreement. The Nodal Agency shall issue copy of such notice to Lenders. In the notice, Nodal Agency



Transmission Service Agreement

shall also include an assessment of the physical progress made by TSP in the Element/ Project (as the case may be) that is no longer required.

13.5.3 The TSP shall neither carry out further investment nor carry out any work on the Element/ Project (as the case may be) that is no longer required after delivery of the notice.

13.5.4 After taking into account the comments of the TSP, the Nodal Agency may terminate the Agreement or amend it if both Parties agree to the amendment.

13.6 Revocation of the Transmission License

13.6.1 The Commission may, as per the provisions of the Electricity Act, 2003, revoke the Transmission License of the ISTS Licensee. Further, in such a case, the Agreement shall be deemed to have been terminated.

13.7 Termination Payment

13.7.1 If Agreement is terminated on account of Force Majeure Events, non-requirement of any Element or Project during Construction, Nodal Agency's non-fulfilment of Role & TSP's Event of Default, the TSP shall be entitled for Termination Payment equivalent to valuation of Project Assets. Upon payment, the Nodal Agency shall take over the Project Assets.

Central Transmission Utility of India Limited



51

Khavda PS and 3 Transmission Limited

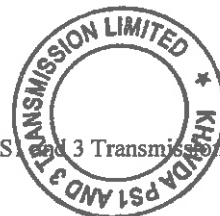
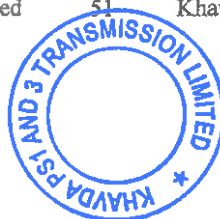

Handwritten signature and initials.

ARTICLE: 14

14. LIABILITY AND INDEMNIFICATION

14.1 Indemnity

14.1.1 The TSP shall indemnify, defend and hold the Nodal Agency harmless against:

- (a) any and all third party claims, actions, suits or proceedings against the Nodal Agency for any loss of or damage to property of such third party, or death or injury to such third party, arising out of a breach by the TSP of any of its obligations under this Agreement, except to the extent that any such claim, action, suit or proceeding has arisen due to a negligent act or omission, breach of this Agreement or non-fulfilment of statutory duty on the part of Nodal Agency; and
- (b) any and all losses, damages, costs and expenses including legal costs, fines, penalties and interest actually suffered or incurred by the Nodal Agency from third party claims arising by reason of:
 - i. a breach by the TSP of any of its obligations under this Agreement, (provided that this Article 14 shall not apply to such breaches by the TSP, for which specific remedies have been provided for under this Agreement) except to the extent that any such losses, damages, costs and expenses including legal costs, fines, penalties and interest (together to constitute "Indemnifiable Losses") has arisen due to a negligent act or omission, breach of this Agreement or non-fulfilment of statutory duty on the part of the Nodal Agency, or
 - ii. any of the representations and warranties of the TSP under this Agreement being found to be inaccurate or untrue.

14.1.2 The Nodal Agency shall, in accordance with the Regulations framed by CERC in this regard, indemnify, defend and hold the TSP harmless against:

- (a) any and all third party claims, actions, suits or proceedings against the TSP, for any loss of or damage to property of such third party, or death or injury to such third party, arising out of any material breach by the Nodal Agency of any of their roles under this Agreement, except to the extent that any such claim, action, suit or proceeding has arisen due to a negligent act or omission, breach of this Agreement or breach of statutory duty on the part of the TSP, its Contractors, servants or agents; and

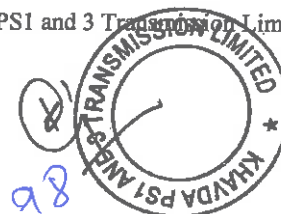
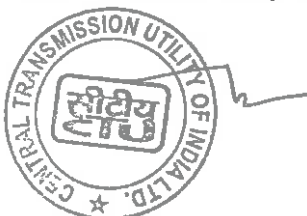

Transmission Service Agreement

(b) any and all losses, damages, costs and expenses including legal costs, fines, penalties and interest ('Indemnifiable Losses') actually suffered or incurred by the TSP from third party claims arising by reason of:

- i. any material breach by the Nodal Agency of any of its roles under this Agreement (provided that, this Article 14 shall not apply to such breaches by the Nodal Agency, for which specific remedies have been provided for under this Agreement), except to the extent that any such Indemnifiable Losses have arisen due to a negligent act or omission, breach of this Agreement or breach of statutory duty on the part of the TSP, its Contractors, servants or agents or
- ii. any of the representations and warranties of the Nodal Agency under this Agreement being found to be inaccurate or untrue.

14.2 Patent Indemnity:

14.2.1

- (a) The TSP shall, subject to the Nodal Agency's compliance with Article 14.2.1 (b), indemnify and hold harmless the Nodal Agency and its employees and officers from and against any and all suits, actions or administrative proceedings, claims, demands, losses, damages, costs, and expenses of whatsoever nature, including attorney's fees and expenses, which the Nodal Agency may suffer as a result of any infringement or alleged infringement of any patent, utility model, registered design, trademark, copyright or other intellectual property right registered or otherwise existing at the date of the Agreement by reason of the setting up of the Project by the TSP.

Such indemnity shall not cover any use of the Project or any part thereof other than for the purpose indicated by or to be reasonably inferred from the Agreement, any infringement resulting from the misuse of the Project or any part thereof, or any products produced in association or combination with any other equipment, plant or materials not supplied by the TSP, pursuant to the Agreement.

- (b) If any proceedings are brought or any claim is made against the Nodal Agency arising out of the matters referred to in Article 14.2.1(a), the Nodal Agency shall promptly give the TSP a notice thereof, and the TSP shall at its own expense take necessary steps and attend such proceedings or claim and any negotiations for the settlement of any such proceedings or claim. The TSP shall promptly notify the Nodal Agency of all actions taken in such

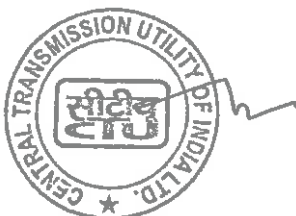

Transmission Service Agreement
proceedings or claims.

- (c) If the TSP fails to notify the Nodal Agency within twenty-eight (28) days after receipt of such notice from the Nodal Agency under Article 14.2.1(b) above, that it intends to attend any such proceedings or claim, then the Nodal Agency shall be free to attend the same on their own behalf at the cost of the TSP. Unless the TSP has so failed to notify the Nodal Agency within the twenty eight (28) days period, the Nodal Agency shall make no admission that may be prejudicial to the defence of any such proceedings or claims.
- (d) The Nodal Agency shall, at the TSP's request, afford all available assistance to the TSP in attending to such proceedings or claim, and shall be reimbursed by the TSP for all reasonable expenses incurred in so doing.

14.2.2

- (a) The Nodal Agency, in accordance with the Regulations framed by CERC in this regard, subject to the TSP's compliance with Article 14.2.2(b) shall indemnify and hold harmless the TSP and its employees, officers from and against any and all suits, actions or administrative proceedings, claims, demands, losses, damages, costs and expenses of whatsoever nature, including attorney's fees and expenses, which the TSP may suffer as a result of any infringement or alleged infringement of any patent, utility model, registered design, trademark, copyright or other intellectual property right registered or otherwise existing at the date of the Agreement by reason of the setting up of the Project by the TSP.
- (b) If any proceedings are brought or any claim is made against the TSP arising out of the matters referred to in Article 14.2.2 (a) the TSP shall promptly give the Nodal Agency a notice thereof, and the Nodal Agency shall at its own expense take necessary steps and attend such proceedings or claim and any negotiations for the settlement of any such proceedings or claim. The Nodal Agency shall promptly notify the TSP of all actions taken in such proceedings or claims.
- (c) If the Nodal Agency fails to notify the TSP within twenty-eight (28) days after receipt of such notice from the TSP under Article 14.2.2(b) above, that it intends to attend any such proceedings or claim, then the TSP shall be free to attend the same on its own behalf at the cost of the Nodal Agency. Unless the Nodal Agency has so failed to notify the TSP within the twenty (28) days period, the TSP shall make no admission that may be prejudicial to the defence of any such proceedings or claim.

Central Transmission Utility of India Limited

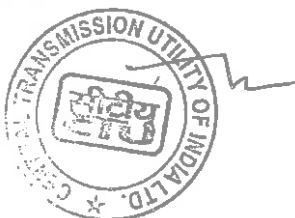

Khavda PS1 and 2 Transmission Limited

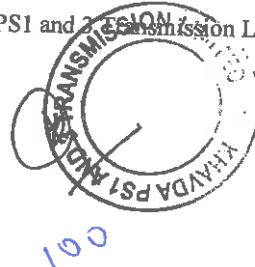

Transmission Service Agreement

- (d) The TSP shall, at the Nodal Agency request, afford all available assistance to the Nodal Agency in attending to such proceedings or claim, and shall be reimbursed by the Nodal Agency for all reasonable expenses incurred in so doing.

14.3 Monetary Limitation of liability

- 14.3.1 A Party ("Indemnifying Party") shall be liable to indemnify the other Party ("Indemnified Party") under this Article 14 for any indemnity claims made in a Contract Year only up to an amount of Rs. 1.65 Crore (Rupees One Crore Sixty Five Only).

14.4 Procedure for claiming indemnity

- 14.4.1 Where the Indemnified Party is entitled to indemnification from the Indemnifying Party pursuant to Articles 14.1 or 14.2 the Indemnified Party shall promptly notify the Indemnifying Party of such claim, proceeding, action or suit referred to in Articles 14.1 or 14.2 in respect of which it is entitled to be indemnified. Such notice shall be given as soon as reasonably practicable after the Indemnified Party becomes aware of such claim, proceeding, action or suit. The Indemnifying Party shall be liable to settle the indemnification claim within thirty (30) days of receipt of the above notice.

Provided however that, if:

- i. the Parties choose to contest, defend or litigate such claim, action, suit or proceedings in accordance with Article 14.4.3 below; and
- ii. the claim amount is not required to be paid/deposited to such third party pending the resolution of the Dispute,

the Indemnifying Party shall become liable to pay the claim amount to the Indemnified Party or to the third party, as the case may be, promptly following the resolution of the Dispute, if such Dispute is not settled in favour of the Indemnified Party.

- 14.4.2 The Indemnified Party may contest, defend and litigate a claim, action, suit or proceeding for which it is entitled to be indemnified under Articles 14.1 or 14.2 and the Indemnifying Party shall reimburse to the Indemnified Party all reasonable costs and expenses incurred by the Indemnified Party. However, such Indemnified Party shall not settle or compromise such claim, action, suit or proceedings without first getting the consent of the Indemnifying Party, which consent shall not be unreasonably withheld or delayed.

- 14.4.3 An Indemnifying Party may, at its own expense, assume control of the defence of any proceedings brought against the Indemnified Party if it acknowledges its obligation to indemnify such Indemnified Party, gives such Indemnified Party prompt notice of its intention to assume control of the defence, and employs an

Central Transmission Utility of India Limited

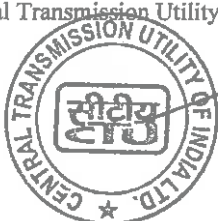

Khavda PS1 and 3 Transmission Limited

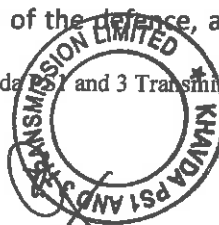

101

Transmission Service Agreement

independent legal counsel at its own cost that is reasonably satisfactory to the Indemnified Party.

14.5 Limitation on Liability

14.5.1 Except as expressly provided in this Agreement, neither the TSP nor the Nodal Agency nor their respective officers, directors, agents, employees or Affiliates (including, officers, directors, agents or employees of such Affiliates), shall be liable or responsible to the other Party or its Affiliates including its officers, directors, agents, employees, successors, insurers or permitted assigns for incidental, indirect or consequential, punitive or exemplary damages, connected with or resulting from performance or non-performance of this Agreement, or anything done in connection herewith, including claims in the nature of lost revenues, income or profits (other than payments expressly required and properly due under this Agreement), any increased expense of, reduction in or loss of transmission capacity or equipment used therefore, irrespective of whether such claims are based upon breach of warranty, tort (including negligence, whether of the Nodal Agency, the TSP or others), strict liability, contract, breach of statutory duty, operation of law or otherwise.

14.5.2 The Nodal Agency shall have no recourse against any officer, director or shareholder of the TSP or any Affiliate of the TSP or any of its officers, directors or shareholders for such claims excluded under this Article. The TSP shall also have no recourse against any officer, director or shareholder of the Nodal Agency, or any Affiliate of the Nodal Agency or any of its officers, directors or shareholders for such claims excluded under this Article.

14.6 Duty to Mitigate

The party entitled to the benefit of an indemnity under this Article 14 shall take all reasonable measures to mitigate any loss or damage which has occurred. If the Party fails to take such measures, the other Party's liabilities shall be correspondingly reduced.

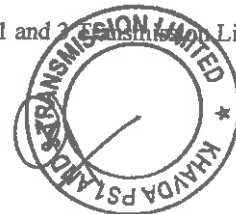
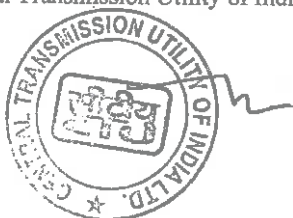

102

ARTICLE: 15

15. ASSIGNMENTS AND CHARGES

15.1 Assignments:

15.1.1 This Agreement shall be binding upon, and inure to the benefit of the Parties and their respective successors and permitted assigns. This Agreement shall not be assigned by any Party, except as provided in Article 15.3.

15.2 Permitted Charges:

15.2.1 Neither Party shall create or permit to subsist any encumbrance over all or any of its rights and benefits under this Agreement.

15.2.2 However, the TSP may create any encumbrance over all or part of the receivables, or the Project Assets of the Project in favour of the Lenders or the Lenders' Representative on their behalf, as security for amounts payable under the Financing Agreements and any other amounts agreed by the Parties.

Provided that:

- i. the Lenders or the Lenders' Representative on their behalf shall have entered into the Financing Agreements and agreed in writing to the provisions of this Agreement; and
- ii. any encumbrance granted by the TSP in accordance with this Article 15.2.2 shall contain provisions pursuant to which the Lenders or the Lender's Representative on their behalf agrees unconditionally with the TSP to release from such encumbrances upon payment by the TSP to the Lenders of all amounts due under the Financing Agreements.

15.2.3 Article 15.2.1 does not apply to:

- a. liens arising by operation of law (or by an agreement evidencing the same) in the ordinary course of the TSP developing and operating the Project;
- b. pledges of goods, the related documents of title and / or other related documents, arising or created in the ordinary course of the TSP developing and operating the Project; or
- c. security arising out of retention of title provisions in relation to goods acquired in the ordinary course of the TSP developing and operating the

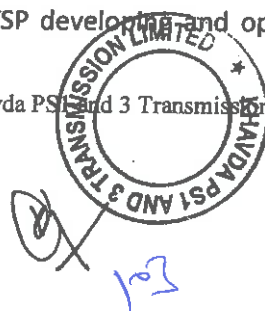

Transmission Service Agreement
Project.

15.3 Substitution Rights of the Lenders

15.3.1 The TSP would need to operate and maintain the Project under the provisions of this Agreement and cannot assign the Transmission License or transfer the Project or part thereof to any person by sale, lease, exchange or otherwise, without the prior approval of the Nodal Agency.

15.3.2 However, in the case of default by the TSP in debt repayments or in the case of default by the TSP as per Article 13 of this Agreement during the debt repayments, the Commission may, on an application from the Lenders, assign the Transmission License to the nominee of the Lenders subject to the fulfilment of the qualification requirements and provisions of the Central Electricity Regulatory Commission (Procedure, terms and Conditions for grant of Transmission License and other related matters) Regulations, 2006 and as amended from time to time.

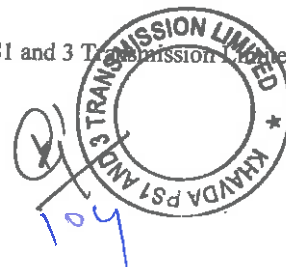
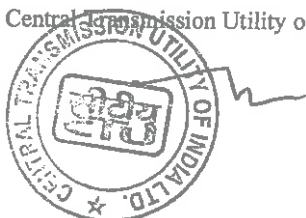

ARTICLE: 16

16. GOVERNING LAW AND DISPUTE RESOLUTION

16.1 Governing Law:

This Agreement shall be governed by and construed in accordance with the Laws of India. Any legal proceedings in respect of any matters, claims or disputes under this Agreement shall be under the jurisdiction of appropriate courts in Delhi.

16.2 Amicable Settlement:

16.2.1 Either Party is entitled to raise any claim, dispute or difference of whatever nature arising under, out of or in connection with this Agreement, including its existence or validity or termination or whether during the execution of the Project or after its completion and whether prior to or after the abandonment of the Project or termination or breach of the Agreement by giving a written notice to the other Party, which shall contain:

- (i) a description of the Dispute;
- (ii) the grounds for such Dispute; and
- (iii) all written material in support of its claim.

16.2.2 The other Party shall, within thirty (30) days of issue of notice issued under Article 16.2.1, furnish:

- (i) counter-claim and defences, if any, regarding the Dispute; and
- (ii) all written material in support of its defences and counter-claim.

16.2.3 Within thirty (30) days of issue of notice by the Party pursuant to Article 16.2.1, if the other Party does not furnish any counter claim or defense under Article 16.2.2, or thirty (30) days from the date of furnishing counter claims or defence by the other Party, both the Parties to the Dispute shall meet to settle such Dispute amicably. If the Parties fail to resolve the Dispute amicably within thirty (30) days from the later of the dates mentioned in this Article 16.2.3, the Dispute shall be referred for dispute resolution in accordance with Article 16.3.

16.3 Dispute Resolution:

All Disputes shall be adjudicated by the Commission.



Transmission Service Agreement

16.4 Parties to Perform Obligations:

Notwithstanding the existence of any Dispute and difference referred to the Commission as provided in Article 16.3 and save as the Commission may otherwise direct by a final or interim order, the Parties hereto shall continue to perform their respective obligations/ roles (which are not in dispute) under this Agreement.

Central Transmission Utility of India Limited

60

Khavda PS1 and 3 Transmission Limited

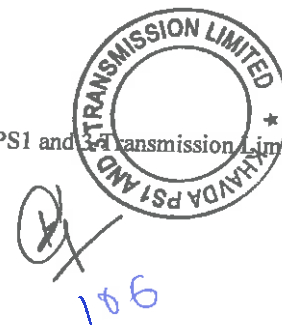
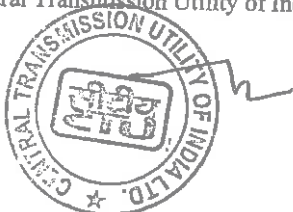

ARTICLE: 17

17. REPRESENTATION AND WARRANTIES

17.1 Representation and warranties of the Nodal Agency

17.1.1 The Nodal Agency hereby represents and warrants to and agrees with the TSP as follows and acknowledges and confirms that the TSP is relying on such representations and warranties in connection with the transactions described in this Agreement:

- a. It has all requisite powers and authority to execute and consummate this Agreement;
- b. This Agreement is enforceable against the Nodal Agency in accordance with its terms;
- c. The consummation of the transactions contemplated by this Agreement on the part of Nodal Agency will not violate any provision of nor constitute a default under, nor give rise to a power to cancel any charter, mortgage, deed of trust or lien, lease, agreement, license, permit, evidence of indebtedness, restriction, or other contract to which the Nodal Agency is a Party or to which the Nodal Agency is bound, which violation, default or power has not been waived;

17.2 Representation and Warranties of the TSP:

17.2.1 The TSP hereby represents and warrants to and agrees with the Nodal Agency as follows and acknowledges and confirms that the Nodal Agency is relying on such representations and warranties in connection with the transactions described in this Agreement:

- a. It has all requisite powers and has been duly authorized to execute and consummate this Agreement;
- b. This Agreement is enforceable against it, in accordance with its terms;
- c. The consummation of the transactions contemplated by this Agreement on the part of the TSP will not violate any provision of nor constitute a default under, nor give rise to a power to cancel any charter, mortgage, deed of trust or lien, lease, agreement, license, permit, evidence of indebtedness, restriction, or other contract to which the TSP is a Party or to which the TSP is bound which violation, default or power has not been waived;



Central Transmission Utility of India Limited



Khavda PS1 and 3 Transmission Limited



Handwritten signature and the number "701" in blue ink.

Transmission Service Agreement

- d. The TSP is not insolvent and no insolvency proceedings have been instituted, nor threatened or pending by or against the TSP;
- e. There are no actions, suits, claims, proceedings or investigations pending or, to the best of the TSP's knowledge, threatened in writing against the TSP at law, in equity, or otherwise, and whether civil or criminal in nature, before or by, any court, commission, arbitrator or governmental agency or authority, and there are no outstanding judgments, decrees or orders of any such courts, commission, arbitrator or governmental agencies or authorities, which materially adversely affect its ability to execute the Project or to comply with its obligations under this Agreement.

17.2.2 The TSP makes all the representations and warranties above to be valid as on the Effective Date of this Agreement.

Central Transmission Utility of India Limited

62

Khavda PS1 and 3 Transmission Limited

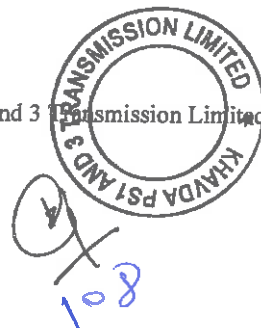
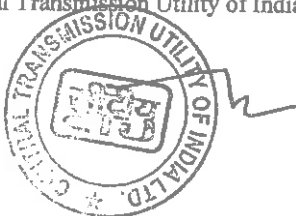

ARTICLE: 18

18. INDEPENDENT ENGINEER

18.1 Appointment of Independent Engineer

The Nodal Agency shall appoint an agency/ company as Independent Engineer as per framework provided in the Guidelines for Encouraging Competition in Development of Transmission Projects for selection of Independent Engineer.

18.2 Roles and functions of Independent Engineer

The role and functions of the Independent Engineer shall include the following:

- a. Progress Monitoring as required under this Agreement;
- b. Ensuring Quality as required under this Agreement;
- c. determining, as required under the Agreement, the costs of any works or services and/or their reasonableness during construction phase;
- d. determining, as required under the Agreement, the period or any extension thereof, for performing any duty or obligation during construction phase;
- e. determining, as required under the Agreement, the valuation of the Project Assets.
- f. Assisting the Parties in resolution of Disputes and
- g. Undertaking all other duties and functions in accordance with the Agreement.

18.3 Remuneration of Independent Engineer

The fee and charges of the Independent Engineer shall be paid by the Nodal Agency as per terms & conditions of appointment.

18.4 Termination of appointment

18.4.1 The Nodal Agency may, in its discretion, terminate the appointment of the Independent Engineer at any time, but only after appointment of another Independent Engineer.

18.4.2 If the TSP has reason to believe that the Independent Engineer is not discharging its duties and functions in a fair, efficient and diligent manner, it may make a written representation to the Nodal Agency and seek termination of the appointment of the

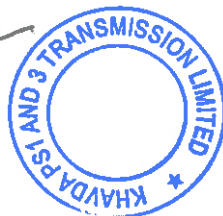
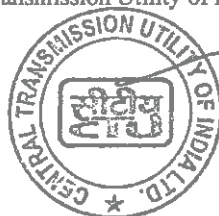

(Handwritten signature)

109



Transmission Service Agreement

Independent Engineer. Upon receipt of such representation, the Nodal Agency shall hold a tripartite meeting with the TSP and Independent Engineer for an amicable resolution, and the decision of Nodal agency is final. In the event that the appointment of the Independent Engineer is terminated hereunder, the Nodal Agency shall appoint forthwith another Independent Engineer.

18.5 Authorised signatories

The Nodal Agency shall require the Independent Engineer to designate and notify to the Nodal Agency up to 2 (two) persons employed in its firm to sign for and on behalf of the Independent Engineer, and any communication or document required to be signed by the Independent Engineer shall be valid and effective only if signed by any of the designated persons; provided that the Independent Engineer may, by notice in writing, substitute any of the designated persons by any of its employees.

Central Transmission Utility of India Limited

64

Khavda PS1 and 3 Transmission Limited

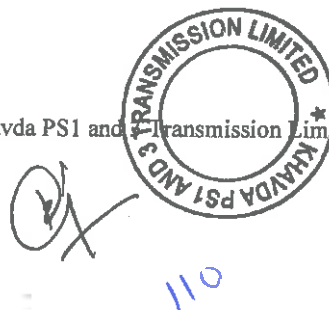

ARTICLE: 19

19. MISCELLANEOUS PROVISIONS

19.1 Equity Lock-in Commitment:

19.1.1 The aggregate equity share holding of the Selected Bidder in the issued and paid up equity share capital of **KHAVDA PS1 AND 3 TRANSMISSION LIMITED** shall not be less than Fifty one percent (51%) up to a period of one (1) year after COD of the Project.

Provided that, in case the Lead Member or Bidding Company is holding equity through Affiliate/s, Ultimate Parent Company or Parent Company, such restriction as specified above shall apply to such entities.

Provided further, that in case the Selected Bidder is a Bidding Consortium, the Lead Member shall continue to hold equity of at least twenty six percent (26%) upto a period of one (1) year after COD of the Project and any Member of such Bidding Consortium shall be allowed to divest its equity as long as the other remaining Members (which shall always include the Lead Member) hold the minimum equity specified above.

19.1.2 If equity is held by the Affiliates, Parent Company or Ultimate Parent Company of the Selected Bidder, then, subject to the second proviso to Article 19.1.1, such Affiliate, Parent Company or Ultimate Parent Company shall be eligible to transfer its shareholding in **KHAVDA PS1 AND 3 TRANSMISSION LIMITED** to another Affiliate or to the Parent Company / Ultimate Parent Company of the Selected Bidder. If any such shareholding entity, qualifying as an Affiliate / Parent Company / Ultimate Parent Company, is likely to cease to meet the criteria to qualify as an Affiliate / Parent Company / Ultimate Parent Company, the shares held by such entity shall be transferred to another Affiliate / Parent Company / Ultimate Parent Company of the Selected Bidder.

19.1.3 Subject to Article 19.1.1, all transfer(s) of shareholding of **KHAVDA PS1 AND 3 TRANSMISSION LIMITED** by any of the entities referred to in Article 19.1.1 and 19.1.2 above, shall be after prior written intimation to the Nodal Agency.

19.1.4 For computation of effective Equity holding, the Equity holding of the Selected Bidder or its Ultimate Parent Company in such Affiliate(s) or Parent Company and the equity holding of such Affiliate(s) or Ultimate Parent Company in **KHAVDA PS1 AND 3 TRANSMISSION LIMITED** shall be computed in accordance with the example given below:

Central Transmission Utility of India Limited

65

Khavda PS1 and 3 Transmission Limited

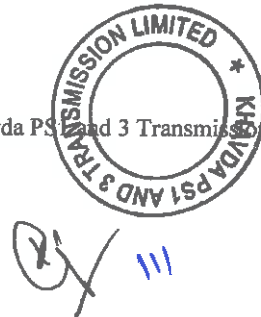
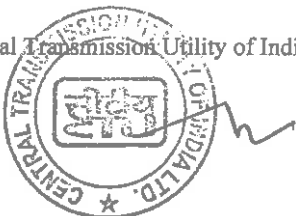

Transmission Service Agreement

If the Parent Company or the Ultimate Parent Company of the Selected Bidder A directly holds thirty percent (30%) of the equity in KHAVDA PS1 AND 3 TRANSMISSION LIMITED, then holding of Selected Bidder A in KHAVDA PS1 AND 3 TRANSMISSION LIMITED shall be thirty percent (30%);

If Selected Bidder A holds thirty percent (30%) equity of the Affiliate and the Affiliate holds fifty percent (50%) equity in KHAVDA PS1 AND 3 TRANSMISSION LIMITED, then, for the purposes of ascertaining the minimum equity/equity lock-in requirements specified above, the effective holding of Bidder A in KHAVDA PS1 AND 3 TRANSMISSION LIMITED shall be fifteen percent (15%), (i.e., 30% x 50%)

19.1.5 The provisions as contained in this Article 19.1 shall override the terms of the consortium agreement submitted as part of the Bid.

19.1.6 The TSP shall be responsible to report to Nodal Agency, within thirty (30) days from the occurrence of any event that would result in any change in its equity holding structure from that which existed as on the date of signing of the Share Purchase Agreement. In such cases, the Nodal Agency would reserve the right to ascertain the equity holding structure and to call for all such required documents / information / clarifications as may be required.

19.2 Commitment of maintaining Qualification Requirement

19.2.1 The Selected Bidder will be required to continue to maintain compliance with the Qualification Requirements, as stipulated in RFP Document, till the COD of the Project. Where the Technically Evaluated Entity and/or the Financially Evaluated Entity is not the Bidding Company or a Member in a Bidding Consortium, as the case may be, the Bidding Company or Member shall continue to be an Affiliate of the Technically Evaluated Entity and/or Financially Evaluated Entity till the COD of the Project.

19.2.2 Failure to comply with the aforesaid provisions shall be dealt in the same manner as TSP's Event of Default as under Article 13 of this Agreement.

19.3 Language:

19.3.1 All agreements, correspondence and communications between the Parties relating to this Agreement and all other documentation to be prepared and supplied under the Agreement shall be written in English, and the Agreement shall be construed and interpreted in accordance with English language.

19.3.2 If any of the agreements, correspondence, communications or documents are prepared in any language other than English, the English translation of such

Central Transmission Utility of India Limited

66

Khavda PS1 and 3 Transmission Limited

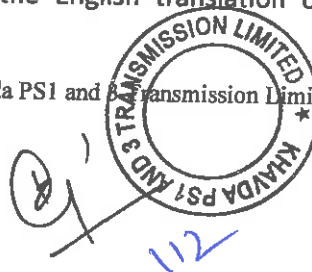
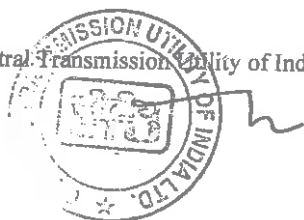

Transmission Service Agreement

agreements, correspondence, communications or documents shall prevail in matters of interpretation.

19.4 Affirmation

The TSP and the Nodal Agency, each affirm that:

1. neither it nor its respective directors, employees, or agents has paid or undertaken to pay or shall in the future pay any unlawful commission, bribe, pay-off or kick-back; and
2. it has not in any other manner paid any sums, whether in Indian currency or foreign currency and whether in India or abroad to the other Party to procure this Agreement, and the TSP and the Nodal Agency hereby undertake not to engage in any similar acts during the Term of Agreement.

19.5 Severability

The invalidity or enforceability, for any reason, of any part of this Agreement shall not prejudice or affect the validity or enforceability of the remainder of this Agreement, unless the part held invalid or unenforceable is fundamental to this Agreement.

19.6 Counterparts

This Agreement may be executed in one or more counterparts, each of which shall be deemed an original and all of which collectively shall be deemed one and the same Agreement.

19.7 Breach of Obligations/ Roles

The Parties acknowledge that a breach of any of the obligations/ roles contained herein would result in injuries. The Parties further acknowledge that the amount of the liquidated damages or the method of calculating the liquidated damages specified in this Agreement is a genuine and reasonable pre-estimate of the damages that may be suffered by the non-defaulting Party in each case specified under this Agreement

19.8 Restriction of Shareholders / Owners Liability

19.8.1 Parties expressly agree and acknowledge that none of the shareholders of the Parties hereto shall be liable to the other Parties for any of the contractual obligations of the concerned Party under this Agreement.

19.8.2 Further, the financial liabilities of the shareholder(s) of each Party to this Agreement shall be restricted to the extent provided in the Indian Companies Act, 1956 / Companies Act, 2013 (as the case may be).

Central Transmission Utility of India Limited

67

Khavda PS1 and 3 Transmission Limited

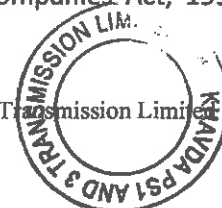
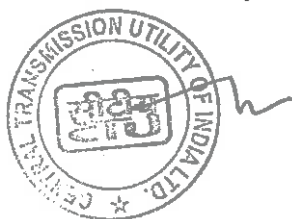

113

19.9 Taxes and Duties:

19.9.1 The TSP shall bear and promptly pay all statutory taxes, duties, levies and cess, assessed/levied on the TSP, its Contractors or their employees that are required to be paid by the TSP as per the Law in relation to the execution of the Project and for providing Transmission Service as per the terms of this Agreement.

19.9.2 The Nodal Agency shall be indemnified and held harmless by the TSP against any claims that may be made against the Nodal Agency in relation to the matters set out in Article 19.9.1.

19.9.3 The Nodal Agency shall not be liable for any payment of, taxes, duties, levies, cess whatsoever for discharging any obligation of the TSP by the Nodal Agency on behalf of TSP or its personnel, provided the TSP has consented in writing to the Nodal Agency for such work, for which consent shall not be unreasonably withheld.

19.10 No Consequential or Indirect Losses

The liability of the TSP shall be limited to that explicitly provided in this Agreement.

Provided that, notwithstanding anything contained in this Agreement, under no event shall the Nodal Agency or the TSP claim from one another any indirect or consequential losses or damages.

19.11 Discretion:

Except where this Agreement expressly requires a Party to act fairly or reasonably, a Party may exercise any discretion given to it under this Agreement in any way it deems fit.

19.12 Confidentiality

19.12.1 The Parties undertake to hold in confidence this Agreement and RFP Project Documents and not to disclose the terms and conditions of the transaction contemplated hereby to third parties, except:

- (a) to their professional advisors;
- (b) to their officers, contractors, employees, agents or representatives, financiers, who need to have access to such information for the proper performance of their activities; or
- (c) disclosures required under Law,

without the prior written consent of the other Parties.

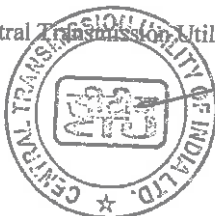

[Handwritten signature]



114

Transmission Service Agreement

Provided that, the TSP agrees and acknowledges that the Nodal Agency, may, at any time, disclose the terms and conditions of the Agreement and the RFP Project Documents to any person, to the extent stipulated under the Law and the Competitive Bidding Guidelines.

19.13 Order of priority in application:

Save as provided in Article 2.5, in case of inconsistencies between the terms and conditions stipulated in Transmission License issued by the Commission to the TSP, agreement(s) executed between the Parties, applicable Law including rules and regulations framed thereunder, the order of priority as between them shall be the order in which they are placed below:

- terms and conditions of Transmission License;
- applicable Law, rules and regulations framed thereunder;
- this Agreement;
- Agreement(s), if any, under Sharing Regulations.

19.14 Independent Entity:

19.14.1 The TSP shall be an independent entity performing its obligations pursuant to the Agreement.

19.14.2 Subject to the provisions of the Agreement, the TSP shall be solely responsible for the manner in which its obligations under this Agreement are to be performed. All employees and representatives of the TSP or Contractors engaged by the TSP in connection with the performance of the Agreement shall be under the complete control of the TSP and shall not be deemed to be employees, representatives, Contractors of the Nodal Agency and nothing contained in the Agreement or in any agreement or contract awarded by the TSP shall be construed to create any contractual relationship between any such employees, representatives or Contractors and the Nodal Agency.

19.15 Amendments:

19.15.1 This Agreement may only be amended or supplemented by a written agreement between the Parties.

19.16 Waiver:

19.16.1 No waiver by either Party of any default or breach by the other Party in the performance of any of the provisions of this Agreement shall be effective unless in

Central Transmission Utility of India Limited

69

Khavda PS1 and 3 Transmission Limited

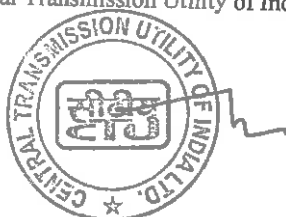

Handwritten signature and initials.

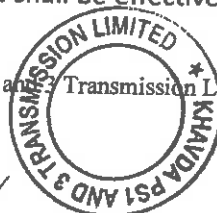

Transmission Service Agreement
writing duly executed by an authorised representative of such Party.

19.16.2 Neither the failure by either Party to insist on any occasion upon the performance of the terms, conditions and provisions of this Agreement nor time or other indulgence granted by one Party to the other Parties shall act as a waiver of such breach or acceptance of any variation or the relinquishment of any such right or any other right under this Agreement, which shall remain in full force and effect.

19.17 Relationship of the Parties:

This Agreement shall not be interpreted or construed to create an association, joint venture, or partnership or agency or any such other relationship between the Parties or to impose any partnership obligation or liability upon either Party and neither Party shall have any right, power or authority to enter into any agreement or undertaking for, or act on behalf of, or to act as or be an agent or representative of, or to otherwise bind, the other Party.

19.18 Entirety:

19.18.1 This Agreement along with its sections, schedules and appendices is intended by the Parties as the final expression of their agreement and is intended also as a complete and exclusive statement of the terms of their agreement.

19.18.2 Except as provided in this Agreement, all prior written or oral understandings, offers or other communications of every kind pertaining to this Agreement or the provision of Transmission Service under this Agreement to the Nodal Agency by the TSP shall stand superseded and abrogated.

19.19 Notices:

19.19.1 All notices or other communications which are required to be given under this Agreement shall be in writing and in the English language

19.19.2 If to the TSP, all notices or communications must be delivered personally or by registered post or facsimile or any other mode duly acknowledged to the addressee below:

	<u>Corporate</u>	<u>Business</u>
Address	: Saudamini, Plot No 2, Sec-29, Gurgaon, Haryana - 122001	: POWERGRID TOR-II RHR, Plot No. 54, Sama - Savli Road, Vadodara, Gujarat - 390024
Attention	: ED (TBCB)	: Sn. G.K. Gautam (Project Incharge)
Email	: tbc@powergrid.in	: gkgautam@powergrid.in
Fax No.	: -	
Telephone No.	: 0124 - 2822123	: 9423762521

19.19.3 If to the Nodal Agency, all notices or communications must be delivered personally or by registered post or facsimile or any other mode duly acknowledged to the

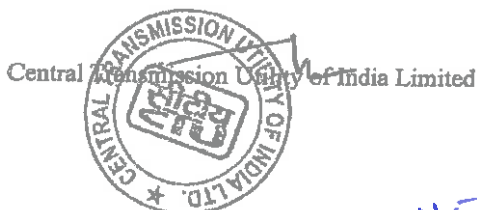

115A

addresses below:

(i) Central Transmission Utility of India Limited (Nodal Agency)

Address : 5th to 10th Floor, IRCON International Tower, Tower
no-1, Plot no -16 , Sector-32, Gurugram, Haryana :122003
Attention : Mr. Atul Kumar Agarwal
Email : atul_ag@powergrid.in
Fax. No. : -
Telephone No. : 9910378059

19.19.4 All notices or communications given by facsimile shall be confirmed by sending a copy of the same via post office in an envelope properly addressed to the appropriate Party for delivery by registered mail. All notices shall be deemed validly delivered upon receipt evidenced by an acknowledgement of the recipient, unless the Party delivering the notice can prove in case of delivery through the registered post that the recipient refused to acknowledge the receipt of the notice despite efforts of the postal authorities.

19.19.5 Any Party may by notice of at least fifteen (15) days to the other Party change the address and/or addresses to which such notices and communications to it are to be delivered or mailed.

19.20 Fraudulent and Corrupt Practices

19.20.1 The TSP and its respective officers, employees, agents and advisers shall observe the highest standard of ethics during the subsistence of this Agreement. Notwithstanding anything to the contrary contained in the Agreement, the Nodal Agency may terminate the Agreement without being liable in any manner whatsoever to the TSP, if it determines that the TSP has, directly or indirectly or through an agent, engaged in corrupt practice, fraudulent practice, coercive practice, undesirable practice or restrictive practice in the Bid process. In such an event, the Nodal Agency shall forfeit the Contract Performance Guarantee of the TSP, without prejudice to any other right or remedy that may be available to the Nodal Agency hereunder or subsistence otherwise.

19.20.2 Without prejudice to the rights of the Nodal Agency under Clause 19.20.1 hereinabove and the rights and remedies which the Nodal Agency may have under this Agreement, if a TSP is found by the Nodal Agency to have directly or indirectly or through an agent, engaged or indulged in any corrupt practice, fraudulent practice, coercive practice, undesirable practice or restrictive practice during the Bid process, or after the issue of Letter of Intent (hereinafter referred to as LOI) or after the execution of the agreement(s) required under Sharing Regulations, the Nodal



115B

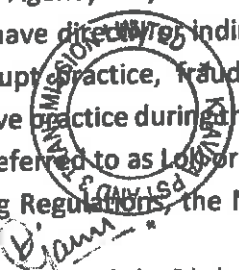

Transmission Service Agreement

Agency may terminate the Agreement without being liable in any manner whatsoever to the TSP. Further, the TSP & its Affiliates shall not

19.20.3 be eligible to participate in any tender or RFP issued by any BPC for an indefinite period from the date such TSP is found by the Nodal Agency to have directly or indirectly or through an agent, engaged or indulged in any corrupt practice, fraudulent practice, coercive practice, undesirable practice or restrictive practices, as the case may be.

19.20.4 For the purposes of this Clause 19.20, the following terms shall have the meaning hereinafter respectively assigned to them:

(a) **"corrupt practice"** means (i) the offering, giving, receiving, or soliciting, directly or indirectly, of anything of value to influence the actions of any person connected with the Bid process (for avoidance of doubt, offering of employment to or employing or engaging in any manner whatsoever, directly or indirectly, any official of the BPC who is or has been associated or dealt in any manner, directly or indirectly with the Bid process or the Lol or has dealt with matters concerning the RFP Project Documents or arising there from, before or after the execution thereof, at any time prior to the expiry of one year from the date such official resigns or retires from or otherwise ceases to be in the service of the BPC, shall be deemed to constitute influencing the actions of a person connected with the Bid Process); or (ii) engaging in any manner whatsoever, whether during the Bid Process or after the issue of the Lol or after the execution of the RFP Project Documents, as the case may be, any person in respect of any matter relating to the Project or the Lol or the RFP Project Documents, who at any time has been or is a legal, financial or technical adviser of the BPC in relation to any matter concerning the Project;

(b) **"fraudulent practice"** means a misrepresentation or omission of facts or suppression of facts or disclosure of incomplete facts, in order to influence the Bid process;

(c) **"coercive practice"** means impairing or harming, or threatening to impair or harm, directly or indirectly, any person or property to influence any person's participation or action in the Bid process;

(d) **"undesirable practice"** means (i) establishing contact with any person connected with or employed or engaged by the BPC with the objective of canvassing, lobbying or in any manner influencing or attempting to influence the Bid process; or (ii) having a Conflict of Interest; and

(e) **"restrictive practice"** means forming a cartel or arriving at any understanding or arrangement among Bidders with the objective of restricting or manipulating a full and fair competition in the Bid process;

19.21 Compliance with Law:

Central Transmission Utility of India Limited

72

Khavda PS1 and 3 Transmission Limited

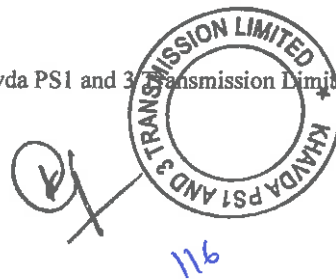
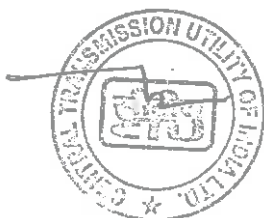



Transmission Service Agreement

Despite anything contained in this Agreement but without prejudice to Article 12, if any provision of this Agreement shall be in deviation or inconsistent with or repugnant to the provisions contained in the Electricity Act, 2003, or any rules and regulations made there under, such provision shall be deemed to be amended to the extent required to bring it into compliance with the aforesaid relevant provisions as amended from time to time.

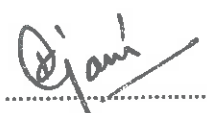
IN WITNESS WHEREOF, THE PARTIES HAVE CAUSED THIS AGREEMENT TO BE EXECUTED BY THEIR DULY AUTHORISED REPRESENTATIVES AS OF THE DATE AND PLACE SET FORTH ABOVE.

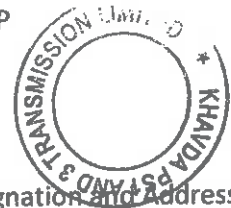
1. For and on behalf of TSP

.....
[Signature, Name, Designation and Address]



2. For and on behalf of Central Transmission Utility of India Limited (Nodal Agency)

.....
[Signature, Name, Designation and Address]

JASBIR SINGH
Executive Director
CENTRAL TRANSMISSION UTILITY OF INDIA LTD.
(A Wholly Owned Subsidiary of
Power Grid Corporation of India Ltd)
(A Government of India Enterprise)
Plot No.-2, Sector-29, Gurgaon- 122 001 (Haryana)

WITNESSES:

1. For and on behalf of
: BPC

..... [Signature]

HK MADHULIKA MURTHY, AM (PFCL)
.....
[Insert, Name, Designation and Address of the Witness]

2. For and on behalf of
: Nodal Agency

..... [Signature]

KAMAL KUMAR JAIN
Senior General Manager
CENTRAL TRANSMISSION UTILITY OF INDIA LTD.
(A Wholly Owned Subsidiary of
Power Grid Corporation of India Ltd)
(A Government of India Enterprise)
Plot No.-2, Sector-29, Gurgaon- 122 001 (Haryana)
.....
[Insert Name, Designation and Address of the Witness]



117

SCHEDULES

Central Transmission Utility of India Limited

74

Khavda PS1 and 3 Transmission Limited

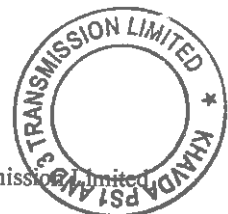
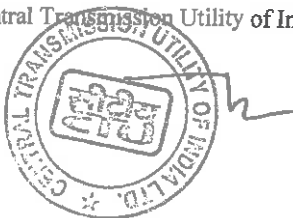

[Handwritten signature]

118

Transmission Service Agreement

Schedule: 1

Project Description and Scope of Project

A. Description of the Transmission Scheme

In order to achieve the commitment made in terms of Nationally Determined Contributions (NDCs), as one of the significant steps, India has pledged to increase the non-fossil fuel based energy capacity to 500 GW by 2030. This is a national mission as a part of the country's energy transition goal.

Towards achievement of the above capacity, 30 GW RE potential has been identified in Khavda area of Gujarat. RE potential in Western Region is concentrated heavily in few pockets (viz. Khavda / Bhuj / Dwarka areas of Gujarat) and power is to be dispatched over long distances to load centres, thereby necessitating long EHV AC systems whose loading shall vary from very low to very high at different times of the day. This shall result in higher voltage variations in the Grid and may even result in line tripping under overvoltage/undervoltage conditions in case the line/bus reactors are not managed in synchronism with the voltage variation. In particular, the voltage variations are observed to be most pronounced at the power injection end (i.e. KPS1, KPS2 and KPS3 S/s) as well the as at drawal end [i.e. Navsari (New) and Boisar-II S/s].

The subject scheme includes provision of Dynamic Reactive Power Compensation [STATCOMs with mechanically switched capacitors (MSC) and reactors (MSR)] at KPS1 and KPS3 substations in Khavda area.

The subject Transmission system was deliberated and recommended to MoP for implementation through the Tariff Based Competitive Bidding (TBCB) route in the 12th National Committee on Transmission (NCT) meeting held on 24.03.2023. Government of India, Ministry of Power vide Gazette notification dated 12.05.2023 (Copy of Gazette notification attached) has appointed PFCCCL as Bid Process Coordinator (BPC) for implementation of the subject transmission scheme through TBCB route.

B. Detailed Scope of Work

Provision of Dynamic Reactive Power Compensation at KPS1 and KPS3		
S. No.	Name of Transmission Element	Scheduled COD in months from Effective Date
1.	<p>300 MVAR STATCOM with 1x125 MVAR MSC, 2x125 MVAR MSR at KPS1, 400 kV Bus section-1 with 1 No. of 400 kV bay (GIS)</p> <ul style="list-style-type: none">± 300 MVAR STATCOM with 1x125 MVAR MSC, 2x125 MVAR MSR400 kV bay (GIS) – 1 No. (KPS1 Bus Section-1)	(07.11.2026)

Central Transmission Utility of India Limited



Khavda PS1 and 3 Transmission Limited

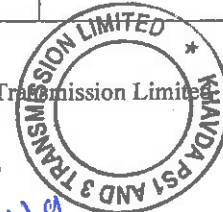

Transmission Service Agreement

2.	<p>± 300 MVAR STATCOM with 1x125 MVAR MSC, 2x125 MVAR MSR at KPS1, 400 kV Bus section-2 with 1 No. of 400 kV bay (GIS)</p> <ul style="list-style-type: none">• ± 300 MVAR STATCOM with 1x125 MVAR MSC, 2x125 MVAR MSR• 400 kV bay (GIS) – 1 No.(KPS1 Bus Section-2)	
3.	<p>± 300 MVAR STATCOM with 1x125 MVAR MSC, 2x125 MVAR MSR at KPS3 400 kV Bus section-1 with 1 No. of 400 kV bay (GIS)</p> <ul style="list-style-type: none">• ± 300 MVAR STATCOM with 1x125 MVAR MSC, 2x125 MVAR MSR• 400kV bay (GIS) – 1 No. (KPS3 Bus Section-1)	

Note:

- (i) TSPs of KPS1 and KPS3 shall provide space for 400 kV bay(s), as may be required, for termination of STATCOM under present scope.
- (ii) Land for installation of STATCOM (with MSC/MSR) as specified above shall be arranged by TSP implementing the STATCOM.
- (iii) Bay(s) required for completion of diameter (GIS) in one-and-half breaker scheme, shall also be executed by the TSP under the present scope.

Central Transmission Utility of India Limited

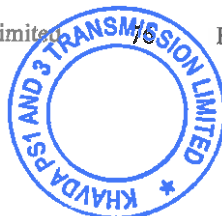
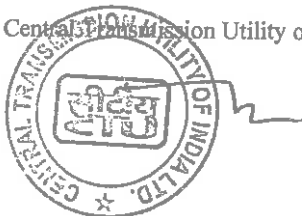

Khavda PS1 and 3 Transmission Limited

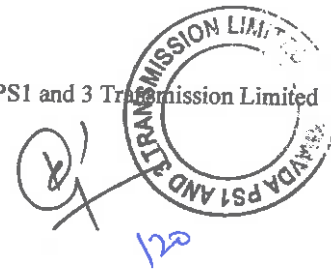

SPECIFIC TECHNICAL REQUIREMENTS FOR STATCOM

The proposed STATCOMs at Khavda PS-1 (KPS1) substation and Khavda PS-3 (KPS3) shall be generally conforming to the requirements of CEA (Technical Standards for Connectivity to Grid) Regulations, 2007 including amendments and CEA (Technical Standards for Construction of Electrical Plants and Electric Lines) Regulations 2022, as amended from time to time. Other CEA Regulations and MoP guidelines, as applicable, shall also be followed and complied with.

A.1 Introduction:

This technical specification for a STATCOM Station consists of STATCOM, MSCs (Mechanically Switched Capacitors) and MSRs (Mechanically Switched Reactors) (to be installed at MV bus) including associated coupling Transformer (rated 400/xx kV) and other equipment connected to the 400 kV bus. MV voltage level (xx kV) of the coupling Transformer can be chosen by the TSP to optimize the offered solution which meets functional requirement of this Technical Specification.

The STATCOM station shall operate asymmetrically in the leading and lagging MVAR regions as applicable to reach the dynamic range specified. The purpose of the STATCOM station is to regulate the voltage of 400 kV Bus Point of Common Coupling (PCC). The Configuration and the nominal rating of the STATCOM station is specified in this document.

The main building block of the STATCOM should be single phase Voltage Source Converter (VSC) based convertor valve (multi-level) operating in a way to eliminate or minimize AC filter requirement to High pass filter only and connected to the xx kV bus through air core reactors.

A.1.1 Definitions and Abbreviations

For the purpose of this specification, the following definitions / abbreviations are used:

PCC: Point of Common Coupling. The connection point between the STATCOM and the power system at which performance requirements are defined.

Reference Voltage (Vref): The Point on the voltage/current (V/I) characteristics where the static synchronous compensator (STATCOM) is at zero output (i.e. where no reactive power is absorbed from, or supplied to, the transmission system where the voltage is controlled)

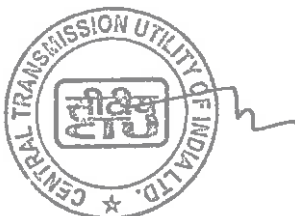

Transmission Service Agreement

MV: Medium Voltage.

STATCOM Unit: Static Synchronous Compensator based on Multi-Module technology and including air cored reactors as needed, Valve cooling, switchgear and its control and protection.

STATCOM: Static Synchronous Compensator consisting of STATCOM Unit(s) connected to a common coupling Transformer. A static synchronous generator operated as a shunt connected compensator, whose capacitive or inductive output current can be controlled independently of the AC system voltage.

MSC: Mechanically Switched Capacitor (Including Switchgear). A shunt-connected circuit containing a mechanical power-switching device in series with a capacitor bank and a current limiting reactor.

MSR: Mechanically Switched Reactor (Including Switchgear). A shunt-connected circuit containing a mechanical power-switching device in series with a reactor.

Sub Module: Basic single power module of a Multi Module STATCOM unit Valve. It is a Part of a STATCOM unit valve comprising controllable switches and diodes connected in full bridge arrangement, together with their immediate auxiliaries, and storage capacitor, if any, where each controllable switch consists of one or more switched valve device(s) connected in series.

Valve: Electrically and mechanically combined assembly comprising of forced commutated devices [for example insulated-gate bipolar transistor(IGBT)] assembled in levels, complete with all connections, auxiliary components, and mechanical structures, which can be connected in series with each phase of the reactor of a STATCOM unit.

Valve Section: Electrical assembly defined for test purposes, comprising one of several sub-modules.

Valve Structure: Physical structure holding valve(s), which is insulated to the full system voltage above earth potential.

STATCOM Station: STATCOM Station includes 400 kV Switchgear, Coupling Transformer, STATCOM, MSCs (as applicable), MSRs (as applicable) along with its switchgear and complete integrated control and protection whose outputs are coordinated. (Complete turnkey delivery at site).

CT: Current Transformer.

VT: Voltage Transformer.

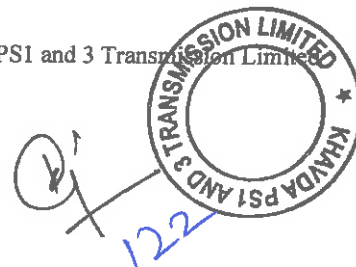

Transmission Service Agreement

SAS: Substation Automation System.

Response Time: the duration from a step change in control signal until the voltage changes by 90% of its final change, before any overshoot.

Settling Time: The duration from a step change in control signal input until the STATCOM output settles to within $\pm 5\%$ of the required control output.

Slope: The ratio of the voltage change to the current change over a defined controlled range of the STATCOM, normally the full (inductive plus capacitive) range at nominal voltage, expressed as a percentage.

VSC: Voltage Source Converter, A forced commutated device (for example, IGBT) based self-commutated converter that is capable of generating AC voltage from DC capacitor.

Voltage/Current (V/I) Characteristic: The relationship between the current of the STATCOM and the voltage at the point of connection.

Lagging Operation: Inductive operation or reactive power absorption of the STATCOM similar to a shunt reactor.

Leading Operation: Capacitive operation or reactive power generation of the STATCOM similar to a shunt Capacitor.

TSP: Transmission Service Provider

A.2 Relevant Standard:

STATCOM Station shall comply with the following standards (latest edition):

Sl. No.	Description	Standards
1	Voltage source converter (VSC) valves for STATCOM	IEC- 62927 IEEE- 1052 IEC-60747
2	Control, protection and monitoring	IEC-61000 IEC-60255
3	Valve Hall for housing the equipment as above comprising of: - wall bushings for connection between converter phases and decoupling reactors, - piping and tubing connections of the cooling system to converter - connection of the control cabinet with the converter through optical fibers - internal lighting, auxiliary power supply (AC	IEC-60071 IEC-60270 IEC-60137

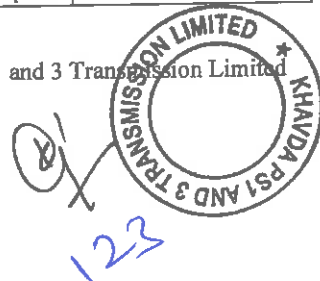

Transmission Service Agreement

	and DC) and power socket system - internal HVAC system	
4	X kV, dry insulated, air core and air self-cooled decoupling reactors. Mechanically Switched Reactors, half-reactors stacked on above the other, Outdoor installation, Complete with supporting structures	IEC- 60076
5	Power Capacitors (MSC etc.)	IEC-60871-1
6	400 kV Power transformer (Coupling Transformer)	IEC-60076 IEC-60354
7	CT's and VT's	IEC- 61869
8	Dis-connectors and Earthing Switches	IEC- 62271
9	HV & MV Circuit Breakers	IEC- 62271
10	Surge Arresters	IEC- 60099
11	Auxiliary & grounding transformer	IEC- 60076 IEEE C57.32 IS- 5553 (Part 6)
12	Neutral Grounding Resistor, charging resistor	IEEE- C57.32
13	UPS, SMPS & Other Power supply units	IEC- 62040 IEC- 61558
14	Cyber Security	IEC-62243

A.3 Scope of work for STATCOM

The scope of work with regard to the works associated with the STATCOM at KPS1 shall comprise of $\pm 1X300$ MVar Modular Multi-level Voltage Source Converter (MMC-VSC) based STATCOM along with 1x125 MVar MSC (Mechanically Switched Capacitors) and 2x125 MVar MSR (Mechanically Switched Reactors) in each 400 kV Bus Sections i.e Bus Section-1 and Bus Section-2.

The scope of work with regard to the works associated with the STATCOM at KPS3 shall comprise of $\pm 1X300$ MVar Modular Multi-level Voltage Source Converter (MMC-VSC) based STATCOM along with 1x125 MVar MSC (Mechanically Switched Capacitors) and 2x125 MVar MSR (Mechanically Switched Reactors) in Bus Section-1.

STATCOM can either be Single/ multiple units. Minimum size of a unit allowed is 150 – 200 MVar. TSP shall ensure that there are no coordination issues between

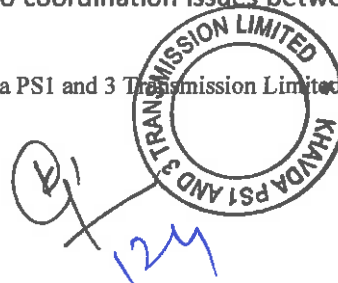
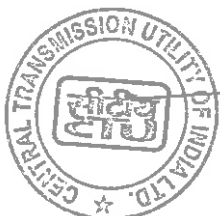

Transmission Service Agreement

multiple STATCOM branches of STATCOM station. Further complete Dynamic range for STATCOM may also be installed based on appropriate studies instead of combination of VSC with MSC/MSR technology. Minimum MV bus voltage is to be decided by OEMs.

The TSP shall be responsible for the complete installation of STATCOM station along with the substation works as specified in the complete scope of work.

The TSP shall also perform the system studies (steady state and dynamic) according to the requirement mentioned and documentation of the same shall be preserved by TSP and to be submitted to CEA/CTU/GRID-INDIA, as per their request.

TSP shall carry out a detailed study on prevailing system conditions before interconnection of the STATCOM to assess the performance of the STATCOM. Parameters tuning to avoid any adverse impact on the grid with integration of the STATCOM shall also be identified and implemented at this stage. TSP shall carry out tuning of Power Oscillation damping (POD) along with an interaction study with nearby HVDC/FACTS controllers.

TSP shall ensure interconnection study at the time of commissioning and shall also be responsible for tuning the POD during the license period as per relevant standards (e.g. IEEE 1052).

The switchgear for connection of STATCOM units, MSCs and MSRs provided on the secondary side of the coupling transformer shall be of standard voltage rating as per relevant IEC. The switchgear, structure, control, protection and substation automation on the 400 KV side shall be as per applicable Technical Specification of the substation equipment.

Generally, the purpose of STATCOM is to improve system stability, provide damping, and smooth out the step voltage change associated with MSCs, MSRs and external compensating equipment (i.e. any existing capacitor and reactor banks) switching and provide steady state VARs as needed to support the 400 kV bus voltage.

In order to get optimum control of MVAR, the control of MSCs and MSRs, as well as reactor banks connected on the 400 kV HV side, may be integrated along with STATCOM control to provide steady state 400 kV bus voltage control in a smooth manner. MSRs and MSCs are to be switched to relieve the STATCOM from high level operation, reduce its continuous losses and maximize its dynamic control potential. There should be a provision for the independent operation of MSC/MSR after delinking it with STATCOM controls when STATCOM is out of service due to any reason. Switching of MSC/MSR shall be based on value of external bus voltage.

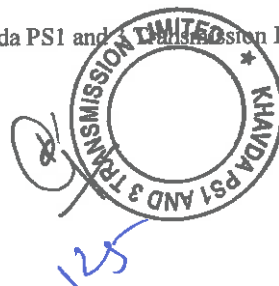
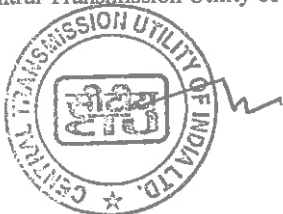

Transmission Service Agreement

The operating functions of the STATCOM Station shall include:

- Steady state voltage control of 400 kV bus,
- Balance steady state voltage at 400 kV bus,
- Dynamic over-voltage control,
- Transient and Dynamic stability control
- Damping of Power Oscillations

It is assumed that the arresters will limit any transient and switching surge over voltages and may also, by design, limit dynamic over voltages.

The requirement of reactive power compensation (as defined above) guaranteed by the TSP shall not be less than the levels specified considering following.

- The total cumulative Capacitive (+) and Inductive (-) MVAR rated Capacity of STATCOM Station as defined above comprising of STATCOM, MSCs (as applicable), MSRs (as applicable) coupling transformer, coupling reactor or any filter (if applicable) shall be rated at 1 pu voltage, 1 pu frequency and 50 ° C (Celsius) ambient temperature at 400 kV Bus (Referred to as "Point of Common Coupling" or PCC).
- Capacity of one or more branches of MSC, MSR in STATCOM Station can be included in the STATCOM with equivalent capacity. Accordingly, ratings of STATCOM Unit/Branch equipment may be designed.

Example of equivalent acceptable solutions for each STATCOM Station is given below:

Option 1: ±300 MVAR STATCOM, 1x125MVAR Mechanically switched Shunt Capacitor (MSC), 2x125MVAR Mechanically switched Shunt Reactor (MSR).

Option 2: +425/-300 MVAR STATCOM, 2x125 MVAR Mechanically switched Shunt Reactor (MSR).

Option 3: +300/-425 MVAR STATCOM, 1x125 MVAR Mechanically switched Shunt Capacitor (MSC), 1x125 MVAR Mechanically switched Shunt Reactor (MSR).

Option 4: ±425 MVAR STATCOM, 1x125MVAR Mechanically switched Shunt Reactor (MSR)

Option 5: +425/-550 MVAR STATCOM

- The rated capability of STATCOM, MSC (as applicable) and MSR (as applicable) shall be at 400 kV (Referred to as "Point of Common Coupling" or PCC) and in the steady state frequency range of 48.5 Hz-50.5 Hz.

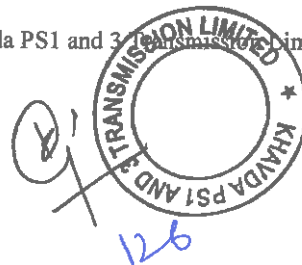
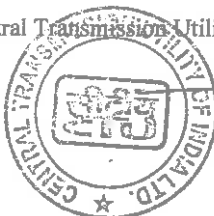

Transmission Service Agreement

- The STATCOM Station including STATCOM Units, MSCs and MSRs shall be designed to operate continuously under the worst possible combination of steady state voltage range of 360-440 kV and frequency range of 47.5 Hz – 52.5 Hz respectively and transient and temporary over voltages defined in Clause 6.1-f).
- The AC voltage unbalance at fundamental frequency shall be assumed equivalent to a negative phase sequence component of 1.5% for equipment rating purposes.
- The reactive power compensation levels shall be determined by manufacturing tolerances of the components and measurements carried out using metering accuracy instrumentation at the 400 kV feed points to the STATCOM Station.
- The reactive power capability shall also be determined by calculations based on test values of appropriate quantities at the discretion of the owner.
- In calculations of capability and availability, the owner shall assume the most unfavourable combinations of control, manufacturing and measurement tolerances.
- In case more than one STATCOM Station are installed in a particular substation, each STATCOM Station shall be connected to 400kV bus individually with complete separate downstream system. Each individual STATCOM station shall have complete independent yet coordinated control system to avoid simultaneous tripping of both STATCOM Stations. The system shall be design in such a way that single common contingency (other than loss of 400kV voltage, abnormal system events) will not cause tripping of both STATCOM Stations.
- Operation of STATCOM Station shall not excite any resonance condition in connected Power System.
- Control of STATCOM Station shall be designed to prevent hunting between MSRs, MSCs and STATCOM.

A.3.1 STATCOM building

The STATCOM station shall have independent building including a separate control room different from the main control room building of the 765/400kV Substation.

The STATCOM Building shall comprise of following facilities

1. Control & Relay Panel room
2. ACDB & DCDB room
3. Battery room
4. Service Room cum workshop
5. Conference room



Transmission Service Agreement

6. Valve hall
7. Cooling system room
8. Lobby
9. Corridor with minimum width of 1600 mm
10. Portico
11. Common Toilet
12. Provision of shaft for electrical, sanitary, water supply facilities
13. Other facilities as per functional requirement of building
14. AHU Room

A.4 Ambient Condition

STATCOM Station should be designed to perform at 50 degrees C ambient temperature

A.5 Power System Characteristic

The following AC power system characteristics apply at the point of connection i.e. point of common coupling in this case (PCC). STATCOM station operation is required within the parameter value and duration given in following table:

S. No	Power System Characteristic	Value	unit
1.	Nominal ac system voltage, line-to-line	400	kV
2.	Maximum continuous ac system voltage, line-to-line	420	kV
3.	Minimum continuous ac system voltage, line-to-line	380	kV
4.	Maximum short-term ac system voltage, line-to-line	448	kV
5.	Maximum duration of item 4	10	s
6.	Minimum short-term ac system voltage, line-to-line	120	kV
7.	Maximum duration of item 6	5	s
8.	Continuous negative-sequence voltage component (used for performance calculation)	1	%
9.	Continuous negative-sequence voltage component (used for rating calculation)	1.5	%
10.	Continuous zero-sequence voltage component	1	%
11.	Nominal ac system frequency	50	Hz
12.	Maximum continuous ac system frequency (for rated output)	50.5	Hz
13.	Minimum continuous ac system frequency (for rated output)	48.5	Hz

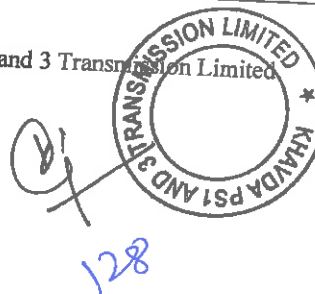
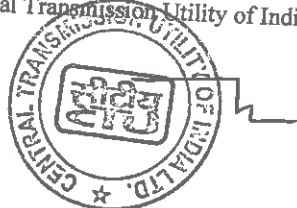

Transmission Service Agreement

S. No	Power System Characteristic	Value	unit
14.	Maximum short-term ac system frequency	52.5	Hz
15.	Minimum short-term ac system frequency	47.5	Hz
16.	Basic Insulation Level (BIL)	1550	kV peak
17.	Switching impulse level (SIL)	1050	kV peak
18.	Power Frequency Withstand voltage	630	kV
19.	1) Maximum three-phase fault current a) for performance requirements b) for rating of STATCOM KPS1 (Bus Section-1) X/R (Positive/Negative Seq)* X/R (Zero Seq)* Clearing time - normal Clearing time – backup KPS1 (Bus Section-2) X/R (Positive/Negative Seq)* X/R (Zero Seq)* Clearing time - normal Clearing time – backup KPS3 (Bus Section-1) X/R (Positive/Negative Seq)* X/R (Zero Seq)* Clearing time - normal Clearing time – backup	1 a) 63 1 b) 63 31.06 19.24 0.10 0.75 30.46 28.49 0.10 0.75 30.60 28.40 0.10 0.75	kA kA for 1s s s s s s s
20.	Maximum three-phase fault current	63	kA
21.	Minimum three-phase fault current # KPS1 (Bus Section-1) -for performance requirements -for safe operation KPS1 (Bus Section-2) -for performance requirements -for safe operation KPS3 (Bus Section-1) -for performance requirements -for safe operation	19.9 19.9 19.9 19.9 18.9 18.9	kA kA kA kA kA kA
22.	Maximum single-phase fault current	63	kA

Central Transmission Utility of India Limited

Khavda PS1 and 3 Transmission Limited

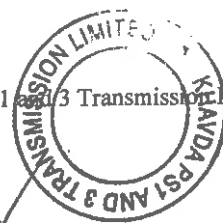
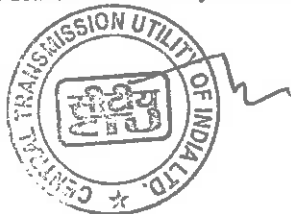

129

Transmission Service Agreement

S. No	Power System Characteristic	Value	unit
23.	Minimum single-phase fault current#		
	KPS1 (Bus Section-1)	26.7	kA
	KPS1 (Bus Section-2)	29.7	kA
	KPS3 (Bus Section-1)	28.6	kA
24.	Harmonic impedance sectors for each harmonic number up to the 49th harmonic or system impedance data as R-X values with frequency steps not larger than 1 Hz (for performance and/or STATCOM system component rating)	Chapter 7.3 of CIGRE Publication 139	
25.	Background harmonic voltage (or current) spectrum (for STATCOM components rating) (Distortion up to 15th Harmonic)	5th Harmonic 1.5% 7th Harmonic 1.0% Other Harmonics 0.5% (each)	
26.	Power System Phase Rotation	CCW	

** The short circuit calculations have been carried out using the classical method with flat pre-fault voltages and sub-transient reactance of the machines. Sub-transient reactance of IBRs considered as 1 pu in Khavda area.*

#Calculated considering outage of 2 nos. 765/400kV ICTs at each of KPS1 (Bus section 1), KPS1 (Bus section 2) and KPS3 (Bus section 1) and NIL fault contribution from IBRs in Khavda area.

For STATCOMs near RE complex: The STATCOMs shall remain connected to the grid and shall be able to operate at rated reactive power capability when voltage at the interconnection point, on any or all phases dips up to the level depicted by the thick lines in the following curve (for specified time):

VT : Actual Voltage; Vn: Nominal Voltage

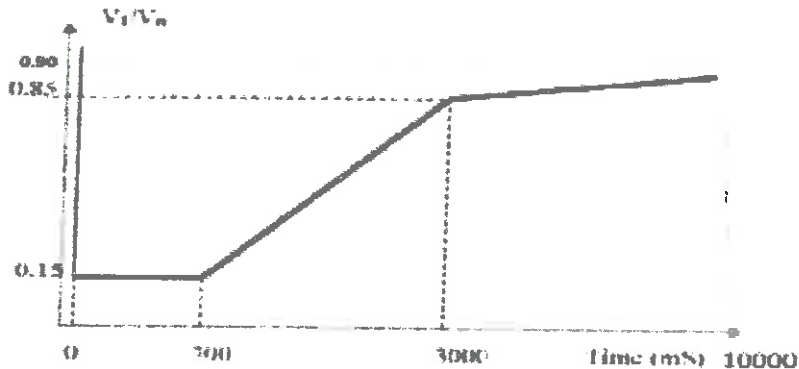

A.6 STATCOM Station Characteristics

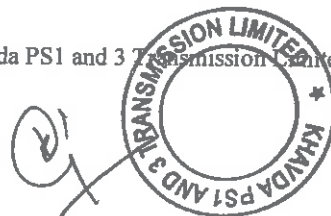

Transmission Service Agreement

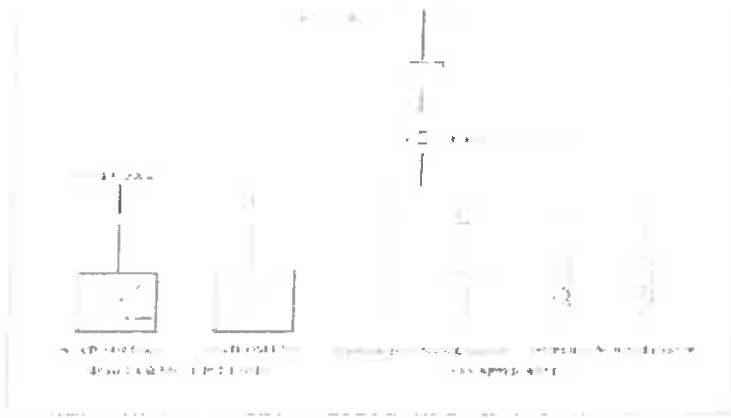

Figure-1: Conceptual Indicative Schematic diagram of STATCOM Station

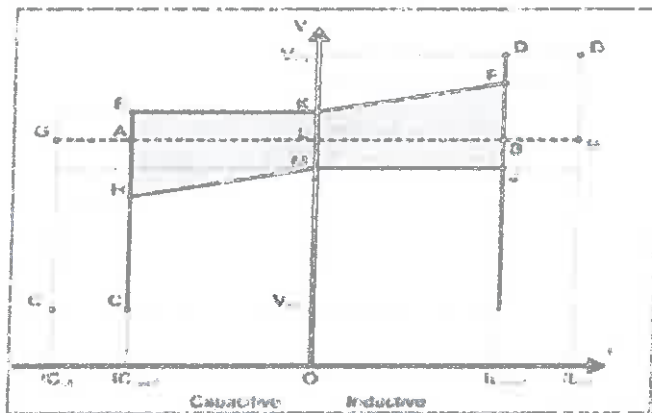

Figure-2: VI Curve of the VSC Portion

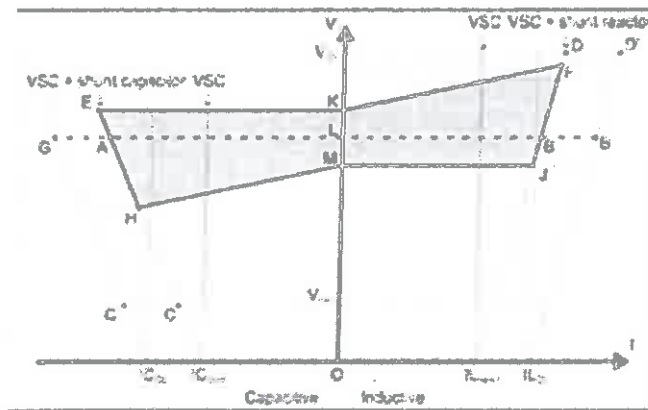
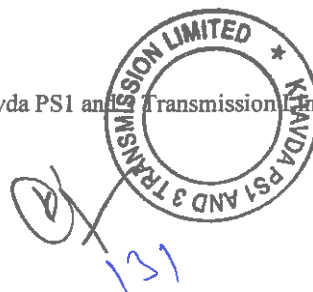

Figure-3: VI Curve of the STATCOM Station

A.6.1 STATCOM Station Ratings

Central Transmission Utility of India Limited

Khavda PS1 and 3 Transmission Limited



Transmission Service Agreement

The output of a STATCOM Station shall be adjusted continuously over the range illustrated in Figure-3.

The following items define the ratings of the STATCOM station equipment.

- a) The STATCOM Station should regulate the 400kV bus voltage to a reference voltage of 400kV (1.0 per unit, Point L Figure-3), continuously adjustable between 0.95 per unit and 1.05 per unit.
- b) The nominal capacitive and inductive reactive power output of the STATCOM should be as defined in the scope, at 1.0 pu ac bus voltage and nominal system frequency f , and 50°C ambient temperature (Point A and point B of figure-2).
- c) The slope of the STATCOM Station characteristic should be adjustable in steps of not greater than 0.5% between 1% and 8%, on a basis of cumulative MVA capacity of STATCOM Station (A+B in Figure-3).
- d) The STATCOM Stations near RE Complex shall continue to inject reactive power during temporary under voltage down to 60 kV (0.15 pu) for the duration 0.3 sec (Point C) and STATCOM behavior for voltages above 0.15 pu shall be as specified under section A.5 above, which also specifies operation at under voltage down to 120 kV (0.3 pu) for the duration 5 sec; the STATCOM system may be tripped (or blocked) if the under voltage persists for time beyond limits specified under section A.5 above.

The STATCOM Stations (other than RE Complex) shall continue to inject reactive power during temporary under voltage down to 120 kV (0.3 pu) (Point-C) for the duration 5 sec; the STATCOM system may be tripped (or blocked) if the under voltage persists for time beyond limits specified under section A.5 above.

- e) The STATCOM shall continue to absorb reactive power during HVRT Conditions in a controlled manner as per the following.

Nominal Voltage (pu)	Minimum time for remaining connected to the Grid
$V > 1.50$	Instantaneous trip
$1.50 \geq V > 1.30$	100 milli seconds
$1.30 \geq V > 1.10$	10 seconds
$V \leq 1.10$	Continuous

STATCOM Station may be tripped if the respective temporary over voltages as mentioned above persists for more than its respective mentioned

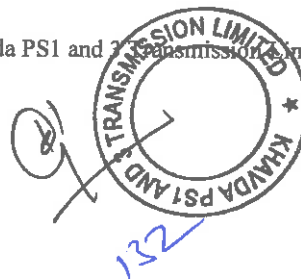
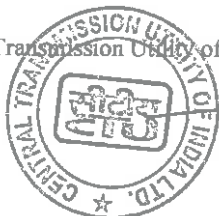

Transmission Service Agreement

duration.

- f) The STATCOM Station should be capable of repeating temporary operation as defined in any one of item (d) and (e) as above for at least 3 charging cycles in 60 mins.
- g) The coupling transformer and all bus equipment, such as filter branches (if applicable), MSC & MSR branches etc. and the MV Bus should be rated to withstand the specified continuous and short-term operation, and to withstand or be protected against voltage and current stresses that exceed these conditions.
- h) All equipment in the STATCOM Station should be capable of sustaining, without damage, any fault limited by the maximum design short circuit level of the system and the Coupling transformer impedance.
- i) The TSP shall assume the negative sequence voltage of 1% at rated short circuit level and provide control to reduce this unbalance.
- j) The injected harmonics by STATCOM Station under the full operating range measured at 400 kV Bus (PCC) in accordance with IEEE-519-2014 and limiting values of individual voltage harmonic distortions and total harmonic distortion shall be 0.5% and 1% respectively.
- k) The STATCOM controls should be designed to correct negative sequence voltage during steady state operation.
- l) The switching module design should include an appropriate allowance for stray capacitance and component tolerances.
- m) The STATCOM should be designed to prevent, or alternatively to withstand, false firing events, i.e., the firing of any valve at an incorrect time in the cycle or when not ordered.

A.6.2 Control Objectives

The control system shall control the STATCOM, MSCs, MSRs required under this specification, as well as all bus reactors on the 400kV HV bus of the substation.

Operation logic for the breakers, disconnectors and earth-switches in the STATCOM Station shall also be incorporated in the control system. The control shall be programmable and shall have sufficient scope and flexibility (software programming margin of at least 20%) to permit re-programming according to future changes/addition in the power system. The operator interface must be integrated in a latest version of Windows environment.

A.6.2.1 STATCOM Station Functions and Applications

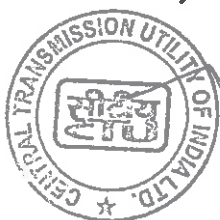

A.6.2.1.1 Voltage Control mode (Automatic and Manual)

Control of the positive sequence component of the fundamental frequency voltage in steady state at POI , with slope in the range as specified at clause 6.1 c) above.

There shall be following provisions in STATCOM System to operate in Voltage Control Mode:

- a) To adjust the reference voltage for changes by Grid operator.
- b) To adjust the value of reactive power droop in pu to provide a stable, coordinated and dynamic response.
- c) To adjust the voltage dead band with a minimum magnitude of ± 0.05 pu

A.6.2.1.2 Fixed Reactive Power Mode

In this mode, the STATCOM system shall maintain a specified constant reactive power output at the POI under continuous / steady state operating region. The target reactive power level and mode (injection or absorption) shall be specified by the Grid operator. There shall be a provision to adjust the reactive power set point. The dynamic response of the STATCOM system to any changes in reactive power shall be positively damped with a damping ratio of 0.3 or better.

A.6.2.1.3 Steady State Condition

The STATCOM Station (STATCOM along with MSCs and MSRs) shall provide necessary reactive power support to the 400kV bus (PCC) to compensate for voltage variation under steady state.

A.6.2.1.4 Dynamic Over-voltage Control Performance

The STATCOM shall be required to provide necessary reactive power support with fast and smooth variation so that over-voltages under dynamic conditions are controlled. STATCOM shall smooth out the step caused by the switching of MSCs and MSRs.

The operation of each STATCOM over its range of MVAR from full capacitive to full Inductive capacity and vice-versa shall be on the basis of smooth variation.

A.6.2.1.5 Transient and Dynamic Stability Performances

The STATCOM Station shall provide necessary reactive power so that the transient and dynamic stability of the Owner's system is enhanced.

A.6.2.1.6 Damping of Power Oscillations

The STATCOM shall provide necessary damping to power oscillations by

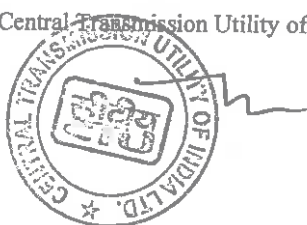

Transmission Service Agreement

modulating its output in its entire range based on the measured rate of change of power/frequency at the 400 kV bus. The damping controller would track local area oscillations as well as wide area oscillations and control would include several loops each focused on different frequencies.

TSP shall ensure the damping of oscillation during the entire license period including the pre-commissioning period as per relevant standards. (e.g. IEEE 1052).

A.6.2.1.7 Facility for compensation of phase imbalance

Provide negative phase sequence voltage control to minimize the presence of negative sequence content of the 400 kV bus voltage.

A.6.2.1.8 Start up and Initial Switching

The operation of STATCOM Station during start-up/initial switching on should not create significant energizing transients causing voltage drop, voltage distortion and swinging of transmission voltage angle at the PCC bus by more than +/-5%. TSP shall have to ensure this analytically during the design phase and also in the field after the commissioning of the facility. TSP shall prepare the design documentation and the same shall be preserved by TSP and to be submitted to CEA/CTU/GRID-INDIA, as per their requirement.

A.6.2.1.9 Gain Supervision and Control

To control the regulator gain in order to prevent oscillations and excessive overshoot in the STATCOM response, a gain supervision function shall be implemented. This shall be an essential function for the supervision of stability of closed-loop voltage control. The function of this controller is that when the supervision of the gain in the voltage regulator detects oscillations in the voltage controller output, the gain shall gradually be reduced until stability is reached. Normally it is a changed condition in the transmission system contribution to the closed loop gain that results in instability. The reduction in the voltage regulator gain shall only balance the external change. The control should be adaptive in order to maximize its effectiveness. Gain reductions should be indicated and the reduction of the gain shall be able to be reset to nominal value by means of commands from the operator interface or automatically. A relative gain factor shall also be able to be changed from a gain optimizer.

A.6.2.1.10 Coordinated reactive power control of external devices

To optimize the use of dynamic VARs versus steady state VARs, control of externally connected shunt capacitor or reactor banks shall be implemented. Such banks will be connected locally to a HV bus or/and at MV bus. For simultaneous

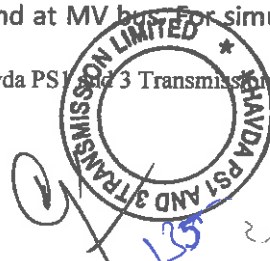

Transmission Service Agreement

control with the supplementary VSC current controller, coordination for the two functions shall be provided. External devices like mechanically switched capacitors (MSC)/mechanically switched reactors (MSR) can be switched ON or OFF to position the steady state operating point of the VSC so as to extend its dynamic range. There should be a provision for independent operation of MSC/MSR after delinking it with STATCOM controls when STATCOM is out of service due to any reason. The threshold values for switching the MSC/MSR on/off shall be configurable in all modes of operation.

A.6.2.1.11 Supplementary VSC current controller

To optimize the use of dynamic VARs versus steady state VARs, a control function that slowly reduces or offsets the STATCOM point of operation shall be implemented. By deliberately adjusting the voltage reference setting within a narrow window the STATCOM system output is pushed towards either a specific point or towards a window to preserve dynamic range. This slow operating function is meant to provide for slower controllers, such as externally connected shunt banks to operate and meet the slower long term voltage variations caused by daily or weekly load variations. Rapid changes in the system voltage that call for dynamic compensation will have priority over this type of controller.

A.6.2.1.12 Gain optimization

To provide operation at optimal regulator gain, a fully automatic optimizing function shall be implemented. This function operates by inducing a small change in the STATCOM output. The gain is adjusted based on the network response signal.

A.6.2.1.13 Control of Direct Current

During STATCOM operations, any flow of direct current to the transformer's MV side must be less than 25% of the transformer magnetizing current. DC current flow in the transformer should be minimized by an independent control function that minimizes DC current. For presence of up to 0.2% second harmonic in 400 kV system, the STATCOM control should minimize DC current flow in the transformer.

A.6.2.2 Under Voltage Strategy

It is essential that the STATCOM Station operates in a robust manner when transmission system under voltages appears. For transmission system voltages down to 0.135 pu, the STATCOM units must operate unrestricted, producing its rated capacitive current. The STATCOM must be designed to operate at transmission system under voltage, even considering that severe voltage unbalances can appear. The STATCOM must not be restricted in short term

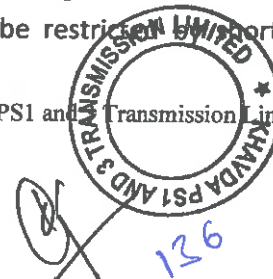
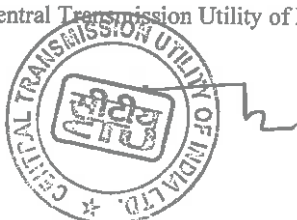

Transmission Service Agreement

negative sequence voltages up to 1.5%, appearing in conjunction with under voltages.

Transmission system under voltages below 0.135 pu will appear in conjunction with transmission system faults. The STATCOM must ride through during faults and post fault under voltages. The minimum trip delay for the STATCOM Station, upon complete loss of the transmission system voltage shall not be less than 5 seconds. If station AC auxiliary power distribution is affected, critical loads must be fed from DC station batteries, uninterrupted power supply (UPS) without tripping the STATCOM Station. Adequate capacity must be kept in DC station batteries, UPS to feed critical loads for the smooth operation of the STATCOM Station facility. There must be redundant station battery system with each station battery system capable of delivering 100% load.

At under voltage conditions for the transmission system voltage, special control strategies are activated which override the normal control modes presented above. Normally if the voltage is low, the output from the STATCOM will be capacitive. If the voltage in all three phases goes below a level, but not greater than 0.135 pu, a special under voltage strategy may be activated that controls the STATCOM output to 0 MVar. As soon as the voltage goes higher than 0.135 pu, the under voltage strategy is deactivated and the normal control will be in operation (for the specified duration).

The STATCOM Station must not be tripped or shut down automatically due to under voltages appearing for specified duration as specified under section A.5 above. STATCOM Station must continue to operate when AC system Voltage on any or all phases dips down to 0.135 pu voltage as per the characteristic given at section A.5.

A.6.2.3 Over Voltage Strategy

A.6.2.3.1 The TSP shall carry out dynamic stability study upfront in order to assess the dynamic overvoltage requirements. These studies shall include conditions with maximum and minimum short circuit system MVA conditions, single phase and three phase faults as well as stuck breaker, outage of the nearby generator and also with the outage of parts of the STATCOM Station. It is important that the STATCOM Station rides through temporary over voltages and not trip when it is needed the most.

A.6.2.3.2 The system should be able to withstand any 3 phase, 5 cycle (100 ms) and single phase 10 cycles (200 ms) fault with consequent loss of a 400 kV double circuit line and loss of a 500 MW generator. The fault duration mentioned above corresponds to time assumed for the persistence of fault. For other system parameters refer clause 5 above

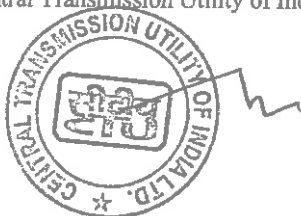

Transmission Service Agreement

(Power System Characteristics). In addition to above requirement, system contingency cases as provided in Annexure-I need to be considered and satisfied.

A.6.2.3.3 The 400kV system and equipment to which the STATCOM Station is connected is designed to withstand switching surge overvoltage up to 2.5 pu and power frequency over voltages up to 1.5 pu with initial value of the temporary overvoltage up to 2.0 pu for 1-2 cycles. Based on arrester coordination and under the worst case scenario the 400 kV system phase to ground peak over voltages may be expected as follows

- i) 650 kVp for 03 peaks
 - ii) 575 kVp up to 5 cycles
 - iii) 530 kVp up to 1 second
 - iv) 475 kVp up to 10 seconds
- a) The STATCOM Station shall be designed to withstand these sequential over voltages.
 - b) If the over voltages greater than 1.1 pu are exceeded in magnitude and duration due to any system contingencies, suitable control action shall be taken by STATCOM Station to bear this kind of contingency.
 - c) The TSP shall evolve the insulation co-ordination of the components of the STATCOM Station after studies have been conducted to determine the over-voltage profile with the STATCOM connected to the system.
 - d) The TSP shall ensure that STATCOM Station will not excite ferro-resonance and sub-synchronous oscillation in the AC system. The study report in this regard shall be preserved and to be submitted to CEA/CTU/GRID-INDIA, if required.
 - e) It may also be noted that the tripping action for 400 kV lines is initiated if the overvoltage exceeds 1.12 pu for 10 seconds. The tripping of 400 kV lines is initiated if 1.5 pu voltage persists for more than 100 milli seconds. The over voltage strategy shall be coordinated with these settings such that the STATCOM Station rides through up to these levels.

A.6.2.4 STATCOM Station Over load / Over Current

The overvoltage cycles mentioned in clause 6.2.3.3 above create a corresponding current overload in the STATCOM Station components; the STATCOM Station and its components shall be designed to withstand these. In addition to the above the STATCOM Station and its components shall be designed to withstand overloading caused due to the following eventualities.

- i) Short circuits and ground faults in the 400 kV system especially those

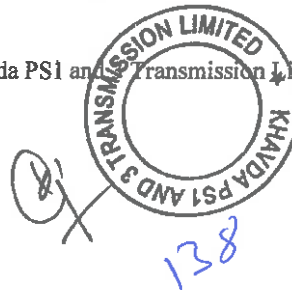
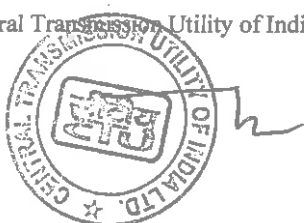

Transmission Service Agreement
occurring near the STATCOM Station and medium voltage bus of the
STATCOM Station.

- ii) Transient overvoltage due to switching operations and atmospheric effects.
- iii) Temporary over voltages.
- iv) Short circuits in the transformer secondary circuit such as:
 - Bushing terminal fault
 - Flashover across a reactor, Bus Bar and other connected components/switchgear etc.
- v) Protection system faults.

If the rated overvoltage is exceeded as a result of prolonged stressing or for other reasons, the protection specified elsewhere in the specification shall come into effect to prevent damage.

A.6.2.5 Dynamic Performance Controls of STATCOM Station

The TSP must describe in detail, the dynamic reactive power controls for enhancing stability margin and also damp oscillations of any critical frequencies. The dead band for continuous damping control must be very small so that there are no discernible sustained oscillations.

A.6.2.6 Protective Control Functions

TSP shall provide all necessary protections including Main and Back-up protections for all protective zones and equipment like transformers, STATCOM Units, MSCs (if applicable), MSRs (if applicable), MV Bus Bar etc. TSP shall provide any protective control functions to meet the performance requirement of STATCOM under the scope of the TSP.

a) Overvoltage Protection

TSP shall provide adequate overvoltage protection as a result of any normal operation, mal-operation or system event.

b) Over current Protection

TSP shall provide adequate over-current protection for the STATCOM Station as a result of any abnormal operation, mal-operation or system event.

c) Gate level control Supervision

TSP shall provide adequate Sub module Gate level control supervision.

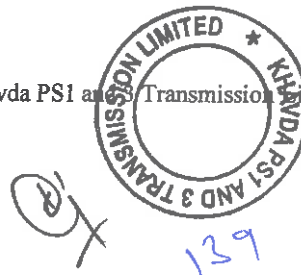
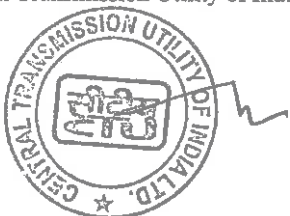

A.6.2.7 STATCOM Station Response

STATCOM station response shall be such that the change in measured system voltage to small disturbance should reach 90% of the desired total change within 30 ms of initiating a 5% step change of voltage reference. The maximum overshoot should not exceed 120% of the total change and the settling time should not exceed 100 ms, after which the voltage should be within $\pm 5\%$ of the final value. This response characteristic within these limits must be respected when the system's three-phase fault MVA is between the minimum and maximum value defined in clause-5. The response of the system voltage using the actual controller should be validated on a real time simulator during the factory acceptance test (FAT) at the manufacturer's premises. For the purpose of STATCOM Station, response time measurement and signal conversion of the voltage, the error should not exceed 0.3%. The voltage response acquisition circuit should have a response time of no longer than 10 ms. However, time longer than 10 ms can be allowed provided the requirement of STATCOM response time is met.

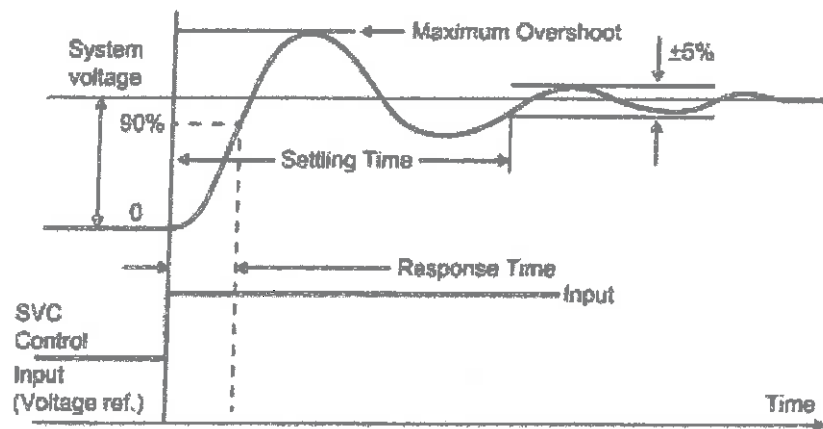

Figure-4 Response and Settling time

A.6.3 Harmonic performance and AC harmonic filter design

It is likely that with multi-level VSC based technology, no filters or only a small high-pass filter will be needed. The STATCOM shall be operable without AC filters. The STATCOM Station should be designed to eliminate the effects of any harmonic resonance between its MSRs, MSCs banks, filter branches, and the AC system. To limit the harmonic distortion imposed on the 400 kV transmission system, the additional contribution of harmonic distortion from the STATCOM Station to 400 kV system (PCC) should not exceed 1% for the total and 0.5% for any specific harmonic.

A.6.3.1 Filter performance

The distortion levels as specified should be met for the following:



Transmission Service Agreement

- a) The continuous range of all system and environmental conditions.
- b) Variation in total filter capacitance due to manufacturing tolerance, ambient temperature, aging, and changes in capacitance up to alarm level.
- c) Variation in tolerance for STATCOM parameters, such as transformer winding unbalances, valve firing variations MSC and MSR unequal reactor and capacitor reactance between phases.
- d) System frequency in the range of 48.5 Hz to 50.5 Hz. Calculation should take into account all possible combinations of STATCOMs, MSCs and MSRs.

A.6.3.2 Filter component rating

The harmonic filter components (and other STATCOM components) should be rated to carry continuously the harmonic currents caused by the background harmonic distortion of the system and the harmonic currents produced by the STATCOM itself. Unless otherwise specified, harmonic currents from the system and the STATCOM of the same order should be added arithmetically. All filter harmonic currents of different order should be added quadratically (root sum of squares).

The rated voltage of capacitors should be derived from the largest arithmetic sum of the power-frequency and individual harmonic voltages obtained from stress calculations in continuous operating conditions (Note: Maximum fundamental voltage and maximum harmonic contributions may not exist at the same time for STATCOM configurations including MSRs or MSCs).

For filter capacitor voltage rating, the loss of capacitor unit or elements should be considered up to the trip level.

The rated voltage of so-called "low voltage" capacitors (e.g. in double or triple tuned filters) should be chosen such as to also withstand imposed transient stresses from faults, energization, or other switching events.

A.6.3.3 Harmonic at PCC

The STATCOM Station's contribution to the harmonic distortion levels at the STATCOM Station connection point (PCC) to the transmission system shall not exceed the limits below.

Following are the maximum limits given using denominations according to IEEE STD 519-2019. The 2nd to the 60th harmonics should be considered.

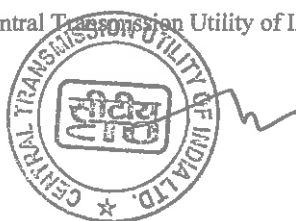

Transmission Service Agreement

Individual harmonics voltage distortion (Dn) < or = 0.5%

Total Harmonic voltage distortion factor (THD) < or = 1%

A.6.3.4 Harmonic calculation:

Chapter 7.3 of CIGRE Publication 139 together with information in PSSE network files given shall be used for the Network harmonic impedance.

A.6.4 MV Switchyard

- Medium Voltage (MV) delta bus shall be grounded through a Grounding Transformer (i.e. zig-zag winding Transformer) along with a suitable resistor in the neutral.
- MV Switchyard of different STATCOM Station branches shall be fenced with a fence height of meters. To minimize the probability of electrical fault suitable arrangement i.e. electrified fence shall be done to prevent the encroachment of unwanted animals or other to minimize the probability of electrical faults (Ph-E, Ph-Ph). Further bus bar arrangements shall be made in a way to minimize the probability of electrical faults.
- Secondary side of the Coupling Transformer shall be provided with suitable surge capacitors to mitigate transfer surges.
- For MV bus bar, an Aluminum conductor (Tube, Rectangular Hollow Section or C Section) may be used, however, a suitable bus bar end cover/cap shall be provided to avoid any animal/bird entering the hollow space.

A.6.5 Broadband Interference

A.6.5.1 Radio Interference

The TSP shall take necessary precautions in the form of shielding of valve hall and building or Containers to meet its own requirement together with any requirements that may be specified in Section-Project. Further, the following requirements shall also be met:

- a) With the STATCOM Station operating at any load upto rated value and within the design range of firing angle, the radio interference level from electromagnetic or electrostatic inductions generated by the STATCOM station shall not exceed 100 micro-volts/m, under fair weather conditions, at any point outside the station fence. The Radio Interference Level (RIL) criteria shall be achieved at all frequencies within the range of 150 kHz to 300 MHz and with the STATCOM operation at any level up to and including

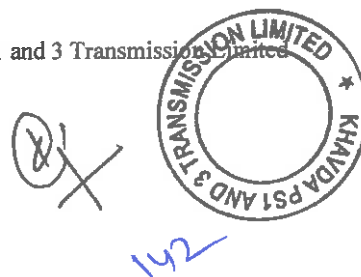
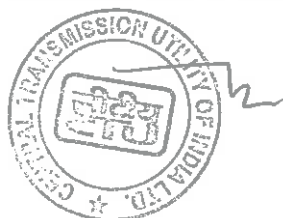

Transmission Service Agreement

rated value, the design shall provide correcting measures, should the specified design not being realized in the final installation.

- b) Measurements of actual RI at STATCOM Station shall be made by the TSP, at points along the above defined contour and at other critical points.
- c) RIV (Radio Interference voltage) measured at a phase to ground voltage (266 kV rms) in accordance to NEMA-107 shall not be more than 500 microvolts for 400 kV system. For other system voltages, IEC/NEMA in the order of preference shall be applicable.

A.6.5.2 Interference with Power Line carrier and open wire carrier system

The TSP shall take the necessary precautions in the form of noise suppression techniques and filtering devices to prevent harmful interferences from STATCOM Station to the power line carrier communication (PLCC) system operating on connected AC transmission network.

The frequency spectra to be protected are:

System	Frequency spectrum
Power Line carrier	30 kHz to 500 kHz
Open wire carrier	5 kHz to 30 kHz

A.6.6 Audible Noise

The TSP shall limit the audible noise in various areas of the STATCOM Station buildings and containers to the following values.

Valve hall (inside)	90 dBA
Mechanical equipment areas indoor (measured at 2 meter distance)	75 dBA
Mechanical equipment outdoor (Measured at 15 m distance)	75 dBA
Control Room Building*	60 dBA
At the limits of the STATCOM STATION perimeter fence	80 dBA

**This is the background noise from the ventilation system in adjacent rooms, control cubicles etc. Printers, recorders may be switched off during the measurement.*

A.6.7 Loss Requirements

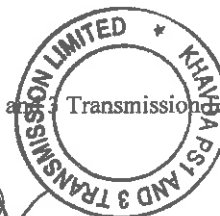
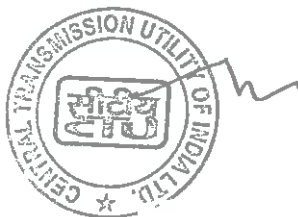

Transmission Service Agreement

- A.6.7.1** The TSP must guarantee the total losses of STATCOM Station will be less than 1% of the reactive power output individually at its inductive limit (STATCOM+MSRs) and capacitive limit (STATCOM+MSCs) for the cumulative highest reactive power output of STATCOM Station at PCC with the worse combination of manufacturing tolerances for the Option-1 to 4 as provided in clause A.3. In case of Option 5 as provided in clause A.3 i.e. +425/-550 MVAR STATCOM without MSC and MSR, the TSP must guarantee the total losses of STATCOM Station will be less than 1.5% of the reactive power output individually at its inductive limit and capacitive limit for the cumulative highest reactive power output of STATCOM Station at PCC with the worse combination of manufacturing tolerances. For the purpose of total loss measurements, it should be assumed that the ambient temperature is 20 °C, the PCC voltage is 1 per unit, and the slope setting is 1%. The STATCOM system may not operate under these conditions, but they provide a common base.
- A.6.7.2** The total losses shall include all components, as well as different parts or subsystems of the complete STATCOM Station such as coupling transformer, All VSC systems and components, MSC and MSR, Control and protection systems, including ancillary devices such as HMI, fault recorders, and SCADA, Auxiliary Power supply systems, cooling systems, Building ancillary services such as lighting, air conditioning, heating, and ventilation. It may be noted that for the redundant VSC valve levels and dual/redundant control and protection systems, the losses of redundant VSC valve levels and dual control and protection systems shall be considered during loss measurement.
- A.6.7.3** For the dual or redundant systems design of STATCOM Station, such as dual pumps or redundant fans, dual systems losses are to be excluded, if the dual system is not in service during the normal operation of the STATCOM Station. However, dual systems should be included if they are required to be in service under the defined operating conditions. The same methodology shall be applied for HVAC (heating ventilation and air conditioning systems).
- A.6.7.4** The TSP is required to prepare documentation for the detailed calculation of total losses based on measurement during Factory Acceptance Tests of major equipment and systems mentioned above as per relevant IS/IEC/IEEE standards and the same shall be preserved and to be submitted to CEA/CTU/GRID-INDIA, as per their requirement. Further for equipment/systems, whose loss measurement cannot be done during Factory Acceptance Test, the same can be measured at the site, and a combination of calculation and measurement shall be used to derive the total losses as specified above. During Loss measurement, all fans, and pumps; valve room and control room air-conditioning system shall be switched on. However, redundant fans, pumps and air-conditioners shall be kept off during loss measurement.

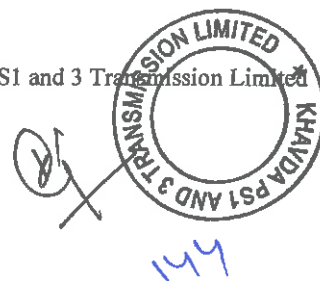

Transmission Service Agreement

A.6.7.5 During the factory tests the losses for the following equipment shall be measured/ assessed as detailed below:

Coupling transformer:

Losses shall be measured at factory/lab at the maximum rating, at power frequency as per relevant IEC/IS under below mentioned conditions:

- i. No load loss (Iron loss) at rated voltage and fundamental frequency.
- ii. Load loss (copper loss) at rating corresponding to maximum continuous current and at 75 °C.
- iii. Transformer cooling equipment's loss (Auxiliary loss) at rated voltage and fundamental frequency.

Reactors:

The losses shall be measured at the factory/lab at the maximum rating at power frequency as per relevant IEC/IS.

VSC Valves: Converter losses comprise the losses in power electronic switches [insulated gate bipolar transistor (IGBT) or equivalent], made up of conduction and switching losses, and the losses in DC capacitors, resistors, and inductors used within the converter system. Refer IEEE-1052 for calculating VSC losses.

Capacitor: The capacitor losses shall be measured at the manufacturer's works at power frequency as well as calculated to obtain the losses in the complete bank on the basis of factory measurement.

Auxiliary System:

Aux. power losses shall be calculated from the kW and efficiency of all motors (name plate rating) of the cooling system, air conditioning, ventilation etc. The higher of the total losses for the entire auxiliary systems occurring at full capacitive capacity MVAR or full Inductive MVAR as the case may be shall be considered for arriving at the total losses.

Harmonic Filters, if any:

The losses shall be calculated at the maximum STATCOM Station loading at 400 kV and 50 Hz.

The calculations shall be on the basis of the tested results of the components.

A.6.8 Selection of Insulation Levels

Central Transmission Utility of India Limited

101

Khayal PSI and 3 Transmission Limited

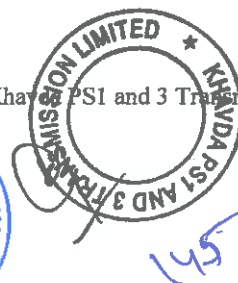

A.6.8.1 Arresters:

Protective levels of arresters connected to the 400 kV AC Bus Bars of the STATCOM Station shall be coordinated with the insulation and surge arrester Characteristics of the 400 kV AC systems to which the STATCOM Station is to be connected. The specification and characteristics of the surge arresters installed in 400 kV AC system is given in the Substation specifications. The front of wave (FWWL), lightning impulse (LIWL) and switching impulse withstand levels (SIWL) shall be determined by the following margins:

- a) A SIWL at least 1.15 times the switching impulse protection level.
- b) A LIWL which is an IEC standard level corresponding to the SIWL and shall be at least 1.25 times the lightning impulse protection level.
- c) A FWWL which is at least 1.25 times the front of wave protection level.

In addition to the above minimum basic requirement, the various insulation level of 400 kV equipment shall be as below. The STATCOM Station equipment, coupling transformers etc. shall be co-ordinated accordingly.

	SIWL	LIWL
All equipment including Transformer Bushing and winding	1050 kVp	1425 kVp

A.6.8.2 Valves

The requirement of insulation levels of the valves shall be as per the design requirement.

A.6.8.3 Air clearances

The air clearances shall be determined by the TSP based on the required withstand levels for all waveforms in order to limit the probability of flashover within the STATCOM Station to a target value of one flashover in 15 years.

A.6.8.4 Switchyard

The air clearances for switchyard equipment shall be equal to or greater than the minimum values as specified in IEC-60071. Altitude correction factor (if any) shall also be considered as per IEC.

A.6.8.5 Leakage distances

The Creepage/leakage distance across insulation shall be determined by the TSP and shall be adequate to ensure that under conditions of heavy pollution, the probability of a flashover of an insulator does not exceed one in 15 years.

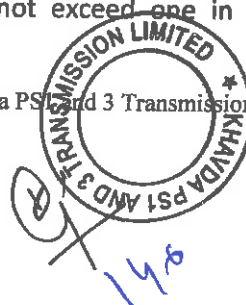
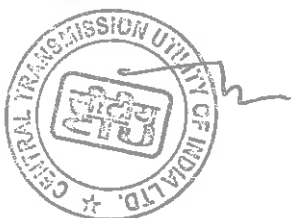

Transmission Service Agreement

However, the leakage distance for all AC insulators for outdoor installation shall not be less than 31 mm/kV of the maximum operating phase to earth rms voltage at the insulator. The leakage distance of equipment connected to 400 kV systems shall not be less than 13020 mm. Specific creepage distance for outdoor bushings, insulator strings and long rod insulators shall be a minimum 31 mm/kV.

A.6.9 STATCOM Station availability and reliability

The following definitions apply:

A.6.9.1 Outage terms:

a) Outage

The stage in which equipment is unavailable for normal operation due to an event directly related to the equipment which results in a reduction in STATCOM Station capacity.

b) Scheduled Outage

An outage that can be scheduled at least one week in advance

c) Forced outage

The stage in which the equipment is unavailable for normal operation but is not in the scheduled outage stage and which results in a reduction in STATCOM Station capacity i.e. an outage which is not scheduled outage.

A.6.9.2 Capacity terms

Maximum Continuous Capacity (Pm)

The maximum STATCOM Station capacity (MVAR) for which continuous operation under normal conditions is possible.

A.6.9.3 Outage duration terms

Actual outage duration (AOD)

The time elapsed in hours between the start and end of an outage.

A.6.9.4 Time Categories

- a) The number of hours in the reporting period in a full year, the period year is 8760 hours. If the equipment is commissioned, part way through a year, the period hours will be proportionately less than 8760 hours.
- b) Total Outage hour (TOH)

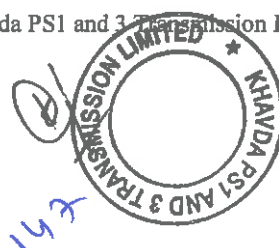
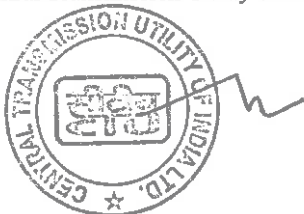

Transmission Service Agreement

The sum of all outage duration within the reporting period. TOH = AOD

A.6.9.5 Availability and Reliability Terms

Unavailability:

Unavailability is the duration for which the STATCOM Station is not available with a specified rating due to forced outages per year. If part of the station is unavailable, then the unavailability duration shall be counted proportionally. However, if STATCOM is out then its duration shall count as a fully unavailable STATCOM Station. However, if the STATCOM unit is out then the STATCOM Station unavailability shall be counted proportionally to STATCOM capacity. STATCOM Station Control system outage shall count as full STATCOM Station unavailability.

'OF' is the outage frequency which will be the number of forced outages per year.

The period basis for availability and reliability calculations shall be 12 months. The TSP shall ensure that the design will meet the specified guaranteed and design target value of availability and reliability.

Outage times for repair, maintenance and replacement of components shall be based on the premise that all items in the list of recommended spare parts are on hand, and that all maintenance schedules of recommended maintenance are adhered to. Reliability calculations shall be made and shall be presented as the expected frequency of unscheduled loss of STATCOM Station capacity. For simultaneous occurrence of events, for either of which a loss of capacity would result, the longer repair time shall be counted.

The facilities shall be assumed to be utilized 100% of the time at 100% load, regardless of the actual reactive power generated/absorbed by the STATCOM Station. Hence the availability and reliability assessment will be based on the capability of STATCOM Station to generate/absorb the rated reactive power regardless of whether, it is in service or not.

A.6.9.6 Availability Requirement

The calculated availability of the system considered on an annual basis shall be equal to or exceed the following target values.

Minimum availability requirement of each complete STATCOM Station

- Guaranteed for STATCOM Station - 98%

The outages of STATCOM Station capacity caused by the failure of equipment outside the scope of the TSP shall not be considered for the calculation of availability and reliability guarantee. However, such outages shall be restricted to

Central Transmission Utility of India Limited

104

Khavda PS1 and 3 Transmission Limited

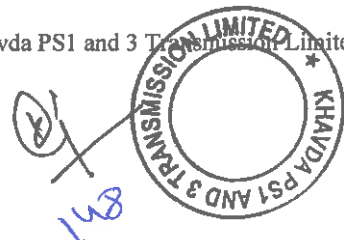
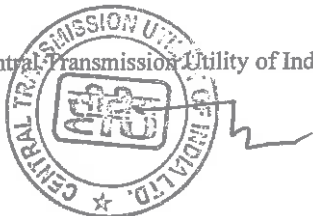

Transmission Service Agreement

- 1) Complete loss to 400 kV supply (at PCC)
- 2) Human Error.

Circumstances causing curtailment of STATCOM Station capacity that will be included in reliability and availability assessment and which can lead to forced outages shall include but not be limited to the following:

- a) Failure of equipment
- b) Mal-operation of control and protection system
- c) Failure to start
- d) Reduction in capacity.

A.6.9.7 Reliability Requirement

- a) Reliability

In the assessment of reliability, the following events shall also be considered to constitute a STATCOM Station outage:

- i) A STATCOM Station shut down.
- ii) A reduction of STATCOM Station capacity due to an outage of any component of STATCOM Station

The calculated reliability of the complete STATCOM Station shall be equal to or exceed the following design target values.

The average outage frequency per year for each STATCOM Station shall not exceed the following values:

	Design target for STATCOM Station	Max acceptable Guaranteed value for STATCOM Station
Total Number of Forced Outages	3 x Nos. of STATCOM Station	5 x Nos. of STATCOM Station

A.6.9.8 GUARANTEED FAILURE RATE OF Sub-modules. (Including all components and electronic). The maximum annual guaranteed failure rate of sub module (including all components and electronic) shall not exceed 1.0% per STATCOM. The failure rate shall not include failures directly attributable to operation and maintenance errors

A.6.9.9 GUARANTEED VALUE OF FAILURE RATE OF AC POWER CAPACITOR

The maximum guaranteed annual capacitor failure rate shall not exceed 0.15%

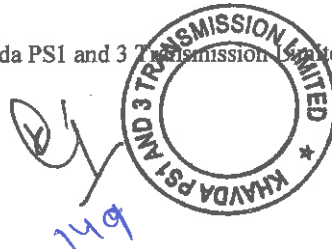
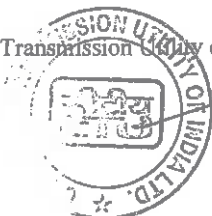

Transmission Service Agreement

except for first unit failure. The capacitor shall be considered as failed if its Capacitance value varies more than $\pm 5\%$ of the (actually measured) name plate value. Leakage of oil from the capacitor and the deformation of the capacitor unit shall be considered as a failure even if the capacitance value is within the tolerance limits.

A.7 Design Principles

The objective for the design of the STATCOM Station shall be to achieve a high level of availability and reliability as specified. Special attention shall be given to designing the STATCOM Station to avoid forced outages. The TSP shall conduct thorough design reviews to ensure the minimum risk of such outages. The TSP shall give careful attention to related factors affecting STATCOM Station performance such as subsystem and system testing, protective relays co-ordination and proper setting of relays.

Except where greater reliability requirements are specified in these specifications, the design basis for STATCOM Station shall be such that no single contingency downstream from the medium voltage bus shall cause a total outage of the STATCOM Station. The following general criteria shall be followed for the design of the control system:

- a) Use of components similar to those whose reliability has already been proved in use.
- b) Use of good design practices, surge protection, filtering, and interference buffers to assure Immunity to sensitive components and circuits against damage and interference by induced voltages and currents in the external cabling and cubicle wiring.
- c) Use of fail-safe and self-checking design features.
- d) Use of component and equipment redundancy, by means of either duplication or triplication with automatic transfer facilities wherever necessary to meet the requirement of these specifications.
- e) Design which in the event of component failures, provides for transfer to a less complex operating mode.
- f) Provision of alarm, fault diagnosis and indication

A.8 STATCOM Station Main Components

A.8.1 STATCOM Unit

The main electrical data of the STATCOM Units are the following:

Central Transmission Utility of India Limited

106

Khavda PS1 and 2 Transmission Limited



Transmission Service Agreement

- Rated voltage 20 kV Minimum
- Rated frequency 50 Hz
- Redundancy (Sub Module) 2 Nos. or 5% whichever is higher
- Rated Power of each STATCOM unit/Branch ± 50 MVAR Minimum
- Valve Cooling Deionized/Demineralized water

In general, the STATCOM units shall equally share the load however under contingency conditions it should be possible to run the units with unequal load. Charging of the DC capacitors of Sub module during the initial start-up shall be achieved by means of Resistors and bypass breaker arrangement. The charging resistor for DC capacitor of the STATCOM Sub module should be designed for three charges per hour followed by the appropriate cooling time. Power for the gate level control shall be derived internally from Sub module. The offered STATCOM Units with their Control system shall be suitably located inside the STATCOM Station Building.

A.8.1.1 STATCOM Valve

The valve shall be designed to meet the performance requirements described in this specification and as described below.

In order to ensure a modern low loss and reliable solution, the STATCOM valve assembly shall use the multi-module (including redundant sub-modules) approach.

The valves shall be designed to ensure satisfactory operation according to the overall performance requirements and include all necessary auxiliary equipment required for smooth and reliable operation. The valves shall be indoor air-insulated and cooled by de-mineralized water. The valves shall be of modular design and have removable Sub-Module for ease of maintenance. The valves shall be mounted to allow easy access for visual inspection, routine maintenance and replacement, and facilities shall be provided to enable easy access.

A.8.1.2 Semiconductor Switches

The electronic switches should be designed with the aim to achieve operation according to the overall performance requirements of the STATCOM Station. The valve shall be designed with individual semiconductor switches applied in a conservative manner with regard to their basic design parameters. The semiconductor switch shall meet the requirements of IEC 60747 except where otherwise specified herein.

The semiconductor switches shall be designed to withstand all stresses expected under steady state, transient and temporary overvoltage conditions. Basic

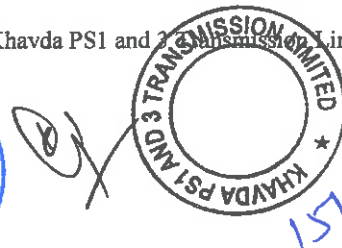
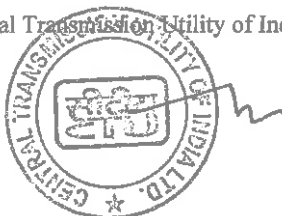

Transmission Service Agreement

semiconductor devices shall be of the Press Pack type, or packaged to provide short circuit means in case of device failure such that the STATCOM can continue to operate without interruption. The adjacent sub-module should be protected against the possible explosion of the semiconductor switch.

Under the restriction of redundancy (minimum two or 5% whichever is higher) i.e. the failure of any semiconductor switch or sub module or monitoring device etc shall not prevent continued system operation. In the event of any of the above failures, the STATCOM shall annunciate and identify the specific location of the failed device and continue operation until such time as repairs can be scheduled. During such time the next shutdown can be availed, the STATCOM must continue to operate without downgrading STATCOM capability.

The switching device's design should include an appropriate allowance for unequal voltage distribution across individual devices in the valve due to the stray capacitor and component tolerances.

The switching device's design should include an appropriate allowance for unequal voltage distribution across individual devices in the valve due to the stray capacitor and component tolerances.

Each switching device should be able to operate within component ratings, generally with at least two failed sub-module or levels. The number of possible failed sub-modules or levels as specified shall be consistent with the availability requirements of the STATCOM system.

A.8.1.3 Sub module for Multi-Module Topology

The key element of the multi-module topology shall be the sub-module. By increasing the number of these sub-modules, it is possible to obtain high voltage with extremely low harmonic distortion and very low dv/dt using a low switching frequency that reduces power losses. Sub-module shall have the following characteristics:

VSC sub-modules should be protected against over voltages with appropriate strategies. A description of the failure mode of the switching device and the strategies used for failure should be provided.

In each fiber optic cable (having multiple fiber cores) used for control/communication purposes of sub-module at least two fiber cores shall remain available as spare for future use.

A.8.1.4 The STATCOM sub-module has DC capacitors that require a charge to allow full functionality and performance. At the startup of the STATCOM Station, the



Transmission Service Agreement

capacitors are discharged. During the energization sequence of the STATCOM, Capacitors are charged from the main power grid via resistor operated in series to the main connection circuits. Once the desired charging voltages are reached, the charging resistor circuit is bypassed using a bypass switch/breaker.

The Type and Rating of the charging resistor and associated bypass switch shall be designed with the aim to achieve operation according to the overall performance requirements of the STATCOM Station and shall conform to the relevant Standard.

A.8.1.5 STATCOM Valve Cooling system

A closed-loop recirculating system shall be provided with full heat rejection capacity with redundancy for pumps, heat exchangers, and fans, appropriate to the STATCOM Station availability requirements. The cooling system should be able to maintain full capacity at maximum ambient temperature and maximum STATCOM reactive power output. The cooling system should be able to operate at the lowest ambient temperature and zero output specified. The Valve cooling system shall have black start capability and necessary UPS/UMD shall be provided separately for each STATCOM Unit.

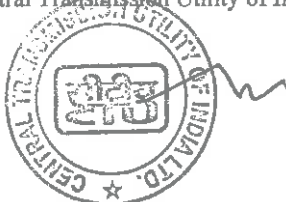

Transmission Service Agreement

The valve cooling system shall be designed to meet the performance requirements described in this specification and as described below.

- a) Each STATCOM Unit shall have its own de-ionized water valve cooling system with redundant pumps.
- b) For cooling the STATCOM valves, a deionized re-circulating (closed loop) water system shall be used.
- c) Water to air heat exchanger shall be used for cooling of this de-ionized water. Water to water heat exchanger shall not be employed.
- d) System shall be designed such that no shut down of STATCOM be resorted to for making up the deionized water in the system. The make-up water should comply with the recommended pH and purity.
- e) Cooling water shall have a constant flow rate irrespective of loading. The flow rate shall be decided on the basis of extreme operating conditions.
- f) The control system for the cooling system shall be redundant type including the provision of redundant control supply and main power supply. However, in place of the redundant control system for the cooling system, suitable alternate mode is also acceptable meeting the requirement of fulfilling cooling system operation even if failure of cooling control system.
- g) 2x100% pumps with one as standby shall be provided for the primary. Should a pump failure occur, the second pump should automatically switch in without shutting down the STATCOM. An alarm shall be displayed at the control panel for the failure of the first pump and standby pump in operation.
- h) Each cooling system shall be provided with an independent/dedicated UMD supply however common battery for both UMD power supply may be accepted. An UMD system will provide an extended capability of the STATCOM Station to deliver reactive power without any interruption, adding a buffer against the system faults or during events such as delayed voltage recovery or Transient over Voltage (TOV).
- i) The secondary cooling system shall be a redundant type such that it shall be possible to take out 10% (minimum one number) of the cooler module (fan unit) of secondary cooling system without affecting the rated performance of STATCOM).
- j) Normally no make-up water shall be required however in case of expansion

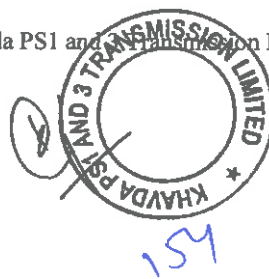
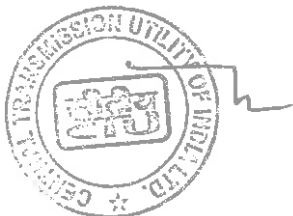

Transmission Service Agreement

vessel level going low; the same shall be replenished automatically by means the of make-up water tank and make up water pump to be supplied with the system.

- k) TSP shall provide a water treatment plant of sufficient capacity. The purification (treatment) system shall be designed to maintain conductivity below 1 micro Siemens. A resistivity cell in the outgoing water from the deionizer should detect the depletion of ionized material. Filters and deionizers shall be designed to allow replacement during operation. Normal replacement shall not be required more than once every year.
- l) Filters and deionizer/deoxidizer material shall be designed to allow replacement within minutes without shutdown of the cooling unit. (Normal replacement should not be required more than once/year).
- m) Primary cooling system shall monitor its own operation and condition of cooling water.
- n) The protection system of the cooling cycle shall have minimum following alarms:
 - i) Depleted deionizing cell
 - ii) Low water resistivity
 - iii) High water temperature
 - iv) Primary pump stopped
 - v) Fan stopped
 - vi) Primary pump or fan interlock circuits faulty
 - vii) Primary cycle (Make-up water) tank level low
 - viii) Failure of control supply.
 - ix) UMD/UPS fault.
- p) Following shutdown alarms / TRIP shall be provided with cooling system protection. Excessive low water resistivity Excessive high water temperature, complete loss of auxiliary supply to primary pumps, low flow, Low Pressure etc.
- q) The dissipative components of the converter are cooled with deionized water.
- r) The power losses are transferred to the external ambient by means of a deionized water /air heat exchanger. All the piping and other components Complete instrumentation set have been mounted on board in order to check the status of the cooling system:
 - Conductivity gauge system.

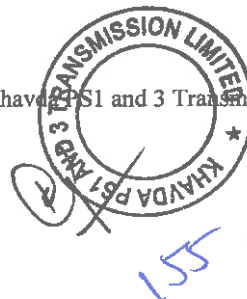
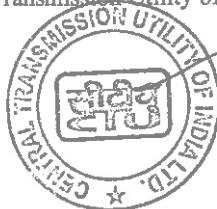

Transmission Service Agreement

- Flow meter equipped with two set points (alarm and trip).
 - Pressure meter
 - Two thermometers for the inlet and two thermometers for the outlet (two set points for alarm and trip)
 - Thermostat
- s) The status of the cooling system is monitored by means of the control system.
- t) Replacement of certain cooling equipment (e.g. pumps, fans, cooler unit etc.), if defective, should be possible while the cooling system still operates.

A.8.1.6 Tests on STATCOM Unit Valve

All applicable tests i.e. Operational Type Tests, Dielectric Type Tests and Test for valve insensitivity to electromagnetic disturbance and Production tests shall be done as per the latest edition of IEC 62927.

A.8.2 STATCOM Station Control equipment and operator interface

A.8.2.1 Control Equipment

The control systems should achieve the functional objectives given in 6.2. The accuracy of voltage should be within $\pm 1\%$ of the reference voltage. The accuracy of the gradient and linearity of the slope delivered by the STATCOM Station should be defined in relation to the current deviation from the theoretical slope defined in 3.1. The maximum deviation should be less than $\pm 5\%$ of the nominal current.

The control system design shall be based on a single fail criterion i.e. failure of any one component in the system should not result into outage of the complete system. As a minimum, a dual (hot standby) digital programmable controller shall be supplied for each STATCOM unit/branch and STATCOM Station to control the STATCOM, MSRs and MSCs completely including the functions listed as mentioned below:

- a. The controller shall have diagnostic and self-checking features for both itself and for valves, gate firing and drive circuits, interface hardware, and software. This is required to reduce outage times and to facilitate fault finding.
- b. The Controller shall be reprogrammable. The Owner shall have at least the following possibility for changing the following reference and limit values via HMI:

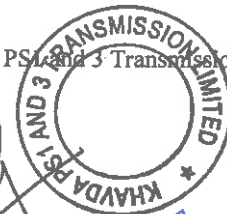
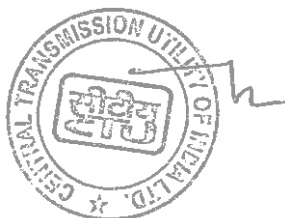

Transmission Service Agreement

c. Closed loop Controllers:

The STATCOM Station controller shall have the means to modify the reference set points. This refers to the functionality that will allow all the control parameters to be adjustable within selectable limits and is inclusive of, but not limited to following:

- o Voltage controller
- o Q controller (reactive power controller).
- o Supplementary VSC current controller.
- o Other supplementary control functions.

d. Sequence Controllers:

The sequence control and open-loop controllers shall include the control of all switchgears and associated control gear and external devices.

- e. The Controller shall have at least 10% excess I/O capacity to allow future program upgrades to satisfy the changing requirements of the power systems or future extensions to the STATCOM Stations. As a minimum, a control of up to 4 future HV shunt devices (reactors or capacitors) shall be included in the offer.
- f. All control signals available for remote control must also be available locally so as to ensure that a local operator can operate the STATCOM Station if the communications link between STATCOM Station and remote control centers is lost.
- g. A changeover switch shall be provided for control of the selection of local or remote control.
- h. TSP shall provide the equipment necessary for the purpose of control, protection and interlocking of allequipment within the scope of supply.
- i. TSP shall be responsible for the design and coordination of control, protection and interlocking system and switching sequences within the STATCOM Station. All necessary interfacing required between AC switchyard equipment and STATCOM Station for the above purpose shall also be included in the scope of TSP.
- j. It is proposed to control STATCOM through a Supervisory Control and Monitoring System (SCADA). All the data shall be acquired through suitable means from the field and various components and control is executed through the redundant HMI. The local STATCOM Station Control system

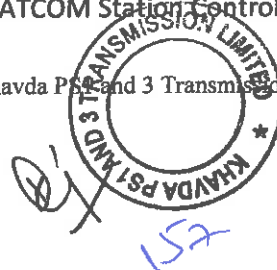
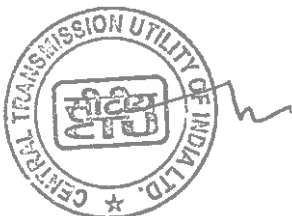

Transmission Service Agreement

shall consist of a redundant STATCOM Station controller, redundant HMI workstation, Gateway, STATCOM Station Control System Engineering cum Disturbance Recorder (DR), PC which can also be used as standby HMI workstations in case of emergency with associated peripheral equipment such as color laser log Printers, Color laser jet fault record printer, GPS System, Inverter / UPS etc. all interconnected via redundant Ethernet based Station LAN Network. Each work-stations and PCs at STATCOM Station shall have at least 19" LED display.

- k. In addition to the above, HMI workstation (identical to HMI Workstation provided in the STATCOM Station control room) should also be provided in the control room of the main 400 kV substation. This HMI workstation should be powered from an independent UPS system adequate enough to provide power to the HMI workstation for a minimum two hours in case of auxiliary power failure.
- l. The control equipment shall satisfy the reliability and availability requirements specified in this specification
- m. All necessary measures shall be taken to ensure satisfactory operation in the presence of harmonic current and voltage, noise and radio interference signals. The equipment shall be designed to operate in the environmental conditions specified in the specification.
- n. There should be a provision for independent operation of MSC/MSR after delinking it with STATCOM controls when STATCOM is out of service due to any reason.
- o. The threshold values for switching the MSC/MSR on/off shall be configurable in all modes of operation.

A.8.2.2 Operator Interface

- a) Each STATCOM Station shall have a SCADA consisting of an HMI which shall provide a Centralized (local) operator control of the STATCOM Station functions. All human interface operations necessary for the control and monitoring of the STATCOM shall be provided at this point.
- b) Any abnormal condition requiring operator action or intervention or maintenance on any of the STATCOM Station subsystems shall be annunciated at the STATCOM Station control room and the Substation control room.

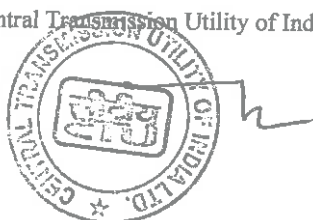

Transmission Service Agreement

- c) The local HMI shall include the following diagrams as different screens in the display system:
- i. Complete STATCOM Units and STATCOM Station single line diagram including EHV and MV busses
 - ii. AC Auxiliary supply and distribution
 - iii. DC Auxiliary supply and distribution
 - iv. STATCOM Valve cooling systems
 - v. Interlocking system.
- d) These diagrams shall indicate status, alarms, voltages, currents, etc. The HMI shall provide complete diagnostics on alarm and trip indications as required and discussed in this specification, including SER information.
- e) A facility shall be provided whereby the local HMI features and functions shall be accessible from remote. A remote user shall be able to view screens and change STATCOM Station parameter settings.
- f) As KPS-1 and KPS-3 substations where STATCOM Station shall be installed, will be equipped with Sub-station Automation System (SAS) conforming to IEC 61850, it is required that STATCOM Station control and monitoring shall be integrated with SAS already provided at the main 400 kV Sub-station by the TSP. It is proposed to connect STATCOM Station's SCADA with SAS through a Gateway and the database, configuration etc of the main substation SAS shall be upgraded to incorporate STATCOM Station events, alarms, Controls (both switchgear and control functions of STATCOM Station like the setting of parameters etc.) so that STATCOM Station can be effectively monitored and controlled from main substation SAS and shall be monitored from Load Dispatch Center (WRLDC).

A.8.3 STATCOM Station Protection System

A.8.3.1 Protection system Design

- a) To ensure that faults are cleared within stability critical clearing time, to minimize damage to the plant, and to avoid voltage collapse, loss of load, or load limitations, TSP shall provide a high speed main protection scheme. An independent (having a separate measurement system) back-up protection scheme shall be provided in the event of the main protection scheme failing or taken out for maintenance.

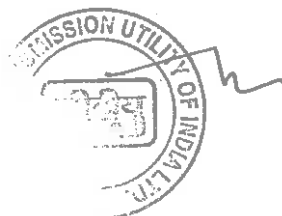

Transmission Service Agreement

- b) The STATCOM Station shall be completely self-protecting (unit protection). STATCOM Station shall be protected from damage for all conditions of over-current, overvoltage, excessive reactive power loading, unbalance due to loss of capacitor elements, phase-to-phase and phase-to-ground faults, three phase faults, loss of cooling, semiconductor valve or control malfunction, faults (STATCOM, MV system) in individual primary connected components of the STATCOM, HV system faults, etc. The STATCOM Station shall withstand the maximum fault current for a period of the maximum fault clearing time as specified, considering second contingency cases due to the previously mentioned conditions.
- c) All protection equipment and systems should be properly co-ordinated to prevent incorrect operations of the protection equipment or systems during normal STATCOM Station operation, including anticipated abnormal conditions on the transmission system, as specified. Fail-safe principles should be applied throughout.

A.8.3.2 The basic principle and order of precedence for the control and protection shall be, to take care of the following:

- Correctly identify a fault, problem or error condition,
 - Only if necessary, isolate the minimum number of components, subsystems whenever possible,
 - Utilize degraded modes to the maximum extent possible either directly (no interruption of the STATCOM Station operation) or indirectly (by tripping the STATCOM Station momentarily in order to isolate the branch and re-energization of the STATCOM Station).
 - Trip STATCOM Station and Block.
- a) Failure of the STATCOM Station Interface (SCADA interface) shall not result in a Protection trip of the STATCOM Station. A fail-safe philosophy shall be implemented to allow the STATCOM Station to operate safely and independently from the STATCOM Station Interface (SCADA interface).
- b) Protection equipment shall be designed and applied to provide maximum discrimination between faulty and healthy circuits.
- c) The Protection shall be sufficiently sensitive to cater to the full range from maximum to minimum fault level conditions. The Protection shall also be suitable for a system fault level equal to the maximum short circuit capacity of the substation. All current transformer designs shall be based



Transmission Service Agreement

on these fault levels.

- d) All required protective, control devices, etc including auxiliary instrument transformers and panels, relays, cabling, wiring, indication, and all other associated plant and material necessary for the effective operation of the protection systems shall be supplied and installed by TSP.
- e) The protective relays shall be microprocessor based. Relays shall have approved characteristics and be mounted in dust and moisture-proof cases. The protective relays shall be provided with visual indications for starting, tripping and failure of the protective function. The LEDs shall be reset without opening the covers. The protection relays shall also be equipped with HMI facilities suitable for manual parameter settings and viewing of the settings. Relays with provision for manual operation from outside the case, other than for resetting, are not acceptable. Relay settings shall be visible and readable without having to remove the relay cover. Relays shall be of approved construction and shall be arranged so that adjustments, testing and replacement can be effected with the minimum of time and labor. Auxiliary Relays of the hand reset type, if provided shall be capable of being reset without opening the case. Electrically reset tripping relays shall be provided as necessitated by the system of control, such as for those circuits subject to remote supervisory control.
- f) Relay contacts shall be suitable for making and breaking the maximum currents which, they may be required to control in normal service but where contacts of the protective relays are unable to deal directly with the tripping currents, approved Auxiliary tripping relays shall be provided. In such cases, the number of auxiliary tripping relays operating in tandem shall be kept to a minimum in order to achieve fast and reliable fault clearance times. Separate contacts shall be provided for alarm and tripping functions. Relay contacts shall make firmly without bounce and the whole of the relay mechanisms shall be as far as possible unaffected by vibration or external magnetic fields
- g) Steps shall be taken to protect the circuitry from externally impressed transient voltages which could reach the circuitry via connections to instrument transformers or the station battery. The routing of cables should be such as to limit interference to a minimum. Any auxiliary

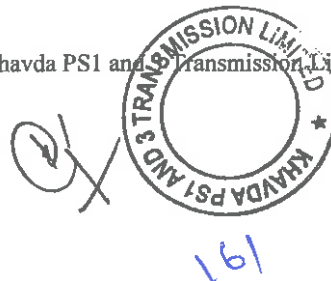
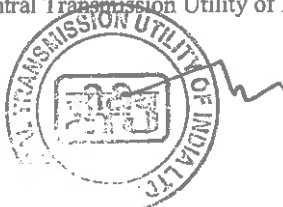

Transmission Service Agreement

supplies necessary to power solid-state circuits shall be derived from the main station battery and not from batteries internal to the protection.

h) Relay communication

The Relays shall also have a communication port provided on the front of the relay for configuration and parameter settings as well as downloading of data. A direct port suitable for remote communication shall also be provided at the back of the Relay. This port shall conform to IEC - 61850.

i) Tripping schemes

- Tripping of MV circuit breakers shall be done by means of two-separated trip signals.
- Duplicate high security tripping circuits for MV Circuit Breaker shall comprise two independent high speed (less than 10 ms) high burden (greater than 150 W) tripping relays for each circuit, each with its own independent DC supply. The trip circuits for all circuit breakers need to be equipped with a "lockout" function and it shall be possible for this to be reset manually and remotely by the operator.

j) The protection for the power system is based on a normal switching state and an occurrence of a single fault. This means that faults resulting from maintenance as well as the simultaneous occurrence of two or more faults are not taken into account.

k) The input circuits of the digital protections shall be monitored by means of a plausibility check. If any incorrect information is found, the protection function shall be blocked by the protection system. All protection relays shall have facilities for monitoring trip circuits. Detection of an interruption in the case of a switched on circuit breaker shall be signaled.

l) Test facilities

- It shall be possible to test the protective device during operation without causing trips. Links shall be provided for the isolation of individual protection trip circuits and the common protection trip circuit to each circuit breaker trip coil.
- Separate test facilities shall be provided for each current and voltage transformer secondary circuit so as to give access for testing of protection relays and associated circuits. The Test facility to be supplied

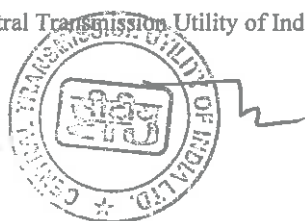

Transmission Service Agreement

shall have two selectable positions, a Service and a Test position. In the service Position, the test switch connects CTs and VTs signals to the Relays and trip commands to the circuit breaker trip coils. In the Test Position, the test switch applies a short-circuit to the Current Transformer (CT) secondary windings and open circuits the VT secondary cores and allow injection of secondary current and voltage into the relay. At the same time, the Trip commands to the Circuit Breaker Trip Coils are isolated. The test switch supplied shall be to the Approval of the Owner.

- m) The protection of the electrical system shall be designed and installed in such a way that the failed equipment is disconnected selectively and automatically. All equipment have to remain operative during transient phenomena, which may arise during switching or other disturbances to the system.
- n) **Auxiliary DC Supplies**
- The protection concept has to be designed in a way so that back-up protection is provided at all times. All protection relays shall be configured in a way that failure of one Auxiliary DC system will not affect the relay. If all DC supplies to the controllers are lost, the STATCOM Station breaker must be tripped via the protection panel.
- o) **Electromagnetic Compatibility**
- Electronic Relays and other electronic devices and the ancillary circuits connected to them, such as power supplies, current and voltage transformer secondaries, status or tripping or alarm circuits shall be designed to ensure that they are compatible for use in the hostile electrical environment found in an MV or HV substation.
 - Adequate steps by means of suitable design, shall be taken to prevent Electromagnetic Interference (EMI), (generated by sources such as circuit breakers, disconnectors, lightning, radio or radar emissions, switching contactors in DC circuits etc) or Electrostatic Discharges (ESD) from affecting relay performance or causing damage to components.
 - All relays offered shall therefore have been type-tested to meet the current requirements of IEC Standards with respect to High Frequency disturbance, Fast Transients, Electrostatic Discharge, Radio Frequency Interference testing etc.
- p) **List of Protection functions for STATCOM Station**

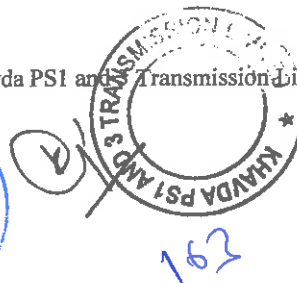
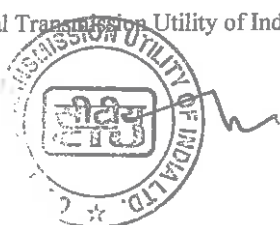

Transmission Service Agreement

Coupling Transformer Protection:

- i) Biased Differential protection (87T)
- ii) REF protection (64T)
- iii) Overcurrent protection (50, 51)
- iv) Ground Overcurrent (51N)
- v) Over flux protection (HV and MV)
- vi) Transformer mechanical trips

STATCOM MV Bus Protection:

- i) Bus Differential protection (87)
- ii) Ground over current protection (51N), used with a neutral Grounding Transformer
- iii) Under / Over Voltage (59 Ph-Ph) protection
- iv) Over voltage (Open Delta) protection

STATCOM Branch Protection:

- i) Differential protection (87)
- ii) Overload protection (49)
- iii) Overcurrent protection inside delta (50, 51)
- iv) Negative phase sequence protection (46)
- v) STATCOM branch overcurrent protection (50, 51, 50N, 51N)

MSR Branch Protection:

- i) Differential protection (87)
- ii) Ground over current protection (51N)
- iii) Reactor branch unbalance protection (Negative Phase Sequence)
- iv) Thermal Overload protection

MSC Branch Protection:

- i) Ground over current protection (51N)
- ii) Capacitor Overvoltage (Using current signal) protection.
- iii) Capacitor unbalance protection (60C)
- iv) Over current protection (50, 51)

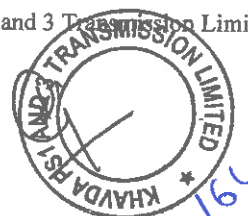
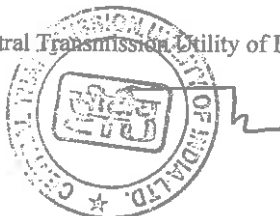

Transmission Service Agreement

- The protection functions listed above are the minimum set of function to be provided, any additional protection required to fulfill the requirement of the protection system shall also be provided.
- Further protection functions of individual branch (STATCOM, MSC, MSR) shall trip the respective branch MV CB (Circuit Breaker).
- All CBs shall be provided with individual Breaker Failure protection relays. Breaker Failure relay shall have the logic based on the current signal or CB close open status.
- Any fault on MV bus will trip the 400 kV breaker. However, any branch fault shall be cleared by the respective MV branch Circuit Breaker.
- Protection System for the STATCOM valve portion of the STATCOM station shall be provided in the redundant controllers to isolate the STACOM valve during internal overload/overvoltage, ground fault etc.

A.8.4 STATCOM Station Fault Recording System

An integrated Transient Fault Recording (TFR) System shall be supplied, installed and commissioned. This shall include trigger level settings for analog signal, etc subject to review and comment. Disturbance and event recording facilities are required for local monitoring of the STATCOM following a disturbance on the power system or the STATCOM System. The TFR shall be GPS synchronized. The following inputs are required:

- All analog signals (output signals) including 3-ph & sequence values of voltage, current.
- All digital signals (control outputs, status indications, commands, alarms, and trip indications). Internal STATCOM Station control signals/variables to be selectable.
- The accuracy of the TFR for event inputs shall be at least 100 μ s (sampling rate of minimum 10 kHz).
- The TFR shall have provision for remote access and retrieval of recorded information onto a PC. For this purpose, a communication link to the substation LAN shall be implemented.
- The remote software application for data retrieval shall be included.
- There shall be multiple channels to view 3-ph and sequence values of voltage, current.
- TFR file shall be viewable in any open source software.

A.8.5 Mechanically Switched Reactor (MSR)

MSR is a fixed source of inductive reactive power connected in shunt to the MV bus of STATCOM Station and switched by means of a circuit breaker (with a control switching device) based on the command from the STATCOM Station control system. The rated capability of MSRs shall be at 400 kV (Referred to as "Point of

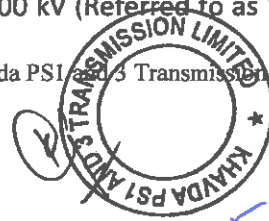
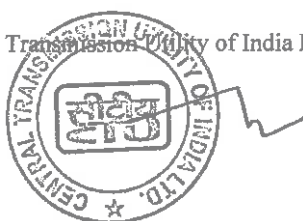

Transmission Service Agreement

Common Coupling" or PCC) and in the steady state frequency range of 48.5 Hz-50.5 Hz. However, The MSR Components shall be designed with the aim to achieve operation according to the overall performance requirements of the STATCOM Station. The individual components of MSR shall be able to withstand the onerous conditions imposed by system overvoltage and harmonics. The MSR consists of 3-ph Air Core Reactor, 3-ph MV Circuit breaker (SF6/Vacuum type), associated current transformer, 3-ph Disconnecter and associated safety grounding switch. The MSR area shall be fenced and a castle key interlock with safety grounding switch shall be provided for human safety.

Specifications for individual components like Air core reactors etc are provided in the subsequent clause.

A.8.6 Mechanically switched capacitor (MSC)

MSC is a switched 3-phase capacitor bank connected in shunt to the MV bus of STATCOM station and switched automatically by means of a circuit breaker (with control switching device) based on the command from STATCOM Station control system. The rated capability of MSCs shall be at 400 kV (Referred to as "Point of Common Coupling" or PCC) and in the steady state frequency range of 48.5 Hz-50.5 Hz. However, TSP will ensure the corresponding values at PCC (400 kV) for possible operating condition measured at PCC. The MSC Components shall be designed with the aim to achieve operation according to the overall performance requirements of the STATCOM Station. The individual components of MSC shall be able to withstand the onerous conditions imposed by system overvoltages and harmonics. The MSC consists of 3-ph AC power capacitor bank, a current limiting air core reactor as required, 3-ph MV Circuit breaker (SF6/Vacuum type), associated current transformer, 3-ph Disconnecter and associated safety grounding switch. The MSC area shall be fenced and a castle key interlock with safety grounding switch shall be provided for human safety. Specifications for individual components like Capacitors, Air core reactors etc are provided in the subsequent clauses.

A.8.7 Air Core Reactors

- a) Reactors shall be air core, dry type, be suitable for outdoor installation and there shall be no tapping on the reactors. The insulation level shall be adequate and TSP has to ensure proper insulation coordination.
- b) The insulation of the reactor shall be class F and hot spot temperature rise shall not exceed 105 °C above ambient temperature. Winding temperature rise shall not exceed 80 °C above ambient temperature.

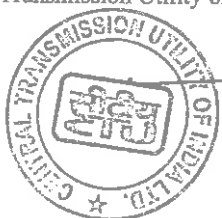

Transmission Service Agreement

- c) The reactor shall be designed to withstand thermal dynamic shocks and mechanical shocks while in service and during erection.
- d) The reactor shall fully conform to the relevant IEC standard.
- e) The reactor shall be designed to withstand overloading due to over voltage as specified and shall also be subjected to excitation by harmonics; the reactor must be able to withstand such events without deterioration in normal life.
- f) The reactors shall be subjected to type and routine tests in accordance with the latest issue of IEC-60076 as appropriate to the type of reactor provided.
- g) Tests on Reactors: The reactors shall be subjected to type and routine tests in accordance with the latest issue of IEC-60076 as appropriate to the type of reactor provided.

A.8.8 AC POWER CAPACITORS

i) General

- a) The capacitor banks shall comprise capacitor units, discharge devices, protection equipment, series reactor as required, earthing switches, suitably connected in series and parallel, mounted at ground level with protected fencing all around. The number, arrangement and connection of capacitor banks shall be designed to suit the requirement of the compensator as a whole. If convenient, the capacitor banks may be used in conjunction with reactors. In this event, the rating of the capacitor shall be adequate to cope up with the harmonic loading. The frequency variations shall also be considered. To limit the peak inrush current for switching in the capacitors, current limiting reactors with parallel connected damping resistors, if required shall be connected in series with shunt capacitor banks.
- b) The capacitors shall be provided with internal-type fuses. Alternatively, the fuseless capacitor is also acceptable.
- c) Fuses shall not melt nor shall deteriorate when subjected to the inrush current during the life of the capacitor bank.
- d) With the capacitor charged to a peak voltage, the fuses associated with the healthy elements shall not melt when carrying the discharge current resulting from a breakdown of an element or from an external short circuit.

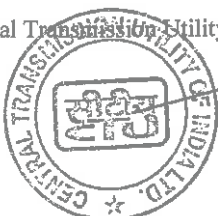

[Handwritten signature]
187

Transmission Service Agreement

- e) Fuses shall be capable of disconnecting a faulty element over a range of voltage across the unit terminals from $0.9 U_n$ to $2.0 U_n$. In addition, if all the elements in the same row of an internally fused capacitor were to fail as a result of a cascading action, the last fuse element to melt shall be capable of successful disconnection with a voltage of not less than 1.5 times.
- f) After fuse operation the fuse assembly shall be able to withstand continuously at least 1.5 times the rated unit voltage U_n across the gap for 10 Seconds.
- g) Fuses shall preferably be of the current limiting type but fuse system shall in any event be designed to ensure that energy released into a faulty capacitor unit is less than the value that will cause rupture or bursting of the container.
- h) The capacitor units shall be the outdoor type. The container of the capacitor shall be of stainless steel.
- i) Each capacitor unit shall be readily accessible and replaceable without disturbing any other unit. The supporting frames shall be designed to provide adequate ventilation to the units.
- j) The dielectric fluid used in the capacitor unit shall be environmentally safe and bio-degradable, non-toxic. Polychlorinated biphenyle (PCB) type dielectric or any of its derivatives shall not be acceptable.
- ii) Construction and Design Requirement**
- a) The capacitors shall conform to IEC-60871. The capacitors shall be provided with internally mounted discharge resistors with characteristics in accordance with IEC-60871.
- b) The current limiting reactors (as required) shall be dry type and connected in series with the capacitor bank. Suitable lifting lugs shall be provided.
- c) The capacitor enclosure shall have sufficient strength to withstand without damage or loss of life, mechanical load, both in operation and during erection. The loads shall include electromagnetic forces including those during faults external or internal to the capacitor bank, wind loading, forces due to expansion and contraction caused by ambient temperature and load variation, and seismic effects all as specified.
- d) The capacitor units shall be interchangeable in order to reduce the spare requirements and simplify maintenance procedures.

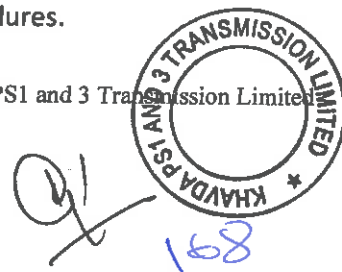
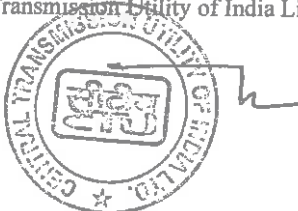

Transmission Service Agreement

- e) The capacitor stack shall be vibration free. The stack shall have a fixed potential, that is connected to one electrical point in the bank. The stack shall be of galvanized structural steel.
- f) The capacitor racks shall be supplied complete with all capacitor units, insulators, and connections and shall be equipped with lifting lugs/eyes to facilitate assembly into the stacks. The racks shall be constructed of galvanized structural steel. No drilling of galvanized steel shall be allowed. Each rack shall be labeled with the weight of the fully equipped racks, the phase, and the bank of which it forms a part. The maximum and minimum capacitor unit capacitance which may be substituted into the racks as spares shall be suitably identified. Suitable warning labels shall be affixed.
- g) The capacitor shall be specially designed to be suitable for intermittent duty.
- h) The capacitors should comply with the overload capacity as per NEMA Standard.
- i) The capacitor elements shall be vacuum dried inside the case prior to impregnation with dielectric fluid. After impregnation, the capacitor unit shall be sealed immediately upon removal of the impregnated reservoir.
- j) The discharge resister shall discharge the unit from peak operating voltage to less than 75 Volts within 10 minutes.
- k) The capacitor case shall be made from type 409 stainless steel or equivalent stainless steel with all joints welded and tested for leaks.
- l) All racks and bus insulators as well as the insulators used to insulate each stack of capacitor from ground level shall be pincap or post type. The minimum voltage rating shall be 15 kV and low frequency wet withstand voltage of all insulators used to insulate within or between the capacitor rack of a stack shall not be less than three times the actual voltage stress across the insulators. The insulator shall be outdoor type manufactured from wet porcelain. The insulators shall be bolted to the top members of the frame to support electric-grade aluminum buses.
- m) The size and groupings of the individual capacitor units shall be such that a single blown fuse will not cause the voltage across the parallel group to rise by more than 10%.
- n) The redundancy to be provided, shall be as per the requirement specified regarding reliability and availability in the clause mentioned elsewhere.

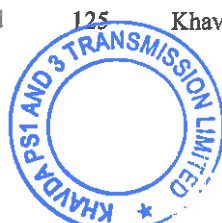

Handwritten signature or initials.

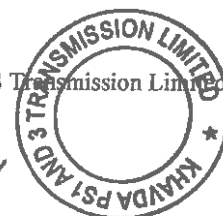

Handwritten number 169.

iii) Capacitor Unit Failure Detection

The stages of capacitor units or element failure detection shall be provided as below:

- a) A three-step unbalanced current protection shall be provided in each capacitor bank to initially generate an alarm when the unbalance limit is reached and finally to trip the bank in case of the limit is exceeded.
- b) The first stage shall generate an alarm and the capacitor unit shall continue in service. It may be assumed that the bank shall be disconnected for maintenance within 2 weeks.
- c) The second stage shall generate a separate alarm and a delayed trip signal which will disconnect the bank after two hours.
- d) The third stage shall cause immediate disconnection of the Capacitor Bank.

iv) Tests on Capacitors

All the tests on capacitor units shall be in accordance with the latest issue of IEC 60871.

A.8.9 Coupling Transformer

The TSP shall provide single-phase coupling transformers to operate as 3- phase bank with one unit as a common spare (cold spare) with necessary auxiliary arrangements for stepping down the voltage from 400 kV system to a suitable medium voltage value as required for replacing any one of the faulty phase units without physically shifting the transformer. The Medium Voltage side of the coupling transformer to couple with the STATCOM shall not be less than 20 k to ensure optimum power transformation.

The Coupling Transformer shall be designed with the aim to achieve operation according to the overall performance requirements of the STATCOM Station. The transformer should be designed and rated to carry complete capacitive and inductive reactive loading as specified for STATCOM Station including that of mechanically switched capacitors and Reactors etc.), as well as harmonic currents associated with the most onerous operating conditions of STATCOM Station, without loss of life.

The coupling transformer shall be designed in accordance with the most up-to-date experience in STATCOM application and shall incorporate the latest improvements of design currently employed in the industry. The Comprehensive

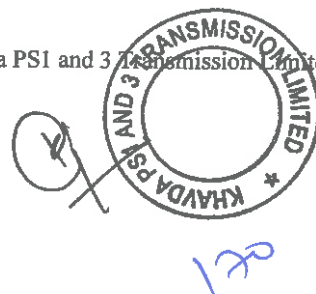
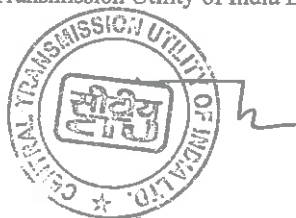

Transmission Service Agreement

design review of the Coupling Transformer of STATCOM Station shall be carried out by the TSP.

A.8.9.1 General Requirements

The coupling transformer shall be designed electrically and mechanically for operating conditions peculiar to STATCOM Station operation, which shall include, but not be limited to the following:

- a) Electrical insulation problems resulting from the transformer being subjected to voltages of distorted sinusoidal wave shape because of saturation, harmonics, trapped charges in capacitors etc.
- b) The cumulative effect of electro-dynamic forces produced during valve commutation or other short circuit conditions imposed by valve design limitation and valve group operation.
- c) Harmonic currents due to STATCOM operation, with reference to additional stray losses resulting from these harmonic currents.
- d) No generation of uncharacteristic harmonics by the transformers.
- e) Stresses due to normal control operation and other onerous operations such as blocking and de-blocking.
- f) Stress due to the fast response requirement of STATCOM for loading from 100% inductive to 100% capacitive and vice-versa.
- g) Overvoltage stresses for which STATCOM shall be designed as per specification would apply to the transformer also.
- h) All other stresses for which STATCOM Station shall be designed as per specification would apply to the transformer also.
- i) The transformer and all its accessories like Bushings, CTs etc shall be designed to withstand without damage, the thermal and mechanical effects of any external short circuit to earth and of a short circuit across the terminals of any winding for a period of 3 seconds. The short circuit level of the 400 kV system to which the transformer shall be connected, will be as per the maximum short circuit level of the main substation. Short Circuit level of the Coupling Transformer shall be as per the Short Circuit level of the respective Substation. Short circuit level for HV bushing shall be 63 kA for 1 Sec.
- j) The transformer shall be capable of being loaded in accordance with IEC 60076 or the overload conditions as specified whichever is the worst. There

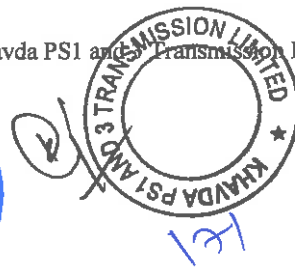
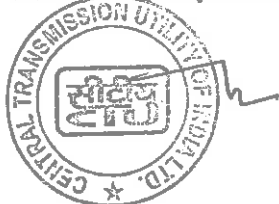

Transmission Service Agreement

shall be no limitation imposed by bushings during its terminal fault.

- k) The transformer shall be capable of withstanding the mechanical stresses caused by symmetrical or asymmetrical faults on any winding.
- l) The transformer should be designed to carry a certain level of direct current consistent with the STATCOM design. To ensure minimum harmonics generation, the saturation flux density of the transformer should be higher than the maximum flux density reached over the full steady state (continuous operating) range; this margin shall be at least 10%. This maximum flux density (over the full steady-state range) is obtained at the highest secondary voltage during any reactive power generation, highest reference voltage, minimum slope, and minimum continuous frequency. The flux density at the highest secondary voltage shall lie in the linear portion of the BH curve of the core. Any harmonic generated by the transformer should be considered for the design of the STATCOM.
- m) All protection class Current Transformers in the coupling transformer shall be of PX/PS type. Other details of these Current Transformers shall be as per protection/metering requirements and shall be decided during detailed engineering. However, the parameters of the Winding Temperature Indicator (WTI) of Current Transformer for each winding shall be as per the Coupling Transformer manufacturer.
- n) Transformers shall be capable of operating under natural cooled conditions up to the specified load. The forced cooling equipment shall come into operation by pre-set contacts of winding temperature indicator and the transformer shall operate as a forced cooling unit initially as Oil Natural Air Forced (ONAF) up to a specified load and then as Oil Forced Air Forced (OFAF). Cooling shall be so designed that during total failure of power supply to cooling fans and oil pumps, the transformer shall be able to operate at full load for at least ten (10) minutes without the calculated winding hot spot temperature exceeding 140 degree Celcius. Transformers fitted with two coolers, each capable of dissipating 50 percent of the heat due to losses at the continuous maximum rating, shall be capable of operating for 20 minutes in the event of failure of the oil circulating pump or blowers associated with one cooler without the calculated winding hot spot temperature exceeding 140 degree Celcius at continuous maximum rating.
- o) The transformer shall be free from any electrostatic charging tendency (ECT) under all operating conditions when all oil circulation systems are in

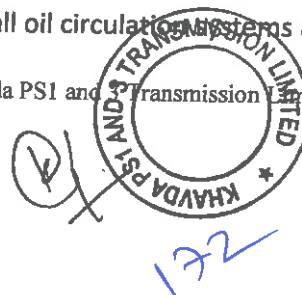
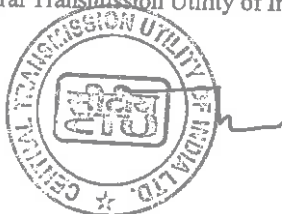

Transmission Service Agreement
 operation. In general, the oil flow speed shall not exceed 1.0 m/sec within winding in the oil flow system of the transformers. The manufacturer shall ensure that there is no electrostatic charging tendency in the design.

The Technical Parameters of the Transformer shall be as below

Sl. No.	Description	Unit	Technical Parameters
1.1	Rated Capacity		
	HV	MVA	To meet the performance requirement & ratings of STATCOM. The transformer shall be suitable for 100% reactive loading
	MV	MVA	
1.2	Voltage ratio (Line to Line)		400 / XX (*)
1.3	Single / Three Phase Design		Single phase
1.4	Applicable Standard		IEC 60076
1.5	Rated Frequency	Hz	50
1.6	Cooling and Percentage Rating at different coolings		ONAN/ONAF/(OFAF or ODAF): 60% / 80%/100% OR ONAN/ONAF1/ONAF2: 60% /80%/100% OR OFAF (with 5 x 25% unit cooler if required)
1.7	Impedance at 75 °C (in percentage)		
	HV-MV		To suit the design requirements.
1.8	Tolerance on Impedance (HV-MV)	%	As per IEC
1.9	Service		Outdoor
1.10	Duty		Continuous Reactive loading
1.11	Overload Capacity		IEC-60076-7
1.12	Temperature rise over 50 °C ambient Temp		
i)	Top oil measured by thermometer	°C	50
ii)	Average winding measured by resistance Method	°C	55
1.13	Windings		

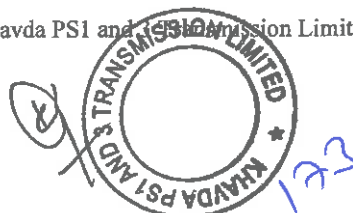
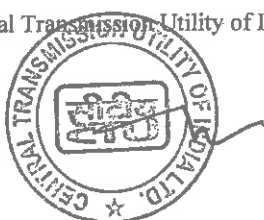

Transmission Service Agreement

Sl. No.	Description	Unit	Technical Parameters
i)	System Fault level		
	HV	kA	63
	MV	kA	To suit the design requirements.
ii)	Lightning Impulse withstand Voltage		
	HV	kVp	1300
	MV	kVp	*
	Neutral	kVp	170
iii)	Switching Impulse withstand Voltage		
	HV	kVp	1050
iv)	One Minute Power Frequency withstand Voltage		
	HV	kVrms	570
	MV	kVrms	*
	Neutral	kVrms	70
v)	Neutral Grounding		Solidly grounded
vi)	Insulation		
	HV		Graded
	MV		Uniform
vii)	Tan delta of winding	%	< 0.5
1.14	Vector Group (3 – ph) (unless specified differently elsewhere)		Ynd*
1.15	Tap Changer		Not Applicable
1.16	Bushing		
i)	Rated voltage		
	HV	kV	420
	MV	kV	*
	Neutral	kV	36
ii)	Rated current (Min.)		
	HV	A	*
	MV	A	*
	Neutral	A	*
iii)	Lightning Impulse withstand Voltage		
	HV	kVp	1425

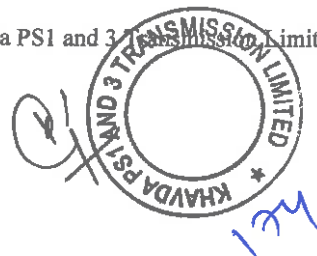

Transmission Service Agreement

Sl. No.	Description	Unit	Technical Parameters
	MV	kVp	*
	Neutral	kVp	170
iv)	Switching Impulse withstand Voltage		
	HV	kVp	1050
v)	One Minute Power Frequency withstand Voltage		
	HV	kVrms	695
	MV	kVrms	*
	Neutral	kVrms	77
vi)	Minimum total creepage distances		
	HV	mm/kV	31
	MV	mm/kV	31
	Neutral	mm/kV	31
vii)	Tan delta of bushings		
	HV	%	Refer Note 2
	MV	%	Refer Note 2
viii)	Max Partial discharge level at Um		
	HV	pC	10
	MV	pC	10
	Neutral		
1.17	Max Partial discharge level at $1.58 * U_r / \sqrt{3}$	pC	100
1.18	Max Noise level at rated voltage and at principal tap at no load and all cooling Active	dB	80
1.19	Maximum Permissible Losses of Transformers		
i)	Max. No Load Loss at rated voltage and Frequency	kW	To suit the design requirements.

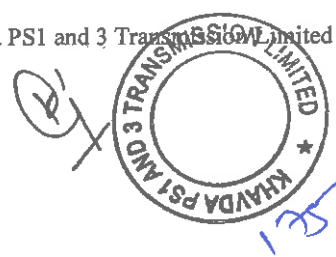

Transmission Service Agreement

Sl. No.	Description	Unit	Technical Parameters
ii)	Max. Load Loss at maximum continuous current and at 75° C	kW	To suit the design requirements.
iii)	Max. Auxiliary Loss at rated voltage and Frequency	kW	To suit the design requirements.

Notes:

1. No external or internal Transformers / Reactors are to be used to achieve the specified HV/MV impedances.
2. The criteria for Transformer losses shall be "Copper Loss (Load Loss) > Iron Loss (No Load Loss) > Cooler Loss (Auxiliary Loss)".
3. (*) marked parameters shall be decided based on STATCOM manufacturer's requirement.

A.8.10 STATCOM Station MV Switchgear

The MV Switchgear shall be designed with the aim to achieve operation according to the overall performance requirements of the STATCOM Station.

A.8.10.1 MV Circuit Breaker

The MV Circuit Breaker shall comply with the relevant IEC standard and all other relevant Standards, and as specified in this specification. They shall satisfy the General Technical Requirements and shall be designed to operate in the environmental conditions specified in this specification.

The Circuit Breaker offered should be of SF6 type/Vacuum type only and of class C2, M2 as per IEC

- i) The circuit breaker shall be complete with terminal connectors, operating mechanism, control cabinets, piping, interpole cable, cable accessories like glands, terminal blocks, marking ferrules, lugs, pressure gauges, density monitors (with graduated scale), galvanised support structure for CB and control cabinets, their foundation bolts and all other circuit breaker accessories required for carrying out all the functions the CB is required to perform.
- ii) All necessary parts to provide a complete and operable circuit breaker installation such as main equipment, terminals, control parts, connectors and other devices whether specifically called for herein or not shall be

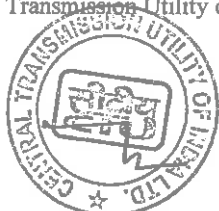

Transmission Service Agreement

provided.

- iii) The support structure of the circuit breaker shall be hot dip galvanized. Exposed hardware items shall be hot dip galvanized or Electro-galvanized.
- iv) MV Circuit Breaker shall be equipped with controlled switching with consequent optimization of switching behavior, when used in:
 - Switching of Capacitor Bank
 - Switching of shunt Reactor Bank
- v) Reactor Switching Duty test shall be conducted on MV Circuit Breaker in line with latest edition of IEC 62271-110.
- vi) Type Tested for Back-to-Back Capacitor Bank Switching as per latest edition of IEC 62271-100.
- vii) Routine tests as per IEC: 62271-100 shall be performed on all circuit breakers.
- viii) The medium voltage circuit breakers in any of the branches shall be designed to switch off metallic three phase short circuits only limited by the transformer impedance of the STATCOM System (Coupling transformer) with the initial short circuit current and DC component according to IEC 60909-0. Thereby the worst case time constant where the maximum short circuit peak and DC component occur shall be considered. The network shall be considered to deliver the maximum short circuit power of the substation.

A.8.10.2 MV Isolator and Earth Switch

The isolators and earth switches shall comply with the IEC and all other relevant Standards, and as specified in this specification. They shall satisfy the General Technical Requirements and shall be designed to operate in the environmental conditions specified in this specification.

- i) The isolators and accessories shall conform in general to IEC-62271 series as per relevance (or IS:9921) except to the extent explicitly modified in specification.
- ii) Earth switches shall be provided on isolators wherever called for.

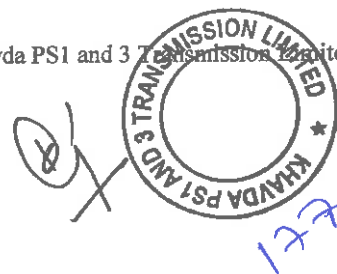
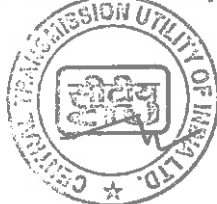

Transmission Service Agreement

- iii) Switches shall be motor operated with local and remote operation features and local manual operation features. Remote operation of Earth Switch is not required.
- iv) Disconnections and earth switches shall electrically and mechanically be interlocked. Castle Key interlocking facilities shall be provided to mechanically interlock the earth switch and Isolator to the doors of valve rooms.

A.8.10.3 Instrument Transformers for STATCOM Station

The instrument transformers shall comply with the relevant IEC Standards. They shall satisfy the general Technical Requirement specified in the specification and shall be designed to operate in the environmental conditions specified in this Specification. The instrument transformers provided for control, metering and protective relaying functions shall have voltage and current ratings, accuracy ratings and burden capabilities adequate to provide their designated functions within the overall accuracy requirement of the systems.

Voltage Transformers

Voltage transformers shall comply with the relevant IEC standards IEC 61869 (Part-1, Part-3 and Part-5).

Current Transformers

Current transformers shall comply with IEC 61869 (Part-1 and Part-2). Type tests and routine tests as per relevant IEC.

A.8.10.4 Surge Arrester

TSP shall install the surge arresters necessary for the protection of the equipment associated with the STATCOM Station in accordance with the requirements as per the insulation coordination study. The surge arresters shall give consistent protection to their associated equipment against overvoltage produced by lightning or switching surges, internal or external station faults, and other system disturbances.

The surge arresters shall be rated such that they are able to discharge a specified maximum energy due to the application of lightning, switching surges, temporary over voltages and faults as determined by insulation coordination studies, without coming into the temperature region where thermal runaway could result upon subsequent application of maximum transient and steady state voltage conditions.

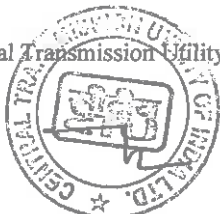

Handwritten signature or initials in blue ink.



Handwritten signature or initials in blue ink.

Transmission Service Agreement

The arrester housing shall be porcelain/composite type. The end fittings shall be made of non-magnetic and corrosion proof material.

Internal components shall be designed to eliminate internal corona and also to ensure minimal capacitive coupling with any conducting layer of pollutant on the outside of the porcelain housing. Particular attention shall be given to the high discharge currents which some of the arresters may experience in service due to discharge of stored energy of the AC filter and reactive compensating equipment, tripping of STATCOM etc.

A.8.11 STATCOM Station Auxiliary Power Supply

The auxiliary supply of STATCOM Station shall conform with the system requirements relating to reliability, availability, and redundancy, performing continuously to help ensure that the complete STATCOM Station operates as per the requirements. STATCOM station Auxiliary supply including all necessary switchgear (viz. AC/DC, lighting boards etc.) shall be completely separate from the main 400/220 kV substation auxiliary supply, all loads of STATCOM station shall be fed from this supply. The auxiliary supply provides power to the controllers, cooling system, station supplies, and various other essential and non-essential loads. With the exception of the cooling system, all other essential loads are also connected to the DC system of the STATCOM Station which is also to be provided separately from the DC system of the main 400/220 kV substation.

The auxiliary supply system shall be able to provide a stable supply for the STATCOM Station during system faults such as single-phase faults, phase-to-phase faults, and three-phase faults and LVRT (Low Voltage Ride Through) to allow continuous operation of the STATCOM Station during these transient events.

The auxiliary supply system of each STATCOM Station shall consist of two main incomers and one emergency incomer from DG set. The two main incomers shall be required to be paired to act redundantly to help ensure a certain degree of reliability and availability. One of the main incomers shall be supplied from 33 kV tertiary winding of 765/400/33 kV or 400/220/33 kV ICT at the main substation.

The other main incomer can be supplied from any one of the following three options:

- Supplied from Tertiary/Yoke winding of STATCOM coupling Transformer.
- Supplied from MV Bus Bar of STATCOM Station.
- Supplied from Power PT on HV side of coupling Transformer.

Central Transmission Utility of India Limited



133

Khavda PS1 and 3 Transmission Limited

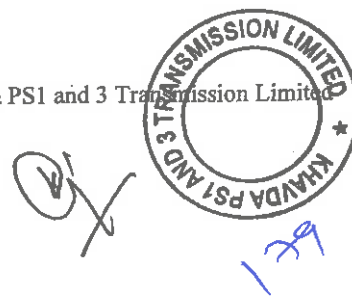
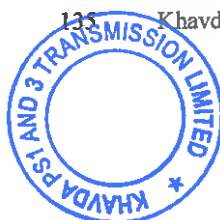

Transmission Service Agreement

Wherever the Voltage variation on the incomer is very high, a solid state AVR (Automatic Voltage Regulator) shall be provided to control the auxiliary supply voltage.

All MV incomers shall be provided with suitable CB, disconnector, instrument Transformer etc along with necessary protection system.

A.8.12 Fire Protection System for STATCOM Station:

Necessary fire protection for STATCOM units, Coupling Transformer, MSC, MCR and Harmonic filter (if any) shall be required. The main features of these protections are as under.

Fire Detection and Alarm System:

Suitable fire detection system using smoke detectors and/or heat detectors shall be provided in STATCOM Station for all room and areas. These smoke fire detection systems shall be connected to a separate Fire annunciation system clearly identifying the zone.

Hydrant System:

The hydrant system shall be extended from fire fighting system of the substation in the yard. Suitable number of hydrants shall be provided for protection of STATCOM Station equipment in the yard namely Coupling Transformer, MSCs, MSRs and Harmonic Filter (if required) etc as applicable for the station. Further suitable number of hydrants shall also be provided for STATCOM Station building

HVW System:

HVW (High Velocity Water) Spray system shall be provided for coupling transformer. The tapping for HVW system shall be done from nearby transformer/Reactor or any other suitable point of the main substation fire-fighting line.

Fire protection system shall be provided in accordance with the Central Electricity Authority (Measures relating to Safety and Electric Supply) Regulations, 2023.

A.8.13 Air-conditioning and ventilation system for STATCOM station

The STATCOM Station shall be provided with Air conditioning system as per requirement.

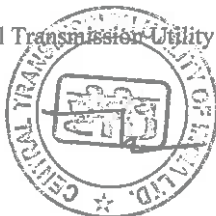

Handwritten signature or initials.

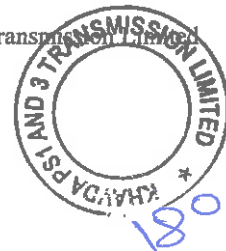

Transmission Service Agreement

1) AC System (Except Valve Hall):

Air condition system shall be provided for the following rooms in the STATCOM Building:

- a. Control and Relay room
- b. Battery room
- c. Conference Room
- d. Store cum workshop
- e. Cooling system room
- f. Lobby

Capacity and quantity of the AC units shall be decided based on heat load calculation and redundancy requirement.

2) Air-Conditioning System for Valve hall:

Air-Conditioning shall be provided for each Valve room for maintaining the following inside conditions round the year:

DBT - 35 °C (Maximum) Relative Humidity (RH) - 60% (Maximum)

The system shall be designed for an outside ambient temperature of 50 °C. Based on the above system design and parameters for valve room the AC system shall comprise "AHU and Air-cooled DX Condensing units" with one Main and one Standby unit for each room. The system shall be designed for 24 Hours, 365 Days of the year operation to maintain the inside temperatures of the Valve Hall for proper operation of the critical equipment. The air-cooled condensing unit shall be designed for continuous duty.

A.9 Engineering studies

The TSP shall carry out studies as brought out in this section with a model of the STATCOM in PSSE and PSCAD and documentation of the same shall be preserved & to be submitted to CEA/CTU, as per their requirement. The objective of these studies is to verify the steady state requirement of reactive power under normal and contingent operating conditions for peak and light loads conditions in the network.

The studies shall have to be carried out for

- Peak Load
- Light Load
- Contingency Conditions



Handwritten signature or initials.



Handwritten number 181.

Transmission Service Agreement

The load flow and dynamic file available with CTU shall be provided to the TSP in PSSE version 34 format. If data is not available typical data shall be assumed by TSP.

The studies should demonstrate that the STATCOM system meets all system and equipment specified performance criteria as per the specification. Engineering studies should include, but not be limited to, the studies described in subsequent subsections.

Base Case study files for Solar Max scenario (Feb'28) timeframe shall be shared separately through PSSE files wherein all the existing as well as envisaged system upto 2028-29 timeframe will be modelled using generic parameters as available with CTUIL. However, these generic parameters are to be fine-tuned to establish a converged dynamic case in steady state as well as the contingency cases. The fine tuning of the generic parameters shall be under the scope of TSP, which shall be done in consultation with CEA, CTUIL and Grid-India and the TSP share the final converged dynamic files with CTUIL, CEA and Grid-India.

A.9.1 System dynamic performance studies

Dynamic performance studies should verify that the STATCOM system controls the system's dynamic performance during system disturbances. Dynamic performance studies include the following:

- a. Studies verifying that the STATCOM provides adequate dynamic control to meet the system and STATCOM system performance criteria for the system conditions.
- b. Study of response time and of the STATCOM system's behavior and contribution to the system's recovery from faults.
- c. Studies to verify the operation of any supplementary controls designed to damp power oscillations following system disturbances.
- d. Studies to evaluate the interaction of the STATCOM controls with the other nearby control systems, including high-voltage direct current (HVDC) controls, generator controls, and controls of other flexible AC transmission systems (FACTS) devices

In addition to the above, relevant studies shall include the cases stated as mentioned in Annexure-I

A.9.2 Harmonic performance

The studies should evaluate resultant maximum harmonic levels at the STATCOM

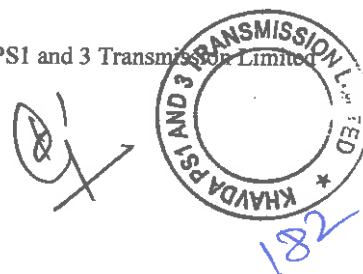

Transmission Service Agreement

system point of common coupling (PCC), and determine maximum stresses on all STATCOM system components. The study report should include the following:

- a. Evaluation of specified system and operating conditions (refer to Clause 5) under all possible STATCOM operating conditions.
- b. Evaluation within maximum ranges of STATCOM system component tolerances (worst performance values may not occur at detuning extremes).
- c. Evaluation with maximum system voltage unbalance (refers to item 8 and item 9 in Table 3 of Clause 5).
- d. Evaluation of the worst case resonance condition between STATCOM system and overall system.
- e. Evaluation of possible resonant over voltages.
- f. Transformer saturation induced harmonics for component rating calculation only.
- g. Evaluation of impact considering single phase auto reclose deadtime.

A.9.3 Electromagnetic transients, control performance, and overvoltage studies

Transient overvoltage studies should be performed with the actual control modeled to verify that the STATCOM system equipment is adequately protected against over voltages and over currents (including excessive valve recovery voltages) from power system transients resulting from switching, fault clearing events, and credible STATCOM system maloperations. Evaluation shall include the following:

- a. Study of start-up, including transformer energization, shutdown, switching coordination, and other local area network switching events
- b. Study of STATCOM system protection and protection coordination
- c. Faults on the high-voltage (HV) and MV bus (single line-to-ground, phase-to-phase, and three-phase)
- d. Faults across the VSC, capacitors, and other equipment if used.
- e. Control interaction

A.9.4 Insulation coordination study

Overall insulation coordination should be verified by considering the results of 8.4 (dynamic over voltages, and fault and switching transients), including the impacts of lightning surges on the STATCOM equipment. This study should determine and verify insulation levels, clearances, and arrester placement and ratings.

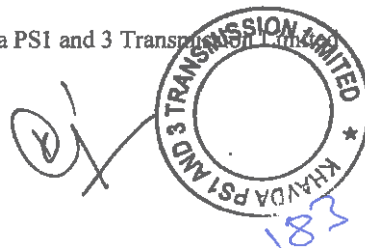

A.9.5 Other Studies

- a) Grounding Study
- b) Protection coordination
- c) PLC/radio interference
- d) Magnetic field strength
- e) Other studies as applicable

A.9.6 Software simulation models

The TSP shall provide the latest following PSCAD and PSSE simulation model(s) & parameters to CEA/CTU/GRID-INDIA alongwith detailed documentation for the purpose of future simulation to adequately represent and model the proposed STATCOM system in the respective software:

- a. **Stability model.** TSP should provide a detailed STATCOM system dynamics model for use in (PSCAD and PSSE) powerflow and stability simulation software. The model detail should be appropriate and complete for positive-sequence power system simulation and analysis that is typically performed with power flow and transient stability programs. All appropriate control features for such analysis will be modeled, and necessary documentation on the theory and use of model should be provided. Further, a generic model, benchmarked to detailed STATCOM stability model, shall also be furnished for distribution.
- b. **Transients model.** TSP should provide a detailed STATCOM transients model for use in PSCAD. The model detail should be appropriate and complete for the transient response calculation of the STATCOM system. All appropriate control features for such analysis will be modeled, and necessary documentation on the theory and use of model should be provided. Further, a generic model, benchmarked to detailed STATCOM transient model, shall also be furnished for distribution.

PSS/E files may be used for developing RTDS files/ models. For simulation of STATCOM in PSS/E file (load flow & dynamic) and PSCAD (Transient) model for STATCOM is required for study. TSP will share STATCOM models with CEA, CTU and Grid-India along with detailed documentation for above study purposes and simulations. For PSS/E, both Generic and User-defined models shall be shared by the TSP with the CEA, CTU and Grid-India. Generic model (PSS/E) response shall be benchmarked with user-defined model (PSS/E & PSCAD) to the extent possible by the TSP. Generic models can be shared by the CEA, CTU and Grid India with the concerned stakeholders/external party(ies) e. g. STUs etc. on need basis. For User Defined model, confidentiality shall be maintained by the CEA, CTU and Grid-India. For PSCAD, User Defined model shall be provided by the TSP for which

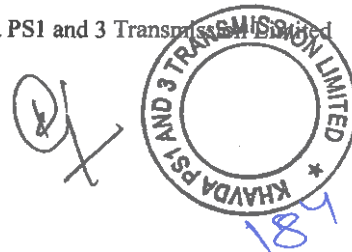
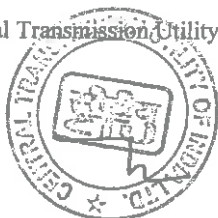

Transmission Service Agreement

confidentiality shall be maintained by the CEA, CTU and Grid-India.

Both UDM (PSCAD & PSS/E) and Generic model (PSSE) shall be provided by OEMs to CEA/CTU/GRID-INDIA without any NDA (Non-Disclosure Agreement).

For PSCAD, User Defined model shall be provided by the TSP for which confidentiality shall be maintained by the CEA, CTU & Grid-India.

A.9.7 Factory tests of controls

The integrated nature of the performance of the STATCOM in an electrical grid requires the following tests:

- a. The TSP should perform factory simulator system tests for integrated control and protection system to ensure the proper operation of the same. The control system should be connected to a digital simulator with adequate representation of the electrical network for various conditions. The STATCOM system controller needs to be representative of control functions, including basic controllers but inclusive of supplementary controls, firing controls, and protective functions integrated into the controllers. TSP shall submit the FAT (factory acceptance test) reports of STATCOM controls to CTU/RLDC
- b. The simulator should provide an accurate network representation including network harmonic behavior, as well as synchronous condensers, power stations, generators (with AVRs), and pump storage schemes, existing HVDC, SVCs and STATCOMs, future SVCs and STATCOMs, FSC (fixed series capacitors), and shunt reactors/capacitors/filters.

STATCOM system control function type tests on a simulator should include the following:

- Verification of each control function.
- Verification of control linearity.
- Verification of control redundancy.
- Verification of the monitoring system.
- Verification of the protection system with reference to integrated protective functions included in the Controllers and firing controllers.
- Verification of overall system performance for minor and major system disturbances.
- Verification of processor loading of all digital controllers.
- Verification of STATCOM system parallel operation with other controls in

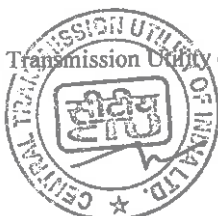

Handwritten signature or initials in blue ink.



Transmission Service Agreement
the system and control Stability.

- Verification of control equipment performance for auxiliary power supply voltage (AC and DC) and frequency variations (AC).
- Routine production tests of all control functions, and separately of all protection functions.

A.10.0 VISUAL MONITORING SYSTEM FOR WATCH AND WARD OF STATCOM STATION

Visual monitoring system (VMS) for effective watch and ward of STATCOM station premises covering the areas of entire switchyard, STATCOM building, Coupling Transformer, Cooling Towers and main gate, shall be provided. The TSP shall design, supply, erect, test and commission the complete system including cameras, Digital video recorder system, mounting arrangement for cameras, cables, LAN Switches, UPS and any other items/accessories required to complete the system.

Features of VMS system shall be as those specified for main substation. The number of cameras and their locations shall be decided in such a way that any location covered in the area can be scanned. The cameras shall be located in such a way to monitor at least:

- a) Coupling Transformer, Mechanically Switched Reactors (if any) and Mechanically Switched Capacitors (if any), AC filter banks (if any).
- b) STATCOM Valve hall, Cooling System, Electrical and Mechanical Auxiliary area.
- c) Entrance to STATCOM Station.
- d) All other Major Equipment (such as CB, CT, VT, SA etc.)

The cameras can be mounted on structures, buildings or any other suitable mounting arrangement.

A.11.0 Spares, Special Tools and Tackles

Considering the STATCOM as high technology proprietary equipment TSP shall ensure necessary spares are procured to maintain the necessary reliability and availability of STATCOM station. Further all necessary special tools and tackles required for erection, testing, commissioning, and maintenance of equipment shall also be taken.

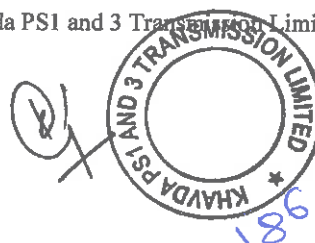

Contingency Cases for KPS1 (Bus Sections 1 & 2) & KPS3 (Bus Section 1) STATCOM

A) N-1 Contingency

↓ **Contingency at 765 kV level**

1. Three Phase Fault close to 765 kV bus of KPS1 S/s (Section-1) followed by tripping of one circuit of KPS1 S/s (Section-1) – Bhuj 765 kV D/c lines (1st) (fault persisted for 100 ms)
2. Single Phase to Ground Fault close to 765 kV bus of KPS1 S/s (Section-1) followed by single pole opening (100 ms) of the faulted phase and unsuccessful re-closure (dead time 1 second) followed by 3-pole opening (100 ms) of the faulted line i.e. tripping one circuit of KPS1 S/s (Section-1) – Bhuj 765 kV D/c lines (1st)
3. Three Phase Fault close to 765 kV bus of KPS1 S/s (Section-2) followed by tripping of one circuit of KPS1 S/s (Section-2) – KPS2 765 kV D/c line (fault persisted for 100 ms)
4. Single Phase to Ground Fault close to 765 kV bus of KPS1 S/s (Section-2) followed by single pole opening (100 ms) of the faulted phase and unsuccessful re-closure (dead time 1 second) followed by 3-pole opening (100 ms) of the faulted line i.e. tripping one circuit of KPS1 S/s (Section-2) – KPS2 765 kV D/c line
5. Three Phase Fault close to 765 kV bus of KPS3 S/s (Section-1) followed by tripping of one circuit of KPS3 S/s (Section-1) – KPS2 765 kV D/c line (fault persisted for 100 ms)
6. Single Phase to Ground Fault close to 765 kV bus of KPS3 S/s (Section-1) followed by single pole opening (100 ms) of the faulted phase and unsuccessful re-closure (dead time 1 second) followed by 3-pole opening (100 ms) of the faulted line i.e. tripping one circuit of KPS3 S/s (Section-1) – KPS2 765 kV D/c line
7. Three Phase Fault close to 765 kV bus of KPS3 S/s (Section-2) followed by tripping of one circuit of KPS3 S/s (Section-2) – Lakadia 765 kV D/c line (fault persisted for 100 ms)
8. Single Phase to Ground Fault close to 765 kV bus of KPS3 S/s (Section-2) followed by single pole opening (100 ms) of the faulted phase and unsuccessful re-closure (dead time 1 second) followed by 3-pole opening (100 ms) of the faulted line i.e. tripping one circuit of KPS3 S/s (Section-2) – Lakadia 765 kV D/c line
9. Three Phase Fault close to 765kV bus of KPS2 S/s followed by tripping of one circuit of KPS2 S/s – Lakadia 765 kV D/c line (fault persisted for 100 ms)
10. Single Phase to Ground Fault close to 765 kV bus of KPS2 S/s followed by single



Transmission Service Agreement

pole opening (100 ms) of the faulted phase and unsuccessful re-closure (dead time 1 second) followed by 3-pole opening (100 ms) of the faulted line i.e. tripping one circuit of KPS2 S/s – Lakadia 765 kV D/c line

11. Three Phase Fault close to 765 kV bus of KPS2 S/s followed by tripping of one circuit of KPS2 S/s – Halvad 765 kV D/c line (fault persisted for 100 ms)
12. Single Phase to Ground Fault close to 765 kV bus of KPS2 S/s followed by single pole opening (100 ms) of the faulted phase and unsuccessful re-closure (dead time 1 second) followed by 3-pole opening (100 ms) of the faulted line i.e. tripping one circuit of KPS2 S/s – Halvad 765 kV D/c line
13. Three Phase Fault close to 765 kV bus of Bhuj S/s followed by tripping of one circuit of Bhuj – Banaskantha 765 kV D/c line (fault persisted for 100 ms)
14. Single Phase to Ground Fault close to 765 kV bus of Bhuj S/s followed by single pole opening (100 ms) of the faulted phase and unsuccessful re-closure (dead time 1 second) followed by 3-pole opening (100 ms) of the faulted line i.e. tripping one circuit of Bhuj – Banaskantha 765 kV D/c line
15. Three Phase Fault close to 765 kV bus of Bhuj S/s followed by tripping of one circuit of Bhuj – Bhuj-II PS 765 kV D/c line (fault persisted for 100 ms)
16. Single Phase to Ground Fault close to 765 kV bus of Bhuj S/s followed by single pole opening (100 ms) of the faulted phase and unsuccessful re-closure (dead time 1 second) followed by 3-pole opening (100 ms) of the faulted line i.e. tripping one circuit of Bhuj – Bhuj-II PS 765 kV D/c line

↓ **Contingency at 400 kV level**

❖ **KPS1 (Bus Section 1)**

17. Three Phase Fault close to 400 kV bus of KPS1 S/s (Section-1) followed by tripping of one circuit of KPS1 S/s (Section-1) – Adani Renewable Energy Holding Four Limited (500+2000 MW) 400 kV D/c line (fault persist for 100 ms)
18. Single Phase to Ground Fault close to 400 kV bus of KPS1 S/s (Section-1) followed by single pole opening (100 ms) of the faulted phase and unsuccessful re-closure (dead time 1 second) followed by 3-pole opening (100 ms) of the faulted line i.e. tripping of one circuit of KPS1 S/s (Section-1) – Adani Renewable Energy Holding Four Limited (500+2000 MW) 400 kV D/c line
19. Three Phase Fault close to 400 kV bus of KPS1 S/s (Section-1) followed by tripping of KPS1 S/s (Section-1) – Adani Renewable Energy Holding Four Limited (1000 MW) 400 kV line (fault persist for 100 ms)
20. Single Phase to Ground Fault close to 400 kV bus of KPS1 S/s (Section-1) followed by single pole opening (100 ms) of the faulted phase and unsuccessful re-closure

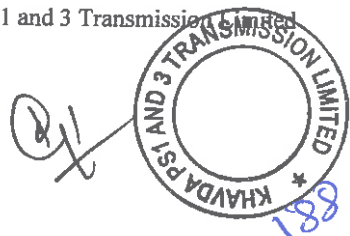
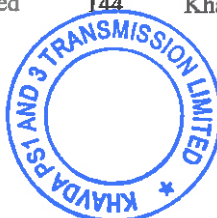

Transmission Service Agreement

(dead time 1 second) followed by 3-pole opening (100 ms) of the faulted line i.e. tripping of KPS1 S/s (Section-1) – Adani Renewable Energy Holding Four Limited (1000 MW) 400 kV line

21. Three Phase Fault close to 400 kV bus of KPS1 S/s (Section-1) followed by tripping of KPS1 S/s (Section-1) – Adani Green Energy Limited (1050 MW) 400 kV line (fault persist for 100 ms)
22. Single Phase to Ground Fault close to 400 kV bus of KPS1 S/s (Section-1) followed by single pole opening (100 ms) of the faulted phase and unsuccessful re-closure (dead time 1 second) followed by 3-pole opening (100 ms) of the faulted line i.e. tripping of KPS1 S/s (Section-1) – Adani Green Energy Limited (1050 MW) 400 kV line

❖ **KPS1 (Bus Section 2)**

23. Three Phase Fault close to 400 kV bus of KPS1 S/s (Section-2) followed by tripping of KPS1 S/s (Section-2) – Adani Green Energy Limited (250+1050 MW) 400 kV line (fault persisted for 100 ms)
24. Single Phase to Ground Fault close to 400 kV bus of KPS1 S/s (Section-2) followed by single pole opening (100 ms) of the faulted phase and unsuccessful re-closure (dead time 1 second) followed by 3-pole opening (100 ms) of the faulted line i.e. tripping of KPS1 S/s (Section-2) – Adani Green Energy Limited (250+1050 MW) 400 kV line
25. Three Phase Fault close to 400 kV bus of KPS1 S/s (Section-2) followed by tripping of KPS1 S/s (Section-2) – Adani Green Energy Limited (1000 MW) (Project-1) 400 kV line (fault persisted for 100 ms)
26. Single Phase to Ground Fault close to 400 kV bus of KPS1 S/s (Section-2) followed by single pole opening (100 ms) of the faulted phase and unsuccessful re-closure (dead time 1 second) followed by 3-pole opening (100 ms) of the faulted line i.e. tripping of KPS1 S/s (Section-2) – Adani Green Energy Limited (1000 MW) (Project-1) 400 kV line
27. Three Phase Fault close to 400 kV bus of KPS1 S/s (Section-2) followed by tripping of KPS1 S/s (Section-2) – Adani Green Energy Limited (1000 MW) (Project-2) 400 kV line (fault persisted for 100 ms)
28. Single Phase to Ground Fault close to 400 kV bus of KPS1 S/s (Section-2) followed by single pole opening (100 ms) of the faulted phase and unsuccessful re-closure (dead time 1 second) followed by 3-pole opening (100 ms) of the faulted line i.e. tripping of KPS1 S/s (Section-2) – Adani Green Energy Limited (1000 MW) (Project-2) 400 kV line
29. Three Phase Fault close to 400 kV bus of KPS1 S/s (Section-2) followed by tripping

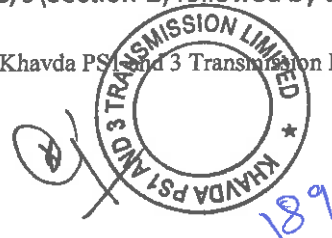
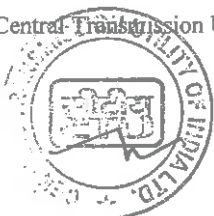

Transmission Service Agreement

of KPS1 S/s (Section-2) – Sarjan Realities Pvt Ltd. (1150 MW) 400 kV line (fault persisted for 100 ms)

30. Single Phase to Ground Fault close to 400 kV bus of KPS1 S/s (Section-2) followed by single pole opening (100 ms) of the faulted phase and unsuccessful re-closure (dead time 1 second) followed by 3-pole opening (100 ms) of the faulted line i.e. tripping of KPS1 S/s (Section-2) – Sarjan Realities Pvt Ltd. (1150 MW) 400 kV line

❖ **KPS3 (Bus Section 1)**

31. Three Phase Fault close to 400 kV bus of KPS3 S/s (Section-1) followed by tripping of KPS3 S/s (Section-1) – Adani Green Energy Limited (1050 MW) 400 kV line (fault persist for 100 ms)
32. Single Phase to Ground Fault close to 400 kV bus of KPS3 S/s (Section-1) followed by single pole opening (100 ms) of the faulted phase and unsuccessful re-closure (dead time 1 second) followed by 3-pole opening (100 ms) of the faulted line i.e. tripping of KPS3 S/s (Section-1) – Adani Green Energy Limited (1050 MW) 400 kV line
33. Three Phase Fault close to 400 kV bus of KPS3 S/s (Section-1) followed by tripping of KPS3 S/s (Section-1) – Sarjan Realities Pvt Ltd. (1250 MW) 400 kV line (fault persisted for 100 ms)
34. Single Phase to Ground Fault close to 400 kV bus of KPS3 S/s (Section-1) followed by single pole opening (100 ms) of the faulted phase and unsuccessful re-closure (dead time 1 second) followed by 3-pole opening (100 ms) of the faulted line i.e. tripping of KPS3 S/s (Section-1) – Sarjan Realities Pvt Ltd. (1250 MW) 400 kV line
35. Three Phase Fault close to 400 kV bus of KPS3 S/s (Section-1) followed by tripping of KPS3 S/s (Section-1) – Sarjan Realities Pvt Ltd. (1100 MW) 400 kV line (fault persisted for 100 ms)
36. Single Phase to Ground Fault close to 400 kV bus of KPS3 S/s (Section-1) followed by single pole opening (100 ms) of the faulted phase and unsuccessful re-closure (dead time 1 second) followed by 3-pole opening (100 ms) of the faulted line i.e. tripping of KPS3 S/s (Section-1) – Sarjan Realities Pvt Ltd. (1100 MW) 400 kV line
37. Three Phase Fault close to 400 kV bus of KPS3 S/s (Section-1) followed by tripping of KPS3 S/s (Section-1) – NTPC Renewable Energy Limited (1200 MW) 400 kV line (fault persisted for 100 ms)
38. Single Phase to Ground Fault close to 400 kV bus of KPS3 S/s (Section-1) followed by single pole opening (100 ms) of the faulted phase and unsuccessful re-closure (dead time 1 second) followed by 3-pole opening (100 ms) of the faulted line i.e. tripping of KPS3 S/s (Section-1) – NTPC Renewable Energy Limited (1200 MW) 400 kV line

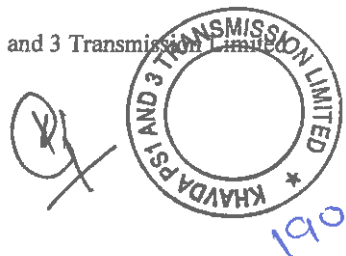

Transmission Service Agreement

B) N-1-1 Contingency

Contingency at 765 kV level

1. Case 1 & 2 (consider as separate cases) + Single Phase Fault close to 765 kV bus of KPS1 S/s (Section-1) followed by single pole opening (100 ms) of the faulted phase (2nd ckt of KPS1 S/s (Section-1) – Bhuj 765 kV D/c line (1st)) and successful re-closure (dead time 1 second)
2. Case 3 & 4 (consider as separate cases) + Single Phase Fault close to 765 kV bus of KPS1 S/s (Section-2) followed by single pole opening (100 ms) of the faulted phase (2nd ckt of KPS1 S/s (Section-2) – KPS2 765 kV D/c line) and successful re-closure (dead time 1 second)
3. Case 5 & 6 (consider as separate cases) + Single Phase Fault close to 765 kV bus of KPS3 S/s (Section-1) followed by single pole opening (100 ms) of the faulted phase (2nd ckt of KPS3 S/s (Section-1) – KPS2 765 kV D/c line) and successful re-closure (dead time 1 second)
4. Case 7 & 8 (consider as separate cases) + Single Phase Fault close to 765 kV bus of KPS3 S/s (Section-2) followed by single pole opening (100 ms) of the faulted phase (2nd ckt of KPS3 S/s (Section-2) – Lakadia 765 kV D/c line) and successful re-closure (dead time 1 second)
5. Case 9 & 10 (consider as separate cases) + Single Phase Fault close to 765 kV bus of KPS2 S/s followed by single pole opening (100 ms) of the faulted phase (2nd ckt of KPS2 S/s – Lakadia 765 kV D/c line) and successful re-closure (dead time 1 second)
6. Case 11 & 12 (consider as separate cases) + Single Phase Fault close to 765 kV bus of KPS2 S/s followed by single pole opening (100 ms) of the faulted phase (2nd ckt of KPS2 S/s – Halvad 765 kV D/c line) and successful re-closure (dead time 1 second)
7. Case 13 & 14 (consider as separate cases) + Single Phase Fault close to 765 kV bus of Bhuj S/s followed by single pole opening (100 ms) of the faulted phase (2nd ckt of Bhuj – Banaskantha 765 kV D/c line) and successful re-closure (dead time 1 second)

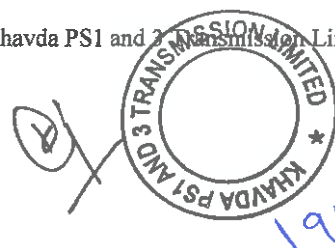
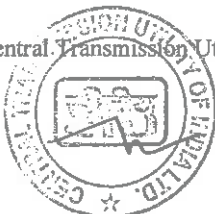

191

Transmission Service Agreement

8. Case 15 & 16 (consider as separate cases) + Single Phase Fault close to 765 kV bus of Bhuj S/s followed by single pole opening (100 ms) of the faulted phase (2nd ckt of Bhuj – Bhuj-II PS 765 kV D/c line) and successful re-closure (dead time 1 second)

STATCOM Station shall be capable of ride through for multiple voltage dips within pre-defined time window as per following curve:

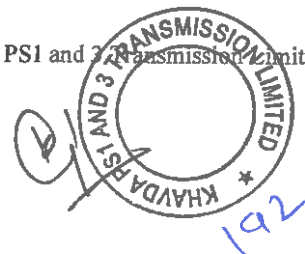
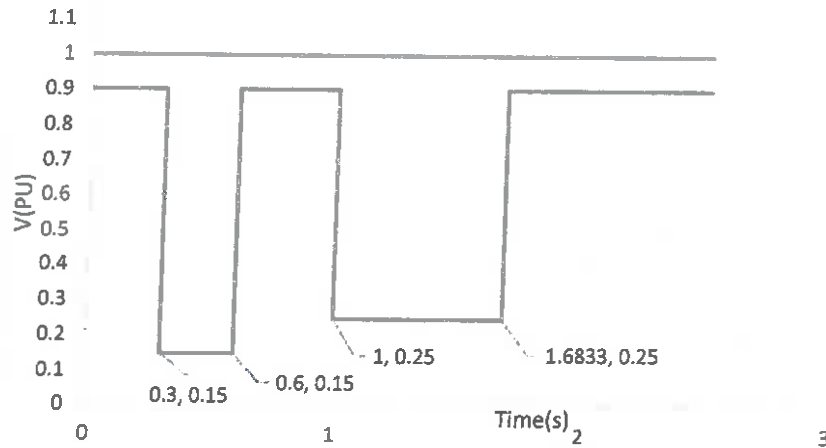

Transmission Service Agreement

SPECIFIC TECHNICAL REQUIREMENTS FOR SUBSTATION

The proposed extension of Khavda PS-1 (KPS1) substation & extension of Khavda PS-3 (KPS3) shall be Gas Insulated Switchgear (GIS) type generally conforming to the requirements of CEA (Technical Standards for Construction of Electrical Plants and Electric Lines) Regulations 2022, as amended from time to time. Other CEA Regulations and MoP guidelines, as applicable, shall also be followed.

B.1.0 Salient features of Substation Equipment and Facilities

The design and specification of substation equipment are to be governed by the following factors:

B.1.1 Insulation Coordination

The system design parameters for substations/switchyards shall be as given below:

Sl. No	Description of parameters	400kV Khavda PS-1 (KPS1) (GIS) Extn.	400kV Khavda PS-3 (KPS3) (GIS) Extn.
		400kV System	400kV System
1.	System operating voltage	400kV	400kV
2.	Maximum voltage of the system (rms)	420kV	420kV
3.	Rated frequency	50Hz	50Hz
4.	No. of phase	3	3
5.	Rated Insulation levels		
i)	Lighting Impulse withstand voltage for (1.2/50 micro sec.) - for Equipment other than Transformer and Reactors - for Insulator String	1425kVp	1425kVp

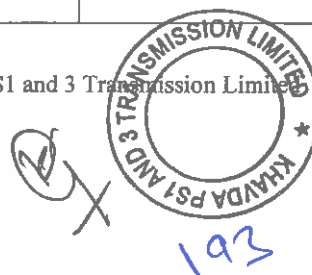

Transmission Service Agreement

Sl. No	Description of parameters	400kV Khavda PS-1 (KPS1) (GIS) Extn.	400kV Khavda PS-3 (KPS3) (GIS) Extn.
		400kV System	400kV System
		1550kVp	1550kVp
ii)	Switching impulse withstand voltage (250/2500 micro sec.) dry and wet	1050kVp	1050kVp
iii)	One minute power frequency dry withstand voltage (rms)	650kV	650kV
6.	Corona extinction voltage	320kV	320kV
7.	Max. radio interference voltage for frequency between 0.5 MHz and 2 MHz	1000 micro-volts at 266kV rms	1000 micro-volts at 266kV rms
8.	Minimum creepage distance for insulator string/ longrod insulators/ outdoor bushings	13020 mm (31mm/kV)	13020 mm (31mm/kV)
9.	Minimum creepage distance for switchyard equipment	13020 mm (31mm/kV)	13020 mm (31mm/kV)
10.	Max. fault current	63kA	63kA
11.	Duration of fault	1 Sec	1 Sec

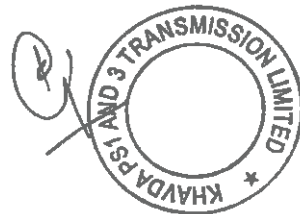

Transmission Service Agreement

B.1.2 Switching Scheme

The switching schemes, as mentioned below, shall be adopted at various voltage levels of substation/switchoyard:

Substation	400kV side
765/400kV Khavda PS-1 (KPS1) (GIS) Extn.	One & half breaker (GIS)
765/400kV Khavda PS-3 (KPS3) (GIS) Extn.	One & half breaker (GIS)

Notes: -

- i) In case of GIS substation where the bus scheme is One & Half breaker scheme, the diameters (diameter is a set of 3 circuit breakers with associated isolators, earth switches, current transformers etc. for controlling of 2 numbers feeders) shall be complete with feeder/line side isolator and GIS duct of the future bay shall be brought outside the GIS hall/building with extension/interface module suitably.
- ii) **400kV KPS1 Section-I & II:** The STATCOM under present scope shall be terminated in new diameters with bay configuration as STATCOM bay-Tie-ICT bay.
- iii) **400 kV KPS3 Section-I:** One number spare 400 kV GIS Line bay (Bay No. 404 in the SLD (Drg no. 023012-E-IS-SY-1L-0002 Rev H) attached herewith) is already existing. The STATCOM under present scope shall be terminated in this existing 400 kV GIS bay.

B.2.0 Substation Equipment and facilities (Voltage level as applicable):

The switchgear shall be designed and specified to withstand operating conditions and duty requirements. All equipment shall be designed considering the following capacity.

Sl. No	Description of bay	765/400kV Khavda PS-1 (KPS1) (GIS) Extn.	765kV Khavda PS-3 (KPS3) (GIS) Extn.
		400kV	400kV
1.	Bus Bar	4000A	4000A
2.	STATCOM bay	3150A	3150A

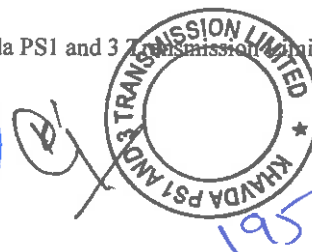

B.2.2 400 kV GIS Substation equipment

GIS (Gas Insulated Switchgear) shall be Indoor type in accordance to IEC: 62271-203. The switchgear shall be designed and specified to withstand operating conditions and duty requirements. All the switchgear such as Circuit Breaker, isolator, earth switch including CT, PT etc. shall be GIS type. The Surge Arrestor and Voltage Transformer shall be either GIS or outdoor AIS type.

The GIS assembly shall consist of separate modular compartments e.g. Circuit Breaker compartment, Bus bar compartment filled with SF₆ Gas and separated by gas tight partitions so as to minimize risk to human life, allow ease of maintenance and limit the effects of gas leaks failures & internal arcs etc. These compartments shall be designed to minimize the risk of damage to adjacent sections and protection of personnel in the event of a failure occurring within the compartments. Rupture diaphragms with suitable deflectors shall be provided to prevent uncontrolled bursting pressures developing within the enclosures under worst operating conditions, thus providing controlled pressure relief in the affected compartment. The arrangement of gas sections or compartments shall be such as to facilitate future extension of any make without any drilling, cutting or welding on the existing equipment. To add equipment, it shall not be necessary to move or dislocate the existing switchgear bays. The layout of Gas Insulated Bus Ducts shall be properly planned to optimize the length of bus ducts and for easy accessibility for maintenance. The length of busbars, bus ducts, isolator sections shall be optimized considering effects of fast transient voltage due to isolator operations.

The bus bar modules including auxiliary bus modules (wherever applicable) shall be provided with suitable End Piece (Interface) module with the test link facility for future extension as per provisions of future requirement. The end piece module shall be designed in such a way so that future GIS module may be tested without extending test voltage to existing bus and vice-versa by removing the test link. TSP shall make available the complete details for the design of interface module such as cross section, enclosure material, enclosure dimensions (inner & outer), Flange diameter (inner & outer), conductor cross-section & connection arrangement, bolt spacing & dimension, rated gas pressure, Gasket detail etc. Further, adequate space for GIS busbar interface module shall be taken into account for future scope.

Each section shall have plug-in or easily removable connection pieces to allow for easy replacement of any component with the minimum disturbance to the remainder of the equipment. Inspection windows (View Ports) shall be provided for Disconnecter Switches and both type of earth switches i.e. Maintenance and



Central Transmission Utility of India Limited



152

Khavda PS1 and 3 Transmission Limited

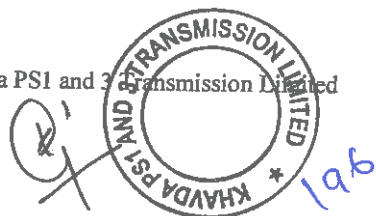

Transmission Service Agreement

fast operating.

Local control cabinets (LCC) shall be provided as per requirement. The alarm & annunciation of GIS equipment shall be wired to SCADA System.

The material and thickness of the enclosures shall be such as to withstand an internal flash over without burns through for a period of 300 ms at rated short time withstand current. The material shall be such that it has no effect of environment as well as from the by-products of SF₆ breakdown under arcing condition. This shall be validated with Type Test.

Service continuity requirement for GIS:

The GIS equipment with the given bus switching arrangement shall be divided into different gas compartments. During the work such as a fault repair or major maintenance, requiring the dismantling of a gas compartment for which more than one compartments may need to be de-gassed.

TSP shall meet following Service continuity conditions (to the extent possible) with ensuring equipment and operating personnel's safety:

- For One & half breaker bus switching scheme, during a fault in Circuit Breaker compartment, no bus bar and feeder is permitted out of service during maintenance and repair/replacement.
- During a fault in GIS compartment other than Circuit Breaker compartment, maximum one bus bar and/or one feeder is permitted out of service during maintenance and repair/replacement.

UHF sensors in GIS for PD (Partial Discharge) detection:

Adequate number of UHF sensors shall be provided in the offered GIS along with suitable portable type PD measuring instrument for detection of Partial discharge (of 5 pC and above as per IEC 60270). The number and location of these sensors shall be based on laboratory test on typical design of GIS as per recommendations of CIGRE Document No. 654 (Application Guide for sensitivity verification for UHF Partial discharge detection system for GIS).

B.2.2.1 Circuit Breakers (GIS)

GIS Circuit breakers shall in general be of C2-M2 class and comply to IEC-62271-100. The rated break time shall not exceed 40 ms (milli second) for 400 kV. Circuit

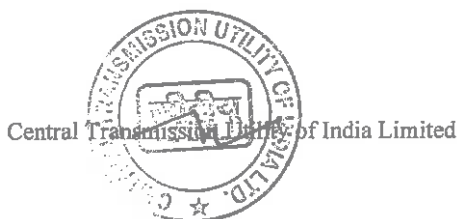

153

Khavda PSI and 3 Transmission Limited

197

Transmission Service Agreement

breakers shall be provided with single phase and three phase auto reclosing. Each breaker would have two sets of trip circuits which would be connected to separate DC supplies for greater reliability. The Circuit breakers controlling 400kV lines shall be provided with pre-insertion closing resistor of about 400 ohms with 8 ms insertion time or Controlled Switching Device (CSD). The short line fault capacity shall be same as the rated capacity and this is proposed to be achieved without use of opening resistors. Control switching device shall be provided in Circuit Breaker of switchable line reactor bay and in Main & Tie bay circuit breakers of line with non-switchable line reactors, Bus reactors and 765/400kV Transformers.

B.2.2.2 Isolators (GIS)

The isolators shall comply to IEC 62271-102 in general. Earth switches are provided at various locations to facilitate maintenance. Main blades and earth blades shall be interlocked and interlock shall be fail safe type. All isolators and earth switches shall be motor operated type.

Isolator shall be of extended mechanical endurance class-M2 and suitable for Bus Transfer Current Switching duty as per IEC standard. High speed earthing switches shall be provided for grounding purpose at overhead line terminations & cable terminations and shall have fault making capability as specified. Earth switch for line isolator shall be of earthing switch class E1 and shall be suitable for induced current switching duty as defined for Class-B as per relevant standard.

B.2.2.3 Current Transformers (GIS)

Current Transformers shall comply with IEC 61869 in general. All ratios shall be obtained by secondary taps only. Generally, Current Transformers (CT) shall have five cores (four for protection and one for metering) whereas; CT in Tie bays shall have six cores (four for protections & two for metering) suitably distributed on both sides of CB. The burden and knee point voltage shall be in accordance with the requirements of the system including possible feeds for telemetry. Accuracy class for protection core shall be PX and for metering core it shall be 0.2S. The rated burden of cores shall be closer to the maximum burden requirement of metering & protection system (not more than 20VA for metering core) for better sensitivity and accuracy.

The instrument security factor shall be less than 5 for CTs upto 400 kV voltage class.

B.2.2.4 Voltage Transformer (GIS)

The voltage transformers shall conform to IEC-61869. Voltage transformers shall be of electromagnetic type with SF₆ gas insulation. The earth end of the high voltage winding and the ends of the secondary winding shall be brought out in the

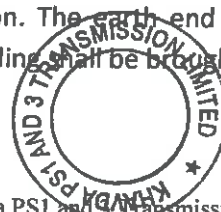
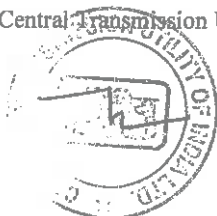

Handwritten signature and date '1/08'.

Transmission Service Agreement

terminal box. The voltage transformers shall be located as a separate bay module and will be connected phase to ground and shall be used for protection, metering and synchronization. The voltage transformers shall be of inductive type, nonresistant and shall be contained in their own-SF₆ compartment, separated from other parts of installation. The voltage transformer shall be effectively shielded against high frequency electromagnetic transients. The voltage transformer shall have three secondary windings out of which two shall be used for protection and one for metering. The voltage transformer should be thermally and dielectrically safe when the secondary terminals are loaded with the guaranteed thermal burdens. The accuracy class for protection cores shall be 3P. The accuracy of 0.2 on metering core should be maintained throughout the entire burden range on all the three windings without any adjustments during operation. The rated burden of cores shall be closer to the maximum burden requirement of metering & protection system (not more than 50VA for metering core) for better sensitivity and accuracy.

B.2.2.5 Surge Arresters (GIS) (if applicable)

336 kV Station High (SH) duty gapless type Surge arresters with thermal energy (Wth) of minimum 12 kJ/kV conforming to IEC 60099-4 in general shall be provided for 420 kV system. Other characteristics of Surge arrester shall be chosen in accordance with system requirements. Surge arresters shall be provided at line entrances, near transformers & Reactor so as to achieve proper insulation coordination. A leakage current monitor with surge counter shall be provided with each surge arrester.

B.2.2.6 SF₆ to Air Bushing

Outdoor bushings, for the connection of conventional external conductors to the SF₆ metal enclosed switchgear, shall be provided. Bushings shall generally be in accordance with the requirements of IEC-60137. The creepage distance over the external surface of outdoor bushings shall not be less than 31 mm/kV. SF₆ to air Bushing shall be of Polymer / composite type and shall be robust and designed for adequate cantilever strength to meet the requirement of seismic condition. The electrical and mechanical characteristics of bushings shall be in accordance with IEC-60137. Polymer / composite insulator shall be seamless sheath of silicon rubber compound. The housing & weather sheds should have silicon content of minimum 30% by weight. It should protect the bushing against environmental influences, external pollution and humidity. The hollow silicon composite insulators shall comply with the requirements of IEC 61462 and the relevant parts of IEC-62217.

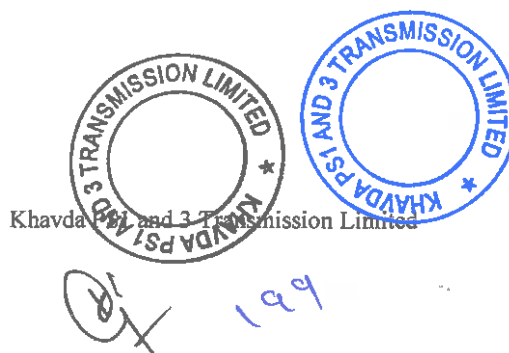

B.2.3 400kV AIS Substation equipment (as applicable)

B.2.3.1 Surge Arresters (AIS) (if applicable)

336 kV Station High (SH) duty gapless type Surge arresters with thermal energy (Wth) of minimum 12 kJ/kV conforming to IEC 60099-4 in general shall be provided for 420kV system. Other characteristics of Surge arrester shall be chosen in accordance with system requirements. Surge arresters shall be provided near line entrances, transformers & Reactor so as to achieve proper insulation coordination. Surge Arresters shall be provided with porcelain/ polymer housing fitted with pressure relief devices. A leakage current monitor with surge counter shall be provided with each surge arrester.

B.2.4 Protection Relaying & Control System

The protective relaying system proposed to be provided for transmission lines, auto- transformers, reactors and bus bars to minimize the damage to the equipment in the events of faults and abnormal conditions, is dealt in this section. All main protective relays shall be numerical type with IEC 61850 communication interface and should have interoperability during integration of numerical relays to communicate over IEC 61850 protocol with RTU/SAS/IEDs of different OEMs. All numerical relays shall have built in disturbance recording feature.

The protection circuits and relays of transformer and reactor shall be electrically and physically segregated into two groups each being independent and capable of providing uninterrupted protection even in the event of one of the protection groups failing, to obtain redundancy, and to take protection systems out for maintenance while the equipment remains in service.

a) Bus bar Protection

The high speed low impedance type bus bar differential protection, which is essential to minimize the damage and maintain system stability at the time of bus bar faults, shall be provided for 400kV buses. Duplicated bus bar protection is envisaged for 400kV bus-bar protection. Bus bar protection scheme shall be such that it operates selectively for each bus and incorporate necessary features required for ensuring security. The scheme shall have complete bus bar protection for present as well as envisaged future bays i.e. input / output modules for future bays shall also be provided.

Bus Bar protection system for new substation shall be de-centralized (distributed) type.



Transmission Service Agreement

In case, the bus section is provided, then each side of bus section shall have separate set of bus-bar protection schemes.

For existing substations, the existing bus bar protection shall be augmented as per requirement.

b) Local Breaker Back up Protection

This shall be provided for each 400kV and 220kV circuit breakers and will be connected to de-energize the affected stuck breaker from both sides.

Notes:

1. LBB & REF relays shall be provided separately from transformer differential relay.
2. LBB relay may also be provided as built-in protection function of distributed bus bar protection scheme; however, in such case separate LBB relay shall be provided for tie bays (in case of One and Half breaker scheme).
3. Over fluxing & overload protection can be provided as built-in feature of differential relay.
4. In 400kV switchyard, if spare bay of half diameter is identified as future, Tie CB relay panel shall be with Auto-reclosure feature.

B.2.5 Substation Automation System

- a) For all the new substations, state of art Substation Automation System (SAS) conforming to IEC-61850 shall be provided. The distributed architecture shall be used for Substation Automation system, where the controls shall be provided through Bay control units. The Bay control unit is to be provided bay wise for voltage level 220kV and above. All bay control units as well as protection units are normally connected through an Optical fiber high speed network. The control and monitoring of circuit breaker, dis-connector, re-setting of relays etc. can be done from Human Machine Interface (HMI) from the control room.

The functions of control, annunciation, disturbance recording, event logging and measurement of electrical parameters shall be integrated in Substation Automation System.

At new substations, the Substation Automation System (SAS) shall be suitable for operation and monitoring of the complete substation including proposed future bays/elements.

In existing substations with Substation automation system (SAS), augmentation of existing SAS shall be done for bays under present scope.

In existing Substations where Substation automation is not provided, control functions shall be done through control panels.

Central Transmission Utility of India Limited

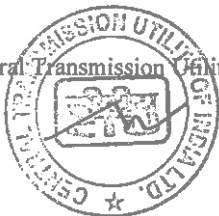

Khavda PS1 and 3 Transmission Limited



Handwritten signature and date "20/11/2011" in blue ink.

Transmission Service Agreement

Necessary gateway & modems (as required) shall be provided to send data to RLDC/SLDC as per their requirement. Any augmentation work at RLDC/SLDC is excluded from TSP's scope. However, all the configuration work at substation end required to send data to RLDC/SLDC shall be in the scope of TSP.

b) Time synchronisation equipment

Time synchronization equipment complete in all respect including antenna, cable, processing equipment required to receive time signal through GPS or from National Physical Laboratory (NPL) through INSAT shall be provided at new substations. This equipment shall be used to synchronize SAS & IEDs etc.

B.3.0 Substation Support facilities

For substation extensions, existing facilities shall be augmented as required.

B.3.1 Fire Fighting System

Fire-fighting system for substation including transformer & reactor shall conform to CEA (Measures Relating to Safety & Electric Supply) Regulations 2023.

Further, adequate water hydrants and portable fire extinguishers shall be provided in the substations. The main header of firefighting system shall be suitable for extension to bays covered under the future scope; necessary piping interface in this regard shall be provided.

Optical Beam type heat detection for GIS hall fire protection system shall be provided for all the GIS halls.

At existing substations, the fire-fighting systems as available shall be extended to meet the additional requirements.

B.3.2 Oil evacuating, filtering, testing & filling apparatus

To monitor the quality of oil for satisfactory performance of transformers, shunt reactors and for periodical maintenance necessary oil evacuating, filtering, testing and filling apparatus would be provided at new substations. Oil storage tanks of adequate capacities for storage of transformer oil would be provided.

B.3.3 Illumination

Normal & emergency AC & DC illumination shall be provided adequately in the control room & other buildings of the substation. The switchyard shall also be provided with adequate illumination.

Lighting of the entire control room building, fire-fighting pump house, other building (if any) and switchyard shall be done by LED based low power consumption luminaires.

Central Transmission Utility of India Limited

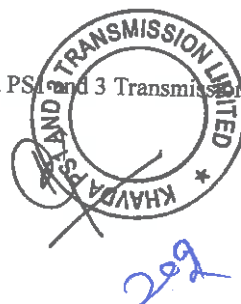
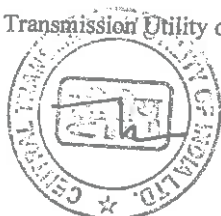

Khavda PS and 3 Transmission Limited

B.3.4 Control Room

For new substation, substation control room shall be provided to house substation work stations for station level control (SAS) along with its peripheral and recording equipment, AC & DC distribution boards, DC batteries & associated battery chargers, Fire Protection panels, Telecommunication panels & other panels as per requirements. Air conditioning shall be provided in the building as functional requirements. Main cable trenches from the control room shall have adequate space provision for laying of cables from control room for all the future bays also.

At existing substations, the adequacy of size of control room shall be ascertained and the same shall be augmented as per requirement.

B.3.5 GIS hall

The Gas Insulated Switchgear (GIS) of each voltage along with other associated equipment shall be housed inside the GIS building separately. The panels i.e. Bay level units, bay mimic, relay and protection panels, RTCC panels, PLCC panels, panels for tele-communication system etc. are to be placed in a separate room in the GIS building. The size of the room shall be such that all the panels for the bays under present scope shall be accommodated. The panel room shall be air-conditioned. Further, the temperature of the room shall be monitored through substation automation system by providing necessary temperature transducers. Ventilation system of suitable capacity shall be provided for each GIS hall.

One EOT Crane of suitable capacity for erection & Maintenance of largest GIS component/assembly and all plant installed in the GIS switchgear room shall be provided in each GIS hall. The crane shall be capable of fulfilling all special requirements for erection & maintenance of GIS equipment. The capacity of the crane shall be sized to lift the heaviest GIS switchgear component.

For extension of existing GIS, existing facilities shall be suitably augmented/extended for GIS equipment under present scope. **Further, space for additional 01 no. 400 kV diameter including space for maintenance bay and control, protection and communication panels shall be kept in the 400 kV GIS building to be constructed under present scope for each bus section (400 kV bus section-I & II) to accommodate future ICT/ Line bays.**

B.3.6 Control Concept

All the EHV circuit breakers in substation/switching stations shall be controlled and synchronized from the switchyard control room/remote control center. All the isolators shall have control from remote/local whereas the earth switches shall have local control only.

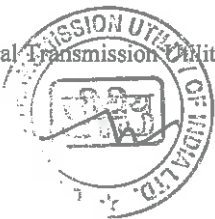

Handwritten signature and date 2023

B.3.7 Visual monitoring system (VMS) for watch and ward of substation premises:

Visual monitoring system for effective watch and ward of substation premises shall cover all the transformers and reactors, all other major AIS Equipment (such as CB, isolators, CT, CVT, SA etc. as applicable), GIS bays, panel room, all the gates of switchyard and all entry and exit points of control room building and accordingly the location of cameras shall be decided. The camera shall be high definition color CCD camera with night vision feature. The VMS data partly/completely shall be recorded (minimum for 15 days) at least @25fps (or better) and stored on network video recorder. The system shall use video signals from various cameras installed at different locations, process them for viewing on workstations/monitors in the control room and simultaneously record all the cameras.

Mouse/keyboard controllers shall be used for pan, tilt, zoom and other functions of the desired camera. The Visual Monitoring System shall have provision of WAN connectivity for remote monitoring.

All camera recordings shall have Camera ID & location/area of recording as well as date/time stamp. The equipment should generally conform to Electromagnetic compatibility requirement for outdoor equipment in EHV substation.

At existing substations, the visual monitoring system if available shall be augmented as per existing or better specification as required.

B.4.0 General Facilities

- a) Line Gantry/Towers are envisaged for bays under present scope only. However, for adjacent future line bay, tower shall be designed for extension (considering Quad conductors for 400kV future lines and Twin conductor for 220 kV future lines) wherever applicable.
- b) Bay extension works at existing substation shall be executed by TSP in accordance with the requirement/provisions mentioned above. However, interface points shall be considered keeping in view the existing design/arrangement at the substation.
- c) TSP has to arrange for construction power and water on its own.
- d) All outdoor steel structures including anchor/foundation bolts shall be fully galvanized. The weight of the zinc coating shall be at least 610 g/m². however, for coastal/creek regions it shall be at least 900 g/m².
- e) In 400 kV switchyard, if spare bay of half diameter is identified as future, all the equipment for Tie & Future bay shall be designed considering the current rating



203 A1

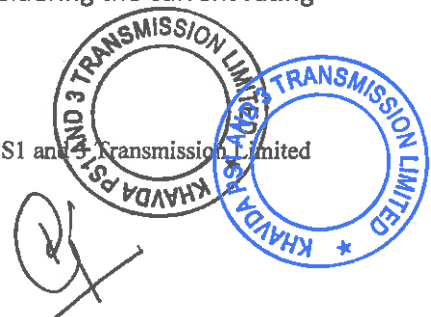

Transmission Service Agreement

of line bay i.e. 3150 A.

- f) Boundary wall shall be brick masonry wall with RCC frame or Stone masonry wall or Precast RCC wall under present scope along the property line of complete substation area including future switchyard area to prevent encroachment and unauthorized access. Minimum height of the boundary wall shall be of 1.8 m from finished ground level (FGL) as per CEA Measures Relating to Safety and Electric Supply Regulations.
- g) All electrical equipment shall be installed above Highest Flood Level and where such equipment is not possible to be installed above Highest Flood Level, it shall be ensured that there is no seepage or leakage or logging of water.

B.5 EXTENSION OF EXISTING SUBSTATION

The following drawings/details of existing substation are attached with the RFP documents for further engineering by the bidder.

Sl. No.	Drawing Title	Drawing No./Details	Rev. No.
A. 400kV KPS-1 Section-I (GIS) P.S.			
1.0	Single Line Diagram	KHVD_AUGSWYD_E_DRG_41_001	0
2.0	General Arrangement	5427XXXX-KHA-765-SYD-GSI-S2020-GA-0002	R2
3.0	Earthmat Layout	0778KH_KHVD_SWYD_E_DRG_27_001	
4.0	Visual Monitoring System	Yet to be finalized by the developer. The same may be availed from the developer on finalization.	
5.0	Bus Bar Protection	Make : GE Model: P741	
6.0	Substation Automation System (SAS)	Make: GE	
B. 400kV KPS-1 Section-II (GIS) P.S.			
1.0	Single Line Diagram	Yet to be finalized by the developer. The same may be availed from the developer on finalization.	
2.0	General Arrangement		
3.0	Earthmat Layout		
4.0	Visual Monitoring System		
5.0	Bus Bar Protection		
6.0	Substation Automation System (SAS)		

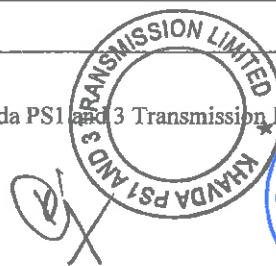
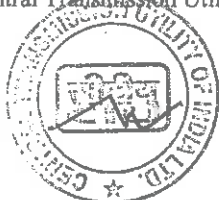

Transmission Service Agreement

C.	400kV KPS-3 Section-I (GIS) P.S.		
1.0	Single Line Diagram	023012-E-IS-SY-1L-0001	H
2.0	General Arrangement	023012-E-IS-SY-EL-0002	C
3.0	Earthmat Layout	Yet to be finalized by the developer. The same may be availed from the developer on finalization.	
4.0	Visual Monitoring System		
5.0	Bus Bar Protection		
6.0	Substation Automation System (SAS)		

Bidder is also advised to visit the substation sites and acquaint themselves with the topography, infrastructure such as requirement of roads, cable trench, drainage etc. and also the design philosophy.



SPECIFIC TECHNICAL REQUIREMENTS FOR COMMUNICATION

The communication requirement shall be in accordance to CEA (Technical Standards for Communication System in Power System Operations) Regulations, 2020, CEA (Technical Standards for Construction of Electrical Plants and Electric Lines) Regulations, 2022, CERC (Communication System for inter-State transmission of electricity) Regulations, 2017, and CEA (Cyber Security in Power Sector) Guidelines, 2021, all above documents as amended from time to time.

The complete ISTS communication system commissioned by TSP under the RFP shall be the asset of ISTS and shall be available for usage of ISTS requirements as suggested by CTU from time to time.

The protections for transmission line and the line compensating equipment shall have hundred percent back up communication channels i.e. two channels for tele-protection.

In order to meet the requirement for grid management and operation of substations, Transmission Service Provider (TSP) shall provide the following:

Specific Requirement for Phasor Measurement Units (PMUs)

TSP shall supply, install and commission required No. of Phasor Measurement Units (PMUs) at all the locations under the scope of TSP under this RFP as per CEA (Technical Standards for Construction of Electrical Plants and Electric Lines) Regulations, 2022 (along with all amendments if any), and all the applicable Regulations, Standards, Guidelines issued time to time.

TSP shall also supply, install and commission required No. of Phasor Measurement Units (PMUs) on HV side of coupling transformer at each STATCOM station and integrate with PDC.

These PMUs shall be provided with GPS clock and LAN switch and shall connect with LAN switch of control room of respective substations/ generating stations with Fibre Optic cable. These PMUs shall be connected with the FOTE at Substation/ generating stations for onwards data transmission to the PDC (Phasor Data Concentrator) located at respective RLDC. Configuration work in existing PDC at RLDC for new PMU integration shall be done by respective RLDC, however all the necessary support in this regard shall be ensured by TSP. The maintenance of all the PMUs and associated equipment shall be the responsibility of TSP. TSP has to provide PMUs for the availability of PMU signals in Coupling transformer of STATCOMs.



Handwritten signature or initials.



Schedule: 2

Scheduled COD

[Note: As referred to in the definition of "Element", "Scheduled COD", and in Articles 3.1.3 (c), 4.1 (b) and 4.3 (a) of this Agreement]

Sl. No.	Name of the Transmission Element	Scheduled COD	Percentage of Quoted Transmission Charges recoverable on Scheduled COD of the Element of the Project	Element(s) which are pre - required for declaring the Commercial operation(COD) of the respective Element
1.	± 300 MVAR STATCOM with 1x125 MVAR MSC, 2x125 MVAR MSR at KPS1, 400 kV Bus section-1 with 1 No. of 400 kV bay (GIS)	(07/11/2026)	33.334%	-
1.	± 300 MVAR STATCOM with 1x125 MVAR MSC, 2x125 MVAR MSR at KPS1, 400 kV Bus section-2 with 1 No. of 400 kV bay (GIS)		33.333%	-
2.	± 300 MVAR STATCOM with 1x125 MVAR MSC, 2x125 MVAR MSR at KPS3 400 kV Bus section-1 with 1 No. of 400 kV bay (GIS)		33.333%	-

The payment of Transmission Charges for any Element irrespective of its successful commissioning on or before its Scheduled COD shall only be considered after successful commissioning of the Element(s) which are pre-required for declaring the commercial operation of such Element as mentioned in the above table.

Scheduled COD for the Project: 24 Months from Effective Date.



Transmission Service Agreement

Schedule: 3

Safety Rules and Procedures

[Note: As referred to in Articles 5.6 of this Agreement]

1. Site Regulations and Safety:

The TSP shall establish Site regulations within sixty (60) days from fulfilment of conditions subsequent, as per Prudent Utility Practices setting out the rules to be observed till expiry of the Agreement at the Site and shall comply therewith.

Such Site regulations shall include, but shall not be limited to, rules in respect of security, safety of the Project, gate control, sanitation, medical care, and fire prevention, public health, environment protection, security of public life, etc.

Copies of such Site regulations shall be provided to the Nodal Agency and the CEA for the purpose of monitoring of the Project.

2. Emergency Work:

In cases of any emergency, the TSP shall carry out all necessary remedial work as may be necessary.

If the work done or caused to be done by any entity, other than the TSP, the TSP shall, reimburse the actual costs incurred, to the other Party carrying out such remedial works.

3. Site Clearance:

In the course of execution of the Agreement, the TSP shall keep the Site reasonably free from all unnecessary obstruction, storage, remove any surplus materials, clear away any wreckage, rubbish and temporary works from the Site, and remove any equipment no longer required for execution of the Agreement. After completion of all Elements of the Project, the TSP shall clear away and remove all wreckage, rubbish and debris of any kind from the Site, and shall leave the Site clean and safe.

4. Watching and Lighting:

The TSP shall provide and maintain at its own expense all lighting, fencing, and watching when and where necessary for the proper construction, operation, maintenance / repair of any of the Elements of the Project, or for the safety of the owners and occupiers of adjacent property and for the safety of the public, during such maintenance / repair.

Central Transmission Utility of India Limited

165

Khavda PS1 and 3 Transmission Limited

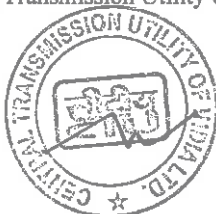

Handwritten signature or initials.



203 AL

Transmission Service Agreement

Schedule: 4

Computation of Transmission Charges

1.1 General

The Monthly Transmission Charges to be paid to the TSP for providing Transmission Service for any Contract Year during the term of the Agreement shall be computed in accordance with this Schedule and paid as per Sharing Regulations.

Illustration regarding payment of Transmission Charges under various scenarios (considering definitions of Contract Year, Expiry Date & Monthly Transmission Charges above) is as below: -

Illustration-1: In case the Project Elements achieve COD as per Schedule

Quoted Transmission Charges: Rs. 140 Million

Completion Schedule:

Element No.	Completion Schedule in Months	Scheduled CoD of the Element	Actual CoD of the Element	% Charges recoverable on Scheduled CoD of the Element
Element 1	28	1-Feb-2018	1-Feb-2018	25%
Element 2	38	1-Dec-2018	1-Dec-2018	75%

Tariff Payable as follows:

Transmission Charges for Element 1			Transmission Charges for Element 2		
1-Feb-18 to 31-Mar-18	140 X 25% X ((28+31)/365)	5.65		--	0.00
1-Apr-18 to 30-Nov-18	140 X 25% X (244/365)	23.39		--	0.00
1-Dec-18 to 31-Mar-19	140 X 100% X (121/365)				46.41
2	140 X 100% X 1				140
3	140 X 100% X 1				140
4	140 X 100% X 1				140
5	140 X 100% X 1				140
.....					
.....					
36 (1-Apr to 30-Nov)	140 X 100% X (244/365)				93.59

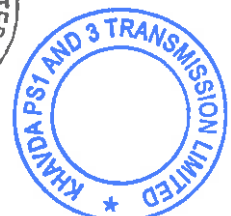
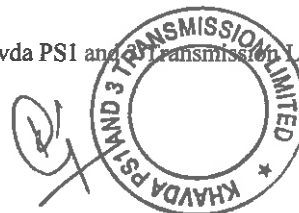
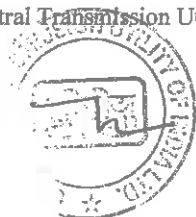

Transmission Service Agreement

Illustration-2: In case of extension of Scheduled COD as per Article 4.4.1 & 4.4.2 of this Agreement

Quoted Transmission Charges: **Rs. 140 Million**

Completion Schedule:

Element No.	Completion Schedule in Months	Scheduled CoD of the Element	Actual CoD of the Element	% Charges recoverable on Scheduled CoD of the Element
Element 1	20	1-Feb-2018	1-Jul-2018	25%
Element 2	28	1-Oct-2018	1-Dec-2018	75%

Tariff Payable as follows:

Transmission Charges for Element 1			Transmission Charges for Element 2		
1-Feb-18 to 31-Mar-18	--	0.00		--	0.00
1-Apr-18 to 30-Jun-18	--	0.00		--	0.00
1-Jul-18 to 30-Nov-18	140 X 25% X (153/365)	14.67		--	0.00
1-Dec-18 to 31-Mar-19	140 X 100% X (121/365)				46.41
2	140 X 100% X 1				140
3	140 X 100% X 1				140
4	140 X 100% X 1				140
5	140 X 100% X 1				140
.....					
.....					
36 (1-Apr to 30-Nov)	140 X 100% X (244/365)				93.59

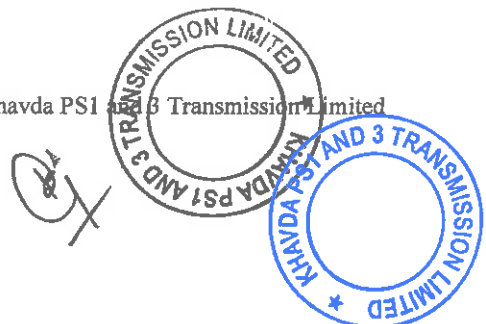

Transmission Service Agreement

Illustration-3: In case of delay in achieving COD of Project & all individual Elements (COD) of the Project achieved in Contract Year 1)

Quoted Transmission Charges: Rs. 140 Million

Completion Schedule:

Element No.	Completion Schedule in Months	Scheduled CoD of the Element	Actual CoD of the Element	% Charges recoverable on Scheduled CoD of the Element
Element 1	20	1-Feb-2018	1-Dec-2018	25%
Element 2	28	1-Oct-2018	1-Dec-2018	75%

Tariff Payable as follows:

Transmission Charges for Element 1			Transmission Charges for Element 2		
1-Feb-18 to 31-Mar-18	--	0.00		--	0.00
1-Apr-18 to 30-Sept-18	--	0.00		--	0.00
1-Oct-18 to 30-Nov-18	--	0.00	1-Oct-18 to 30-Nov-18	--	0.00
1-Dec-18 to 31-Mar-19	140 X 100% X (121/365)				46.41
2	140 X 100% X 1				140
3	140 X 100% X 1				140
4	140 X 100% X 1				140
5	140 X 100% X 1				140
.....					
.....					
36 (1-Apr to 30-Nov)	140 X 100% X (244/365)				93.59

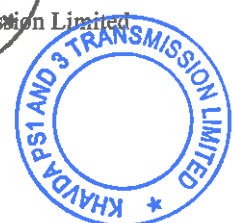
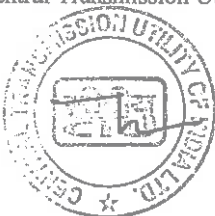

Transmission Service Agreement

Illustration-4: In case of delay in achieving COD of Project & all individual Elements (COD of the Project achieved in Contract Year other than Contract Year 1)

Quoted Transmission Charges: Rs. 140 Million

Completion Schedule:

Element No.	Completion Schedule in Months	Scheduled CoD of the Element	Actual CoD of the Element	% Charges recoverable on Scheduled CoD of the Element
Element 1	38	1-Oct-2019	1-May-2020	25%
Element 2	38	1-Oct-2019	1-May-2020	75%

Tariff Payment to be paid as:

Transmission Charges for Element 1			Transmission Charges for Element 2		
1-Oct-19 to 31-Mar-20	--	0.00	1-Oct-19 to 31-Mar-20	--	0.00
1-Apr-20 to 30-Apr-20	-	0.00	1-Apr-20 to 30-Apr-20	-	0.00
1-May-20 to 31-Mar-21	140 X 100% X (335/365)				128.49
2	140 X 100% X 1				140
3	140 X 100% X 1				140
4	140 X 100% X 1				140
5	140 X 100% X 1				140
.....					
.....					
36 (1-Apr to 30-Apr)	140 X 100% X (30/ 365)				11.51

Central Transmission Utility of India Limited

169

Khavda PS1 and 3 Transmission Limited



203 A10

Transmission Service Agreement

Illustration5: In case of delay in achieving COD of Element but Project COD achieved on time

Quoted Transmission Charges: **Rs. 140 Million**

Completion Schedule:

Element No.	Completion Schedule in Months	Scheduled CoD of the Element	Actual CoD of the Element	% Charges recoverable on Scheduled CoD of the Element
Element 1	20	1-Feb-2018	1-Jul-2018	25%
Element 2	30	1-Dec-2018	1-Dec-2018	75%

Tariff Payable as follows:

Transmission Charges for Element 1			Transmission Charges for Element 2		
1-Feb-18 to 31-Mar-18	--	0.00		--	0.00
1-Apr-18 to 30-Jun-18	--	0.00		--	0.00
1-Jul-18 to 30-Nov-18	140 X 25% X (153/365)	14.67		--	0.00
1-Dec-18 to 31-Mar-19	140 X 100% X (121/365)				46.41
2	140 X 100% X 1				140
3	140 X 100% X 1				140
4	140 X 100% X 1				140
5	140 X 100% X 1				140
.....					
.....					
36 (1-Apr to 30-Nov)	140 X 100% X (244/365)				93.59

Central Transmission Utility of India Limited

170

Khavda PS1 and 2 Transmission Limited

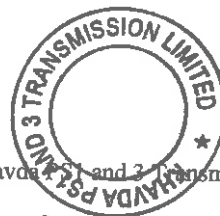

203 A11

Illustration-6: In case of early commissioning of Project

Quoted Transmission Charges: Rs. 140 Million

Completion Schedule:

Element No.	Completion Schedule in Months	Scheduled CoD of the Element	Actual CoD of the Element	% Charges recoverable on Scheduled CoD of the Element
Element 1	38	1-Oct-2019	1-Jul-2019	25%
Element 2	38	1-Oct-2019	1-Jul-2019	75%

Tariff Payment to be paid as:

Transmission Charges for Element 1		Transmission Charges for Element 2	
1-July-19 to 31-Mar-20	140 X 100% X (274/365)		105.09
2	140 X 100% X 1		140
3	140 X 100% X 1		140
4	140 X 100% X 1		140
5	140 X 100% X 1		140
.....			
.....			
36 (1-Apr to 30-Jun)	140 X 100% X (91/365)		34.91

Illustration-7: In case of early commissioning of an element

Quoted Transmission Charges: Rs. 140 Million

Completion Schedule:

Element No.	Completion Schedule in Months	Scheduled CoD of the Element	Actual CoD of the Element	% Charges recoverable on Scheduled CoD of the Element
Element 1	38	1-Oct-2019	1-Apr-2019	25%
Element 2	38	1-Jul-2019	1-Jul-2019	75%

Tariff Payment to be paid as:

Transmission Charges for Element 1	Transmission Charges for Element 2
------------------------------------	------------------------------------

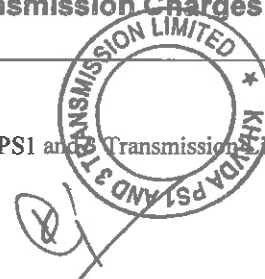

Transmission Service Agreement

1-Apr-2019 to 30-Jun-19	140 X 25% X (91/365)	8.72	1-Apr-2019 to 30-Jun-19	--	0.00
1-July-19 to 31-Mar-20	140 X 100% X (274/ 365)				105.09
2	140 X 100% X 1				140
3	140 X 100% X 1				140
4	140 X 100% X 1				140
5	140 X 100% X 1				140
.....					
.....					
36 (1-Apr-30-Jun)	140 X 100% X (91/365)				34.91

The Transmission Charges shall be payable on monthly basis as computed above.

1.2 Computation of Monthly Transmission Charges

The Monthly Transmission Charges for any month m in a Contract Year n shall be calculated as below:

For AC System:

- a. If Actual Transmission System Availability for the month m of contract year n is greater than or equal to 98% and less than or equal to 98.5%;

Monthly Transmission Charges $MTC(m) = Tmn * 1$

- b. If Actual Transmission System Availability for the month m of contract year n exceeds 98.5% and less than or equal to 99.75%;

Monthly Transmission Charges $MTC(m) = Tmn * (AA / 98.5\%)$

- c. If Actual Transmission System Availability for the month m of contract year n is greater than 99.75%;

Monthly Transmission Charges $MTC(m) = Tmn * (99.75\% / 98.5\%)$

- d. If Actual Transmission System Availability for the month m of contract year n is less than 98% and greater than or equal to 95.00%;

Monthly Transmission Charges $MTC(m) = Tmn * (AA / 98\%)$

- e. If Actual Transmission System Availability for the month m of contract year falls below 95%;

Monthly Transmission Charges $MTC(m) = Tmn * (AA / 98\%) - 0.02 * (Tmn * (AA / 95\%))$

For DC System:

- a. If Actual Transmission System Availability for the month m of contract year n is greater than or equal to 95% and less than or equal to 96%;

Monthly Transmission Charges $MTC(m) = Tmn * 1$

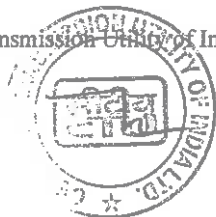

203 A13

Transmission Service Agreement

- b. If Actual Transmission System Availability for the month m of contract year n exceeds 96% and less than or equal to 99.75%;

$$\text{Monthly Transmission Charges MTC}(m) = T_{mn} * (AA/ 96\%)$$

- c. If Actual Transmission System Availability for the month m of contract year n is greater than 99.75%;

$$\text{Monthly Transmission Charges MTC}(m) = T_{mn} * (99.75\% / 96\%)$$

- d. If Actual Transmission System Availability for the month m of contract year n is less than 95% and greater than or equal to 92.00%;

$$\text{Monthly Transmission Charges MTC}(m) = T_{mn} * (AA/ 95\%)$$

- e. If Actual Transmission System Availability for the month m of contract year falls below 92%;

$$\text{Monthly Transmission Charges MTC}(m) = T_{mn} * (AA/ 95\%) - 0.02 * (T_{mn} * (AA/ 92\%))$$

where:

- AA is the actual Availability, as certified by RPC, as per procedure provided in Schedule 6.
- m is the month in Contract Year 'n'
- T_{mn} = Transmission Charges for the month 'm' in Contract Year 'n' = (=Transmission Charge/ no. of days in the Year n)* no. of days in month m

Provided, no Transmission Charges shall be paid during the period for which the RLDC has not allowed the operation of the Element/Project due to the failure of the TSP to operate it as per the provisions of the Grid Code.

1.3 RLDC Fee & Charges

The payment of RLDC fee & charges, in accordance with relevant regulations of CERC, shall be the responsibility of the TSP.

Central Transmission Utility of India Limited

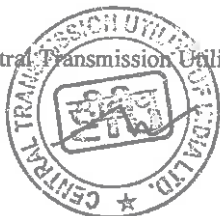

173

Khavda PS and 3 Transmission Limited

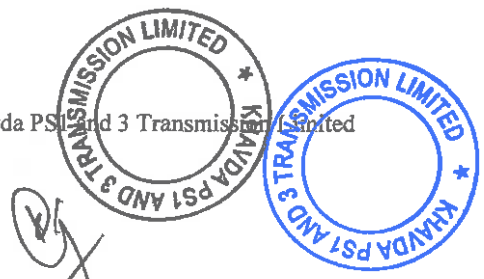

203 A14

Schedule: 5

Quoted Transmission Charges

[Quoted Transmission Charges from Annexure - 21 of the RFP of the Selected Bidder to be inserted here]

[To be incorporated from the Bid of the Selected Bidder submitted during the e-reverse auction after its selection]

Quoted Transmission Charges: Rs.1077.25Million

Proportionate Transmission Charges payable for each Element of the Project:

Provision of Dynamic Reactive Power Compensation at KPS1 and KPS3		
S. No.	Name of Transmission Element	Percentage of Quoted Transmission Charges Recoverable on Scheduled COD of the Element of the Project
4.	300 MVAR STATCOM with 1x125 MVAR MSC, 2x125 MVAR MSR at KPS1, 400 kV Bus section-1 with 1 No. of 400 kV bay (GIS) <ul style="list-style-type: none"> ± 300 MVAR STATCOM with 1x125 MVAR MSC, 2x125 MVAR MSR 400 kV bay (GIS) – 1 No. (KPS1 Bus Section-1) 	33.334%
5.	± 300 MVAR STATCOM with 1x125 MVAR MSC, 2x125 MVAR MSR at KPS1, 400 kV Bus section-2 with 1 No. of 400 kV bay (GIS) <ul style="list-style-type: none"> ± 300 MVAR STATCOM with 1x125 MVAR MSC, 2x125 MVAR MSR 400 kV bay (GIS) – 1 No.(KPS1 Bus Section-2) 	33.333%
6.	± 300 MVAR STATCOM with 1x125 MVAR MSC, 2x125 MVAR MSR at KPS3 400 kV Bus section-1 with 1 No. of 400 kV bay (GIS) <ul style="list-style-type: none"> ± 300 MVAR STATCOM with 1x125 MVAR MSC, 2x125 MVAR MSR 400kV bay (GIS) – 1 No. (KPS3 Bus Section-1) 	33.333%

Note:

- TSPs of KPS1 and KPS3 shall provide space for 400 kV bay(s), as may be required, for termination of STATCOM under present scope.
- Land for installation of STATCOM (with MSC/MSR) as specified above shall be arranged by TSP implementing the STATCOM.
- Bay(s) required for completion of diameter (GIS) in one-and-half breaker scheme, shall also be executed by the TSP under the present scope.

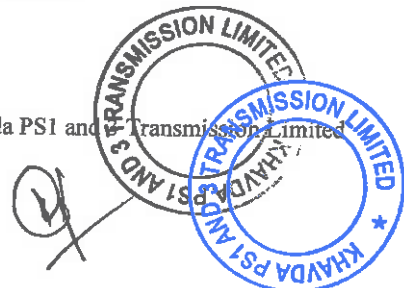
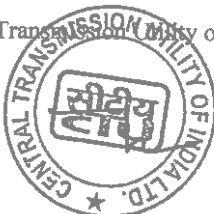

Schedule: 6

Appendix –IV to Central Electricity Regulatory Commission (Terms and Conditions of Tariff) Regulations, 2024

Procedure for Calculation of Transmission System Availability Factor for a Month

1. Transmission system availability factor for nth calendar month ("TAFPn") shall be calculated by the respective transmission licensee, verified by the concerned Regional Load Dispatch Centre (RLDC) and certified by the Member-Secretary, Regional Power Committee of the region concerned, separately for each AC and HVDC transmission system and grouped according to sharing of transmission charges. In the case of the AC system, transmission System Availability shall be calculated separately for each Regional Transmission System and inter-regional transmission system. In the case of the HVDC system, transmission System Availability shall be calculated on a consolidated basis for all inter-state HVDC systems.
2. Transmission system availability factor for nth calendar month ("TAFPn") shall be calculated by considering the following:
 - i) **AC transmission lines:** Each circuit of AC transmission line shall be considered as one element;
 - ii) **Inter-Connecting Transformers (ICTs):** Each ICT bank (three single phase transformers together) shall form one element
 - iii) **Static VAR Compensator (SVC):** SVC, along with SVC transformer, shall form one element;
 - iv) **Bus Reactors or Switchable line reactors:** Each Bus Reactors or Switchable line reactors shall be considered as one element;
 - v) **HVDC Bi-pole links:** Each pole of the HVDC link, along with associated equipment at both ends, shall be considered as one element;
 - vi) **HVDC back-to-back station:** Each block of the HVDC back-to-back station shall be considered as one element. If the associated AC line (necessary for the transfer of inter-regional power through the HVDC back-to-back station) is not available, the HVDC back-to-back station block shall also be considered unavailable;
 - vii) **Static Synchronous Compensation ("STATCOM"):** Each STATCOM shall be considered as separate element.
3. The Availability of AC and HVDC portion of Transmission system shall be calculated by considering each category of transmission elements as under

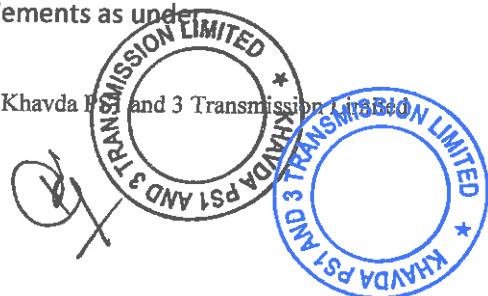

Transmission Service Agreement

LAFPa (in %) for AC system:

$$\frac{(v \times AV_v) + (p \times AV_p) + (q \times AV_q) + (r \times AV_r) + (u \times AV_u)}{v + p + q + r + u} \times 100$$

Where

- v = Total number of AC lines.
- AV_v = Availability of v number of AC lines.
- p = Total number of bus reactors/switchable line reactors.
- AV_p = Availability of p number of bus reactors/switchable line reactors.
- q = Total number of ICTs.
- AV_q = Availability of q number of ICTs.
- r = Total number of SVCs.
- AV_r = Availability of r number of SVCs.
- u = Total number of STATCOM.
- AV_u = Availability of u number of STATCOM.

LAFMn (in %) for HVDC System:

$$\frac{\sum_{x=1}^n Cxbp(act) \times AVxbp + \sum_{y=1}^m Cybhb(act) \times AVyhb}{\sum_{x=1}^n Cxbp + \sum_{y=1}^m Cybhb} \times 100$$

Where

- Cxbp(act) = Total actual operated capacity of xth HVDC pole.
- Cxbp = Total rated capacity of xth HVDC pole.
- AVxbp = Availability of xth HVDC pole.
- Cybhb(act) = Total actual operated capacity of yth HVDC back-to-back station block.
- Cybhb = Total rated capacity of yth HVDC back-to-back station block.
- AVyhb = Availability of yth HVDC back-to-back station block.
- n = Total no of HVDC poles.
- m = Total no of HVDC Back to Back blocks.

Central Transmission Utility of India Limited

176

Khavda PS1 and 2 Transmission Limited

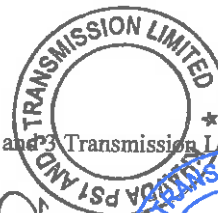

203 A17

Transmission Service Agreement

4. The availability for each category of transmission elements shall be calculated based on the weightage factor, total hours under consideration and non-available hours for each element of that category. The formulae for calculation of the Availability of each category of the transmission elements are as per Appendix-V. The weightage factor for each category of transmission elements shall be considered as under:
- For each circuit of the AC line – The number of sub-conductors in the line multiplied by ckt-km;
 - For each HVDC pole- The rated MW capacity x ckt-km;
 - For each ICT bank – The rated MVA capacity;
 - For SVC- The rated MVAR capacity (inductive and capacitive)
 - For Bus Reactor/switchable line reactors – The rated MVAR capacity;
 - For HVDC back-to-back stations connecting two Regional grids- Rated MW capacity of each block; and
 - For STATCOM – Total rated MVAR Capacity
5. The transmission elements under outage due to following reasons shall be deemed to be available:
- Shut down availed for maintenance of another transmission scheme or construction of new element or renovation/upgradation/additional capitalization in an existing system approved by the Commission. If the other transmission scheme belongs to the transmission licensee, the Member Secretary, RPC may restrict the deemed availability period to that considered reasonable by him for the work involved. In case of a dispute regarding deemed availability, the matter may be referred to the Chairperson, CEA, within 30 days.
 - Switching off of a transmission line to restrict over-voltage and manual tripping of switched reactors as per the directions of the concerned RLDC.
 - Shut down of a transmission line due to the Project(s) of NHAI, Railways and Border Road Organization, including for shifting or modification of such transmission line or any other infrastructure project approved by Ministry of Power. Member Secretary, RPC may restrict the deemed availability period to that considered reasonable by him for the work involved;
- Provided that apart from the deemed availability, any other costs involved in the process of such shutdown of transmission line shall not be borne by the DICs. Provided that such deemed availability shall be considered only for the period for which DICs are not affected by the shutdown of such transmission line.
6. For the following contingencies, the outage period of transmission elements, as certified by the Member Secretary, RPC, shall be excluded from the total time of the element under the period of consideration for the following contingencies:
- Outage of elements due to force majeure events beyond the control of the transmission licensee. However, whether the same outage is due to force majeure (not design failure) will be verified by the Member Secretary, RPC. A

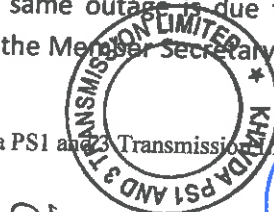

Transmission Service Agreement

reasonable restoration time for the element shall be considered by the Member Secretary, RPC, and any additional time taken by the transmission licensee for restoration of the element beyond the reasonable time shall be treated as outage time attributable to the transmission licensee. Member Secretary, RPC may consult the transmission licensee or any expert for estimation of reasonable restoration time. Circuits restored through ERS (Emergency Restoration System) shall be considered as available;

ii) Outage caused by grid incident/disturbance not attributable to the transmission licensee, e.g. faults in a substation or bays owned by another agency causing an outage of the transmission licensee's elements, and tripping of lines, ICTs, HVDC, etc., due to grid disturbance. However, if the element is not restored on receipt of direction from RLDC while normalizing the system following grid incident/disturbance within reasonable time, the element will be considered not available for the period of outage after issuance of RLDC's direction for restoration;

iii) The outage period which can be excluded for the purpose of sub-clause (i) and (ii) of this clause shall be declared as under:

- a) Maximum up to one month by the Member Secretary, RPC;
- b) Beyond one month and up to three months after the decision at RPC;
- c) Beyond three months by the Commission for which the transmission license shall approach the Commission along with reasons and steps taken to mitigate the outage and restoration timeline

7. Time frame for certification of transmission system availability: (1) The following schedule shall be followed for certification of availability by the Member Secretary of the concerned RPC:

- Submission of outage data along with documentary proof (if any) and TAFpn calculation by Transmission Licensees to RLDC/ constituents
 - By 5th of the following month;
- Review of the outage data by RLDC / constituents and forward the same to respective RPC – by 20th of the month;
- Issue of availability certificate by respective RPC – by the 3rd of the next month.

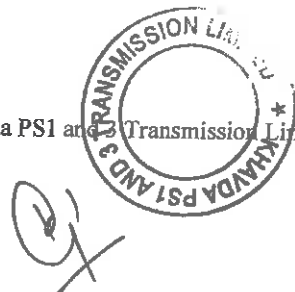
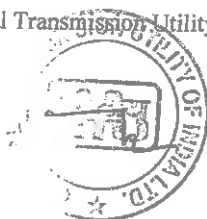

Appendix-V

FORMULAE FOR CALCULATION OF AVAILABILITY OF EACH CATEGORY OF TRANSMISSION ELEMENTS

For AC transmission system

$$AV_0(\text{Availability of } c \text{ no of AC lines}) = \frac{\sum_{k=1}^c W_k(T_k - T_{NAk})T_k}{\sum_{k=1}^c W_k}$$

$$AV_q(\text{Availability of } q \text{ no of ICTs}) = \frac{\sum_{k=1}^q W_k(T_k - T_{NAk})T_k}{\sum_{k=1}^q W_k}$$

$$AV_r(\text{Availability of } r \text{ no of SVCs}) = \frac{\sum_{k=1}^r W_k(T_k - T_{NAk})T_k}{\sum_{k=1}^r W_k}$$

$$AV_p(\text{Availability of } p \text{ no. of Switched Bus reactors}) = \frac{\sum_{k=1}^p W_k(T_k - T_{NAk})T_k}{\sum_{k=1}^p W_k}$$

$$AV_u(\text{Availability of } u \text{ no of STATCOMs}) = \frac{\sum_{k=1}^u W_k(T_k - T_{NAk})T_k}{\sum_{k=1}^u W_k}$$

$$AV_{stp}(\text{Availability of an individual HVDC pole}) = \frac{(T_x - T_N)}{T_x}$$

AV_{ybb} (Availability of an individual HVDC

$$\text{Back-to-back Blocks}) = \frac{(T_x - T_{NAx})}{T_x}$$

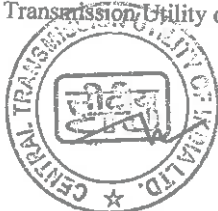

202 A20

Transmission Service Agreement

For the HVDC transmission system

For the new HVDC commissioned but not completed twelve months:

For first 12 months: $[(AV_{o,p,q,r} \text{ or } AV_{u,v,w,x,y}) \times 95\% \pm 85\%]$, subject to a ceiling of 95%.

Where

- o = Total number of AC lines
- AV_o = Availability of o number of AC lines:
- p = Total number of bus reactors switchable line reactors:
- AV_p = Availability of p number of bus reactors switchable line reactors
- q = Total number of ICTs:
- AV_q = Availability of q number of ICTs:
- r = Total number of SVCs:
- AV_r = Availability of r number of SVCs:
- U = Total number of STATCOM
- AV_u = Availability of u number of STATCOMs:
- W_i = Weightage factor for i th transmission line:
- W_k = Weightage factor for k th ICT:
- W_l = Weightage factors for inductive & capacitive operation of l th SVC:
- W_m = Weightage factor for m th bus reactor.
- W_n = Weightage factor for n th STATCOM
- $T_i, T_k, T_l, T_m, T_n, T_x, T_y$ = The total hours of i th AC line, k th ICT, l th SVC, m th Switched Bus Reactor & n th STATCOM, x th HVDC pole, y th HVDC back-to-back blocks during the period under consideration (excluding time period for outages not attributed to transmission licensee for the reasons given in Para 5 of the procedure)
- $T_{NAI}, T_{NAK}, T_{NAV}, T_{NAM}, T_{NAN}, T_{NAX}, T_{NAY}$ = The non-availability hours (excluding the time period for outages not attributed to transmission licensee taken as deemed availability as $T_{NAI}, T_{NAK}, T_{NAV}, T_{NAM}, T_{NAN}, T_{NAX}, T_{NAY}$ per Para 5 of the procedure) for i th AC line, k th ICT, l th SVC, m th Switched Bus Reactor, n th STATCOM, x th HVDC pole and y th HVDC back-to-back block

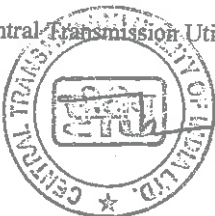

Transmission Service Agreement

Schedule: 7

Entire Bid (both financial bid and technical bid) of the Selected Bidder to be attached here

Central Transmission Utility of India Limited

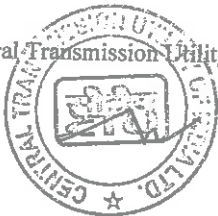

181

Khavda PS1 and 3 Transmission Limited



A handwritten signature in black ink, appearing to be a stylized 'S' or 'K' followed by a vertical line.



202 A20

Schedule: 8

Contract Performance Guarantee

(To be on non-judicial stamp paper of appropriate value as per Stamp Act relevant to place of execution. Foreign entities submitting Bids are required to follow the applicable law in their country.)

In consideration of the KHAVDA PS1 AND 3 TRANSMISSION LIMITED, Urjanidhi, First Floor, Barakhamba Lane- 1, Connaught Place, New Delhi, Central Delhi-110001 behalf of the TSP, or Lead Member in case of the Consortium, with address] agreeing to undertake the obligations under the Transmission Service Agreement dated..... and the other RFP Project Documents and the Nodal Agency and the PFC Consulting Limited, agreeing to execute the RFP Project Documents with the Selected Bidder, regarding setting up the Project, the[Insert name and address of the bank issuing the guarantee and address of the head office] (hereinafter referred to as "Guarantor Bank") hereby agrees unequivocally, irrevocably and unconditionally to pay to (being the Nodal Agency) _at[Insert the Place from the address of the Nodal Agency indicated in the TSA] forthwith on demand in writing from the Nodal Agency or any Officer authorized by it in this behalf, any amount up to and not exceeding Rupees Crores (Rs.) only [Insert the amount of the bank guarantee] on behalf of M/s. KHAVDA PS1 AND 3 TRANSMISSION LIMITED.

This guarantee shall be valid and binding on the Guarantor Bank up to and includingand shall not be terminable by notice or any change in the constitution of the Bank or the term of the Transmission Service Agreement or by any other reasons whatsoever and our liability hereunder shall not be impaired or discharged by any extension of time or variations or alternations made, given, or agreed with or without our knowledge or consent, by or between parties to the respective agreement.

Our liability under this Guarantee is restricted to Rs. Crores (Rs.) only. Our Guarantee shall remain in force until ... [Insert the date of validity of the Guarantee as per Article of this Agreement]. The Nodal Agency, shall be entitled to invoke this Guarantee up to three hundred sixty five (365) days of the last date of the validity of this Guarantee.

The Guarantor Bank hereby expressly agrees that it shall not require any proof in addition to the written demand from (in its roles as the Nodal Agency), made in any format, raised at the above mentioned address of the Guarantor Bank, in order to make the said payment to Nodal Agency.

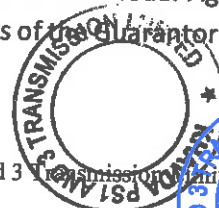

Handwritten signature or initials.

Transmission Service Agreement

The Guarantor Bank shall make payment hereunder on first demand without restriction or conditions and notwithstanding any objection by [Insert name of the Selected Bidder], [Insert name of the TSP] and / or any other person. The Guarantor Bank shall not require Nodal Agency to justify the invocation of this BANK GUARANTEE, nor shall the Guarantor Bank have any recourse against Nodal Agency in respect of any payment made hereunder.

THIS BANK GUARANTEE shall be interpreted in accordance with the laws of India.

The Guarantor Bank represents that this BANK GUARANTEE has been established in such form and with such content that it is fully enforceable in accordance with its terms as against the Guarantor Bank in the manner provided herein.

THIS BANK GUARANTEE shall not be affected in any manner by reason of merger, amalgamation, restructuring, liquidation, winding up, dissolution or any other change in the constitution of the Guarantor Bank.

THIS BANK GUARANTEE shall be a primary obligation of the Guarantor Bank and accordingly Nodal Agency shall not be obliged before enforcing this BANK GUARANTEE to take any action in any court or arbitral proceedings against **KHAVDA PS1 AND 3 TRANSMISSION LIMITED** or the Selected Bidder, as the case may be, to make any claim against or any demand on **KHAVDA PS1 AND 3 TRANSMISSION LIMITED** or the Selected Bidder, as the case may be, or to give any notice to **KHAVDA PS1 AND 3 TRANSMISSION LIMITED** or the Selected Bidder, as the case may be, or to enforce any security held by the Nodal Agency or to exercise, levy or enforce any distress, diligence or other process against **KHAVDA PS1 AND 3 TRANSMISSION LIMITED** or the Selected Bidder, as the case may be.

The Guarantor Bank acknowledges that this BANK GUARANTEE is not personal to Nodal Agency and may be assigned, in whole or in part, (whether absolutely or by way of security) by Nodal Agency to any entity to whom the Nodal Agency is entitled to assign its rights and obligations under the Transmission Service Agreement.

The Guarantor Bank hereby agrees and acknowledges that Nodal Agency shall have a right to invoke this Bank Guarantee either in part or in full, as it may deem fit.

Notwithstanding anything contained hereinabove, our liability under this Guarantee is restricted to Rs. Crores (Rs....) only and it shall remain in force until[Date to be inserted on the basis of Article 3.1.2of the Transmission Service Agreement], with an additional claim period of three hundred sixty five (365) days thereafter. This BANK GUARANTEE shall be extended from time to time for such period, as may be desired by "KHAVDA PS1 AND 3 TRANSMISSION LIMITED". We are liable to pay the guaranteed amount or any part thereof under this Bank Guarantee only if Nodal Agency serves upon us written claim or demand.

Central Transmission Utility of India Limited

183

Khavda PS1 and 3 Transmission Limited

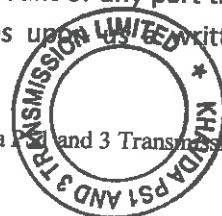

Handwritten signature or initials.

203 A99

Transmission Service Agreement

In witness where of:

Signature

Name:

Power of attorney No.:

For:

..... [Insert Name of the Bank]

Banker's Seal and Full Address, including mailing address of the Head Office

Central Transmission Utility of India Limited

184

Khavda PS1 and 2 Transmission Limited

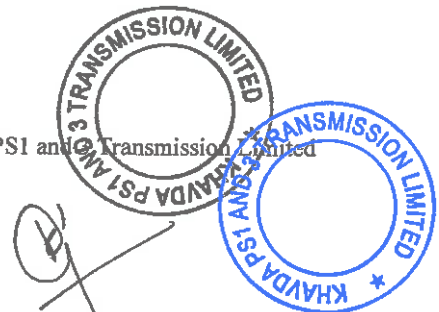

203A23

Schedule: 9

Methodology for determining the Relief Under Force Majeure Event & Change in Law during Construction Period

The relief in the form of revision in tariff due to Force Majeure Event leading to extension of Scheduled COD for a period beyond one hundred eighty (180) days and/ or Change in Law during the construction period shall be as under:

$$\Delta T = [(P \times d)] \div [1 - (1 + d)^{-n}]$$

Where,

ΔT = Change in Transmission Charges for each year

P = Sum of cumulative increase or decrease in the cost of the Project due to Change in Law and interest cost during construction corresponding to the period exceeding one hundred eighty (180) due to Force Majeure Event leading to extension of Scheduled COD for a period beyond one hundred eighty (180) days

n = number of years over which the Transmission Charges has to be paid

d = Discount rate as notified by the CERC, applicable on the Bid Deadline

The increase in Transmission Charges as stated above shall be applicable only if the value of increase in Transmission Charges as calculated above exceeds 0.30% (zero point three percent) of the quoted Transmission Charges of the TSP.

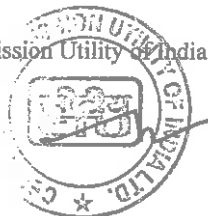

SLD

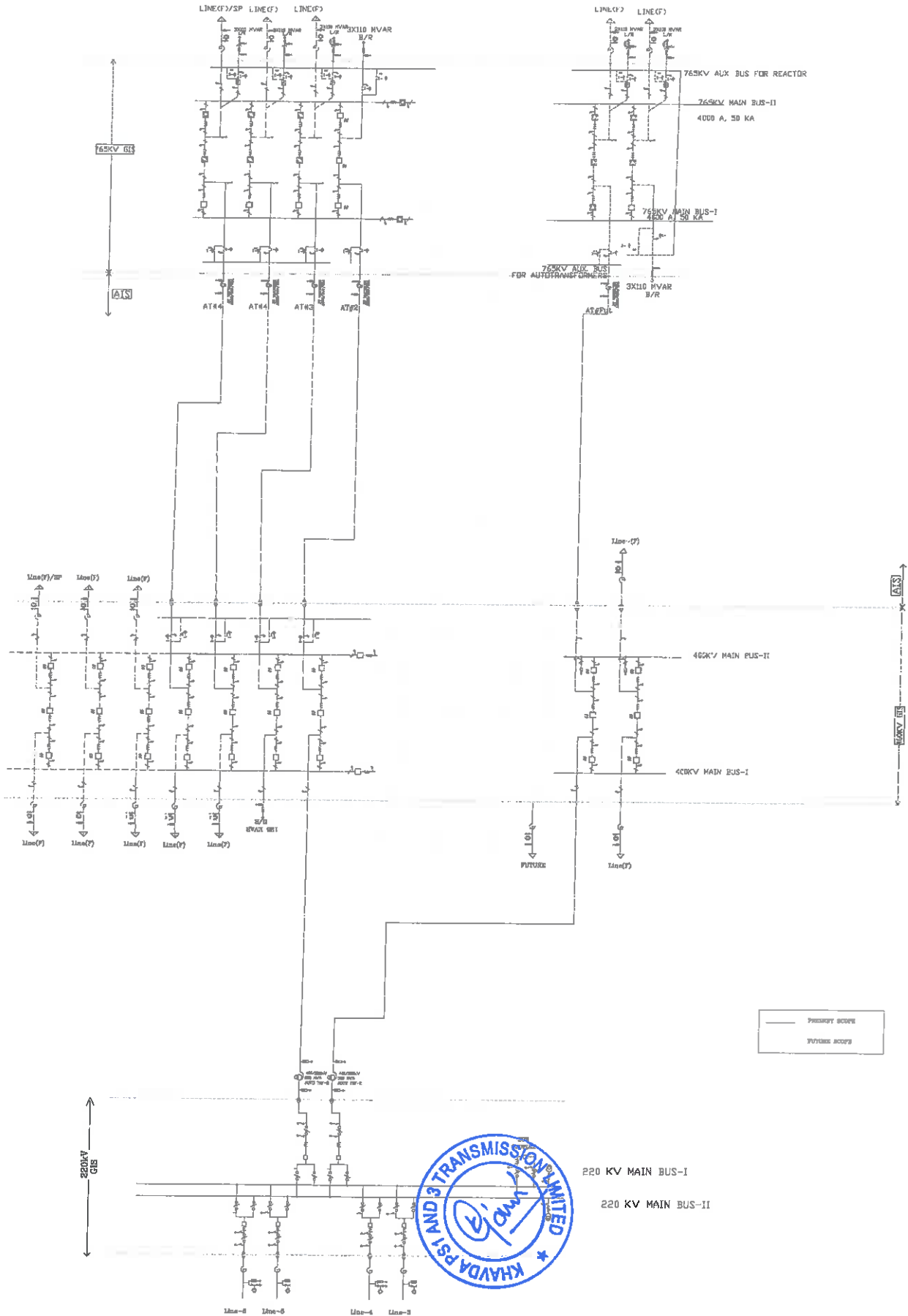

220 KV MAIN BUS-I
220 KV MAIN BUS-II

209

1. Particulars of the Applicant

Sl No	Particulars	Particulars
I	Name of the Applicant	Khavda PS1 and 3 Transmission Limited
II	Status	Public Limited Company
III	Address	B-9, Qutab Institutional Area, Katwaria Sarai, New Delhi 110 016
IV	Name, Designation & Address of the contact person	Ms. Khushboo Jain Finance Incharge, Khavda PS1 and 3 Transmission Limited (100% wholly owned subsidiary of Power Grid Corporation of India Limited) C/o Shri Pankaj Pandey ED (TBCB) Power Grid Corporation of India Limited Saudamini, Plot no.2, Sector -29, Gurgaon 122001
V	Contact Tele. No.	Ms. Khushboo Jain - 9729021199 Shri Pankaj Pandey - 9910378037
VI	Fax No.	0124-2822062
VII	Email ID	tbcb@powergrid.co.in ppandey@powergrid.in khushboojain@powergrid.in cctbcb@powergrid.in
VIII	Place of Incorporation / Registration	New Delhi, India
IX	Year of Incorporation / Registration	2023
X	Copies of the following documents are enclosed:	
a.	Certificate of Registration	Enclosed as Enclosure 1
b.	Copy of Power of Attorney	Enclosed as Enclosure 3

2. Particulars of the Project:

(a) Sub-stations :

S.No	Name of substation	Voltage Level	Transformer	Reactive Compensation	STATCOM	No of bays
1.	KPS-1 (Bus Section-I)	400kV			± 300 MVAR STATCOM with 1x125 MVAR MSC, 2x125 MVAR MSR	400kV GIS bay- 1 no.



205

2.	KPS-1 (Bus Section-II)	400kV			± 300 MVAR STATCOM with 1x125 MVAR MSC, 2x125 MVAR MSR	400kV GIS bay- 1 no.
3.	KPS-3 (Bus Section-I)	400kV			± 300 MVAR STATCOM with 1x125 MVAR MSC, 2x125 MVAR MSR	400kV GIS bay- 1 no.

- a) Remarks: Application is being filed for grant of a fresh license
b) Scheduled COD: 24 months from date of acquisition i.e. 07.11.2024
c) Ageements with CTU (Nodal Agency) for the Project: Transmission Service Agreement (TSA) is enclosed as Annexure-6 to the application

3. **Quoted transmission charges** : Rs. 1077.25 millions per annum

4. (a) Approval of Central Government as per Electricity (Transmission System Planning, Development and Recovery of Inter-state Transmission Charges) Rules, 2021 } Copy of Gazettee notification is enclosed as Annexure-1 to the application

(b) Evaluation report (if made public) by the Bid Process Coordinator } Certificate of Bid Evaluation Committee as furnished by BPC is enclosed as Enclosure-2



206

5. List of documents enclosed:

- a) Certificate of Registration, MoA & AoA: Enclosure-1
- b) Certificate of Bid Evaluation Committee as furnished by BPC: Enclosure-2
- c) Copy of Power of Attorney: Enclosure-3

Signature of the Applicant

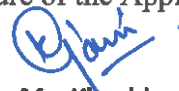

Represented by Ms. Khushboo Jain

Date: 07/11/2024
Place: New Delhi



207

૧. અરજદાર ની વિગત :

ક્રમ	વિગત	વિગત
૧	અરજદાર નું નામ	KPS1 અને ૩ ટ્રાન્સમિશન લીમીટેડ
૨	હોદ્દો	જાહેર નિમિત કંપની
૩	સરનામું	બી-૯, કુતાબ ઇન્સ્ટીટ્યુશન એરિયા, કત્વરિયા સરાઈ, નવી દિલ્હી-૧૧૦૦૧૬
૪	સંપર્ક કરનાર વ્યક્તિ નું નામ, સરનામું અને હોદ્દો	કુ. ખુશ્બુ જૈન ફાયનાન્સ ઈન્ચાર્જ, KPS1 અને ૩ ટ્રાન્સમિશન લિમિટેડ (પાવર િડ કોર્પોરેશન ઓફ ઈન્ડિયા લિમિટેડની ૧૦૦% સંપૂર્ણ માલિકીની પેટાકંપની) C/o શ્રી પંકજ પાંડે ED (TBCB) પાવર િડ કોર્પોરેશન ઓફ ઈન્ડિયા લિમિટેડ સૌદામિની, પ્લોટ નં.૨, સેક્ટર-૨૯, ગુડગાંવ ૧૨૨૦૦૧
૫	સંપર્ક નંબર	કુ. ખુશ્બુ જૈન - 9729021199 શ્રી પંકજ પાંડે - 9910378037
૬	ફેક્સ નંબર	૦૧૨૪-૨૮૨૨૦૬૨
૭	ઈ-મેલ આઈ.ડી.	tbcB@powergrid.co.in ppandey@powergrid.in khushboojain@powergrid.in cctbcB@powergrid.in
૮	નિગમ / નોંધણી નું સ્થળ	નવી દિલ્હી, ભારત

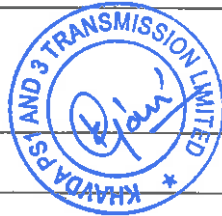

૯	નિગમ / નોંધણી નું વર્ષ	2023
10	નીચે મુજબ ના આધારો સામેલ રાખેલ છે.	
અ	નોંધની નું પ્રમાણપત્ર	બીડાણ ૧ મુજબ
બ	પાવર ઓફ એટોરની ની નકલ	બીડાણ ૩ મુજબ

૨. પ્રોજેક્ટ ની વિગત :

(અ) સબ-સ્ટેશન :

ક્રમ	સબ સ્ટેશન નું નામ	વોલ્ટેજ લેવલ	ટ્રાન્સફોર્મર	પ્રતિક્રિયા શીલ વળતર	સ્ટેટકોમ	ખાડીઓની સંખ્યા
૧	KPS-1 (બસ વિભાગ-I)	400 કે.વી.			± 300 MVAR સ્ટેટકોમ 1x125 MVAR MSC, 2x125 MVAR MSR સાથે	400kV GIS ખાડી- 1 નં.
૨	KPS-1 (બસ વિભાગ-II)	400 કે.વી.			± 300 MVAR સ્ટેટકોમ 1x125 MVAR MSC, 2x125 MVAR MSR સાથે	400kV GIS ખાડી- 1 નં.
૩	KPS-3 (બસ વિભાગ-I)	400 કે.વી.			± 300 MVAR સ્ટેટકોમ 1x125 MVAR MSC, 2x125 MVAR MSR સાથે	400kV GIS ખાડી- 1 નં.

અ) ટિપ્પણી: નવેસરથી લાઇસન્સ આપવા માટે અરજી દાખલ કરવામાં આવી રહી છે

બ) અનુસૂચિત સમાપ્ત તારીખ : સંપાદનની તારીખથી 24 મહિના એટલે કે 07.11.2024

સી) પ્રોજેક્ટ માટે સી.ટી.યુ. (નોડલ એજન્સી) સાથેના કરારો: ટ્રાન્સમિશન સર્વિસ એગ્રીમેન્ટ (ટી.એસ.એ.) અરજી સાથે જોડાણ-6 તરીકે જોડાયેલ છે.

૨૦૧

૩. અવતરિત ટ્રાન્સમિશન શુલ્ક: રૂ. વાર્ષિક ૧૦૭૭.૨૫ મિલિયન

૪ (અ) વીજળી (ટ્રાન્સમિશન સિસ્ટમ પ્લાનિંગ,
ડેવલપમેન્ટ એન્ડ રિકવરી ઓફ ઇન્ટર-સ્ટેટ
ટ્રાન્સમિશન યાર્જિસ) નિયમો, ૨૦૨૧ મુજબ
કેન્દ્ર સરકારની મંજૂરી

ગ્રેડેટ નોટિફિકેશનની નકલ
અરજી સાથે પરિશિષ્ટ-૧ તરીકે
જોડાયેલ છે

(બ) ભાવ ભરવાની પ્રક્રિયા સંયોજક દ્વારા
મૂલ્યાંકન અહેવાલ (જો જાહેર કરવામાં આવે તો).

બીપીસી દ્વારા આપવામાં આવેલ
બિડ મૂલ્યાંકન સમિતિનું
પ્રમાણપત્ર બિડાણ-૨ તરીકે
જોડાયેલ છે

૫. સામેલ દસ્તાવેજોની સૂચિ:

- નોંધણીનું પ્રમાણપત્ર, MoA&AoA: બિડાણ-૧ થી મૂળ અરજી
- બીપીસી દ્વારા આપવામાં આવેલ ભાવ ભરવાની પ્રક્રિયા મૂલ્યાંકન સમિતિનું પ્રમાણપત્ર: બિડાણ-૨ થી મૂળ અરજી
- પાવર ઓફ એટર્નીની નકલ: બિડાણ -૩

અરજદારની સહી

પુશ્પુ જૈન દ્વારા પ્રતિનિધિત્વ કરવામાં આવ્યું હતું

Pank

તારીખ: ૦૭/૧૧/૨૦૨૫
સ્થળ: નવી દિલ્હી



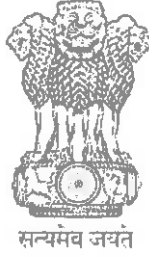

**GOVERNMENT OF INDIA
MINISTRY OF CORPORATE AFFAIRS**

Central Registration Centre

Certificate of Incorporation

[Pursuant to sub-section (2) of section 7 and sub-section (1) of section 8 of the Companies Act, 2013 (18 of 2013) and rule 18 of the Companies (Incorporation) Rules, 2014]

I hereby certify that KHAVDA PS1 AND 3 TRANSMISSION LIMITED is incorporated on this TWENTY SECOND day of DECEMBER TWO THOUSAND TWENTY THREE under the Companies Act, 2013 (18 of 2013) and that the company is Company limited by shares

The Corporate Identity Number of the company is **U42201DL2023GOI424248**

The Permanent Account Number (PAN) of the company is **AAKCK7101R***

The Tax Deduction and Collection Account Number (TAN) of the company is **DELK27278G***

Given under my hand at Manesar this TWENTY SECOND day of DECEMBER TWO THOUSAND TWENTY THREE



Signature Not Verified

Digitally signed by
DS MINISTRY OF CORPORATE
AFFAIRS 10
Date: 2023.12.22 13:20:42 IST

Dr Rameshkumar

Assistant Registrar of Companies/ Deputy Registrar of Companies/ Registrar of Companies

For and on behalf of the Jurisdictional Registrar of Companies

Registrar of Companies

Central Registration Centre

Disclaimer: This certificate only evidences incorporation of the company on the basis of documents and declarations of the applicant(s). This certificate is neither a license nor permission to conduct business or solicit deposits or funds from public. Permission of sector regulator is necessary wherever required. Registration status and other details of the company can be verified on mca.gov.in

Mailing Address as per record available in Registrar of Companies office:

KHAVDA PS1 AND 3 TRANSMISSION LIMITED

Urjanidhi, First Floor, Barakhamba Lane- 1, Connaught Place, New Delhi, Central Delhi- 110001, Delhi

*as issued by Income tax Department



Form No. INC-33



Form language

English Hindi

e-MOA (e-Memorandum of Association)

[Pursuant to Schedule I (see Sections 4 and 5) to the Companies Act, 2013]

Refer instruction kit for filling the form

All fields marked in * are mandatory

*** Table applicable to company as notified under schedule I of the Companies Act, 2013**

- (A - MEMORANDUM OF ASSOCIATION OF A COMPANY LIMITED BY SHARES
- B - MEMORANDUM OF ASSOCIATION OF A COMPANY LIMITED BY GUARANTEE AND NOT HAVING A SHARE CAPITAL
- C - MEMORANDUM OF ASSOCIATION OF A COMPANY LIMITED BY GUARANTEE AND HAVING A SHARE CAPITAL
- D - MEMORANDUM OF ASSOCIATION OF AN UNLIMITED COMPANY AND NOT HAVING SHARE CAPITAL
- E - MEMORANDUM OF ASSOCIATION OF AN UNLIMITED COMPANY AND HAVING SHARE CAPITAL)

A - MEMORANDUM OF ASSOCIATION OF A COMPANY LIMITED BY SHARES

Table A/B/C/D/E

1 The name of the company is

KHAVDA PS1 AND 3 TRANSMISSION LIMITED

2 The registered office of the company will be situated in the State of

Delhi

3 (a) The objects to be pursued by the company on its incorporation are:

1. To develop Power System Network
To plan, promote and develop an integrated and efficient power transmission system network in all its aspects including planning, investigation, research, design and engineering, preparation of preliminary, feasibility and definite project reports, construction, operation and maintenance of transmission lines, sub-stations, load dispatch stations and communication facilities and appurtenant works, coordination of integrated operation of state, regional and national grid system, execution of turn-key jobs for other utilities/organizations and wheeling of power in accordance with the policies, guidelines and objectives laid down by the Central Government from time to time.
2. To study, investigate, collect information and data
To study, investigate, collect information and data, review operation, plan, research, design and prepare Report, diagnose

ATTESTED TRUE COPY
Attested from Pg 212 - Pg 225

Authorized Signatory
KHAVDA PS1 AND 3 TRANSMISSION LIMITED



212

operational difficulties and weaknesses and advise on the remedial measures to improve, undertake development of new and innovative product connected with business of the Company as well as modernize existing EHV, HV lines and Sub-Stations.

3. To act as Consultants/ Technical Advisers of public/ private sector enterprises etc.

To act as consultants, technical advisors, surveyors and providers of technical and other services to Public or Private Sector enterprises engaged in the planning, investigation, research, design and preparations of preliminary, feasibility and definite project reports, manufacture of power plant and equipment, construction, generation, operation and maintenance of power transmission system from power generating stations and projects, transmission, distribution and sale of power.

(b) *Matters which are necessary for furtherance of the objects specified in clause 3(a) are

1. To obtain authority etc. to carry out its objects
To obtain license, approvals and authorization from Governmental Statutory and Regulatory Authorities, as may be necessary to carry out and achieve the Objects of the Company and connected matters which may seem expedient to develop the business interests of the Company in India and abroad.

2. To obtain charters, concession etc.

To enter into any arrangement with the Government of India or with any State Government or with other authorities/ commissions, local bodies or public sector or private sector undertakings, Power Utilities, Financial Institutions, Banks, International Funding Agencies and obtain such charters, subsidies, loans, advances or other money, grants, contracts, rights, sanctions,



213

privileges, licenses or concessions whatsoever (whether statutory or otherwise) which the Company may think it desirable to obtain for carrying its activities in furthering the interests of the Company or its members.

3. To enter into Implementation/ Construction Agreement

To enter into any agreement, contract or any arrangement for the implementation of the power generation, evacuation, transmission and distribution system and network with Power/ Transmission Utilities, State Electricity Boards, Vidyut Boards, Transmission Companies, Generation Companies, Licensees, Statutory bodies, other organizations (whether in Private, Public or Joint Sector Undertaking) and bulk consumers of power etc.

4. To carry on the business or purchasing, importing, exporting and trading power

To carry on the business or purchasing, importing, exporting and trading of power subject to the provisions of Electricity Act, 2003 and to supply electric power generated by other plants to distribution companies, trading companies, other generation companies and other Persons, and in this regard execute agreements with Central and State generating authorities, departments or companies, Independent Power Producers and other Persons.

5. To enter into Agreements; etc.

To secure the payments of money, receivables on transmission and distribution of electricity and sale of fuel, as the case may be, to the State Electricity Boards, Vidyut Boards, Transmission Utilities, Generating Companies, Transmission Companies, Distribution Companies, State Governments, Licensees, statutory bodies, other organizations (whether in Private, Public or Joint Sector Undertaking) and bulk



consumers of power etc. through Letter of Credits/ESCROW and other security documents.

6. To execute transmission service Agreements

To execute Transmission Service Agreements or other agreements for transmission of power to distribution, trading, and other companies, State Electricity Boards, State Utilities and any other organization and Persons.

7. To co-ordinate with Central Transmission Utility
To coordinate with the Central Transmission Utility for transmission of electricity under the provisions of Electricity Act 2003.

8. To borrow money
Subject to provisions of Sections 73, 179, 180 and other applicable provisions of the Companies Act, 2013 and subject to other laws or directives, if any, of SEBI/RBI, to borrow money in Indian rupees or foreign currencies and obtain foreign lines of credits/ grants/aids etc. or to receive money or deposits from public for the purpose of the Company's business in such manner and on such terms and with such rights, privileges and obligations as the Company may think fit. The Company may issue bonds/ debentures whether secured or unsecured; bills of exchange, promissory notes or other securities, mortgage or charge on all or any of the immovable and movable properties, present or future and all or any of the uncalled capital for the time being of the Company as the Company may deem fit and to repay, redeem or pay off any such securities or charges.

9. To lend money
To lend money on property or on mortgage of immovable properties or against Bank guarantee and to make advances of money against future supply of goods and services on such terms as the Directors may consider necessary and to invest money of the Company in such



manner as the Directors may think fit and to sell, transfer or to deal with the same.

10. To acquire, own, lease or dispose off the property

To own, possess, acquire by purchase, lease or otherwise rights, title and interests in and to, exchange or hire real estate, equipment, Transmission lines, lands, buildings, apartments, plants, equipment, machinery, fuel blocks and hereditaments of any tenure or descriptions situated in India or abroad or any estate or interest therein and any right over or connected with land so situated and turn the same to account in any manner as may seem necessary or convenient for the purpose of business of the Company and to hold, improve, exploit, re-organize, manage, lease, sell, exchange or otherwise dispose of the whole or any part thereof.

11. To deal in Scrips/Govt. Securities

Subject to applicable provisions of law, to subscribe for, underwrite, or otherwise acquire, hold, dispose of and deal with the shares, stocks, debentures or other securities and titles of indebtedness or the right to participate in profits or other similar documents issued by any Government authority, Corporation or body or by any company or body of persons and any option or right in respect thereof.

12. To create funds and appropriate profits

To create any depreciation fund, reserve fund, sinking fund, insurance fund, gratuity, provident fund or any other fund, for depreciation or for repairing, improving extending or maintaining any of the properties of the Company or for any other purposes whatsoever conducive to the interests of the Company.

13. To purchase or otherwise acquire companies
To acquire shares, stocks, debentures or securities of any company carrying on any



business which this Company is entitled to carry on or acquisition of undertaking itself which may seem likely or calculated to promote or advance the interests of the Company and to sell or dispose of or transfer any such shares, stocks or securities and the acquired undertaking.

14. To enter into partnership Agreement or Merge / amalgamate

To enter into partnership or into any agreement for joint working, sharing or pooling profits, joint venture, amalgamation, union of interests, co-operation, reciprocal concessions or otherwise or amalgamate with any person or company carrying on or engaged in or about to carry on or engaged in any business or transaction in india or abroad which the Company is authorized to carry on or engage in any business undertaking having objects identical or similar to, as are being carried on by this Company.

15. To have agencies and branch offices in India and abroad

To establish and maintain agencies, branch offices and local agencies, to procure business in any part of India and world and to take such steps as may be necessary to give the Company such rights and privileges in any part of the world as deemed proper in the interest of the Company.

16. To promote institutions or other companies

To promote and undertake the formation of any institution or Company or subsidiary company or for any aforesaid objects intended to benefit the Company directly or indirectly and to coordinate, control and guide their activities.

17(a) To acquire know how and import-export of machinery and tools etc.

To negotiate and enter into agreements and contracts with domestic and foreign companies, persons or other organizations,



217

banks and financial institutions, in relation to the business of the Company including that of technical know-how, import, export, purchase or sale of plant, machinery, equipment, tools, accessories and consumables, financial assistance and for carrying out all or any of the objects of the Company.

17(b) To negotiate and enter into agreements etc.

To negotiate and enter into agreements and contracts for execution of turnkey jobs, works, supplies and export of plant, machinery, tools and accessories etc.

18. To enter into contracts/arrangements in connection with issue of shares/securities. Upon and for the purpose of any issue of shares, debentures or any other securities of the Company, to enter into agreement with intermediaries including brokers, managers of issue/commission agents and underwriters and to provide for the remuneration of such persons for their services by way of payment in cash or issue of shares, debentures or other securities of the Company or by granting options to take the same or in any other manner as permissible under the law.

19. To enter into contracts of indemnity and/or guarantee
To enter into contracts of indemnity and get guarantee and allocations for the business of the Company.

20. To arrange for Training and Development

To make arrangements for training of all categories of employees and to employ or otherwise engage experts, advisors, consultants etc. in the interest of achieving the Company's objects.

21. To promote conservation, protect environment, theft etc.

To promote conservation and protection of electricity from theft, safety of life and to protect environments including air, land



and water etc.

22. To provide for welfare of employees

To pay and provide for the remuneration, amelioration and welfare of persons employed or formerly employed by the Company and their families providing for pension, allowances, bonuses, other payments or by creating for the purpose from time to time the Provident Fund, Gratuity and other Funds or Trusts. Further to undertake building or contributing to the building or houses, dwellings or chawls by grants of money, or by helping persons employed by the Company to effect or maintain insurance on their lives by contributing to the payment of premium or otherwise and by providing or subscribing or contributing towards educational institutions, recreation, hospitals and dispensaries, medical and other assistance as the Company may deem fit.

23. To take Insurance

To ensure any rights, properties, undertakings, contracts, guarantees or obligations or profits of the Company of every nature and kind in any manner with any person, firm, association, institution or company.

24. To share the profits pay, dividends and provide bonus etc

To distribute among members of the Company dividend including bonus shares out of profits, accumulated profits or funds and resources of the Company in any manner permissible under law.

25. To institute and defend the legal proceedings

To institute, conduct, defend, compound or abandon any legal proceedings by or against the Company or its officers or otherwise concerning the affairs of the Company and also to compound and to allow time for payment or satisfaction of any debts or recovery due, claims or demands by or against the



219

Company and to refer any claims or demands by or against the Company or any differences arising in execution of contracts to conciliation and arbitration and to observe, comply with and/or challenge any awards preliminary, interim or final made in any such arbitration.

26. To pay and subsequently write off preliminary expenses

To pay out of the funds of the Company all costs, charges, expenses and preliminary and incidental to the promotion, formation, establishment and registration of the Company or other expenses incurred in this regard.

27. To contribute and make donations

Subject to provisions of Companies Act, 2013 to contribute money or otherwise assist to charitable, benevolent, religious, scientific national, defense, public or other institutions or objects or purposes.

28. To open accounts in Banks

To open an account or accounts with any individual, firm or company or with any bank bankers or shrofs and to pay into and withdraw money from such account or accounts.

29. To accept gifts, donations etc.

To accept gifts, bequests, devises and donations from members and others and to make gifts to members and others of money, assets and properties of any kind.

30. To pursue the objects of the Company as principal, agents, trustee or in any other capacity

To carry out all or any of the objects of the company and do all or any of the above things in any part of the world and either as principal, agent, contractor or trustee or otherwise and either alone or in conjunction with others.

31. To enter Into Contracts To negotiate and/or enter into agreement and contract with



220

individuals, companies, corporations, foreign or Indian, for obtaining or providing technical, financial or any other assistance for carrying on all or any of the objects of the Company and also for the purpose of activating, research, development of projects on the basis of know-how and/or financial participation and for technical collaboration, and to acquire or provide necessary formulate and patent rights for furthering the objects of the company.

32. To contribute towards promotion of trade and industry To aid pecuniary or otherwise, any association, body or movement having for its object the solution, settlement or surmounting of industrial or labour problems or trouble or the promotion of industry or trade.

33. To take all necessary steps for winding up of the company

Subject to the provisions of Companies Act, 2013 or any amendment or re-enactment thereof in the event of winding up to distribute among the members in specie any property of the Company or any proceeds of sale on disposal of any property in accordance with the provisions of the Act.

34. To do and perform all coincidental and ancillary acts for the attainment of its objects

To do all such other things as may be deemed incidental or conducive to the attainment of the above Objects or any of them and to carry on any business which may seem to the Company capable of being conveniently carried in connection with any of the Company's Objects or calculated directly or indirectly to enhance the value of or render profitable any of the Company's property or rights.

35. To take up studies and research experiments. To establish, provide, maintain and conduct or otherwise



subsidies research laboratories and experimental workshops for scientific, technical or researches, experiments and to undertake and carry on directly or in collaboration with other agencies scientific and technical research experiments and tests of all kinds and to process, improve and invent new products and their techniques of manufacture and to promote, encourage, reward in every manner studies and research, scientific and technical investigations and inventions of any kind that may be considered likely to assist, encourage and promote rapid advances in technology, economies, import substitution or any business which the Company is authorized to carry on.

36. To evolve scheme for restructuring or arrangement. Subject to provisions of the Companies Act, 2013, to evolve scheme for restructuring or arrangement, to amalgamate or merge or to enter into partnership or into any consortium or arrangement for sharing of profits, union of interests, co-operation, joint venture with any Person or Persons, partnership firm/firms, or company or companies carrying on or engaged in any operation capable of being conducted so conveniently in co-operation with the business of the Company or to benefit the Company or to the activities for which the Company has been established.

37. To apply for purchase, or otherwise acquire. To apply for purchase, or otherwise acquire any trademarks, patents, brevets, inventions, licenses, concessions and the like, conferring any exclusive or nonexclusive or limited rights to use, or any secret or other information as to any invention which may be capable of being used for any of the purposes of the Company, or the acquisition of which may benefit the Company and to use,



222

exercise, develop or grant licenses in respect of or otherwise turn to account the property, rights or information so acquired.

38. To sell, dispose or give off an undertaking of the Company

To sell, dispose or give off an undertaking of the Company or any part thereof for such consideration as the Company may think fit and in particular for shares, debentures or securities of any other association, corporation or company.

39. To sell, improve, manage, develop
To sell, improve, manage, develop, exchange, loan, lease or let, under-lease, sub - let, mortgage, dispose of, deal with in any manner, turn to account or otherwise deal with any rights or property of the Company.

40. To outsource parts of its activities
To outsource parts of its activities to achieve higher efficiencies and throughputs in the achievement of its business goals.

4 The liability of the member(s) is limited, and this liability is limited to the amount unpaid if any, on the shares held by them.

The liability of the member(s) is limited

The liability of the member(s) is Unlimited

5 Every member of the company undertakes to contribute:

(i) to the assets of the company in the event of its being wound up while he is a member, or within one year after he ceases to be a member, for payment of the debts and liabilities of the company or of such debts and liabilities as may have been contracted before he ceases to be a member; and

(ii) to the costs, charges and expenses of winding up (and for the adjustment of the rights of the contributories among themselves), such amount as may be required, not exceeding * _____ rupees.

(iii) The share capital of the company is 100000 rupees, divided into

10000	Equity Share	Shares of	10	Rupees each	
-------	--------------	-----------	----	-------------	--



223

6

We, the several persons, whose names and address are subscribed, are desirous of being formed into a company in pursuance of this memorandum of association, and we respectively agree to take the number of shares in the capital of the company set against our respective names:

I, whose name and address is given below, am desirous of forming a company in pursuance of this memorandum of association and agree to take all the shares in the capital of the company:

We, the several persons, whose names and addresses are subscribed, are desirous of being formed into a company in pursuance of this memorandum of association:

Subscriber Details

S. No.	*Name, Address, Description and Occupation	DIN / PAN / Passport number	No. of shares taken	DSC	Dated
1	RISHAB JAIN S/o Sh. Naveen Jain R/o T-11, first floor, Green Park Extension, New Delhi, 110016 (As a Nominee of PFC Consulting Limited) Occupation:- Service	08485361	100 Equity,0 Preference	Rishab Jain <small>Digitally signed by Rishab Jain Date: 2023.12.18 18:06:02 +05:30</small>	18/12/2023
2	NEERAJ SINGH S/o Sh. Dayashankar Singh R/o Flat C-703, The Crescent Apartment, Plot F-2, Sector-50, Noida, Gautam Budh Nagar, UP-201301 (As a Nominee of PFC Consulting Limited) Occupation:- Service	08613892	100 Equity,0 Preference	Neeraj Singh <small>Digitally signed by Neeraj Singh Date: 2023.12.18 12:18:48 +05:30</small>	18/12/2023
3	M/s PFC Consulting Limited having its registered office at Urjanidhi, 1, Barakhamba Lane, Connaught Place, New Delhi-110001 Through Sh. Sachin Arora S/o Sh. Prem Lal Arora R/o F5 1903, Supertech Eco Village 1, Near Park, Greater Noida ? 201301 (as authorized representative of PFC Consulting Limited)	AKGPA1434J	9400 Equity,0 Preference	Sachin Arora <small>Digitally signed by Sachin Arora Date: 2023.12.18 18:27:38 +05:30</small>	18/12/2023
4	SACHIN SHUKLA S/o Sh. Raj Kumar Shukla R/o 4th Floor, House No. 6, H1 Block, Good Earth City Centre, south City 2, Gurgaon - 122018 (As a Nominee of PFC Consulting Limited) Occupation:- Service	08613963	100 Equity,0 Preference	Sachin Shukla <small>Digitally signed by Sachin Shukla Date: 2023.12.18 18:08:44 +05:30</small>	18/12/2023

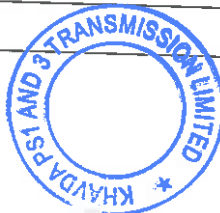

224

5	SANJAY KUMAR NAYAK S/o Sh. Jagabandhu Nayak R/o K 713, Jalvayu Tower, Sector 56 Gurgaon- Haryana 122011 (As a Nominee of PFC Consulting Limited) Occupation:- Service	08197193	100 Equity,0 Preference	Sanjay Kumar Nayak <small>Digitally signed by Sanjay Kumar Nayak Date: 2023.12.18 15:28:44 +05:30</small>	18/12/2023
6	MANOJ KUMAR RANA S/o Sh. Sube Singh R/o A-32/E, DDA Flats, Munirka, New Delhi-110067 (As a Nominee of PFC Consulting Limited) Occupation:- Service	02263302	100 Equity,0 Preference	Manoj Kumar Rana <small>Digitally signed by Manoj Kumar Rana Date: 2023.12.18 15:10:10 +05:30</small>	18/12/2023
7	MILIND MADHUSUDAN DAFADE S/o Sh. Madhusudan Gurinath Dafade R/o Aishwaryam Appt., Flat C-31, Sec-4, Plot No. 17, Dwarka, New Delhi-110078 (As a Nominee of PFC Consulting Limited) Occupation:- Service	09587967	100 Equity,0 Preference	MILIND MADHUSUDAN AN DAFADE <small>Digitally signed by Milind Madhusudan An Dafade Date: 2023.12.18 15:07:19 +05:30</small>	18/12/2023
Total shares taken			10000 Equity,0 Preference		

Signed before me

Membership type of the witness (ACA/FCA/ACS/FCS/ ACMA/FCMA)	*Name of the witness	*Address, Description and Occupation	DIN / PAN / Passport number / Membership number	DSC	Dated
FCS	Naresh Kumar Sinha	121, Vinayak Apartment, C58/19, Sector-62, Noida-201307, UP	1807	NARESH KUMAR SINHA <small>Digitally signed by NARESH KUMAR SINHA Date: 2023.12.18 15:33:28 +05:30</small>	18/12/2023

7 Shri / Smt

aged

Of

resident of

years shall be the nominee in the event of death of the sole member.



225

Form No. INC-34

e-AOA (e-Articles of Association)

[Pursuant to Section 5 of the Companies Act, 2013 and rules made thereunder read with Schedule I]



Form language

English Hindi

Refer instruction kit for filing the form.

All fields marked in * are mandatory

Table applicable to company as notified under schedule I of the Companies Act, 2013 (F, G, H)

F
F - A COMPANY LIMITED BY SHARES
KHAVDA PS1 AND 3 TRANSMISSION LIMITED

Table F / G / H (basis on the selection of above-mentioned field) as notified under schedule I of the companies Act, 2013 is applicable to
(F - a company limited by shares
G - a company limited by guarantee and having a share capital
H - a company limited by guarantee and not having share capital)

The name of the company is

KHAVDA PS1 AND 3 TRANSMISSION LIMITED

Check if not applicable	Check If altered	Article No.	Description
			Interpretation
<input type="checkbox"/>	<input checked="" type="checkbox"/>		<ul style="list-style-type: none">1. Interpretation clause In the interpretation of these Articles unless repugnant to the subject or context- Act The Act means The Companies Act 2013 as amended from time to time and includes any statutory modification or re-enactment thereof for the time being in force. Articles of the Company Articles means the articles of association of a company as originally framed or as altered from time to time or applied in pursuance of any previous company law or of this Act. Auditor(s) Auditor(s) mean and include persons appointed as such for the time being by the Comptroller Auditor General of India. Board or Board of Directors Board or Board of Directors in relation to a company means the collective body of the directors of the company. Books of Account Books of account includes records maintained in respect of (i) all sums of money received and expended by a company and matters in relation to which the receipts and expenditure take place (ii) all sales and purchases of goods and services by the company (iii) the assets and liabilities of the company and (iv) the items of cost as may be prescribed under section 148 in the case of a company which belongs to any class of companies specified under that section. Capital Capital means the share capital for the time being raised or authorized to be raised for the purpose of the Company. Company Shall means KHAVDA PS1 AND 3 TRANSMISSION LIMITED. Debenture Debenture includes debenture stock bonds or any other instrument of a company evidencing a

ATTESTED TRUE COPY

Attested from Pg 226 - Pg 268
Authorized Signatory
KHAVDA PS1 AND 3 TRANSMISSION LIMITED



226

debt whether constituting a charge on the assets of the company or not. Director(s) Director means a director appointed to the Board of a company under Section 2(34) of the Act. Dividend Dividend includes any interim dividend. Financial Institution Financial Institution includes a scheduled bank and any other financial institution defined or notified under the Reserve Bank of India Act 1934. Gender Words importing the masculine gender also include the feminine gender. Generation Company Generation Company shall mean any entity engaged in the business of generation of electricity. In Writing and Written In writing and Written include printing lithography and other modes of representing or reproducing words in a visible form. key managerial personnel key managerial personnel in relation to a company means (i) the Chief Executive Officer or the managing director or the manager (ii) the company secretary (iii) the whole-time director (iv) the Chief Financial Officer and (v) such other officer as may be prescribed. Meeting or General Meeting Meeting means Annual General Meeting or Extraordinary General Meeting of Members duly called and constituted including an adjourned meeting. In the context of Board of Directors it shall mean the meeting of the Directors including an adjourned meeting. Member Member in relation to a company means (i) the subscriber to the memorandum of the company who shall be deemed to have agreed to become member of the company and on its registration shall be entered as member in its register of members (ii) every other person who agrees in writing to become a member of the company and whose name is entered in the register of members of the company (iii) every person holding shares of the company and whose name is entered as a beneficial owner in the records of a depository. Month Month means a calendar month. Office Office means the Registered Office of the company for the time being. paid-up share capital or share capital paid-up means such aggregate amount of money credited as paid-up as is equivalent to the amount received as paid up in respect of shares issued and also includes any amount credited as paid-up in respect of shares of the company but does not include any other amount received in respect of such shares by whatever name called. Persons Persons include Corporations and firms as well as Individuals. Power Transmission Utility Power Transmission Utility shall mean any entity engaged in the business of power transmission. Proxy Proxy includes Attorney duly constituted under a valid Power of Attorney. Project-In-Charge A Director of the Company designated as Project In-charge for administering day to day activities of the Company. Public Company Public Company means a company which a. is not a private company and b. has a minimum paid-up share capital as may be prescribed. Provided that a company which is a subsidiary of a company not being a private company shall be deemed to be public company for the purposes of this Act even where such subsidiary company continues to be a private company in its articles. Registrar Registrar means a Registrar an Additional Registrar a Joint Registrar a Deputy Registrar or an Assistant Registrar having the duty of registering companies and discharging various functions under this Act. Register of Members Register of Members means the Register of Members to be kept pursuant to the Act. Related Party Section 2(76) of the Act describes related party with reference to a company which means (i) a director or his relative (ii) a key managerial personnel or his relative (iii) a firm in which a director manager or his relative is a partner (iv) a private company in which a director or manager is a member or director (v) a public company in which a director or



227

manager is a director or holds along with his relatives more than two per cent. of its paid-up share capital (vi) any body corporate whose Board of Directors managing director or manager is accustomed to act in accordance with the advice directions or instructions of a director or manager (vii) any person on whose advice directions or instructions a director or manager is accustomed to act Provided that nothing in sub-clauses (vi) and (vii) shall apply to the advice directions or instructions given in a professional capacity (viii) any company which is (A) a holding subsidiary or an associate company of such company or (B) a subsidiary of a holding company to which it is also a subsidiary (ix) such other person as may be prescribed. Seal Means the common seal of the company for the time being. Securities Exchange Board Securities and Exchange Board means the Securities and Exchange Board of India established under section 3 of the Securities Exchange Board of India Act 1992. Securities Securities means the securities as defined in clause (h) of section 2 of the Securities Contracts (Regulation) Act 1956. Share Means a share in the share capital of a company and includes stock. Share Capital Share Capital means the total equity share capital of the Company agreed to be issued and called the Authorized Capital of the Company as mentioned in the Memorandum of Association of the Company. Singular Number Words importing the singular number include where the context admits the plural number and vice-versa. State Electricity Board State Electricity Board means the Electricity Board or Vidyut Board or any other body by whatever name called set up by the State Governments under Electricity (Supply) Act 1948 as amended which expression shall include its successors administrators authorized representatives and permitted assigns. Transmission Company Transmission Company shall mean any entity engaged in the business of transmission of electricity. Year or Financial Year Meaning of Words Year means English calendar year and Financial Year shall have the meaning assigned thereto by Section 2(41) of the Act. Unless the context otherwise requires words or expressions contained in these regulations shall bear the same meaning as in the Act or any statutory modification thereof in force at the date at which these regulations become binding on the company. Marginal Notes Marginal Notes are for ease of reference only and shall not affect the construction and interpretation of these Articles. Other Expressions Other words or expressions contained in these Articles shall bear the same meaning as are assigned to them in the Act or any statutory modifications thereof. 2. Table F not to Apply The regulations contained in Table F in the First Schedule to the Companies Act 2013 shall not apply except to the extent that the same are repeated or contained or expressly made applicable by these Articles or by the Act but the regulations for the management of the Company and for the observance of the members thereof and their representatives shall be subject to any exercise of the statutory powers of the Company with reference to the repeal or alteration of or addition to its regulations by Special Resolution as prescribed by the said Companies Act 2013 be such as contained in these Articles. BUSINESS PURPOSE 3. Business Purpose The Company shall be engaged in the business of Transmission of Electricity including construction operation maintenance and other related activities.

Share Capital and Variation of rights

- 4. Share Capital Increase of capital by the Company and how carried



228

into effect The Authorized Share Capital of the Company is as mentioned in clause V of the Memorandum of Association of the Company. The Company in General Meeting may from time to time by resolution increase its authorized share capital by creation of new shares such increase to be of such aggregate amount and to be divided into shares of such respective amounts as may be determined by the General Meeting subject to the provisions of the Act. 5. New Capital same as existing capital Any capital raised by the creation of new shares shall be considered as part of the original capital and shall be subject to the same provisions herein contained with reference to the payment of calls and installments forfeiture lien surrender transfer and transmission voting and otherwise. 6. Reduction of Capital The Company may from time to time by special resolution reduce its capital which may be paid off either with or without extinguishing or reducing liability on shares which is in excess of the wants of the company or canceling such share capital which has been lost or is unrepresented by available assets. 7. Subdivision and consolidation of shares The Company in general meeting may from time to time sub-divide or consolidate its shares or any of them and exercise any of the other powers conferred by Section 61 of the Act and shall file with the Registrar such notice of exercise of any such powers as may be required by the Act. 8. Register and Index of Members Beneficial owners The Company shall cause to be kept a Register and also an Index of Members and Debenture-holders in accordance with Sections 88 of the Act. Further as permissible under Section 88 of the Act the register and index of beneficial owners maintained by a Depository shall be deemed to be the corresponding Register and Index for the purpose of this Act. 9. Foreign Register of members The Company shall be entitled to keep in any country outside India a Foreign Register of members resident in that country subject to compliance with the provisions of Section 88 of the Act. 10. Shares to be numbered distinctively The shares in the capital held otherwise than in the depository mode shall be numbered progressively in sequence and given distinctive number Except and in the manner herein mentioned no share shall be forfeited or surrendered and shall continue to bear the number which it had originally borne. 11. Share Application Money The Company shall ensure that the share application money paid is held by it in an account with a Scheduled Commercial Bank (in the name of the Company) 12. Further Issue of Capital (a) Where at any time the Company wishes to raise its subscribed share capital by issue of further shares it shall first offer such shares to its existing shareholders in proportion to their existing shareholdings on the date of such issue. Such offer to the existing shareholders shall be in accordance with the provisions of Section 62 of the Act. (b) The Company shall subject to applicable provisions of the Act and Articles of Association make uniform calls from time to time upon all the Shareholders in respect of the moneys remaining unpaid on the issued share capital within 30 days or such time as the Board may deem fit and appropriate. 13. Shares under control of Directors Subject to the provisions of these Articles and of the Act the shares including any shares forming part of any increased capital of the Company shall be under the control of the Directors who may allot or otherwise dispose off the shares to such persons in such proportion on such terms and conditions and at such times as the Directors may think fit and subject to the sanction of the Company in General Meeting subject to the provisions of Sections 52 and section 54 of the Act at a premium or par and such option being exercisable for such time and for such

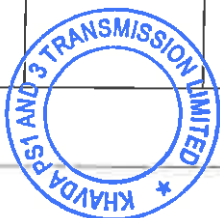

229

consideration as the Directors think fit. The Board shall cause to be filed the returns as to allotment provided for in Section 39(4) of the Act. 14. Issue of shares for consideration other than cash Subject to these Articles and the provisions of the Act if any the Board may issue and allot shares in the capital of the Company as payment or in consideration or as part payment or in part consideration of the purchase or acquisition of any property or for services rendered to the Company in the conduct of its business and shares which may be so issued or allotted shall be credited or deemed to be credited as fully paid up or partly paid up shares. 15. Power of Company to Issue Shares The Company in General Meeting may subject to the provisions of Section 42 62 of the Act provide that any shares (whether forming part of the original capital or of any increased capital of the Company) shall be offered to such persons (whether a Member or not) in such proportion and on such terms and conditions as the Act) at a premium or at par or at a discount as such General Meeting shall determine and with full power to give any person (whether a Member or not) the option to call for or be allotted shares of any class of the Company either subject to compliance with the provisions of Sections 52 and 54 of the Act at a premium or at par or at discount such option being exercisable at such times and for such consideration as may be directed by such General Meeting or the Company in General Meeting may make any other provisions whatsoever for the issue allotment or disposal of any shares. 16. Acceptance of shares Any person applying for shares in the Company followed by an allotment of any shares and subscribers to the Memorandum shall be a shareholder within the meaning of these Articles and every person whose name is on the Register of Members shall for the purposes of these Articles be a Member of the Company. 17. Deposit call to be a debt payable Immediately The Money (if any) which the Board shall on the application for allotment of any shares being made by them require or direct to be paid by way of deposit call or otherwise in respect of any shares allotted by them shall immediately on the insertion of the name of the allottee in the Register of Members as the name of the holder of such shares become a debt due to and recoverable by the Company from the allottee thereof and shall be paid by him accordingly. 18. Liability of Members Every Member or his heirs executors or administrators shall pay to the Company the portion of the capital and premium if any represented by or payable on his share or shares which may for the time being remain unpaid thereon in such amounts at such time or times and in such manner as the Board shall from time to time in accordance with the Company's regulations require or fix for the payment thereof. 19. Share Certificates A certificate issued under the common seal of the company specifying the shares held by any person shall be prima facie evidence of the title of the person to such shares. (a) Every Member or allottee of shares who is holding such shares in the physical form shall be entitled without payment to receive certificate specifying the name of the person in whose favour it is issued the shares to which it relates and the amount paid-up thereof. Such certificates shall be issued only in pursuance of a resolution passed by the Board and on surrender to the Company of the letter of allotment or the fractional coupon of requisite value save in case of issues against letters of acceptance or of renunciation or in cases of issue of bonus shares. Every such certificate shall be issued under the seal of the Company which shall be affixed in the presence of two Directors and the Secretary or some other person appointed by the Board for the purpose and the

111



230

two directors and the Secretary or other persons as authorized by the Board shall sign the share certificate. Provided if the composition of the Board permits of it at least one of the aforesaid two directors shall be a person other than a Managing or a Whole Time Director. Particulars of every share certificate issued shall be entered in the Register of Members against the name of the person to whom it has been issued indicating the date of issue. For issue of any further duplicate certificate the Board shall be entitled to charge such amount which shall not exceed fifty Rupees per Certificate. (b) A Director may sign a share certificate by affixing his signature thereon by means of any machine equipment or other mechanical means such as engraving in metal or lithography but not by means of a rubber stamp. PROVIDED that the Director shall be personally responsible for the safe custody of such machine equipment or other material used for the purpose.

20. Renewal of Share Certificates (a) No certificate of any share or shares shall be issued either in exchange for those which are sub-divided or consolidated or in replacement of those which are defaced mutilated torn or old decrepit destroyed or where the pages on the reverse for recording transfers have been duly utilized unless the certificate in lieu of which it is issued is surrendered to the Company and for issuing such share certificate the company may charge such fee as the Board thinks fit not exceeding twenty rupees per certificate. (b) When a new share certificate has been issued in pursuance of clause (a) of this Article it shall state on the face of it and against the stub or counterfoil to the effect that it is issued in lieu of share certificate No. and the word duplicate shall be stamped or printed prominently on the face of the share certificate. (c) If a share certificate is lost or destroyed a new certificate in lieu thereof shall be issued only with the prior consent of the Board and on such reasonable terms such as furnishing supporting evidence and indemnity and the payment of out-of-pocket expenses incurred by the Company in investigating evidence produced as the Board thinks fit. (d) When a new share certificate has been issued in pursuance of clause (c) of this Article it shall state on the face of it and against the stub or counterfoil to the effect that it is duplicate issued in lieu of share certificate No. and the word duplicate shall be stamped or printed prominently on the face of the share certificate. (e) Where a new share certificate has been issued in pursuance of clause (a) and or clause (c) of this Article particulars of every such share certificate shall be entered in a Register of Renewed and Duplicate Share Certificates indicating against the name(s) of the person(s) to whom the certificate is issued the number and date of issue of the share certificate in lieu of which the new certificate is issued and the necessary changes indicated in the Register of Members by suitable cross reference in the Remarks column. (f) All blank forms to be used for issue of share certificates shall be printed and the printing shall be done only on the authority of a resolution of the Board and the blank forms shall be consecutively machine-numbered and the forms and the blocks engravings facsimiles relating to the printing of such forms shall be kept in the custody of the Secretary or of such other person as the Board may appoint for the purpose and the Secretary or the other person aforesaid shall be responsible for rendering an account of these forms to the Board. (g) The Committee of the Board Company Secretary of the Company or a Director specifically authorized by the Board for such purposes shall be responsible for the maintenance preservation and safe custody of all books and documents relating to the issue of share certificates including the blank forms of share certificates referred to in clause (f). (h) All books referred to in clause

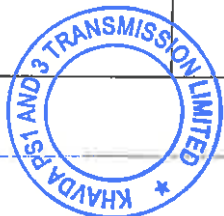

231

(g) shall be preserved in good order for not less than thirty years and in disputed cases shall be preserved permanently. 21. Joint holders (a) Where two or more persons are registered as the holders of any share they shall be treated as a single shareholder and shall be deemed to hold the same as joint holders with benefits of survivorship subject to the following and other provisions contained in these Articles. (b) The Company shall be entitled to decline to register more than four persons as the holders of any share. (c) The Joint holders of any share shall be liable severally as well as jointly for and in respect of all calls and other payments which ought to be made in respect of such shares. (d) On the death of any such joint holder the survivor or survivors shall be the only person or persons recognized by the Company as having any title to the share but the Directors may require such evidence of death as they may deem fit and nothing herein contained shall be taken to release the estate of the deceased joint holder from any liability on shares held by him jointly with any other person. (e) Delivery of share certificate to any one of such joint holders shall be deemed to be delivery to all of them and any one of such joint holders may give effectual discharge and receipts for any dividends or other moneys payable in respect of such shares and or in respect of any other obligation of the Company towards them. (f) Only the person whose name stands in the Register of Members as the first of the joint holders of any shares shall be entitled to delivery of the certificate relating to such share or to receive notices from the Company and any notice given to such person shall be deemed proper notice to all joint holders. (g) Any one of two or more joint holders may vote at any meeting either personally or by proxy in respect of such share as if he were solely entitled thereto and if more than one of such joint holders be present at any meeting personally or by proxy the holder whose name stands first or higher (as the case may be) on the Register of Members in respect of such shares shall alone be entitled to vote in respect thereof. PROVIDED always that a member present at any meeting personally shall be entitled to vote in preference to a person present by proxy although the name of such person present by proxy stands first on the Register of Members in respect of such shares. 22. Terms and Conditions of Preference Shares Subject to the provisions of section 55 any preference shares may with the sanction of an ordinary resolution be issued on the terms that they are to be redeemed on such terms and in such manner as the company before the issue of the shares may by special resolution determine.

<input type="checkbox"/>	<input checked="" type="checkbox"/>	2	•
<input type="checkbox"/>	<input checked="" type="checkbox"/>	3	•
<input type="checkbox"/>	<input checked="" type="checkbox"/>	4	•
<input type="checkbox"/>	<input checked="" type="checkbox"/>	5	•
<input type="checkbox"/>	<input checked="" type="checkbox"/>	6	•
<input type="checkbox"/>	<input checked="" type="checkbox"/>	7	•

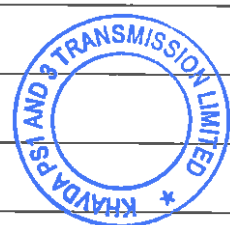

232

<input type="checkbox"/>	<input checked="" type="checkbox"/>	8	•
			<i>Lien</i>
<input type="checkbox"/>	<input checked="" type="checkbox"/>	9	<ul style="list-style-type: none"> • 23. Company to have lien on shares The Company shall have a first and paramount lien upon all shares (other than fully paid up shares) registered in the name of each member (whether solely or jointly with others) and upon the sale proceeds thereof for all moneys (whether presently payable or not) called or payable at a fixed time in respect of all such shares (not being fully paid up) for all moneys presently payable by him or his estate to the Company. Any such lien shall extend to all dividends payable and bonuses declared from time to time declared in respect of such shares. 24. Enforcing lien by sale For the purpose of enforcing such lien the Board may sell the shares subject thereto in such manner as they shall think fit and for that purpose it may cause to be issued a duplicate certificate in respect of such shares and may authorize one of their Directors to execute a transfer thereof on behalf of and in the name of the Board. No sale shall be made until notice period for making call as aforesaid have expired and until notice in writing of the intention to sell shall have been made known to the shareholder for default in payment and default has been made by him in the payment of money called in respect of such shares for thirty days after the date of such notice. Upon issue of a duplicate certificate or certificates in lieu of the original share the certificate or certificates originally issued shall stand cancelled and become null and void and the same shall have no effect. 25. Application of proceeds of sale The net proceeds of any such sale shall be received by the Company and applied in or towards payment of such part of the amount as is presently payable and the residue if any shall (subject to a like lien for sums not presently payable as existed upon the shares before sale) be paid to the person entitled to the shares at the date of the sale.
<input type="checkbox"/>	<input checked="" type="checkbox"/>	10	•
<input type="checkbox"/>	<input checked="" type="checkbox"/>	11	•
<input type="checkbox"/>	<input checked="" type="checkbox"/>	12	•
			<i>Calls on shares</i>
<input type="checkbox"/>	<input checked="" type="checkbox"/>		<ul style="list-style-type: none"> • 26. Directors may make calls The Board may from time to time subject to the terms on which any shares may have been issued and subject to the conditions of allotment by a resolution passed at a meeting of the Board (and not by resolution by circulation) make such call as it thinks fit upon the Members in respect of all moneys unpaid on the shares held by them respectively and each member shall pay the amount of every call so made on him to the person or persons and at the times and places appointed by the board. A call may be made payable by installments. 27. Notice of calls Not less than thirty days notice in writing of any call shall be given by the Company specifying the time and place of payment and the person or persons to whom such call shall be paid. 28. When call made A call shall be deemed to have been made at the time when the resolution of the Board authorizing such call was passed at a meeting of the Board and demand notice is issued. 29. Calls may be

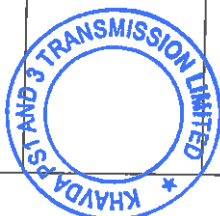

revoked or postponed. A call may be revoked or postponed at the discretion of the Board. 30. Directors may extend time. The Board may from time to time at its discretion extend the time fixed for the payment of any call and may extend such time as to all or any of the Members for reasons which the Board may consider satisfactory but no Member shall be entitled to such extension save as a matter of grace. 31. Calls to carry interest. If any Member fails to pay any call due from him on the day appointed for payment thereof or any such extension thereof as aforesaid he shall be liable to pay interest on the same from the day appointed for the payment thereof to the time of actual payment at rate not exceeding 10 per cent per annum as maybe decided by the Board but the Board may in its absolute discretion and in special circumstances waive or reduce the levy of interest as deemed appropriate. 32. Sums deemed to be call. Any sum which by the terms of issue of a share becomes payable on allotment or at any fixed date whether on account of the nominal value of the share or by way of premium shall for the purposes of these Articles be deemed to be a call duly made and payable on the date on which by the terms of issue the same becomes payable and in case of non-payment all the relevant provisions of these Articles as to payment of interest and expenses for forfeiture or otherwise shall apply as if such sum had become payable by virtue of a call duly made and notified. 33. Partial payment not to preclude Forfeiture. Neither the receipt by the Company of a portion of any money which shall from time to time be due from any Member to the Company in respect of his shares either by way of principal or interest nor any indulgence granted by the Company in respect of the payment of any such money shall preclude the Company from thereafter proceeding to enforce a forfeiture of such shares as hereinafter provided. 34. Payment in anticipation of calls may carry interest. The Board may if it thinks fit agree to and in anticipation receive from any Member willing to advance the same all of calls money or any part of the amounts of his respective shares beyond the sums actually called up and upon the moneys so paid in advance or upon so much thereof from time to time and at any time thereafter as exceeds the amount of the calls then made upon and due in respect of the shares on account of which such advances are made the Board may pay or allow interest at such rate as the Member paying the sum in advance and the Board agree upon. The Board may agree to repay at any time any amount so advanced or may at any time repay the same upon giving to the Member three months notice in writing. PROVIDED that moneys paid in advance of calls on any shares may carry interest but shall not confer a right to dividend or to participate in profits. (b) No Member paying any such sum in advance shall be entitled to voting rights in respect of the moneys so paid by him until the same would but for such payment become presently payable.

13

<input type="checkbox"/>	<input checked="" type="checkbox"/>	14	•
<input type="checkbox"/>	<input checked="" type="checkbox"/>	15	•
<input type="checkbox"/>	<input checked="" type="checkbox"/>	16	•
<input type="checkbox"/>	<input checked="" type="checkbox"/>	17	•

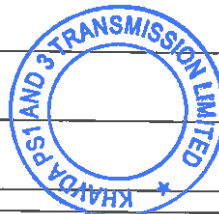

234

<input type="checkbox"/>	<input checked="" type="checkbox"/>	18	•
			<i>Transfer of shares</i>
<input type="checkbox"/>	<input checked="" type="checkbox"/>	19	<ul style="list-style-type: none"> 35. Register of TransfersThe Company shall maintain a Register of Transfers andtherein shall be fairly and distinctively enter the particulars of everytransfer or transmission of any share in the physical form.36. Form of transferThe instrument of transfer shall be in writing and in suchform as prescribed under the Act. All the provisions of Section 56 of the Actshall be duly complied with in respect of all transfers and of the registrationthereof. The Company shall not charge any fee for registration of a transfer ofshares or debentures.37. Instrument of Transfer to be completed and presented tothe CompanyThe Instrument of Transfer duly stamped and executed by thetransferor and the transferee shall be delivered to the Company in accordancewith the provisions of the Act. The instrument of transfer shall be accompaniedby the Share Certificate or such evidences the Board may require to prove thetitle of transferor and his right to transfer the shares and every registeredInstrument of Transfer shall remain in the custody of the Company untildestroyed by order of the Board. Any instrument of transfer which the Directorsmay decline to register shall be returned to the person depositing the same.38. Transferor deemed to be holderThe transferor shall be deemed to be the holder of suchshares until the name of the transferee shall have entered in the Register ofMembers in respect thereof. Before the registration of a transfer thecertificate or certificates of the shares must be delivered to the Companyalong with Transfer Deed.39. No transfer to insolvent etc.No transfer shall be made to a person of unsound mind or toan insolvent.40. Closure of Register of MembersDebenture holdersThe Directors shall have power on giving not less thanseven days previous notice as required by Section 91 of the Act to close theRegister of Transfer Register of Members or Register of Debenture holders orthe register of other security holders of the Company for any period or periodsnot exceeding in the aggregate forty-five days in each year (but not exceedingthirty days at any one time) as they may determine.41. Nomination by shareholderEvery share-holder or debenture holder may at any timenominate in the prescribed manner a person to whom his shares or debentureshall vest in the event of his death as provided in Section 72 of the Act.42. Title to shares of deceased holderIn the event there is no nomination the executors oradministrators of a deceased Member or the holder of a Succession Certificatein respect of the shares of a deceased Member (not being one of two or morejoint holders) shall be the only persons whom the Company will be bound torecognize as having any title to the shares registered in the name of suchMember and the Company shall not be bound to recognize such executors oradministrators or holders unless such executors administrators or holders shallhave first obtained probate or Letters of Administration or SuccessionCertificate as the case may be from a duly constituted Court in India. PROVIDED that the Directors may at their absolutediscretion dispense with production of Probate Letters of Administration orSuccession Certificate upon such terms as to indemnity or otherwise as theythink fit and may enter the name of the person who claims to be absolutelyentitled to the shares standing in the name of a deceased Member as a Member.

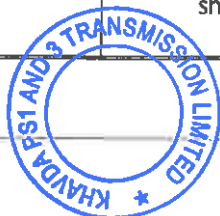

235

<input type="checkbox"/>	<input checked="" type="checkbox"/>	20	o
<input type="checkbox"/>	<input checked="" type="checkbox"/>	21	o
<input type="checkbox"/>	<input checked="" type="checkbox"/>	22	o

Transmission of shares

<input type="checkbox"/>	<input checked="" type="checkbox"/>	23	<ul style="list-style-type: none"> 43. Transmission of Shares Subject to the provisions of the Act any person becoming entitled to any share in consequence of the death lunacy or insolvency of any Member or by any lawful means other than by a transfer in accordance with these Articles may with the consent of the Directors (which they shall be under no obligation to give) and upon producing such evidence that he sustains the character in respect of which he proposes to act under this Article or of his title as the Directors may require and upon such indemnity as the Directors may require either be registered as a Member in respect of such shares or elect to have some person nominated by him and approved by the Directors registered as a Member in respect of such shares. PROVIDED that if such persons shall elect to have his nominee registered he shall testify his election by executing in favor of his nominee an instrument of transfer in accordance with these Articles and until he does so he shall not be freed from any liability in respect of such shares. 44 Right of Board to decline or suspend registration (i) Any person becoming entitled to a share in consequence of the death or insolvency of a member may upon such evidence being produced as may from time to time properly be required by the Board and subject as hereinafter provided elect either --(a) to be registered himself as holder of the share or (b) to make such transfer of the share as the deceased or insolvent member could have made. (ii) The Board shall in either case have the same right to decline or suspend registration as it would have had if the deceased or insolvent member had transferred the share before his death or insolvency. 45. The Company not liable for disregard of notice prohibiting registration of transfer The Company shall incur no liability or responsibility whatever in consequence of its registering or giving effect to any transfer of shares made or purported to be made by any apparent legal owner thereof (as shown or appearing in register of Members) to the prejudice of persons having or claiming any equitable right title or interest to or in the same shares notwithstanding that the Company may have had notice of such equitable right title or interest or notice prohibiting registration of such transfer and may have entered such notice or referred to it in any book or attended or given effect to any notice which may have been given to it of any equitable right title or interest or be under any liability whatsoever for refusing or neglecting so to do though it may have been entered or referred to in some book of the Company but the Company shall nevertheless be at liberty to regard and attend to any such notice and give effect thereto if the Directors shall so think fit. 46. Rights of successors A person becoming entitled to a share by reason of the death or insolvency of the holder shall be entitled to the same dividends and other advantages to which he would have been entitled if he were the registered holder of the shares except that he shall not before being registered as a Member in respect of the shares be entitled to exercise any right conferred by membership in
--------------------------	-------------------------------------	----	---

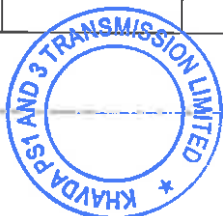

238

relation to meetings of the Company. PROVIDED that the Directors shall at any time give notice requiring any such person to elect to be registered himself or to transfer the shares and if the notice is not complied within ninety days from the date of issue of the notice the Directors may thereafter withhold payment of all dividends bonuses or other moneys payable in respect of the shares until the requirements of the notice have been complied with.

<input type="checkbox"/>	<input checked="" type="checkbox"/>	24
<input type="checkbox"/>	<input checked="" type="checkbox"/>	25
<input type="checkbox"/>	<input checked="" type="checkbox"/>	26
<input type="checkbox"/>	<input checked="" type="checkbox"/>	27

Forfeiture of shares

- 47. If money payable on shares not paid notice to be given to members if any Member fails to pay any call or installment of a call on or before the day appointed for the payment of the same or any such extension thereof as aforesaid the Board may at any time thereafter during such time as any part of the call or installment remains unpaid serve a notice on him requiring him to pay the same together with any interest which may have accrued and all expenses that may have been incurred by the Company by reason of such non-payment. 48. Contents of Notice The notice shall name a further day (not being less than fourteen days from the date of the service of notice) and a place or places and at which such call or installment and such interest thereon at such rate as the Directors shall determine from the day on which such call or installment ought to have been paid and expenses as aforesaid are to be paid. The notice shall also state that in the event of the non-payment on or before the day at or before the time and at the place appointed the shares in respect of which the call was made or installment is payable shall be liable to be forfeited. 49. In default of payment shares to be Forfeited If the requirement of any such notice as aforesaid are not complied with every or any share in respect of which such notice has been given may at any time thereafter but before payment of all calls or installments interest and expenses due in respect thereof be forfeited by a resolution of the Board to that effect. Such forfeiture shall include all dividends declared or any other moneys payable in respect of the aforesaid share and not actually paid before the forfeiture. In default of payment shares to be Forfeited 50. Notice of forfeiture to a Member When any share shall have been so forfeited notice of the forfeiture shall be given to the Member in whose name it stood immediately prior to the forfeiture and an entry of the forfeiture with the date thereof shall forthwith be made in the Register of Members but no forfeiture shall in any manner be invalid by any omission or neglect to make any such entry as aforesaid in the Register. 51. Forfeited share to be property of the Company and may be sold etc. Any share so forfeited shall be deemed to be the property of the Company and may be sold or allotted or otherwise disposed of either to the original holder thereof or to any person upon such terms and in such manner as the Board shall think fit. 52. Member still liable to pay calls owing at the time of forfeiture and



237

	28	<p>interestAny members whose shares have been forfeited shall notwithstanding the forfeiture be liable to pay and shall forthwith pay to the Company on demand all calls installment interest and expenses owing upon or in respect of such shares at the time of the forfeiture together with interest accrued thereon at the time of the forfeiture at such rate as the Board may determine and the Board may enforce the payment thereof if it thinks fit.53. Effect of forfeitureThe forfeiture of a share shall involve extinction at the time of the forfeiture of all interest in and all claims and demands against the Company in respect of the share and all other rights incidental to the share except only such of those rights as by these Articles are expressly saved.54. Evidence of forfeitureA declaration in writing by Chairman or Managing Director of the Company or by any person duly authorised in this regard that certain shares in the Company have been duly forfeited on a date stated in the declaration shall be conclusive evidence of the facts therein stated as against all persons claiming to be entitled to the shares and such declaration and the receipt of the Company for the consideration if any given for the shares on the sale or disposition thereof shall constitute a good title to such shares and the person to whom the shares are sold shall be registered as the holder of such shares and shall not be bound to see as to the application of the purchase money nor shall his title to such shares be affected by any irregularity or invalidity in the proceedings in reference to such forfeiture sale or disposition.55. Validity of sale under Articles of forfeited sharesUpon any sale after forfeiture or for enforcing a lien in purported exercise of the powers herein before given the board may appoint some person to execute an instrument of transfer of the shares sold and cause the purchaser's name to be entered in the Register of Members in respect of the shares sold and the purchaser shall not be bound to see the regularity of the proceedings or to the application of the purchase money and after his name has been entered in the Register in respect of such shares the validity of the sale shall not be impeached by any person and the remedy of any person aggrieved by the sale shall be in damages only and against the Company exclusively.56. Cancellation of Share Certificates in respect of forfeited sharesUpon any sale re-allotment or other disposal under the provisions of the preceding Articles the certificate or certificates originally issued in respect of the relative shares shall (unless the same shall on demand by the Company have been (previously) surrendered to it by the defaulting member) stand cancelled and become null and void and of no effect and the Directors shall be entitled to issue a duplicate certificate or certificates in respect of the said shares to the person or persons entitled thereto.57. Power to annul forfeiture The Board may at any time before any share so forfeited shall have been sold re-allotted or otherwise disposed of annul the forfeiture thereof upon such terms and conditions as it thinks fit.</p>	
<input type="checkbox"/>	<input checked="" type="checkbox"/>	29	•
<input type="checkbox"/>	<input checked="" type="checkbox"/>	30	•
<input type="checkbox"/>	<input checked="" type="checkbox"/>	31	•
<input type="checkbox"/>	<input checked="" type="checkbox"/>	32	•

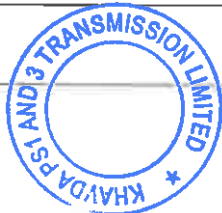

238

<input type="checkbox"/>	<input checked="" type="checkbox"/>	33	•
<input type="checkbox"/>	<input checked="" type="checkbox"/>	34	•
			Alteration of capital
<input type="checkbox"/>	<input checked="" type="checkbox"/>	35	<ul style="list-style-type: none"> 58. Alteration of Share Capital The company may from time to time by ordinary resolution increase the share capital by such sum to be divided into shares of such amount as may be specified in the resolution. Subject to the provisions of section 61 the company may by ordinary resolution the Company may from time to time--(a) consolidate and divide all or any of its share capital into shares of larger amount than its existing shares (b) convert all or any of its fully paid-up shares into stock and reconvert that stock into fully paid-up shares of any denomination (c) Sub-divide its shares or any of them into shares of smaller amount than is fixed by the memorandum so however that in the sub-division the proportion between the amount paid and the amount if any unpaid on each reduced share shall be the same as it was in the case of the share from which the reduced share is derived. (d) Cancel any shares which as the date of the passing of the resolution have not been taken or agreed to be taken by any person and diminish the amount of its share capital by the amount of the shares so cancelled. The resolution whereby any share is sub-divided may determine that as between the holders of the shares resulting from such sub-division one or more of such shares shall have some preference or special advantage as regards dividend capital voting or otherwise over or as compared with the others or other subject to the provisions of the Act. Subject to the provisions of Sections 66 of the Act the Board may accept from any member the surrender on such terms and conditions as shall be agreed of all or any of his shares. The company may by special resolution reduce in any manner and with and subject to any incident authorised and consent required by law--(a) its share capital (b) any capital redemption reserve account or (c) any share premium account.
<input type="checkbox"/>	<input checked="" type="checkbox"/>	36	•
<input type="checkbox"/>	<input checked="" type="checkbox"/>	37	•
<input type="checkbox"/>	<input checked="" type="checkbox"/>	38	•
			Capitalisation of profits
<input type="checkbox"/>	<input checked="" type="checkbox"/>		<ul style="list-style-type: none"> 59. Capitalization of Profits (1) Any General Meeting of the Company may resolve that any amounts standing to the credit of the Free Reserve or Share Premium Account or the Capital Redemption Reserve Account or any moneys investment or other assets forming part of the undivided profits including profits or surplus moneys arising from the realization and (when permitted by the law) from the appreciation in value of any capital assets of the Company standing to the credit of the General Reserve or any other Reserve or Reserve Fund or any other Fund of the Company or in the hands of the Company and available for dividend be capitalized--(a) by the issue and distribution of shares as fully paid-up and to the extent permitted by the Act debentures debenture stock bonds or other

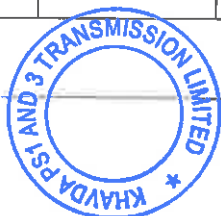

obligations of the Company or (b) by crediting share of the Company which may have been issued and are not fully paid-up with the whole or any part of the sum remaining unpaid thereon PROVIDED that any amounts standing to the credit of the Share Premium Account or the Capital Redemption Reserve Account shall be applied only in crediting the payment of capital on shares to be issued to Members as fully paid bonus shares (Further capitalization of reserve created by the revaluation of assets are not to be used for issuance of Bonus Shares as per section 63 of the Act).

(2) Such issue and distribution under sub-clause (1) (a) of this Article and payment to the credit of unpaid share capital under sub-clause (1) (b) of this Article shall be made among and in favour of the Members or any class of them or any of them entitled thereto and in accordance with their respective rights and interests and in proportion to the amount of capital paid-up on the shares held by them respectively in respect of which such distribution or payment shall be made on the footing that such Members become entitled thereto as capital.

(3) The Directors shall give effect to any such resolution and for the said purpose the Board may settle any difficulty which may arise in regard to distribution as it thinks expedient including in regard to fractional entitlements and shall apply such profits General Reserve other Reserve or any other Fund or account as aforesaid as may be required for the purpose of making payment in full on the shares or other obligations of the Company so distributed under sub-clause (1) (a) of this Article or (as the case may be) for the purpose of paying in whole or in part the amount remaining unpaid on the shares which may have been issued and are not fully paid-up under sub-clause (1) (b) above. PROVIDED that no such distribution or payment shall be made unless recommended by the Directors and if so recommended such distribution and payment shall be accepted by such Members as aforesaid in full satisfaction of their interest in the said capitalized fund.

(4) For the purpose of giving effect to any such resolution the Directors may settle any difficulty which may arise in regard to the distribution or payment as aforesaid as they think expedient and in particular they may issue fractional certificates and may fix the value for distribution of any specific asset and may determine that any cash payment be made to any Members on the footing of the value so fixed and may vest any such cash shares debentures stock bonds or other obligations in trustees upon such trusts for the persons entitled thereto as may seem expedient to the directors and generally may make arrangement for the acceptance allotment and sale of such shares debentures debentures stock bonds or other obligations and fractional certificates or otherwise as they may think fit.

(5) When deemed requisite a proper contract shall be filed in accordance with the Act and the Board may appoint any person to sign such contract on behalf of the Members entitled as aforesaid. Subject to the provisions of the Act and these Articles in cases where some of the shares of the Company are fully paid and others are partly paid such capitalization may be effected by the distribution of further shares in respect of the fully paid shares and by crediting the partly paid shares with the whole or part of the unpaid liability thereon but so that as between the holders of the fully paid shares and the partly paid shares the sums so applied in the payment of such further shares and in the extinguishment or diminution of the liability on the partly paid shares shall be applied pro rata in proportion to the amount then already paid or credited as paid on the existing fully

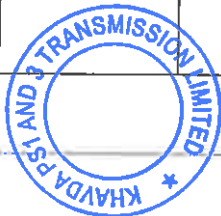

			paid and partly paid shares respectively.
<input type="checkbox"/>	<input checked="" type="checkbox"/>	40	•
			Buy-back of shares
<input type="checkbox"/>	<input checked="" type="checkbox"/>	41	<ul style="list-style-type: none"> 60. Buy Back of Shares Notwithstanding anything contained in these articles but subject to the provisions of sections 68 to 70 and any other applicable provision of the Act or any other law for the time being in force the company may purchase its own shares or other specified securities.
			General meetings
<input type="checkbox"/>	<input checked="" type="checkbox"/>	42	<ul style="list-style-type: none"> 61. Annual General Meeting The Company shall in each year hold a General Meeting as its Annual General Meeting in addition to any other meeting in that year. All General Meetings other than Annual General Meetings shall be called Extraordinary General Meetings. If for any reason beyond the control of the Board the general meeting (including an Annual General meeting) cannot be held on the appointed day the Board shall have power to postpone the General meeting of which a notice should be given to the members. Every member of the Company shall be entitled to attend either in person or by proxy and the Auditor of the Company shall have the right to attend and to be heard at any General Meeting which he attends on any part of the business which concerns him as Auditor. 62. Extraordinary General Meeting The Board may whenever it thinks fit call an Extraordinary General Meeting of the Company. The Board shall at the requisition in writing by a Member or Members holding in the aggregate not less than one-tenth of such of the paid-up capital of the company on that date and carries the right of voting in regard to the matter in respect of which the requisition has been made. 63. Requisition of Members to state object of Meeting Any valid requisition so made by Members must state the object or objects of the meeting proposed to be called and must be signed by the requisitionists and deposited at the registered office of the company. PROVIDED that such requisition may consist of several documents in like form each signed by one or more requisitionists. 65. On receipt of requisition Directors to call meeting and in default requisitionists may do so Upon the receipt of any such requisition the Board shall forthwith call an Extraordinary General Meeting and if they do not proceed within twenty-one days from the date of the requisition being deposited at the Registered Office to cause a meeting to be called on a day not later than forty-five days from the date of deposit of the requisition the requisitionists or such of their number as represent either a majority in value of the paid-up share capital held by all of them or one-tenth of such of the paid-up share capital of the Company as is referred to in Section 100(2) of the Act whichever is less may themselves call the meeting but in either case any meeting so called shall be held within three months from the date of the deposit of the requisition as aforesaid. 66. Meeting called by requisitionists Any meeting called under the foregoing Articles by requisitionists shall be called in the same manner as nearly as possible as that in which meetings are to be called by the Board. 67. Twenty-one days notice of meeting to be given A general meeting of a Company may be called by giving not less than clear twenty-one days notice either

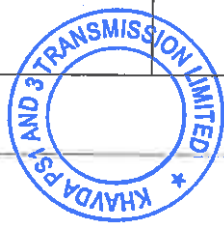

241

In writing or through electronic mode in such a manner as may be prescribed Every notice of a meeting shall specify the place date day and the hour of meeting and shall contain statement of the business to be transacted at such meeting. And The notice of every meeting shall be given to every member of the Company
 Legal Representative of any deceased member or the assignee of an insolvent member auditor or auditors of the Company and every director of the Company and all such persons as are under these Articles entitled to receive notice from the Company Provided that a general meeting may be called after giving shorter notice than that specified in this sub-section if consent in writing or by electronic mode is accorded thereto (i) in the case of an annual general meeting by not less than ninety-five per cent. of the members entitled to vote thereat and (ii) in the case of any other general meeting by members of the company (a) holding if the company has a share capital majority in number of members entitled to vote and who represent not less than ninety-five per cent. of such part of the paid-up share capital of the company as gives a right to vote at the meeting or (b) having if the company has no share capital not less than ninety-five per cent. of the total voting power exercisable at that meeting Provided further that where any member of a company is entitled to vote only on some resolution or resolutions to be moved at a meeting and not on the others those members shall be taken into account for the purposes of this sub-section in respect of the former resolution or resolutions and not in respect of the latter..

43

•

Proceedings at general meetings

• 68. Business to be transacted at the General Meeting and nature thereof In the case of an Annual General Meeting all business to be transacted thereat shall be deemed special other than (i) the consideration of the financial statements and the reports of the Board of Directors and Auditors (ii) the declaration of any dividend (iii) the appointment of Directors in place of those retiring (iv) the appointment of and the fixing of the remuneration of the Auditors and in the case of any other meeting all business shall be deemed to be Special Business and there shall be annexed to the notice of the Meeting an Explanatory statement setting out all material facts concerning each such item of special business including in particular the nature of the concern or interest financial or otherwise if any therein of (i) every Director and the Manager (if any) (ii) every other key managerial personnel and relatives of the persons mentioned in sub clauses (i) and (ii). Where any such item of Special Business relates to or affects any other company the extent of shareholding interest in such other company of every promoter director and the manager if any and of every other key managerial personnel of the Company shall also be set out in the statement if the extent of such shareholding interest is not less than two per cent of the paid-up share capital of that other company and where any item of business consists of the according of approval to any documents by the meeting the time and place where the document can be inspected shall be specified in the statement aforesaid. The annual general meeting shall be called during business hours on any day that is not a National Holiday and it is to be held either at the registered office of the company or at

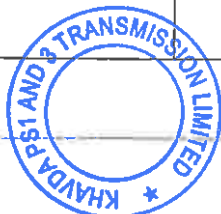

242

some other place within the city in which the registered office of the company is situate. 69. Omission to give notice not to invalidate a resolution passed The accidental omission to give any such notice as aforesaid to any of the Members or the non-receipt thereof shall not invalidate any resolution passed at any such meeting. 70. Meeting not to transact business not mentioned in notice No General Meeting Annual or Extraordinary shall be competent to enter upon discuss or transact any business which has not been mentioned in the notice or notices upon which it was convened. 71. Body Corporate deemed to be personally present A body corporate being a Member shall be deemed to be personally present if it is represented in accordance with Section: 113 of the Act. 72. Quorum at General Meeting No business shall be transacted at any general meeting unless a quorum of members is present at the time when the meeting proceeds to business. Save as otherwise provided herein the quorum for the general meetings shall be as provided in section 103 of the Companies Act 2013. 73. If quorum not present meeting to be dissolved or adjourned If at the expiration of half an hour from the time appointed for holding a general meeting of the Company a quorum is not present the meeting if convened by or upon the requisition of Members shall stand dissolved but in any other case the meeting shall stand adjourned to the same day in the next week or if that day is a public holiday until the next succeeding day which is not a public holiday at the same time and place or to such other day and at such other time place as the Board may determine and if at such adjourned meeting a quorum is not present at the expiration of half an hour from the time appointed for holding the meeting the Members present shall form the quorum and may transact the business for which the meeting was called. 74. Chairman of General Meeting The Chairman of the Board shall be entitled to take the Chair at every General Meeting whether Annual or Extraordinary. If at any meeting the Chairman is not present within fifteen minutes of the time appointed for holding such meeting or he has informed that he shall be unable or unwilling to take the Chair then any one of directors with mutual consent shall so preside at the meeting. If no Director be present or if all the Directors present decline to take the Chair then the Members present shall elect one of the members to be the Chairman of the Meeting. 75. No Business whilst chair vacant No business shall be discussed at any General Meeting except the election of a Chairman whilst the Chair is vacant. 76. Chairman with consent may adjourn meeting The Chairman with the consent of the Members may adjourn any meeting from time to time and from place to place within the city town or village in which the Registered Office of the Company is situated but no business shall be transacted at any adjourned meeting other than the business left unfinished at the meeting from which the adjournment took place. Notwithstanding the provision as above in the event of disorder at a validly convened meeting the Chairman may adjourn the meeting provided that such an adjournment shall not be a longer period than the Chairman considers necessary to being order at the meeting and Chairman communicates his decision to those present in so far as it is possible. 77. Questions at General Meeting how Decided Every question submitted to a meeting shall be decided in the first instance unless a poll is demanded on a show of hands. Before or on the declaration of the result of the voting on any resolution on a show of hands a poll may be ordered to be taken by the Chairman of the meeting on his own motion and shall be ordered to be taken

44

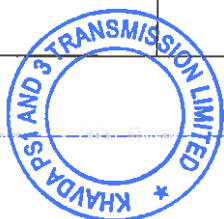

243

by him on a demand made in that behalf by any member or members present in person or by proxy and holding shares in the Company which confer a power to vote on the resolution not being less than one-tenth of the total voting power in respect of the Resolution on which an aggregate sum of not less than five lakh rupees has been paid up. The demand for a poll may be withdrawn at any time by the person or persons making the demand. Unless a poll is so demanded a declaration by the Chairman that a resolution has on show of hands been carried through unanimously or by a particular majority or lost and an entry to that effect in the Minutes Book of the Company shall be conclusive evidence of the fact without proof of the number or proportion of the votes recorded in favour of or against the resolution. 78. Chairmans Casting Vote In the case of an equality of votes the Chairman shall have a casting vote in addition to the vote or votes to which he may be entitled otherwise. 79. Poll to be taken if demanded If a poll is demanded as aforesaid the same shall be taken at such time (not later than forty-eight hours from the time when the demand was made) and place in the city or town in which the Registered office of the Company is for the time being situated as the Chairman shall direct either at once or after an interval or adjournment and the result of the poll shall be deemed to be the resolution of the meeting. 80. In which case poll taken without Adjournment Any poll duly demanded on the election of the Chairman of a meeting or on any question of adjournment shall be taken at the meeting forthwith. 81. Demand for poll not to prevent transaction of other business The demand for a poll except on the questions of the election of the Chairman and of an adjournment shall not prevent the continuance of a meeting for the transaction of any business other than the question on which the poll has been demanded. 82. Minutes of General Meetings (a) The Company shall cause minutes of the proceedings of every General Meeting or every resolution passed by postal ballot to be kept by making within thirty days of the conclusion of every such meeting concerned record thereof kept with Minute Book for that purpose with their pages consecutively numbered. (b) Each page of every such book shall be initialed or signed and the last page of the record of proceedings of each meeting in such book shall be dated and signed by the Chairman of the same meeting within the aforesaid period of thirty days or in the event of the death or inability of that Chairman within that period by a Director duly authorised by the Board for the purpose. (c) In no case the minutes of proceedings of a meeting shall be attached to any such book as aforesaid by pasting or otherwise. (d) The minutes of each meeting shall contain a fair and correct summary of the proceedings thereat. (e) All decisions taken and appointments of officers made at any meeting aforesaid shall be included in the minutes of the meeting. (f) Nothing herein contained shall require or be deemed to require the inclusion in any such minutes of any matter which in the opinion of the Chairman of the meeting (a) is or could reasonably be regarded as defamatory of any person or (b) is irrelevant or immaterial to the proceedings or (c) is detrimental to the interests of the Company. The Chairman of the meeting shall exercise an absolute discretion in regard to the inclusion or non-inclusion of any matter in the minutes on the aforesaid grounds. (g) Any such minutes shall be evidence of the proceedings recorded therein. Where the minutes have been kept in accordance with section then until the contrary is proved the meeting shall be deemed to have been duly called and held all appointments of directors key managerial personnel auditors or

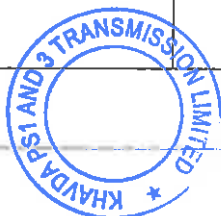

244

company secretary in practice shall be deemed to be valid. No document purporting to be a report of the proceedings of any general meeting of a company shall be circulated or advertised at the expense of the company unless it includes the matters required to be contained in the minutes of the proceedings of such meeting. The company shall observe secretarial standards with respect to general and Board meetings specified by the Institute of Company Secretaries of India constituted under section 3 of the Company Secretaries Act 1980 and approved as such by the Central Government. (h) The book containing the minutes of the proceedings of any general meeting of the Company or of a resolution passed by postal ballot shall be kept at the registered office of the Company and shall be open during business hours to the inspection by any member without any charge for such period not being less than two hours in each business day are allowed for inspection.

<input type="checkbox"/>	<input checked="" type="checkbox"/>	45	•
<input type="checkbox"/>	<input checked="" type="checkbox"/>	46	•
<input type="checkbox"/>	<input checked="" type="checkbox"/>	47	•
<input type="checkbox"/>	<input checked="" type="checkbox"/>	48	•

Adjournment of meeting

<input type="checkbox"/>	<input checked="" type="checkbox"/>	49	<ul style="list-style-type: none"> 83. Adjournment of Meeting (i) The Chairperson may with the consent of any meeting at which a quorum is present and shall if so directed by the meeting adjourn the meeting from time to time and from place to place. (ii) No business shall be transacted at any adjourned meeting other than the business left unfinished at the meeting from which the adjournment took place. (iii) When a meeting is adjourned for thirty days or more notice of the adjourned meeting shall be given as in the case of an original meeting. (iv) Save as aforesaid and as provided in section 103 of the Act it shall not be necessary to give any notice of an adjournment or of the business to be transacted at an adjourned meeting.
<input type="checkbox"/>	<input checked="" type="checkbox"/>		

Voting rights

<input type="checkbox"/>	<input checked="" type="checkbox"/>		<ul style="list-style-type: none"> 84. Members in arrears not to vote No member shall be entitled to vote either personally or by proxy at any General Meeting or Meeting of a class of shareholders either upon a show of hands or upon a poll in respect of any shares registered in his name on which any calls or other sums presently payable by him have not been paid or in regard to which the Company has exercised any right of lien. 85. Number of votes to which Member Entitled Subject to the provisions of these Articles and without prejudice to any special privileges or restrictions as to voting for the time being attached to any class of shares for the time being forming part of the capital of the Company every Member shall be entitled to be present and to speak and vote at such meeting by show of hand for which the Member present in person shall have one vote. On a poll taken at a meeting of a company a member entitled to more than one vote or his proxy need not to use all his votes or cast in the same way all the
<input type="checkbox"/>	<input checked="" type="checkbox"/>		

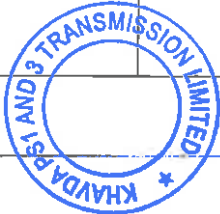

245

votes he uses.86. Votes by a Member entitled to more than one voteOn a poll taken at a meeting of the Company a Member entitled to more than one vote by virtue of his share-holding or his proxy or other person entitled to vote for him as the case may be need not if he votes use all his votes or cast in the same way all the votes he uses and he may vote in different manner as he deems fit.87. Vote of Member who is a minor if any shareholder be a minor the vote in respect of his share or shares shall be by his guardian or any one of his guardians if more than one to be selected in case of dispute by the Chairman of the meeting.88. Votes of Joint Members if there be joint registered holders of any shares the vote of the senior who tenders a vote whether in person or by proxy shall be accepted to the exclusion of the votes of the other joint holders. For this purpose seniority shall be determined by the order in which the names stand in the register of members.89. Voting in person or by proxy or Representative Subject to the provisions of these Articles votes may be given either personally or by proxy. A body corporate being a Member may vote either by proxy or by a representative duly authorised in accordance with Section 113 of the Act and such representative shall be entitled to exercise the same rights and powers (including the right to vote by proxy) and by postal ballot on behalf of the body corporate which he represents as that body could exercise if it were an individual Member of the Company.90. Votes in respect of shares of Deceased Any person entitled under the Transmission Clause to transfer any shares may vote at any General Meeting in respect thereof in the same manner as if he were the registered holder of such shares. PROVIDED that forty-eight hours at least before the time of holding the meeting or adjourned meeting as the case may be at which he proposes to vote he shall satisfy the Chairman of his right to transfer such shares and give such indemnity (if any) as the Chairman may require or the Chairman shall have previously admitted his right to vote at such meeting in respect thereof.91. Time for objection to vote No objection shall be made to the validity of any vote except at the meeting or poll at which such vote was tendered and every vote whether given personally or by proxy not disallowed at such meeting or poll shall be deemed valid for purposes of such meeting or poll whatsoever.92. Chairman of the meeting to be the judge of the validity of any Vote The Chairman of any meeting shall be the sole judge of the validity of every vote tendered at such meeting. The Chairman present at the taking of a poll shall be the sole judge of the validity of every vote tendered at such poll.

50

<input type="checkbox"/>	<input checked="" type="checkbox"/>	51	•
<input type="checkbox"/>	<input checked="" type="checkbox"/>	52	•
<input type="checkbox"/>	<input checked="" type="checkbox"/>	53	•
<input type="checkbox"/>	<input checked="" type="checkbox"/>	54	•
<input type="checkbox"/>	<input checked="" type="checkbox"/>	55	•
<input type="checkbox"/>	<input checked="" type="checkbox"/>	56	•

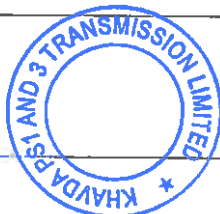

246

			Proxy
<input type="checkbox"/>	<input checked="" type="checkbox"/>	57	<ul style="list-style-type: none"> 93. Appointment of proxy A person can act as proxy on behalf of members not exceeding fifty and holding in the aggregate not more than ten percent of the total share capital of the company carrying voting rights Provided that a member holding more than ten percent of the total share capital of the Company carrying voting rights may appoint a single person as proxy and such person shall not act as proxy for any other person or shareholder. Every proxy shall be appointed in writing under the hand of the Member or if such Member is a body corporate under the common seal of such corporation or be signed by an appointer or his attorney duly authorised in writing. The proxy so appointed shall not have any right to speak at the meetings. 94. Deposit of instrument of Proxy etc. The instrument appointing a proxy and the power of attorney or other authority (if any) under which it is signed or a notarized copy of that power or authority shall be deposited at the Registered Office of the Company not later than forty-eight hours before the time for holding the meeting at which the person named in the instrument proposes to vote and in default the instrument of proxy shall not be treated as valid. No instrument appointing a proxy shall be valid after the expiration of twelve months from the date of its execution. 95. Form of proxy An instrument appointing a proxy shall be in the form No.MGT-11 as prescribed in the rules made under section 105 of the Companies Act 2013. 96. Proxy either for specified meeting or for a period An instrument of proxy may appoint a proxy either for the purpose of a particular meeting specified in the instrument and any adjournment thereof or it may appoint for the purpose of every meeting of the Company or of every meeting to be held before a date specified in the instrument and every adjournment of any such meeting. 97. Validity of votes given by proxy notwithstanding death of Member A vote given in accordance with the terms of an instrument of proxy shall be valid notwithstanding the previous death or insanity of the principal or the revocation of the proxy or of the authority under which the proxy was executed or the transfer of the shares in respect of which the proxy is given. Provided that no intimation in writing of such death insanity revocation or transfer shall have been received by the company at its office before the commencement of the meeting or adjourned meeting at which the proxy is used.
<input type="checkbox"/>	<input checked="" type="checkbox"/>	58	•
<input type="checkbox"/>	<input checked="" type="checkbox"/>	59	•
			Board of Directors
<input type="checkbox"/>	<input checked="" type="checkbox"/>		<ul style="list-style-type: none"> 98. Management of Affairs The day to day management of the business and affairs of the Company shall be vested with Project-in-charge under the supervision direction control of the Board. The Board may exercise all such powers of the Company and do all such acts deeds and things as are not prohibited by the Act or any other statute or by the Memorandum of Association of the Company and without prejudice to the foregoing shall be responsible for all policy matters and the supervision direction and control of the conduct of the business affairs operations of the Company. 99. First Directors Shri Neeraj Singh Shri Rishab Jain and Shri Naveen

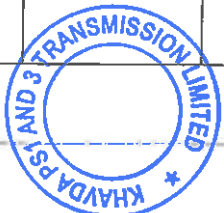

2476

Kumar shall be the First Directors of the Company. 100. Number and appointment of Directors The Board of Directors of the Company shall consist of not less than 3 but not more than 15 Directors. A Director shall not be required to hold any qualification shares in the Company. Notwithstanding anything to the contrary contained in these Articles so long as any moneys remain owing by the Company to a Financial Institution or any other person by the Company or the Company has entered into any agreement or undertaking or arrangement (hereinafter refer as agreement) with Bodies (like State Electricity Board Nigam) or the Board of Directors have decided to seek nomination on the Board from the beneficiary state or any Financial Institution or PFC Consulting Limited or person holds Debentures in the Company by direct subscription or private placement the Company may agree to grant to such Financial Institution PFC Consulting Limited person or other Bodies as a condition of such loan or subscription to Debenture or any other agreement or to a Debenture Trustee the right to appoint from time to time any person or persons as Director or Directors of the Company (which director or directors is are hereinafter referred to as Nominee Directors) retiring or non-retiring subject to and on such terms and conditions as the Company may agree with such Financial Institutions PFC Consulting Limited Person other Bodies and or Debenture Trustee. The Company shall have a right to remove from office Nominee Director(s) at the option of the Company in consultation with Financial Institutions PFC Consulting Limited Bodies persons or Debenture Trustee. Such Nominee Director(s) shall not be required to hold any Share qualification in the Company. Also at the option of the Company such Nominee Director(s) shall not be liable to retirement by rotation of the Directors. Subject as aforesaid the Nominee Director(s) shall be entitled to the same rights and privileges and be subject to the same obligations as any other Director of the Company. The Nominee Director(s) so appointed shall hold the said office only so long as moneys remain owing by the Company to the Financial Institution or so long as the Debenture Trustee hold debenture in the Company or operation of agreement and the Nominee Directors so appointed in the exercise of the said person shall ipso facto vacate such office immediately the money owing by the Company to the Financial Institution or on the Debenture Trustee ceasing to hold Debentures Shares on the satisfaction of liability of the Company arising out of any Guarantee furnished by the Financial Institutions or satisfactory completion of term of agreement with Bodies. The Nominee Director(s) appointed under this article shall be entitled to receive all notice of and attend all General meeting Board Meeting and of the meetings of the Committee of which the Nominee Director(s) is a member(s) as also the minutes of meetings. The financial institutions Debenture Trustee persons bodies shall also be entitled to receive all such notice and minutes. The Company shall pay to the Nominee Director(s) sitting fees and expenses which other Director of the Company are entitled but if any other fees commission remuneration in any form is payable to the Director of the Company the fees commission money and remuneration in relation to such Nominee Director(s) shall accrued to Debenture Trustee and same shall accordingly be paid by the Company directly to the debenture trustee. Any expenses that may incurred by the financial institution or such Nominee Director(s) in connection with their appointment or Directorship shall also be paid or reimbursed by the Company to the financial Institution or as the case may be to such Nominee



248

Director(s). Provided that if any such Nominee Director(s) is are an officer of the Financial Institution the sitting fees in relation to such Nominee Director(s) shall also accrue to the Financial Institute and the same shall accordingly be paid by the Company directly to that Financial Institution. Provided further that if such Nominee Director(s) is are an official of any of the Reserve Bank of India the sitting fees in relation to such Nominee Director(s) shall also accrue to Financial Institution to whom here represents as Nominee Director from Reserve Bank of India and the same shall accordingly be paid by the Company directly to that Financial Institution. Provided also that in the event of the Nominee Director(s) being appointed as Whole Time Director(s) such Nominee Director(s) shall exercise such powers and duties as may be approved by the Lenders or Bodies in consultation with Board and have such rights as are usually exercised or available to a Whole Time Director in management of the Borrower or Bodies and such Nominee Director(s) shall be entitled to receive such remuneration fees commission and moneys as may be approved by the Lenders or Bodies in consultation with Board.

101. Company may increase the number of Directors Subject to Section 149 of the Act the Company may subject to special resolution in General Meeting increase the maximum number of Directors. Further the Company may subject to the provisions of Section 169 of the Act by passing the ordinary resolution in the General Meeting of the members may remove any Director before the expiration of his period of office and appoint another person in the place of director so removed.

102. Appointment of Alternate Directors In accordance with Section 161 and other applicable provisions (if any) of the Act the Board shall have power at any time and from time to time to appoint a person not being a person holding any alternate directorship for any other Director in the Company to act as an alternate director for a director (hereinafter called the original Director) during his absence for a period of not less than three months from India.

103. Directors power to fill up casual Vacancies Casual vacancies among Directors may be filled by the Board of Directors at their meeting and any person so appointed shall hold the office as per the provision of section 161.

104. Appointment of Additional Director Subject to the provisions of Section 161 and other applicable provisions (if any) of the Act the Board shall have power at any time and from time to time to appoint a person as an Additional Director but so that the total number of Directors shall not at any time exceed the maximum number fixed by these Articles. The Additional Director so appointed shall retire from Office at next following Annual General Meeting but shall be eligible for election by the company at that meeting as a Director.

105. Directors may act notwithstanding any vacancy The continuing Directors may act notwithstanding any vacancy in their body but if and so long as their number is reduced below the minimum number fixed by Article 100 thereof the continuing Directors may act for the purpose of increasing the number of Directors to that number or of summoning a General Meeting for that purpose.

106. Remuneration of Directors Subject to the provisions of the Act the Chairman or Managing Director or any other functional Directors who is are in the whole-time employment of the Company may be paid remuneration either by way of a monthly payment or at a specified percentage of the net profit of the Company or partly by one way and partly by the other keeping in view the limiting provisions governing the Managerial remuneration under the provisions of the Act. Subject to the provisions of the Act a Director who is neither in the whole-time

60

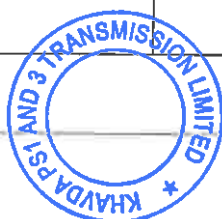

249

employment nor a Chairman cum Managing Director of the Company may be paid remuneration either-(a) by way of monthly quarterly or annual payment with the approval of the Central Government or (b) by way of commission if the Company by a special resolution authorizes such payment and The sitting fee payable to a Director (excluding Whole-time Director) for attending a meeting of the Board or Committee thereof shall be such sum as may be fixed by the Board provided that the same shall not exceed Rs. 100000- or such other sum as prescribed in the Act as amended from time to time. Travelling expenses incurred by Director going out on Company's Business The Board may allow and pay to any Director who is not a bona-fide resident of the place where the Registered Office of the Company or where the meetings of the Board are actually held and who has to come to such place for the purpose of attending any meeting such sum as the Board may consider fair compensation for travelling boarding lodging and other actual incidental expenses in addition to his fee for attending such meeting as specified above. If any Director be called upon to go or reside out of the bona-fide place of his residence on the Company's business he shall be entitled to be paid and reimbursed any travelling or other actual expenses incurred by him in connection with the business of the Company.

107. When office of Directors to become Vacant Subject to Section 167 of the Act the office of a Director shall become vacant if-(a) he incurs any of the disqualifications specified in section 164 under the act (b) he absents himself from all the meetings of the Board of Directors held during a period of twelve months with or without seeking leave of absence of the Board (c) he acts in contravention of the provisions of entering into contracts or arrangements in which he is directly or indirectly interested (d) he fails to disclose his interest in any contract or arrangement in which he is directly or indirectly interested (e) he becomes disqualified by an order of a court or the Tribunal (f) he is convicted by a court of any offence whether involving moral turpitude or otherwise and sentenced in respect thereof to imprisonment for not less than six months Provided that the office shall be vacated by the director even if he has filed an appeal against the order of such court (g) he is removed in pursuance of the provisions of this Act (h) he having been appointed a director by virtue of his holding any office or other employment in the holding subsidiary or associate company ceases to hold such office or other employment in that company.

108. Directors may contract with Company Except with the consent of the Board of Directors given by a resolution at a meeting of the Board and subject to such conditions the company shall not enter into any contract or arrangement with a related party with respect to (a) sale purchase or supply of any goods or materials (b) selling or otherwise disposing of or buying property of any kind (c) leasing of property of any kind (d) availing or rendering of any services (e) appointment of any agent for purchase or sale of goods materials services or property (f) such related party's appointment to any office or place of profit in the company its subsidiary company or associate company (g) underwriting the subscription of any securities or derivatives thereof of the company. Every contract or arrangement entered as related party transaction shall be referred in the Board's report to the shareholders along with the justification for entering into such contract or arrangement.

109. Disclosure of interest by Directors 1) Every Director of the Company who is in any way whether directly or indirectly concerned or interested in a contract or arrangement proposed by Directors interested in a contract or arrangement or

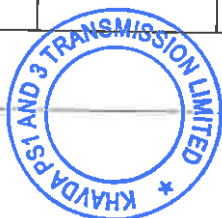

250

proposed contract or arrangement entered into or to be entered into by or on behalf of the Company shall disclose the nature of his concern or interest at every financial year or whenever there is change in the disclosure of interest. (2) Nothing in sub-clause (1) of this Article shall apply to any contract or arrangement entered into or to be entered into between the Company and any other company where any of the Directors of the Company or two or more of the Directors together holds or hold not more than two per cent of the paid-up share capital in the other company. 110. Interested Directors not to participate or vote in Board proceedings An interested director who is in any way whether by himself or through any of his relatives or firm body corporate or other association of individuals in which he or any of his relatives is a partner, director or a member interested in a contract or arrangement or proposed contract or arrangement entered into or to be entered into by or on behalf of a company shall take any part in the discussion of or vote on any contract or arrangement entered into or to be entered into by or on behalf of the Company if he is in any way whether directly or indirectly concerned or interested in such contract or arrangement nor shall his presence count for the purpose of forming a quorum at the time of any such discussion or vote and if he does vote his vote shall be void. A contract or arrangement entered into by the company without disclosure or with participation by a director who is concerned or interested in any way directly or indirectly in the contract or arrangement shall be voidable at the option of the company. 111. Register of Contracts in which Directors are interested The company shall keep registers in accordance with Section 189(1) giving separately the particulars of all contracts or arrangements to which the matter of disclosure of interest by directors and related party transaction applies in such manner and containing such particulars as may be prescribed and after entering the particulars such registers shall be placed before the next meeting of the Board and signed by all the directors present at the meeting and shall within thirty days of appointment make such disclosure as are necessary for the purpose of same. The Register shall be kept at the Registered office of the Company and shall be open to inspection at such office shall be open for inspection at such office during business hours and extracts may be taken therefrom and copies thereof as may be required by any member of the company shall be furnished by the company to such extent in such manner and on payment of same fee as in the case of the Register of Members of the Company. 112. Director may be Director of companies promoted by the Company A Director may become a Director of any other company promoted by the Company or in which it may be interested as a vendor, shareholder or otherwise and no such Director shall be accountable for any benefits received as Director or shareholder of such a company except in so far as Section 188 of the Act may be applicable. 113. Register of Directors and key managerial personnel and their Shareholding The Company shall keep at its registered office a Register containing such particulars of its Directors and key managerial personnel (manager) as may be prescribed under Section 170 of the Act and shall comply with the provisions of the said Section in all respects. The registers shall include the details of securities held by each of them in the company or its holding subsidiary or subsidiary of companies holding company or associate companies.

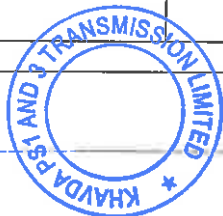

257

<input type="checkbox"/>	<input checked="" type="checkbox"/>	61	•
<input type="checkbox"/>	<input checked="" type="checkbox"/>	62	•
<input type="checkbox"/>	<input checked="" type="checkbox"/>	63	•
<input type="checkbox"/>	<input checked="" type="checkbox"/>	64	•
<input type="checkbox"/>	<input checked="" type="checkbox"/>	65	•
<input type="checkbox"/>	<input checked="" type="checkbox"/>	66	•

Proceedings of the Board

<input type="checkbox"/>	<input checked="" type="checkbox"/>		<ul style="list-style-type: none"> • 114. Meetings of DirectorsThe Directors may meet together as a Board for the dispatchof business from time to time so that at least four such meetings shall beheld in every year in such a manner that not more than one hundred and twentydays shall intervene between two consecutive meetings of the Board. TheDirectors may adjourn and regulate their meetings as they think fit.115. Board may appoint ChairmanAll meetings of the Directors shall be presided over by theChairman if present but if at any meeting of the Directors the Chairman isnot present at the time appointed for holding the same then in that case theDirectors shall choose one of the Directors present to preside over themeeting.116. Certain persons not to beappointed Chairman Managing Directors Functional DirectorTheCompany shall not appoint a person as its Chairman Managing Director or Whole-time Directorwho-(a) is an undischarged insolvent or had at any time beenadjudged an insolvent(b) is or has at any time been convicted by a Court of an offence involving moralurptitude.117. Notice of Directors MeetingA meeting of the Board shall be called by giving not lessthan seven days notice in writing to every director at his address registeredwith the company and such notice shall be sent by hand delivery or by post orb by electronic means. Board may be called at shorter notice to transact urgentbusiness where at least one independent director if any shall be present.Every notice convening a meeting of the Board of Directorsshall set out the agenda of the business to be transacted thereat in sufficientdetail provided however that the meeting may consider any other business withthe permission of the chair.118. When meeting to be convenedThe Company Secretary or any director of the Company may asand when directed by the Chairman to do so convene a meeting of the Board bygiving a notice in writing to every Director.119. Quorum at Board Meeting No business shall be transacted at any Board meeting unlessa quorum of Board of Director is present at the time when the meeting proceedsto business. Save as otherwiseprovided herein the quorum for the Board meetings shall be as provided insection 174.120. Questions at Board meetings how to be decidedAll questions arising at a Meeting of the Board or anycommittee thereof shall be decided by majority of votes of directors presentand in case of equality of votes the Chairperson shall have a second andcasting vote.121. Committee of BoardSubject to the restrictions contained in Section 179 180and other applicable provisions of the Act and preceding Articles the Boardmay delegate any of its powers to Committees of the Board consisting of
--------------------------	-------------------------------------	--	---

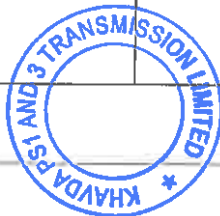

252

such member or members of its body as it may think fit. PROVIDED that the Board may from time to time revoke modify and discharge any such Committee of the Board either wholly or in part. Every Committee of the Board so formed shall in the exercise of the powers so delegated conform to any Policy regulations that may from time to time be laid down by the Board. All acts done by any such Committee of the Board in conformity with such regulations and in fulfillment of the purposes of their appointment shall have the like force and effect as if done by the Board.

122. Meeting of Committee how to be Governed The meetings and proceedings of any such Committee of the Board consisting of two or more members shall be governed by the provisions of the act and guidelines laid down for regulating the meetings and proceedings of the Directors so far as the same are applicable thereto and are not superseded by any regulations made by Directors under the last preceding Article.

123. Resolution by circulation No resolution on matters shall be deemed to have been duly passed by the Board or by a Committee thereof by circulation unless the resolution has been circulated in draft together with the necessary papers if any to all the Directors or members of the Committee as the case may be at their addresses registered with the company in India by hand delivery or by post or by courier or through such electronic means as may be prescribed and has been approved by a majority of the directors or members who are entitled to vote on the resolution. Resolution passed in such circulation shall be made part of the minutes of such meeting. Provided that where not less than one-third of the total number of directors of the company for the time being require that any resolution under circulation must be decided at a meeting the chairperson shall put the resolution to be decided at a meeting of the Board.

124. Defects in appointment of Directors not to invalidate actions taken All acts done by any meeting of the Board or by a Committee of the Board or by any person acting as a Director shall notwithstanding that it was subsequently noticed that there was some defect in the appointment of such Director or persons acting as aforesaid or that they or any of them were disqualified or had vacated office or that the appointment of any of them had been terminated by virtue of any provisions contained in the Act or these Articles be as valid as if every such person had been duly appointed and was qualified to be a Director and had not vacated his office or his appointment had not been terminated. PROVIDED that nothing in this Article shall be deemed to give validity to acts done by a Director after his appointment had been noticed by the Company to be invalid or to have terminated.

125. Minutes of proceedings of meetings of the Board (a) The Company shall cause minutes of all proceedings of every meeting of the Board and committee thereof to be kept by making within thirty days of the conclusion of every such meeting record thereof in Minute Book kept for that purpose with their pages consecutively numbered. (b) Each page of every such book shall be initialed or signed and the last page of the record of proceedings of each meeting in such book shall be dated and signed by the Chairman of the said meeting or the Chairman of the next succeeding meeting. The minute books of the Board and committee meetings shall be preserved permanently and kept in the custody of the company secretary of the company or any director duly authorized by the Board for the purpose and shall be kept in the registered office or such place as Board may decide. The minutes shall also contain - (i) the names of the Directors present at the meeting And (ii) in the case of each resolution passed at the

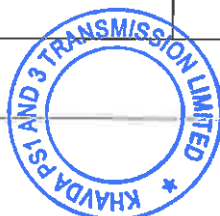

253

meeting the names of the Directors if any dissenting from or not concurring with the resolution. Nothing deemed to require the inclusion in any such minutes of any matter which in the opinion of the Chairman of the meeting (i) is or could reasonably be regarded as defamatory of any person, (ii) is irrelevant or immaterial to the proceedings or (iii) is detrimental to the interests of the Company. The Chairman shall exercise an absolute discretion in regard to the inclusion or non-inclusion of any matter in the minutes on the grounds specified in this sub-clause. (c) Minutes of meetings kept in accordance with the aforesaid provisions shall be evidence of the proceedings recorded therein.

126. Powers of Board The Board may exercise all such powers of the Company and do all such acts and things as it is entitled to do under section 179 of the Act and rules made thereunder or by the Memorandum or Articles of the Company but shall not decide matters required to be exercised or done by the Company in General Meeting Subject to these Articles no regulation made by the Company in General Meeting shall invalidate any prior act of the Board which would have been valid if that regulation had not been so made. Certain powers of the Board Without prejudice to the general powers conferred by the Act and preceding Article and so as not in any way to limit or restrict those powers and without prejudice to the other powers conferred by these Articles and by General Body it is hereby declared that the Directors shall have the following powers that is to say power-

- (1) to pay and charge to the capital account of the Company any commission or interest lawfully payable there out under the provisions of Sections 40 of the Act
- (2) Subject to Sections 179 and 180 of the Act to purchase or otherwise acquire for the Company any property rights or privileges which the Company is authorised to acquire at or for such price or consideration and generally on such terms and conditions as they may think fit and in any such purchase or other acquisition to accept such title as the Directors may believe or may be advised to be reasonably satisfactory
- (3) At their discretion and subject to the provisions of the Act to pay for any property rights or privileges acquired by or services rendered to the Company either wholly or partially in cash or in shares bonds debentures mortgages or other securities of the Company and any such shares may be issued either as fully paid-up or with such amount credited as paid-up thereon as may be agreed upon and any such bonds debentures mortgages or other securities may be either specially charged upon all or any part of the property of the Company and its uncalled capital or not so charged
- (4) To secure the fulfillment of any contract or engagement entered into by the Company in the normal course of business by mortgage or charge any of the property of the Company and its uncalled capital for the time being or in such manner as they may think fit
- (5) To accept from any Member as far as may be permissible by law a surrender of his shares or any part thereof on such terms and conditions as shall be agreed upon
- (6) To appoint any person to accept and hold in trust for the Company any property belonging to the Company in which it is interested or for any other purposes and to execute and do all such deeds and things as may be required in relation to any such trust and to provide for the remuneration of such trust or trustees
- (7) To institute conduct defend compound or abandon any legal proceedings by or against the Company or its officers or otherwise concerning the affairs of the Company and also to compound and allow time for payment or satisfaction of any debts due and of any claim or demand by or against the Company and to refer any differences to arbitration and observe and execute

67

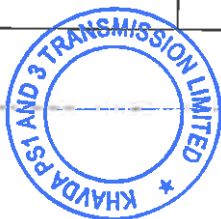

254

any awards made thereon(8) To act on behalf of the Company in all matters relating to bankruptcy and insolvency(9) To make and give receipts releases and other discharges for moneys payable to the Company and for the claims and demands of the Company(10) Subject to applicable provisions of the Act to invest and deal with any moneys of the Company not immediately required for the purposes thereof upon such security (not being shares of this Company) or without security and in such manner as they may think fit and from time to time to vary or realise such investments. Save as provided in Section 187 of the Act all investments shall be made and held in the Company's own name(11) To execute in the name and on behalf of the Company in favour of any Director or other person who may incur or going to incur any personal liability whether as principal or surety for the benefit of the Company such mortgages of the Company's property (present and future) as they think fit and any such mortgage may contain a power of sale and such other powers provisions covenants as shall be agreed upon(12) To open account with any bank or banks and to determine from time to time who shall be entitled to sign on the Company's behalf bills notes receipts acceptances endorsements cheques dividend warrants releases contracts and documents and to issue the necessary authority for such purpose(13) To distribute by way of bonus or commission amongst the staff of the Company on the profits of any particular business or transaction and to charge such bonus or commission as part of the working expense of the Company(14) To provide for the welfare of employees or ex-employees of the Company and their families or connections of such persons by building or contributing to the building of houses dwellings or chawls or by grants of money pension gratuities allowances bonus or other payments or by creating and from time to time subscribing or contributing to provident and other funds associations institutions or trusts and by providing or subscribing or contributing towards places of instruction and recreation hospitals and dispensaries medical and other attendance and other assistance as the Board shall think fit and to subscribe or contribute or otherwise to assist or to guarantee money to charitable benevolent religious scientific national or other institutions or objects which shall have any moral or other claim to support or aid by the Company either by reason of locality of operation or of public and general utility or otherwise(15) Before recommending any dividend to set aside out of the profits of the Company such sums as they may think proper for depreciation or to a Depreciation Fund or to an Insurance Fund or as a Reserve Fund or Sinking Fund or any Special Fund to meet contingencies or to repay debentures or debenture stock or for special dividends or for equalizing dividends or for repairing improving extending and maintaining any of the property of the Company and for such other purposes (including the purposes referred to in the preceding clause) as the Board may in their absolute discretion think conducive to the interest of the Company and subject to Section 179 of the Act to invest the several sums so set aside or so much thereof as required to be invested upon such investments (other than shares of the Company) as they may think fit and from time to time to deal with and vary such investments and dispose of and apply and expend all or any part thereof for the benefit of the Company in such manner and for such purposes as the Board in their absolute discretion think conducive to the interest of the Company notwithstanding that the matters to which the Board apply or upon which they expend the same or any part thereof may be matters to or upon



255

which the capital moneys of the Company might rightly be applied or expended and to divide the Reserve Fund or division or a reserve Fund to another Reserve Fund or division of a Reserve Fund and with full power to employ the assets constituting all or any of the above funds including the Depreciation Fund in the business of the Company or in the purchase or repayment of Debentures or debenture stock and without being bound to keep the same separate from the other assets and without being bound to pay interest on the same with power however to the Board at their discretion to pay or allow to the credit of such funds interest at such rate as the Board may think proper (16) To appoint and at their discretion remove or suspend such officers such as Executive Director general managers managers secretaries assistants supervisors clerks agents and servants etc. for permanent temporary or special services as they may from time to time think fit and to determine their powers and duties and fix their salaries or emoluments or remunerations and to require security in such instances and to such amounts as they may think fit. And also from time to time to provide for the management and transaction of the affairs of the Company in any specified locality in India or abroad in such manner as they think fit and the provisions contained in the following sub-clauses shall be without prejudice to the general powers conferred by this sub-clause (17) From time to time and at any time to establish any number of offices and establishments for properly managing the affairs of the Company in any specified locality in India or elsewhere and to appoint staff for such offices and to fix their remuneration (18) Subject to the provisions of the Act from time to time and at any time to delegate to any such local Board or any member or member thereof or any managers or agents so appointed or to any other person(s) any of the powers authorities and discretions for the time being vested in the Board and to authorise the members for the time being of any such local Board or any of them to fill up any vacancies therein and to act notwithstanding vacancies and any such appointment or delegation under the preceding and this sub-clause may be made on such terms and subject to such conditions as the Board may think fit and the Board may at any time remove any person so appointed and may annul or vary any such delegation (19) At any time and from time to time by Power of Attorney under the Seal of the Company to appoint any person or persons to be the Attorney or Attorneys of the Company for such purposes and with such powers authorities and discretions (not exceeding those vested in or exercisable by the Board under these presents and excluding the power to make calls and excluding also those which are to be exercised by the Board in its Meetings) and for such period and subject to such conditions as the Board may from time to time think fit and any such appointment may (if the Board thinks fit) be made in favour of the members or any of the members of any local Board established as aforesaid or in favour of any company or the shareholders directors nominees or managers or any company or firm or otherwise in favour of any persons whether appointed by name or designation by the Board and any such Power of Attorney may contain such powers for the protection or convenience of such Attorney as the Board may think fit and Board may specifically bestow powers enabling any such delegate or attorneys to sub-delegate all or any of the powers authorities and discretions for the time being vested in them (20) Subject to Sections 188 of the Act for or in relation to any of the matters aforesaid or otherwise for the purposes of the Company to enter into such negotiations and contracts and rescind and vary

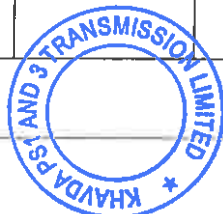

256

such contracts and execute and do all such acts deeds and things in the name and on behalf of the Company as they may consider expedient (21) From time to time to make vary and repeal bye-laws for the regulations of the business of the Company regulate employment of its officers and servants by making service Rules and Regulations (22) Maintain proper records at places as per provisions of the Act and where the Company has a branch office whether in or outside India the Company shall be deemed to have complied with this Article if proper Books of Account relating to the transactions effected at the branch office are kept at the branch office and proper summarized returns made up-to-date at intervals of not more than three months are sent by the branch office to the Company at its Office or other place in India at which the Company's Books of Accounts are kept as aforesaid (23) Ensure proper maintenance of the Books of Account which shall give a true and fair view of the state of the affairs of the Company or branch office as the case may be and explain its transactions. The Books of Account and other books and papers shall be open to inspection by any Director during business hours.

<input type="checkbox"/>	<input checked="" type="checkbox"/>	68	•
<input type="checkbox"/>	<input checked="" type="checkbox"/>	69	•
<input type="checkbox"/>	<input checked="" type="checkbox"/>	70	•
<input type="checkbox"/>	<input checked="" type="checkbox"/>	71	•
<input type="checkbox"/>	<input checked="" type="checkbox"/>	72	•
<input type="checkbox"/>	<input checked="" type="checkbox"/>	73	•
<input type="checkbox"/>	<input checked="" type="checkbox"/>	74	•
<input type="checkbox"/>	<input checked="" type="checkbox"/>	75	•
<input type="checkbox"/>	<input checked="" type="checkbox"/>	76	•

Chief Executive Officer, Manager, Company Secretary or Chief Financial Officer

<input type="checkbox"/>	<input checked="" type="checkbox"/>	77	<ul style="list-style-type: none"> 127. CEO MANAGER CS AND CFO Subject to the provisions of the Act --(i) A chief executive officer manager company secretary or chief financial officer may be appointed by the Board for such term at such remuneration and upon such conditions as it may think fit and any chief executive officer manager company secretary or chief financial officer so appointed may be removed by means of a resolution of the Board (ii) A director may be appointed as chief executive officer manager company secretary or chief financial officer As per provisions of the Act or these regulations requiring or authorising a thing to be done by or to a director and chief executive officer manager company secretary or chief financial officer shall not be satisfied by its being done by or to the same person acting both as director and as or in place of chief executive officer manager company secretary or chief financial officer.
--------------------------	-------------------------------------	----	--

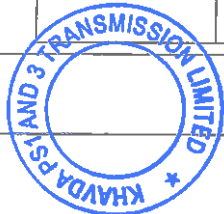

257

<input type="checkbox"/>	<input checked="" type="checkbox"/>	78	•
			<i>The Seal</i>
<input type="checkbox"/>	<input checked="" type="checkbox"/>	79	<ul style="list-style-type: none"> • 128. The Seal its custody and useThe Board shall provide a Common Seal for the purpose of theCompany and shall have power from time to time to destroy the same andsubstitute a new Seal in lieu thereof and the Board shall provide for the safecustody of the Seal for the time being and the seal shall never be used excepton the authority of the Board or by Committee of the Board as authorised.129. Deeds how executedEvery deed or other instrument to which the Seal of theCompany is required to be affixed shall unless the same is executed by a duly constitutedattorney Issued under the seal be signed by two Directors or one Director andSecretary or some other person authorised by the Board for the purpose PROVIDED that in respect of the Share Certificate the Sealshall be affixed in accordance with Article as mentioned above.
			<i>Dividends and Reserve</i>
<input type="checkbox"/>	<input checked="" type="checkbox"/>		<ul style="list-style-type: none"> • 130. Division of profits and dividends in proportion toamount paid-up(a) The profits of the Company subject to any specialrights relating thereto created or authorised to be created by these Articlesand subject to the provisions of these Articles shall be divisible among theMembers in proportion to the amount of capital paid-up or credited as paid-upon the shares held by them.(b) All dividends shall be apportioned and paidproportionately to the amounts paid or credited as paid on the shares heldduring any portion or portions of the period in respect of which the dividendis paid but if any share is issued on terms providing that it shall rank fordividend from a particular date such share shall rank for dividendaccordingly.131. The Company in General Meeting may declare a dividendCompany in General Meeting may declare dividends to be paidto Members according to their respective rights but no dividends shall exceedthe amount recommended by the Board but the Company in General Meeting maydeclare a smaller dividend.132. Dividends only to be paid out of Profits(a) No dividend shall be declared or paid by the Company forany financial year except out of Its profits for that year arrived at in themanner set out in Section 123 of the Act.(b) Where owing to inadequacy or absence of profits in anyfinancial year any Company proposes to declare dividend out of the accumulatedprofits earned by it in previous years and transferred by the company toreserves such declaration of dividend shall not be made except in accordancewith such rules as may be made in that behalf.(c) No dividend shall be declared or paid by a company fromits reserves other than free reserves.133. Interim DividendSubject to the provisions of Section 123 the Board mayfrom time to time pay the Members such Interim dividend as appear to it to bejustified by the profits of the Company.134. Capital paid - up in advance to carry InterestWhere capital is paid in advance of calls such capital maycarry interest but shall not in respect thereof confer a right to dividend orparticipate in profits.135. Retention of dividends until completion of transfer The Board may retain the dividends payable on shares in terms of Section 126 in respect of which any person is entitled to become aMember or on completion any person under those Articles is

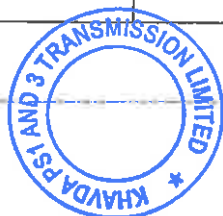

258

	80	<p>entitled to transfer or until such person shall become a Member in respect of such shares or shall duly transfer the same. 136. Transfer of shares must be Registered A transfer of shares shall not pass the right to any dividend declared thereon before the registration of transfer. Provided that where any instrument of transfer of shares has been delivered to the Company for registration and the transfer of such shares has not been registered by the Company it shall notwithstanding anything contained in any other provision of this Act) transfer the dividend in relation to such shares to the Unpaid Dividend Account referred to in Section 124 of the Act unless the Company is authorised by the registered holder of such shares in writing to pay such dividend to the transferee specified in such instrument of transfer and (b) keep in abeyance in relation to such shares any offer of rights shares under clause (a) of sub-section (1) of section 62 of the Act and any issue of fully paid-up bonus shares in pursuance of first proviso to sub-section (5) of section 123 of the Act. 137. No Member to receive dividend whilst indebted to the Company Companies right of reimbursement Thereon No Member shall be entitled to receive payment as interest or dividend in respect of his shares whilst any money may be due or owing from him to the Company in respect of such share or shares or otherwise howsoever either alone or jointly with any person or persons and the Board may deduct from the interest or dividend payable to any Member all sums of money so due from him to the Company. 138. Dividends how remitted (1) Unless otherwise directed any dividend payable in cash may be paid by cheque or warrant or in any electronic mode or by a pay slip or receipt or in any other manner having the force of a cheque or warrant sent through the post to the registered address of the Member or person entitled or in case of joint holders to that one of them first named in the Register in respect of the joint holdings. Every such cheque or warrant shall be made payable to the order of the person to whom it is sent the Company shall not be liable or responsible for any cheque or warrant or pay slip or receipt lost in transmission or for any dividend lost to the Member or person entitled thereto by the forged endorsement of any cheque or warrant or the forged signature of any pay slip or receipt or the fraudulent recovery of the dividend by any other means. (2) Notwithstanding anything contained in these Articles any dividend declared may be paid by Electronic Clearing System through any Sponsor Bank after getting registration with the Reserve Bank of India for using this facility and collecting from the members necessary bank mandate in the prescribed format. 139. Dividends and call together Any General Meeting declaring a dividend may on the recommendation of the Board make a call on the Members of such amount as the meeting may fix but so that the call on each Member shall not exceed the dividend payable to him and so that the call be made payable at the same time as the dividend and the dividend may if so arranged between the Company and the Member be set off against the calls. 140. Unclaimed dividend No unclaimed dividend shall be forfeited and all unclaimed dividends shall be dealt with in accordance with the provisions of Section 124 and other applicable provisions of the Act. 141. No interest against Dividend No dividend shall bear interest against the company.</p>
<input type="checkbox"/>	<input checked="" type="checkbox"/>	81



259

<input type="checkbox"/>	<input checked="" type="checkbox"/>	82	•
<input type="checkbox"/>	<input checked="" type="checkbox"/>	83	•
<input type="checkbox"/>	<input checked="" type="checkbox"/>	84	•
<input type="checkbox"/>	<input checked="" type="checkbox"/>	85	•
<input type="checkbox"/>	<input checked="" type="checkbox"/>	86	•
<input type="checkbox"/>	<input checked="" type="checkbox"/>	87	•
<input type="checkbox"/>	<input checked="" type="checkbox"/>	88	•
			Accounts
<input type="checkbox"/>	<input checked="" type="checkbox"/>	89	<ul style="list-style-type: none"> 142. Directors to keep true accounts(a) Every company shall prepare and keep at its registered office including its branch office or offices or at such other place in India as the Board thinks fit Books of Accounts and other relevant books and papers and financial statement for every financial year which give a true and fair view of the state of the affairs of the company in accordance with Section 128 of the Act with respect to-(i) all sums of money received and expended by the Company and the matters in respect of which the receipts and expenditure take place(ii) all sales and purchases of goods by the Company(iii) the assets and liabilities of the Company. (iv) state of affairs of the company.(b) Where the Board decides to keep all or any of the Books of Account at any place other than the Office of the Company the Company shall within seven days of the decision file with the Registrar a Notice in writing giving the full address of that other place in accordance with Section 128 of the Act.(c) The company may keep such books of account or other relevant papers in electronic mode in such manner as may be prescribed.(d) The Company shall preserve in good order the Books of Account relating to a period of not less than eight financial years immediately preceding a financial year. The books of account and other relevant books and papers maintained in electronic mode shall remain accessible in India so as to be usable for subsequent reference together with the vouchers relevant to any entry in such Books of Account.143. Inspection of accounts or record by members No Member (not being a director) shall have any right of inspecting any account or books or documents of the Company except as conferred by Section 94 of the Act or authorised by the Board or by the company in general meeting. The Board may determine whether and to what extent and at what time and place and under what conditions or regulations the accounts and books of the Company or any of them may be open to inspection of the Members. Notwithstanding anything to the contrary contained herein above the authorised representative of Promoters shall have a right to inspect the accounts books plant facility documents records premises equipment and machinery and all other property of the Company at convenient time(s) after giving advance notice to the Company.144. Statement of Accounts to be furnished to General Meeting The Directors shall from time to time in accordance with Sections 129 and 134 and other applicable provisions of the Act cause to be prepared and to be laid before the Company in



260

			<p>General Meeting such Balance Sheets Profit and Loss Accounts and Reports as are required by these Sections. 145. Copies shall be sent to each Member Without prejudice to the provisions of Section 101 and subject to the provisions of Section 136 of the Act a copy of the financial statements including consolidated financial statements auditors report and every other document required by law to be annexed or attached to the Balance Sheet shall at least twenty-one days before the General Body Meeting at which the same are to be laid before the members be sent to the members of the company to every trustee for every holder of any debenture issued by the company and to all persons other than such members or trustee being the persons entitled to attend the General Body Meeting. 146. Copy of financial statement to be filed with registrar The Company shall comply with Section 137 of the Act as to filing copies of the Balance Sheet and Profit and Loss Account and documents required to be annexed or attached thereto with the Registrar.</p>
			Winding up
<input type="checkbox"/>	<input checked="" type="checkbox"/>	90	<ul style="list-style-type: none"> 147. Procedure for winding up If the Company shall be wound up and the assets available for distribution among the members as such shall be insufficient to repay the whole of the paid up capital such assets shall be distributed so that as nearly as may be the losses shall be borne by the members in proportion to the capital paid up or which ought to have been paid up at the commencement of the winding-up on the shares held by them respectively. And if in a winding-up the assets available for distribution among the members shall be more than sufficient to repay the whole of the capital paid up at the commencement of the winding-up the excess shall be distributed amongst the members in proportion to the capital at the commencement of the winding-up paid up or which ought to have been paid up on the shares held by them respectively. But this Article is to be without prejudice to the rights of the holders of shares issued upon special terms and conditions. If the Company shall be wound up whether voluntarily or otherwise the liquidators may with the sanction of a Special Resolution divide among the contributions in specie or kind any part of the assets of the Company and may with the like sanction vest any part of the assets of the Company in Trustees upon such trusts for the benefit of the contributors or any of them as the liquidators with the like sanction shall think fit.
			Indemnity
<input type="checkbox"/>	<input checked="" type="checkbox"/>	91	<ul style="list-style-type: none"> 148. Officers to be indemnified Subject to provisions of the Act every Officer of the company shall be indemnified out of the assets of the Company against any liability incurred by him in defending any proceedings whether civil or criminal in which judgment is given in his favour or in which he is acquitted or in which relief is granted to him by the court or the Tribunal. Provided that if such person is proved to be guilty the premium paid on such insurance shall be treated as part of the remuneration.
			Others
			<ul style="list-style-type: none"> 149. Company not bound to recognize holding of shares on trust or

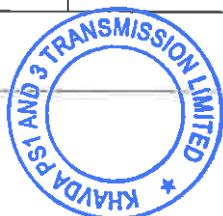

<input type="checkbox"/>	<input checked="" type="checkbox"/>	<p>any interest in shares other than that of registered holder Except as ordered by a Court of competent jurisdiction or as required by law the Company shall not be bound to recognize holding of any share upon any trust and to recognize any equitable contingent future or partial interest in any share or any interest in any fractional part of a share (except only as is by these Articles otherwise expressly provided) any right in respect of a share other than an absolute right thereto in accordance with these Articles in the person from time to time registered as the holder thereof but the Board shall be at liberty at their sole discretion to register any share in the joint names of any two or more persons or the survivor or survivors of them.</p> <p>150. Funds etc. of Company may not be applied in purchase of shares of the Company The Company shall not give either directly or indirectly and either by means of a loan guarantee the provision of security or otherwise any financial assistance for the purpose of or in connection with the purchase or subscription made or to be made by any person for purchase of any shares in the Company except in conformity with the provisions of Section 67 of the Act.</p> <p>151. Underwriting and Brokerage Commission may be paid Subject to the provisions of Section 40 of the Act the Company may at any time pay a commission to any person in consideration of his subscribing or agreeing to subscribe for any shares in or debentures of the Company or procuring or agreeing to procure subscriptions for any shares in or debentures of the Company but so that the commission shall not exceed in case of shares five percent of the price at which the shares are issued and in case of debentures two and a half percent of the price at which the debentures are issued. Such commission may be satisfied by payment in cash or by allotment of fully or partly paid shares or debentures or partly in one way and partly in the other.</p> <p>Brokerage The Company may also on any issue of shares or debentures pay such brokerage as may be lawful.</p> <p>152. Interest out of Capital Interest may be paid out of capital Where any shares are issued for the purpose of raising money to defray the expenses of the construction of any work or building or the provision of any plant which cannot be made profitable for a lengthy period the Company may pay interest on so much of that share capital as is for the time being paid up for the period at the rate and subject to the conditions and restrictions provided by the Company Act 2013 and may charge the same to capital as part of the cost of construction of the work or building or the provision of plant.</p> <p>153. Annual Returns The Company shall comply with the provisions of Sections 92 of the Act as to the making of Annual Returns.</p> <p>154. Borrowing powers As per the provisions of Section 73 76 179 180 and other applicable provisions of the Act the Board of Directors may from time to time at its discretion by resolution at a meeting of the Board and subject to the approval of the shareholders in General Meeting accept deposits from Members either in advance of calls or otherwise and generally raise or borrow or secure the payment of any sums of money for the purpose of the Company. Provided however where the moneys already borrowed (apart from temporary loans obtained from the Company's bankers in the ordinary due course of business) exceed the aggregate of the paid-up capital of the Company its free reserves (not being reserves set apart for any specific purpose) and the securities premium the Board shall not borrow such moneys without the consent of the Company in General Meeting. Payment or repayment of borrowed Moneys Subject to the provisions of Article 64 hereof the payment and repayment of moneys borrowed as aforesaid may be secured in</p>
--------------------------	-------------------------------------	---



262

such manner and upon such terms and conditions in all respects as the Board of Directors may think fit by resolutions passed at a meeting of the Board and in particular by the issue of bonds or debentures of the Company whether unsecured or secured by a mortgage or charge over all or any part of the property of the Company (both present and future) including its uncalled capital for the time being and debentures and other securities may be made assignable free from any equities between the Company and the person to whom the same may be issued. Terms of issue of Debentures Any debentures or other securities may be issued or otherwise and may be issued on condition that they shall be convertible into shares of any denomination and with any privileges and conditions to redemption surrender drawing allotment of shares and attending (but not voting) at General Meetings. Debentures with the right to conversion into or allotment of shares shall be issued only with the consent of the Company in General Meetings accorded by special resolution. Register of charges to be kept The Board shall cause a proper Register to be kept in accordance with the provisions of Section 85 of the Act of all charges and floating charges affecting the property or assets of the Company or any of its undertakings and shall cause the requirements of Sections 77 79 and 81 to 87 (both inclusive) of the Act in that behalf to be duly complied with so far as they are required to be complied with by the Board. Register of Debenture holders The Company shall if at any time it issues debentures keep a Register and Index of Debenture holders in accordance with Section 88 of the Act. The Company shall have the power to keep in any Country outside India a Register of Debenture holders residing outside India in such manner as may be prescribed. Application to Debentures and other securities The provisions of the Articles shall apply mutatis mutandis to debentures bonds or other securities issued by the company. 155. Dematerialization of Securities Definitions For the purpose of this Article Depository means a depository as defined in clause (e) of sub-section (1) of section 2 of the Depositories Act 1996. Beneficial Owner means a person or persons whose name is recorded in the Register maintained by a Depository under the Depository Act 1996. SEBI means the Securities and Exchange Board of India established under section 3 of the Securities Exchange Board of India Act 1992. Securities means the securities as defined in clause (h) of section 2 of the Securities Contracts (Regulation) Act 1956 Dematerialization of Securities Notwithstanding anything contained in these Articles the Company shall be entitled to dematerialize its existing securities rematerialize its securities held in the Depositories and or offer its fresh securities in dematerialized form pursuant to the provisions of the Depositories Act 1996 and the rules framed there under if any. Option for investors Every person subscribing to or holding securities of the Company shall have the option to receive securities certificates or to hold these securities with the Depository. Such a person who is the beneficial owner of the securities can at any time opt out of the Depository if permitted by the law in respect of any security in the manner and within the time prescribed issued to the beneficial owner the required certificate of the securities. If a person opts to hold his securities with a Depository the Company shall intimate such Depository the details of allotment of the security and on receipt of the information the depository shall enter in its records the name of the allottees as the beneficial owner of the securities. Securities in Depository to be in Fungible Form All securities held by a Depository shall be dematerialized and be in

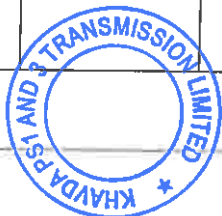

263

fungible form. Nothing contained in Section 88 89 112 and 186 of the Act shall apply to a Depository in respect of the securities held by it on behalf of the Beneficial Owners. Rights and Liabilities of Beneficial Owner (a) Notwithstanding anything to the contrary contained in the Act or these Articles a Depository shall be deemed to be the registered owner for the purposes of effecting transfer of ownership of security on behalf of the beneficial owners. (b) Save as otherwise provided in (a) above the Depository as the registered owner of the securities shall not have any voting rights or any other rights in respect of the securities held by it. (c) Every person holding securities of the Company and whose name is entered as the beneficial owner in the records of the Depository shall be deemed to be a member of the Company. The beneficial owner of securities shall be entitled to all the rights and benefits and be subject to all the liabilities in respect of his securities which are held by a Depository. Service of Documents Notwithstanding anything to the contrary contained in the Act or Articles to the contrary where securities are held in a Depository the records of the beneficial ownership may be served by such Depository on the Company by means of electronic mode or by delivery of floppies or discs. Provisions of Articles to apply to shares held in Depository Nothing contained in Section 56 of the Act or these Articles shall apply to a transfer of securities effected by a transferor and transferee both of whom are entered as beneficial owners in the records of a Depository. Allotment of Securities dealt with in a Depository Notwithstanding anything in the Act or these Articles where securities are dealt with by the Depository the Company shall intimate the details thereof to the Depository immediately on allotment of such securities. Distinctive numbers of securities held in the depository Mode Nothing contained in the Act or these Articles regarding the necessity of having distinctive numbers on securities issued by the Company shall apply to securities held with a Depository. Register and Index of Beneficial Owners The Register and Index of Beneficial Owners maintained by a Depository under the Depositories Act 1996 shall be deemed to be the Register and Index of member and security holder for the purpose of these Articles. 156. Conversion of Shares into Stock and Reconversion Shares may be converted into stock and reconverted The Company in General Meeting may convert any paid up shares into stock and when any shares shall have been converted into stock these several holders of such stock may henceforth transfer their respective interest therein or any part of such interest in the same manner and subject to the same regulations as if no such conversion had taken place or as near thereto as circumstances will admit. The Company may at any time reconvert any stock into paid-up shares. Rights of stock holders The holders of stock shall according to the amount of stock held by them have the same rights privileges and advantages as regards dividends voting at meetings of the Company and other matters as if they held the shares from which the stock arose 157. Audit Accounts to be audited The Auditors of the Company shall be appointed or reappointed by the Comptroller and Auditor General of India and their remuneration rights and duties shall be regulated by Section 139 to 143 and 145 to 148 of the Act. Powers of the Comptroller and Auditor General of India. The Comptroller and Auditor General of India shall have the powers - (a) to direct the manner in which the Company's accounts shall be audited by the auditors appointed in pursuance of Article hereof and to give such auditors instruction in regard to any matter relating to the performance of their functions as such. (b) to conduct a

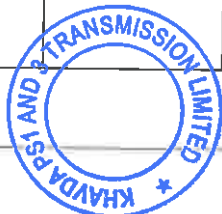

supplementary or test audit of the financial statement of the Company by such person or persons as he may authorize in this behalf and for the purposes of such audit to have access at all reasonable times to all accounts account books vouchers documents and other papers of the Company and to require information or additional information to be furnished to any person or persons so authorized on such matters by such person or persons and in such form as the Comptroller and Auditor General may by general or special order direct. Comments upon or supplement to audit report by the Comptroller Auditor General of India to be placed before the annual general meeting. The auditors aforesaid shall submit a copy of his her audit report to the Comptroller and Auditor General of India who shall have the right to comment upon or supplement such audit report in such manner as he may think fit. Any such comments upon or supplement to the audit report shall be placed before the Annual General Meeting of the Company at the same time and in the same manner as the audit report. 158.

Service of Documents
Manner of Service of Documents
A document or notice may be served or given by the Company to any Member either through speed post registered post or through electronic mode to his registered address or (if he has no registered address in India) to the address if any in India supplied by him to the Company for serving documents or notices on him. Notices to be sent by the company through its authorized and secured computer programme which is capable of producing confirmation and keeping record of such communication addressed to the person entitled to receive such communication at the last electronic mail address provided by the member. The notice may be sent through e-mail as a text or as an attachment to e-mail or as a notification providing electronic link or Uniform Resource Locator for accessing such notice through in-house facility or its registrar and transfer agent or authorise any third party agency providing bulk e-mail facility. When notices or documents served on Members Where a document or notice is sent by post service of the document or notice shall be deemed to be effected by properly addressing prepaying and posting a letter containing the document or notice. When notice or notifications of availability of notice are sent by e-mail the company should ensure that it uses a system which produces confirmation of the total number of recipients e-mailed and a record of each recipient to whom the notice has been sent and copy of such record and any notices of any failed transmissions and subsequent re-sending shall be retained by or on behalf of the company as proof of sending. Provided that the member shall provide the updated email address to the company and for that company will provide an advance opportunity at least once in a financial year to the member to register his e-mail address and changes therein and such request may be made by only those members who have not got their email id recorded or to update a fresh email id. Notice will also be simultaneously updated in the website of the company.

By Advertisement
A document or notice advertised in a newspaper circulating in the neighborhood of the Registered Office shall be deemed to be duly served or sent on the day on which the advertisement appears on or to every Member who has no registered address in India and has not supplied to the Company an address within India for the serving of documents on sending the notices to him. Explanatory Statement of material facts under Section 102 need not be advertised but it will be mentioned in the advertisement that the Statement has been forwarded to the Members. On personal representatives etc. A document or notice

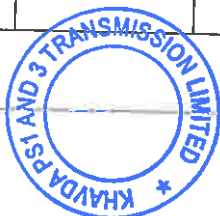

265

may be served or given by the Company or to the persons entitled to a share in consequence of the death or insolvency of a Member by sending it through the post in prepaid letter addressed to them by name or by the title of representative of the deceased or assignee of the insolvent or by any like description at the address (if any) in India supplied for the purpose by the persons claimed to be entitled or until such an address has been so supplied by serving the document or notice in any manner in which the same might have been given if the death or insolvency had not occurred. To whom documents or notices must be served or given Documents or notices of every General Meeting shall be served or given in same manner as herein before or to (a) every member of the company legal representative of any deceased member or the assignee of an insolvent member (b) the auditor or auditors of the company and (c) every director of the company. Members bound by documents or notices served on or given to previous holders Every person who by operation of law transfer or other means whatsoever shall become entitled to any share shall be bound by every document or notice in respect of such share which previously to his name and address being entered in the Register of Members shall have been duly served on or given to the person from whom he derives his title to such shares Documents or notice by Company and signature thereto Any document or notice to be served or given by the Company may be signed by a director or key managerial personnel or an officer of the company duly authorised by the Board in this behalf. Service of document or notice by Member All documents or notices to be served or given by Members on or to the Company or any officer thereof shall be served or given by sending it to the Company or Officer at the Office by post or through electronic mode under a certificate of posting or by registered post or through email. 159. Secrecy (a) Every Director Manager Auditor Treasurer Trustee member of a committee officer servant agent accountant or other person employed in the business of the Company shall if so required by the Directors before entering upon his duties sign a declaration pledging himself to observe strict secrecy respecting all transactions and affairs of the Company with the customers and the state of the accounts with individuals and in matters relating thereto and shall by such declaration pledge himself not to reveal any of the matters which may come to his knowledge in the discharge of his duties except when required so to do by the Directors or by law or by the person to whom such matters relate and except so far as may be necessary in order to comply with any of the provisions in these presents contained. (b) No Member shall be entitled to visit or inspect any work of the Company without the permission of the Directors or to require discovery of or any information respecting any details of the Company's trading or any matter which is or may be in the nature of a trade secret mystery of trade secret process or any other matter which may relate to the conduct of the business of the Company and which in the opinion of the Directors it would be expedient in the interest of the Company to disclose. 160. Copies of Memorandum and Articles of Association to be sent by the Company Copies of the Memorandum and Articles of Association of the Company and other documents referred to in Section 17 of the Act shall be sent by the Company to every Member at his request within seven days of the request on payment of such fees as may be prescribed.

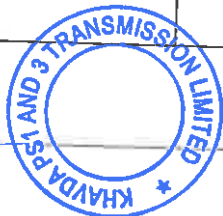

266

Subscriber Details

S. No.	Subscriber Details				
	*Name, Address, Description and Occupation	DIN / PAN / Passport number	*Place	DSC	Dated
1	M/s PFC Consulting Limited having its registered office at Urjanidhi, 1, Barakhamba Lane, Connaught Place, New Delhi-110001 Through Sh. Sachin Arora S/o Sh. Prem Lal Arora R/o F5 1903, Supertech Eco Village 1, Near Park, Greater Noida 201301 (as authorized representative of PFC Consulting Limited)	AKGPA1434J	New Delhi	Sachin Arora <small>Digitally signed by Sachin Arora Date: 2023.12.18 18:00:09 +05:30'</small>	18/12/2023
2	SACHIN SHUKLA S/o Sh. Raj Kumar Shukla R/o 4th Floor, House No. 6, H1 Block, Good Earth City Centre, south City 2, Gurgaon - 122018 (As a Nominee of PFC Consulting Limited) Occupation:- Service	08613963	New Delhi	Sachin Shukla <small>Digitally signed by Sachin Shukla Date: 2023.12.18 17:08:57 +05:30'</small>	18/12/2023
3	SANJAY KUMAR NAYAK S/o Sh. Jagabandhu Nayak R/o K 713, Jalvayu Tower, Sector 56 Gurgaon- Haryana 122011 (As a Nominee of PFC Consulting Limited) Occupation:- Service	08197193	New Delhi	Sanjay Kumar Nayak <small>Digitally signed by Sanjay Kumar Nayak Date: 2023.12.18 18:00:09 +05:30'</small>	18/12/2023
4	MANOJ KUMAR RANA S/o Sh. Sube Singh R/o A-32/E, DDA Flats, Munirka, New Delhi-110067 (As a Nominee of PFC Consulting Limited) Occupation:- Service	02263302	New Delhi	Manoj Kumar Rana <small>Digitally signed by Manoj Kumar Rana Date: 2023.12.18 18:00:21 +05:30'</small>	18/12/2023
5	MILIND MADHUSUDAN DAFADE S/o Sh. Madhusudan Gurinath Dafade R/o Aishwaryam Appt., Flat C-31, Sec-4, Plot No. 17, Dwarka, New Delhi-110078 (As a Nominee of PFC Consulting Limited) Occupation:- Service	09587967	New Delhi	MILIND MADHUSUDAN DAFADE <small>Digitally signed by MILIND MADHUSUDAN DAFADE Date: 2023.12.18 17:08:58 +05:30'</small>	18/12/2023
6	RISHAB JAIN S/o Sh. Naveen Jain R/o T-11, first floor, Green Park Extension, New Delhi, 110016 (As a Nominee of PFC Consulting Limited) Occupation:- Service	08485361	New Delhi	Rishab Jain <small>Digitally signed by Rishab Jain Date: 2023.12.18 17:08:58 +05:30'</small>	18/12/2023
7	NEERAJ SINGH S/o Sh. Dayashankar Singh R/o Flat C-703, The Crescent Apartment, Plot F-2, Sector-50, Noida, Gautam Budh Nagar, UP-201301 (As a Nominee of PFC Consulting Limited)	08613892	New Delhi	Neeraj Singh <small>Digitally signed by Neeraj Singh Date: 2023.12.18 18:00:21 +05:30'</small>	18/12/2023

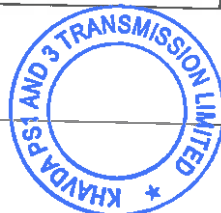

267

Occupation:- Service

Signed before me

Name Prefix (ACA/FCA/ACS/ FCS/ACMA/ FCMA)	*Name of the witness	*Address, Description and Occupation	*DIN / PAN / Passport number / Membership		DSC	Dated
FCS	Naresh Kumar Sinha	121, Vinayak Apartment, C58/19, Sector-62, Noida-201307, UP	1807	Noida	<small>Digitally signed by NARESH KUMAR DIN# 1807</small>	18/12/2023

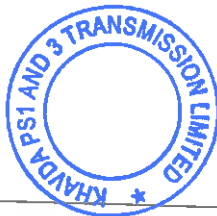

268





Dated: Sept 18, 2024

CERTIFICATE BY THE BID EVALUATION COMMITTEE

Sub.: Selection of Successful Bidder as Transmission Service Provider to establish "Provision of Dynamic Reactive Compensation at Khavda Pooling Station 1 (KPS1) and Khavda Pooling Station 3 (KPS3)".

It is hereby certified that:

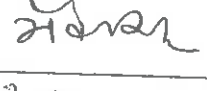
1. The entire bid process has been carried out in accordance with the "Tariff based Competitive Bidding Guidelines for Transmission Service" and "Guidelines for encouraging competition in development of the Transmission Projects" issued by Ministry of Power, Govt. of India under Section 63 of the Electricity Act, 2003 and as amended from time to time.
2. **Power Grid Corporation of India Limited** emerged as the Successful Bidder after the conclusion of e-reverse bidding process with the lowest Quoted Transmission Charges of **Rs.1,077.25 million per annum**.
3. The quoted tariff is higher than the Levelised Tariff calculated based on CERC norms considering the Capital Cost for the Project 'Provision of Dynamic Reactive Compensation at Khavda Pooling Station 1 (KPS1) and Khavda Pooling Station 3 (KPS3)' as assessed by Cost Committee. The quoted tariff discovered through e-reverse bidding process is acceptable.

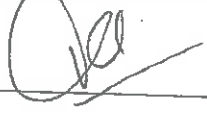
Name of Committee Member	Signature
Shri. Rajesh Kumar Singh, General Manager, SBI Commercial Client Group Regional office - II New Delhi - Chairman	
Shri. Deepak Gawali, Superintending Engineer (Operation), WRPC - Member	
Shri. S.M. Soni, Superintending Engineer, GETCO - Member	
Shri. Bhanwar Singh Meena, Director (PSE&TD), CEA - Member	
Shri. B. S. Bairwa, Chief Engineer, PSPA-II Division, CEA - Member	
Shri. Neeraj Singh, Chairman, Khavda PS1 and 3 Transmission Limited, New Delhi - Convener Member	



269

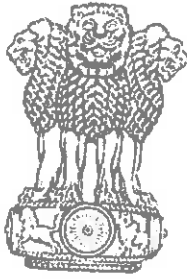

सत्यमेव जयते

INDIA NON JUDICIAL

Government of National Capital Territory of Delhi

e-Stamp

Certificate No.	: IN-DL82559008958238W
Certificate Issued Date	: 07-Nov-2024 04:52 PM
Account Reference	: IMPACC (IV)/ dl1074803/ DELHI/ DL-DLH
Unique Doc. Reference	: SUBIN-DL DL107480313831165548975W
Purchased by	: KHAVDA PSI AND 3 TRANSMISSION LIMITED
Description of Document	: Article Others
Property Description	: Not Applicable
Consideration Price (Rs.)	: 0 (Zero)
First Party	: KHAVDA PSI AND 3 TRANSMISSION LIMITED
Second Party	: Not Applicable
Stamp Duty Paid By	: KHAVDA PSI AND 3 TRANSMISSION LIMITED
Stamp Duty Amount(Rs.)	: 100 (One Hundred only)

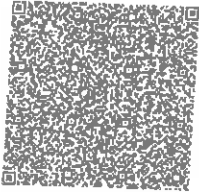
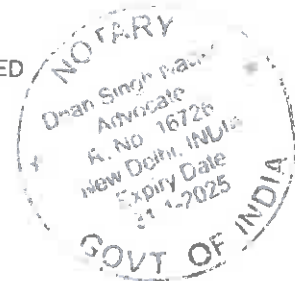

General Power of Attorney

Know all men by these presents, we **Khavda PS1 and 3 Transmission Limited** (hereinafter referred to as **KPS1&3TL** which expression shall unless repugnant to the context or meaning thereof, include its successors, administrators, and assigns) having its Registered Office at B-9, Qutab Institutional Area, Katwaria Sarai, New Delhi – 110 016 do hereby constitute, appoint and authorize **Ms. Khushboo Jain**, Finance Incharge of KPS1&3TL residing at Block C-7, Flat No. 403, PWD Apartments, Sector 43, Gurgaon -122001 as our true and lawful attorney, to do in our name and our behalf, all of the acts or things hereinafter mentioned, that is to say:-

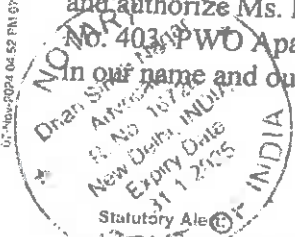

Handwritten signature

270

The authenticity of this Stamp certificate should be verified at www.shikastamp.com or using e-stamp mobile app. Any discrepancy in the details on this Certificate and as available on the website / Mobile App renders it invalid. The onus of checking the legitimacy is on the users of the certificate. In case of any discrepancy please inform the Competent Authority.

1. To constitute, and defend legal cases, sign and verify plaints, written statements, petitions and objections, memorandum of appeal, claims, affidavits, applications, re-applications and pleadings of all kinds and to file them in Central Electricity Regulatory Commission (CERC), State Electricity Regulatory Commissions (SERCs), Appellate Tribunal for Electricity (ATE), Civil, Criminal or Revenue courts, Arbitration, Labour Court, Industrial Tribunal, High Court and Supreme Court, whether having original or appellate jurisdiction and before Government or Local Authorities or Registration Authorities, Tax Authorities, Tribunals, etc.
2. To appear, before various Courts / Tribunals / CERC / SERCs / Appellate Tribunal for Electricity.
3. To appoint any Advocate, Vakil, Pleader, Solicitor or any other legal practitioner as Attorney to appear and conduct case proceedings on behalf of the company and to sign Vakalatnama.
4. To compromise, compound or withdraw cases from any Court / Tribunal / CERC / SERCs / Appellate Tribunal for Electricity.
5. To file petitions/applications or affidavits before the Supreme Court / High Court / CERC / SERCs / Appellate Tribunal for Electricity and to obtain the copies of documents, papers, records etc.
6. To file and receive back documents, to deposit and withdraw money from Courts, Tribunal, Registrar's Office and other Government or Local Authorities and to issue valid receipts thereof.
7. To apply for and obtain refund of stamp duty or court fee, etc.
8. To issue notices and accept service of any summons, notices or orders issued by any Court / Tribunal / CERC / SERCs / Appellate Tribunal for Electricity on behalf of the Company.
9. To execute deeds, agreements, bonds and other documents and returns in connection with the affairs of the company and file them or cause to be filed for Registration, whenever necessary.
10. To issue Project Authority Certificate(s) in respect of contracts for Load Despatch & Communication Systems, Transmission Systems etc. and to lodge claims with the Railways, Transporters, Shipping Agents and Clearing Agents and to settle/compromise such claims.
11. To lodge claims with the Insurance companies, to settle/compromise such claims and on satisfactory settlement thereof, to issue letters of subrogation/power of attorney in favour of Insurance companies.
12. To execute, sign and file applications, undertakings, agreements etc. to or with the Central / State Government(s) / Body(ies) to obtain 'right of way' or any of other Right(s) / Privilege(s) etc.
13. To execute, sign and file applications, undertakings, agreements, bills, documents etc. to or with the Central / State Government(s) / Body(ies) and other authorities / entities including Transmission Utility (CTU)/Power System Operation Corporation Limited (PSOC) / Central Electricity Authority (CEA)/ CERC with respect to Commissioning

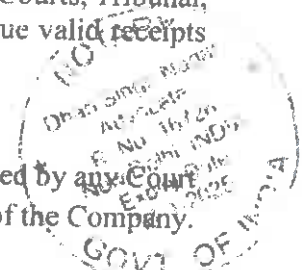

Handwritten signature and initials in blue ink.

Handwritten number '271' in blue ink.

of the Project, realization of Transmission charges, to obtain 'right of way' or any of other Right(s) / Privilege(s) etc.

14. To execute Transmission Service Agreement (TSA) with Central Transmission Utility of India Limited (CTUIL)
15. To execute Consultancy, Funding and other Agreements.
16. To act as administrator for e-filing process with CERC and other Statutory authorities.
17. Generally to do all lawful acts, necessary for the above mentioned purposes.

The Company hereby agrees to ratify and confirm all and whatsoever the said Attorney shall lawfully do execute or perform or cause to be done, executed or performed in exercise of the power or authority conferred under and by virtue of this Power of Attorney.

.....
Signed by the within named
Khavda PS1 and 3 Transmission Limited
through the hand of
Duly authorized by the Board to issue such Power of Attorney

Dated this 07th day of November, 2024

Accepted

.....
Signature of Attorney

Name: Ms. Khushboo Jain

Designation: Finance Incharge, **Khavda PS1 and 3 Transmission Limited**

Address: Block C-7, Flat No. 403, PWO Apartments, Sector 43, Gurgaon -122001

Attested

.....
(Signature of the Executant)

Name: Pankaj Pandey

Designation: Director

Address: B-9, Qutab Institutional Area, Katwaria Sarai, New Delhi - 110 016

.....
Signature and Stamp of Notary of the place of execution

WITNESS

ATTESTED

NOTARY PUBLIC
NEW DELHI (INDIA)

07 NOV 2024

232

