

12	Copy of the relevant extract of Request for Proposal (RFP) along with letters from BPC	Annexure-4	32-35
13	Copy of Share purchase agreement (SPA)	Annexure-5	36-55
14	Copy of Transmission Service Agreement (TSA)	Annexure-6	56-308
15	Copy of SLD of the transmission scheme	Annexure-7	309-309
16	Form-1 for Transmission License with the following enclosures: a) Certificate of Registration, Memorandum of Association and Articles of Association: Enclosure-1 b) Certificate of Bid Evaluation Committee as furnished by BPC: Enclosure-2 c) Copy of Power of Attorney: Enclosure-3	Annexure-8	310-348

Amith Jain

FILED BY

KHAVDA V-A POWER TRANSMISSION LIMITED

Place: New Delhi

Date: 22.11.2024



KHAVDA V-A POWER TRANSMISSION LIMITED

(A 100% wholly owned subsidiary Power Grid Corporation of India Limited)

B-9, Qutab Institutional Area, Katwaria Sarai, New Delhi - 110 016

CIN : U42202DL2023GOI421022

Ref: PG_KVAPTL/

Dated : 22.11.2024

To,
The Secretary,
Central Electricity Regulatory Commission,
7th Floor, Tower B, World Trade Centre,
Nauroji Nagar, New Delhi-110029.

Sub.: Application under Section 14 & 15 of the Electricity Act, 2003 read with Central Electricity Regulatory Commission (Procedure, Terms and Conditions for Grant of Transmission License and other related matters) Regulations, 2024 with respect to Transmission License to KHAVDA V-A POWER TRANSMISSION LIMITED

Sir,

Three copies (1 original + 2 copies) of the application for the above subject matter have been enclosed and e-filing has been done on CERC website. As per the public notice issued on 28.08.2010 by the Hon'ble Commission the amount of Rs. 1,00,000/- (Rupees One Lakhs only) for filing the application has been paid through RTGS and in accordance with the Regulations 12 (2), Payment of Fees Regulations 2012, Form-1 duly filled in against the aforementioned application is also enclosed herewith.

Electronic Copies of the application are being forwarded to the CTUIL (Nodal Agency), the Bid Process Coordinator, beneficiaries of the Western Region and DICs. The complete application along with Annexure is posted on the website: www.powergrid.in/subsidiaries.

Thanking You,

Yours faithfully,



(Amit Kumar Jain)

Finance Incharge

KHAVDA V-A POWER TRANSMISSION LIMITED

Mobile: +91- 9971492658 ; email : tbcb@powergrid.in

Enclosures: As above



(iv)

Form-I

Particulars

1. Name of the Petitioner : **KHAVDA V-A POWER TRANSMISSION LIMITED**
(A 100% wholly owned subsidiary of
Power Grid Corporation of India Limited)
2. Address of the Petitioner/Applicant : **KHAVDA V-A POWER TRANSMISSION LIMITED**
(A 100% wholly owned subsidiary of
Power Grid Corporation of India Limited)
Regd. Address:
B-9, Qutab Institutional Area,
Katwaria Sarai, New Delhi-110 016
Address for correspondence:
Finance Incharge, KHAVDA V-A POWER
TRANSMISSION LIMITED, C/o ED (TBCB), Power
Grid Corporation of India Ltd, Saudamini, Plot no.2,
Sector - 29, Gurgaon 122001
3. Subject Matter : Application under Section 14 & 15 of the Electricity
Act, 2003 read with Central Electricity Regulatory
Commission (Procedure, Terms and Conditions for
Grant of Transmission License and other related
matters) Regulations, 2024 with respect to
Transmission License to KHAVDA V-A POWER
TRANSMISSION LIMITED
4. Petition No., if any : Not yet received
5. Details of generation assets : NOT APPLICABLE
(a) generating station/units
(b) Capacity in MW
(c) Date of commercial operation
(d) Period for which fee paid
(e) Amount of fee paid
(f) Surcharge, if any
6. Details of transmission assets : Assets under implementation by
Transmission line and sub-stations **KHAVDA V-A POWER TRANSMISSION LIMITED**
(b) Date of commercial operation
(c) Period for which fee paid
(d) Amount of fee paid
(g) Surcharge, if any
7. Fee paid for Adoption of tariff for : NOT APPLICABLE
(a) Generation asset
(b) Transmission asset



(iv)

Agan

8. Application fee for licence :
(a) Trading licence : NO
(b) Transmission licence : YES
(c) Period for which paid : NOT APPLICABLE
(d) Amount of fee paid : Rs.1,00,000/- only

9. Fees paid for Miscellaneous Application : NOT APPLICABLE

10. Fees paid for Interlocutory Application : NOT APPLICABLE

11. Fee paid for Regulatory Compliance petition : NOT APPLICABLE

12. Fee paid for Review Application : NOT APPLICABLE

13. Licence fee for inter-State Trading : NOT APPLICABLE
(a) Category
(b) Period
(c) Amount of fee paid
(d) Surcharge, if any

14. Licence fee for inter-State Transmission : NOT APPLICABLE
(a) Expected/Actual transmission charge
(b) Period
(c) Amount of fee calculated as a percentage of transmission charge.
(d) Surcharge, if any

15. Annual Registration Charge for Power Exchange : NOT APPLICABLE
(a) Period
(b) Amount of turnover
(c) Fee paid
(d) Surcharge, if any

16. Details of fee remitted

(a) UTR No. : CMS001576383791
(b) Date of remittance : 22.11.2024
(c) Amount remitted : Rs.1,00,000 (Rupees One Lakh only)



Shivkumar Jain

Signature of the authorized signatory with date

BEFORE
THE CENTRAL ELECTRICITY REGULATORY COMMISSION
NEW DELHI

Petition No.: -----

IN THE MATTER OF: Application under Section 14 & 15 of the Electricity Act, 2003 read with Central Electricity Regulatory Commission (Procedure, Terms and Conditions for Grant of Transmission License and other related matters) Regulations, 2024 with respect to Transmission License to KHAVDA V-A POWER TRANSMISSION LIMITED

MEMO OF APPEARANCE

KHAVDA V-A POWER TRANSMISSION LIMITED --- PETITIONER

1. Pankaj Pandey, ED, POWERGRID
2. Amit Kumar Jain, Finance Incharge, KHAVDA V-A POWER TRANSMISSION LIMITED
3. Ashwini Kumar Das, GM, POWERGRID

Filed by
KHAVDA V-A POWER TRANSMISSION LIMITED
Represented by

Place: New Delhi

Date: 22.11.2024

Amit Kumar Jain
Finance Incharge
(KHAVDA V-A POWER TRANSMISSION LIMITED)



Rohit Jain {रोहित जैन}

From: Rohit Jain {रोहित जैन}
Sent: 26 November 2024 20:33
To: tbc; cecomcseb@rediffmail.com; Manoj.K@cspc.co.in; eediv3@yahoo.co.in; decsp.guvnl@gebmail.com; aocom2.guvnl@gebmail.com; dksingh@mum.hwb.gov.in; dksingh1164@yahoo.com; wr1commercial@powergrid.co.in tripat_m@powergrid.in; wr1commercial@powergrid.co.in tripat_m@powergrid.in; rajvarman.saxena@mppmcl.com; comml.deptt@mppmcl.com; gmppmsedcl@gmail.com; ceppmsedcl@gmail.com; acbpower@acbindia.com; lopamudra.kashyap@acbindia.com; satyanarayansoni@torrentpower.com; Niralishah@torrentpower.com; oa_commercial.seil@sembcorp.com spotsales.india@sembcorp.com; electricitybill@barctara.gov.in craman@barc.gov.in; Pramod.Khandelwal@gmrgroup.in Santu.Pal@gmrgroup.in; wr1commercial@powergrid.co.in tripat_m@powergrid.in; dyceetrdwcr@gmail.com; cede@wr.railnet.gov.in; sales@dbpower.in sanjay.jadhav@dbpower.in; ce.techcell@gmail.com Manoj.K@cspc.co.in; acbpower@acbindia.com; lopamudra.kashyap@acbindia.com; hitesh.modi@adani.com Nilanjan.Chakraborty@adani.com; naresh.yadav@amns.in; cesecrly@gmail.com dyceetrdcrly@gmail.com; bhavikshah@torrentpower.com; namanshah@torrentpower.com; rajesh.sirigirisetty@adani.com; Prasanta Kumar Mahalik {पी.के. महालिक}; tbc@recpdcl.in; RECPDCL Satyabhan Sahoo Sir; akvaishnav@gipcl.com; rajesh.gupta@adani.com; mahendrasingh.dabi@adani.com; Kashish Bhambhani {कशिश भम्भानी}; Swapnil Verma {स्वप्निल वर्मा}; Anil Kr Meena {अनिल कुमार मीना}
Cc: Pankaj Pandey {पंकज पाण्डेय}; Ashwini Kr Das {अश्विनी कुमार दास}; Lingolu Aditya Mahesh {लिंगोलु आदित्य महेश}; Vikas Kumar {विकास कुमार}
Subject: Khavda V-A Power Transmission Limited: Application under Section 14 & 15 of the Electricity Act, 2003 for Grant of Transmission License
Attachments: GoTL_Sec14_Khavda_V-A_Email.PDF

Dear Sir/Mam,

The following application is being filed before CERC:

Application under Section 14 & 15 of the Electricity Act, 2003 read with Central Electricity Regulatory Commission (Procedure, Terms and Conditions for Grant of Transmission License and other related matters) Regulations, 2024 with respect to Transmission License to Khavda V-A Power Transmission Limited

The soft copy of this application is attached with this mail for your kind information and necessary action please.

With Regards,

Khavda V-A Power Transmission Limited

(VAT)



**BEFORE THE CENTRAL ELECTRICITY REGULATORY COMMISSION
NEW DELHI**

**Application under Section 14 & 15 of the Electricity Act, 2003 read with
Central Electricity Regulatory Commission (Procedure, Terms and
Conditions for Grant of Transmission License and other related matters)
Regulations, 2024 with respect to Transmission License to KHAVDA V-A
POWER TRANSMISSION LIMITED**

APPLICATION NO :.....

KHAVDA V-A POWER TRANSMISSION LIMITED
(A 100% wholly owned subsidiary of Power Grid Corporation of India Limited)

Registered office:

B-9, Qutab Institutional Area, Katwaria Sarai, New Delhi - 110 016

Address for Correspondence:

C/o ED (TBCB), Power Grid Corporation of India Limited
Saudamini, Plot no.2, Sector -29, Gurgaon 122001



Agarwal

BEFORE THE HON'BLE CENTRAL ELECTRICITY REGULATORY COMMISSION
NEW DELHI

IN THE MATTER OF

APPLICATION No :.....

Application under Section 14 & 15 of the Electricity Act, 2003 read with Central Electricity Regulatory Commission (Procedure, Terms and Conditions for Grant of Transmission License and other related matters) Regulations, 2024 with respect to Transmission License to KHAVDA V-A POWER TRANSMISSION LIMITED

KHAVDA V-A POWER TRANSMISSION LIMITED

(A 100% wholly owned subsidiary of Power Grid Corporation of India Limited)

Registered office: B-9, Qutab Institutional Area, Katwaria Sarai, New Delhi 110 016

Address for correspondence: C/o ED (TBCB), Power Grid Corporation of India Limited, Saudamini, Plot no.2, Sector -29, Gurgaon 122001

AND

Chief Operating Officer,
Central Transmission Utility of India Ltd,
Saudamini, Plot no.2, Sector -29,
Gurgaon 122001.....

RESPONDENT(S)

And Others

INDEX

Sl. No	Description	Annexure No.	Page No.
1.	Letter for registration	-	4
2.	Memo of parties	-	5-8
3.	Affidavit	-	9-10
4.	Application	-	11-18
5.	Extract of Gazette notification no. 3733 No. 15/3/2018-Trans-Pt(1) dated 04.09.2023 has notified REC Power Development and Consultancy Limited to be the Bid Process Coordinator (BPC)	Annexure-1	19-21
6.	Extract of the RFP document as provided by BPC	Annexure-2	22-23
7.	Copy of Letter of Intent (LoI)	Annexure-3	24-31
8.	Copy of the relevant extract of Request for Proposal (RFP) along with letters from BPC	Annexure-4	32-35
9.	Copy of Share purchase agreement (SPA)	Annexure-5	36-55
10.	Copy of Transmission Service Agreement (TSA)	Annexure-6	56-208



11.	Copy of SLD of the transmission scheme	Annexure-7	309-309
12.	Form-1 for Transmission License with the following enclosures : a) Certificate of Registration, Memorandum of Association and Articles of Association: Enclosure-1 b) Certificate of Bid Evaluation Committee as furnished by BPC: Enclosure-2 c) Copy of Power of Attorney: Enclosure-3	Annexure-8	310-348

Filed by
KHAVDA V-A POWER TRANSMISSION LIMITED
(A 100% wholly owned subsidiary of Power Grid Corporation of India Limited)

Amit Kumar Jain

Represented by **Amit Kumar Jain**
Finance Incharge, **KHAVDA V-A POWER TRANSMISSION LIMITED**

Place: New Delhi
Date : 19/11/2024



**BEFORE THE CENTRAL ELECTRICITY REGULATORY COMMISSION
NEW DELHI**

APPLICATION No :.....

IN THE MATTER OF

Application under Section 14 & 15 of the Electricity Act, 2003 read with Central Electricity Regulatory Commission (Procedure, Terms and Conditions for grant of Transmission License and other related matters) Regulations, 2024 with respect to Transmission License to **KHAVDA V-A POWER TRANSMISSION LIMITED**

KHAVDA V-A POWER TRANSMISSION LIMITED

(A 100% wholly owned subsidiary of Power Grid Corporation of India Limited)

Registered office: B-9, Qutab Institutional Area, Katwaria Sarai, New Delhi 110 016

Address for correspondence: C/o ED (TBCB), Power Grid Corporation of India Limited, Saudamini, Plot no.2, Sector -29, Gurgaon 122001

AND

Chief Operating Officer,
Central Transmission Utility of India Ltd,
Saudamini, Plot no.2, Sector -29,
Gurgaon 122001.....

RESPONDENT(S)

And Others

To
The Secretary
Central Electricity Regulatory Commission
New Delhi

Sir,

The application filed under Section 14 & 15 of the Electricity Act, 2003 read with Central Electricity Regulatory Commission (Procedure, Terms and Conditions for Grant of Transmission License and other related matters) Regulations, 2024 with respect to Transmission License to KHAVDA V-A POWER TRANSMISSION LIMITED, may please be registered.

Applicant

KHAVDA V-A POWER TRANSMISSION LIMITED

(A 100% wholly owned subsidiary of Power Grid Corporation of India Limited)

Represented by Amit Kumar Jain

Finance Incharge, KHAVDA V-A POWER TRANSMISSION
LIMITED

Place: New Delhi

Date: 19/11/2024



**BEFORE THE CENTRAL ELECTRICITY REGULATORY COMMISSION
NEW DELHI**

APPLICATION No :.....

IN THE MATTER OF

Application under Section 14 & 15 of the Electricity Act, 2003 read with Central Electricity Regulatory Commission (Procedure, Terms and Conditions for Grant of Transmission License and other related matters) Regulations, 2024 with respect to Transmission License to KHAVDA V-A POWER TRANSMISSION LIMITED

KHAVDA V-A POWER TRANSMISSION LIMITED

(A 100% wholly owned subsidiary of Power Grid Corporation of India Limited)

Registered office: B-9, Qutab Institutional Area, Katwaria Sarai, New Delhi 110 016

Address for correspondence: C/o ED (TBCB), Power Grid Corporation of India Limited, Saudamini, Plot no.2, Sector -29, Gurgaon 122001

AND

Chief Operating Officer,
Central Transmission Utility of India Ltd,
Saudamini, Plot no.2, Sector -29,
Gurgaon 122001.....

RESPONDENT(S)

And Others

To
The Secretary
Central Electricity Regulatory Commission
New Delhi

MEMO OF PARTIES

KHAVDA V-A POWER TRANSMISSION LIMITED

(A 100% wholly owned subsidiary of Power Grid Corporation of India Limited)

Registered office: B-9, Qutab Institutional Area, Katwaria Sarai, New Delhi 110 016

Address for correspondence: C/o ED (TBCB), Power Grid Corporation of India Limited, Saudamini, Plot no.2, Sector -29, Gurgaon 122001

VERSUS

1.	Chief Operating Officer, Central Transmission Utility of India Ltd, Saudamini, Plot no.2, Sector -29, Gurgaon 122001Respondent
2.	Chief Executive Officer,Respondent



	REC Power Development and Consultancy Limited REC Corporate Head Quarter, D Block, Plot No. I - 4, Sec - 29 Gurugram - 122 001	
3.	General Manager Gujarat Industries Power Company Ltd. PO: Petrochemicals GujaratRespondent
4.	Dy. General Manager Adani Green Energy Ltd., 4th Floor, South Wing, Adani Corporate House, Shantigram, SG Highway, Ahmedabad-382421Respondent
5.	Chhatisgarh State Power Distribution Co. Ltd. CSPDCL, Post: Sundernagar, Dangania, Raipur- 492013Respondent
6.	Goa Electricity Deparement-WR Goa Electricity DeptCurti, Ponda403401Respondent
7.	Gujarat Urja Vikas Nigam Limited Sardar Patel Vidyut Bhavan, Racecourse Vadodara - 390007Respondent
8.	Heavy Water Board O FLOOR, VIKRAM SARABHAI BHAVAN, TROMBAY, ANUSHAKTINAGAR, MUMBAI - 400094 , MaharashtraRespondent
9.	HVDC Bhadrawati, PGCIL PGCIL RHQ, WR-I, Sampriti Nagar, , Off National Highway No. 8, Taluka : Kamrej, PO: Uppalwadi , Nagpur , 440026 MaharashtraRespondent
10.	HVDC Vindhyachal, PGCIL PGCIL RHQ, WR-I, Sampriti Nagar, , Off National Highway No. 8, Taluka : Kamrej, PO: Uppalwadi , Nagpur , 440026 MaharashtraRespondent
11.	M.P. Power Management Company Ltd. 14, Shakti Bhawan, Rampur, Jabalpur - 482008Respondent
12.	MSEDCL Plot No 9, "prakashgad", A K Marg, Bandra East, Mumbai 400051Respondent



[Handwritten signature]

13.	ACB India LIMITED 7th Floor, Corporate Tower, Ambience Mall, NH-8, Gurgaon-122 001(Haryana)Respondent
14.	Torrent Power Limited Torrent Power Ltd. Naranpura Zonal Office, Sola Road, Ahmedabad, 380013Respondent
15.	Thermal Powertech Corporation India 6-3-1090, Clock C, Level 2, TSR , Towers, Rajbhavan Road, Somajiguda , Hyderabad , 500082, TelanganaRespondent
16.	BARC Bhabha Atomic Research Centre, Anushakti Nagar, Mumbai, Maharashtra – 400085Respondent
17.	GMR Warora Energy Limited Plot B-1,GMR Warora Energy Ltd, Mohabala MIDC Growth Centre, Post – Warora, Dist – Chandrapur, Maharashtra, PIN 442907Respondent
18.	HVDC Champa PGCIL RHQ, WR-I, Sampriiti Nagar, , Off National Highway No. 8, Taluka : Kamrej,PO: Uppalwadi , Nagpur , 440026 MaharashtraRespondent
19.	West Central Railway Head Office General Manager's Office,Electrical Branch, Jabalpur– 482 001.Respondent
20.	Western Railway Office Of Chief Electrical EngineerMumbaiRespondent
21.	DB Power Limited- Untied Opp Dena Bank, C-31, G- BlockMumbaiRespondent
22.	Chhattisgarh State Power Trading Co. Ltd. 2nd floor Vidyut Sewa BhawanRaipurRespondent
23.	TRN Energy Private Ltd-Untied 7th Floor, Ambience Office BlockGurugramRespondent
24.	Adani Power (Mundra) Limited. Adani Corporate House, Shantigram, NearRespondent



	Vaishnavdevi Circle, S G Road Ahmedabad - 382421	
25.	Raigarh HVDC Station RPT HVDC Office, Hebbal, Bangalore – 560094Respondent
26.	Arcelor Mittal Nippon Steel India Ltd. 27, AMNS House, 2TH KM Surat Hazira road, Hazira-394270, GujaratRespondent
27.	Central Railway Pcee's office 2nd floor parcle building csmt mumbai-400001Respondent
28.	Dadra and Nagar Haveli and Daman an Power Distribution Corporation Ltd 1st & 2nd Floor, Vidyut Bhavan, NexSilvassa & DamanRespondent
29.	MPSEZ Utilities Ltd. 3rd Floor, Adani Corporate House, SAhmedabadRespondent

[Handwritten Signature]



**BEFORE THE HON'BLE CENTRAL ELECTRICITY REGULATORY
COMMISSION
NEW DELHI**

APPLICATION No :.....

IN THE MATTER OF

Application under Section 14 & 15 of the Electricity Act, 2003 read with Central Electricity Regulatory Commission (Procedure, Terms and Conditions for Grant of Transmission License and other related matters) Regulations, 2024 with respect to Transmission License to KHAVDA V-A POWER TRANSMISSION LIMITED

KHAVDA V-A POWER TRANSMISSION LIMITED

(A 100% wholly owned subsidiary of Power Grid Corporation of India Limited)

Registered office: B-9, Qutab Institutional Area, Katwaria Sarai, New Delhi 110 016

Address for correspondence: C/o ED (TBCB), Power Grid Corporation of India Limited, Saudamini, Plot no.2, Sector -29, Gurgaon 122001

AND

Chief Operating Officer,
Central Transmission Utility of India Ltd,
Saudamini, Plot no.2, Sector -29,
Gurgaon 122001.....

RESPONDENT(S)

And Others

AFFIDAVIT



I, Shri. Amit Kumar Jain, son of Shri Om Prakash Jain residing at A-801, Times Residency, Sector-63, Gurgaon - 122101 do hereby solemnly affirm and state as follows:

1. That the deponent is the Authorised Signatory of Applicant, and is well conversant with the facts and the circumstances of the case and therefore competent to swear this affidavit.
2. That the accompanying Petition under Section 14 & 15 of the Electricity Act, 2003, has been filed by me and the contents of the same are true and correct to the best of my knowledge and belief.

3. That the contents of Para 1 to 23 of the facts as mentioned in the Petition are true and correct based on my personal knowledge, belief and records maintained in the office.
4. That the annexures annexed to the Petition are correct and true copies of the respective originals.
5. That the Deponent has not filed any other Petition or Appeal before any other forum or court of law with respect to the subject matter of the dispute.



Authorised Signatory

KHAVDA V-A POWER TRANSMISSION LIMITED

(A 100% wholly owned subsidiary of Power Grid Corporation of India Limited)

Place: New Delhi

Date: 19/11/24

VERIFICATION:

I, the Deponent above named hereby solemnly hereby affirm that the contents of the above affidavit are true to my knowledge, no part of it is false and nothing material has been concealed therefrom. Verified by me on this the 19th day of Nov..... 2024 at New Delhi.

Deponent

Witness



ATTESTED

**NOTARY PUBLIC
DELHI**

19 NOV 2024

**BEFORE THE CENTRAL ELECTRICITY REGULATORY COMMISSION
NEW DELHI**

Application No.....

IN THE MATTER OF

Application under Section 14 & 15 of the Electricity Act, 2003 read with Central Electricity Regulatory Commission (Procedure, Terms and Conditions for Grant of Transmission License and other related matters) Regulations, 2024 with respect to Transmission License to KHAVDA V-A POWER TRANSMISSION LIMITED

KHAVDA V-A POWER TRANSMISSION LIMITED

(A 100% wholly owned subsidiary of Power Grid Corporation of India Limited)

Registered office: B-9, Qutab Institutional Area, Katwaria Sarai, New Delhi 110 016

Address for correspondence: C/o ED (TBCB), Power Grid Corporation of India Limited, Saudamini, Plot no.2, Sector -29, Gurgaon 122001

AND

Chief Operating Officer,
Central Transmission Utility of India Ltd,
Saudamini, Plot no.2, Sector -29,
Gurgaon 122001.....

RESPONDENT(S)

And Others

Application

The Applicant respectfully submits as under:

1. **KHAVDA V-A POWER TRANSMISSION LIMITED** hereby submits this application under Section 14 & 15 of the Electricity Act, 2003, Central Electricity Regulatory Commission (Procedure, Terms and Conditions for Grant of Transmission License and other related matters) Regulations, 2024 (hereinafter referred to as "Transmission License Regulations") to establish "Transmission System for Evacuation of Power from potential renewable energy zone in Khavda area of Gujarat under Phase-V (8 GW): Part A" on build, own, operate and transfer basis (hereinafter referred to as "the Project") consisting of the following elements:



S. No.	Name of the Transmission Element	Scheduled COD in months from Effective Date	Percentage of Quoted Transmission Charges recoverable on Scheduled COD of the Element of the Project	Element(s) which are pre-required for declaring the commercial operation (COD) of the respective Element
1A. #	Establishment of 3000 MW, ± 800 kV KPS2 (HVDC) [LCC] terminal station (2x1500 MW) (Bipole-1) along with associated interconnections with 400 kV HVAC Switchyard*.	48 months for Bipole1 (2x1500 MW) and all other elements [mentioned at Sl. 1A, 2A, 3, 4, 5 & 6] and 54 months for Bipole 2 (2x1500 MW) [mentioned at Sl. 1B & 2B] (from date of SPV transfer.)	31.03%	All Elements (except Bipole 2 (2x1500MW)) are required to be commissioned simultaneously in 48 months as their utilization is dependent on commissioning of each other. The Bipole2 (2x1500MW) shall be commissioned in 54 months.
2A. #	Establishment of 3000 MW, ± 800 kV Nagpur (HVDC) [LCC] terminal station (2x1500 MW) (Bipole-1) along with associated interconnections with 400 kV HVAC Switchyard*			
1B. #	Establishment of 3000 MW, ± 800 kV KPS2 (HVDC) [LCC] terminal station (2x1500 MW) (Bipole-2) along with associated interconnections with 400 kV HVAC Switchyard*.		31.03%	
2B. #	Establishment of 3000 MW, ± 800 kV Nagpur (HVDC) [LCC] terminal station (2x1500 MW) (Bipole-2) along with associated interconnections with 400 kV HVAC Switchyard*			
3.	±800 kV HVDC Bipole line (Hexa lapwing) between KPS2 (HVDC) and Nagpur (HVDC) (1200 km) (with Dedicated Metallic Return) (capable to evacuate 6000 MW with overload as specified)		37.94%	
4.	Establishment of 6x1500 MVA, 765/400 kV ICTs at Nagpur S/s along with 2x330 MVAR (765 kV) & 2x125 MVAR, 420 kV bus reactors along with associated interconnections with HVDC Switchyard*. The 400 kV bus shall be established in 2 sections through 1 set of 400 kV bus sectionaliser so that 3x1500 MVA ICTs are placed in each section. The bus sectionaliser shall be normally closed and may be opened based on Grid requirement. <ul style="list-style-type: none"> • 765/400 kV, 1500 MVA ICT-6 (3 on each 400 kV section) (19 single phase units including one spare unit) • 765 kV ICT bays- 6 Nos. 			



Agarwal

	<ul style="list-style-type: none"> • 400 kV ICT bays- 6 Nos. (3 on each section) • 330 MVAR 765 kV bus reactor-2 Nos. • 125 MVAR 420 kV bus reactor-2 Nos. (one on each section) • 765 kV reactor bay- 2 Nos. • 765 kV line bay- 4 Nos. • 400 kV reactor bay- 2 Nos. (one on each section) • 400 kV Bus sectionaliser - 1 Set • 110 MVAR, 765 kV, 1-ph reactor (spare unit for line/bus reactor) - 1 No. <p>Future Provisions at Nagpur: Space for:</p> <ul style="list-style-type: none"> • 765/400 kV, 1500 MVA ICT- 4 (1 on 400 kV bus section-II & 3 on future 400 kV bus section-III) • 765 kV line bays along with switchable line reactors – 10 Nos. • 765 kV Bus Reactor along with bay: 2 No. • 765 kV Sectionalizer bay: 1 -set • 400 kV line bays along with switchable line reactor – 12 Nos. • 400 kV Bus sectionaliser- 1 Set • 400/220 kV ICT along with bays -9 Nos. (3 Nos. on 400 kV bus sections II & 6 Nos. on future bus section-III) • 400 kV Bus Reactor along with bay: 4 No. (1 each on 400 kV bus sections I & II and 2 on future 400 kV bus section-III) • 220 kV line bays: 16 Nos. • 220 kV Sectionalization bay: 2 set • 220 kV BC & TBC: 3 Nos. • 80 MVAR, 765 kV, 1-ph reactor (spare unit for line reactor)-1 			
5.	LILO of Wardha – Raipur 765 kV one D/c line (out of 2xD/c lines) at Nagpur			
6.	<p>Installation of 240 MVAR switchable line reactor at Nagpur end on each ckt of Nagpur – Raipur 765 kV D/c line</p> <ul style="list-style-type: none"> • 240 MVAR, 765 kV switchable line reactors- 2 Nos. (at Nagpur end) • Switching equipment for 765 kV line reactor- 2 Nos. (at Nagpur end) • 80 MVAR, 765 kV, 1-ph reactor (spare unit for line reactor)-1 No. 			

* The 400 kV interconnections (along with all associated equipment/ bus extension, etc.) between HVDC & HVAC switchyards shall be implemented by the TSP.



Scope w.r.t. 6000 MW, \pm 800 kV HVDC [LCC] terminal station (4x1500 MW) at KPS2 & Nagpur has been split into 3000 MW, \pm 800 kV HVDC [LCC] terminal station (2x1500 MW) Bipole-1 (Sl. 1A & 2A) and 3000 MW, \pm 800 kV HVDC [LCC] terminal station (2x1500 MW) Bipole-2 (Sl. 1B & 2B) for sake of calculation of Percentage of Quoted Transmission Charges.

Note:

- i. The 2x1500 MW poles shall emanate from 400 kV bus section 1 of KPS2 and terminate at bus section 1 of Nagpur. Similarly, the other 2x1500 MW poles shall emanate from 400 kV bus section 2 of KPS2 and terminate at bus section 2 of Nagpur.
 - ii. HVDC System will be designed considering 100% power reversal capability. The rated power transmission capacity as well as the rated transmission voltage shall be defined and guaranteed at the rectifier end of the AC yard.
 - iii. TSP of KPS2 shall provide space for the establishment of the HVDC system as per above scope.
 - iv. The implementation timeframe: 48 months for Bipole-1 (2x1500 MW) and all other elements except Bipole 2 (2x1500MW) and 54 months for Bipole-2 (2x1500 MW) (from date of SPV acquisition).
2. Ministry of Power, Government of India, vide Gazette notification no. 3733 No. 15/3/2018-Trans-Pt(1) dated 04.09.2023 has notified REC Power Development and Consultancy Limited (RECPDCL) as the Bid Process Coordinator (hereinafter referred to as BPC) for the purpose of selection of Bidder as Transmission Service Provider (TSP) to establish Transmission System for Evacuation of Power from potential renewable energy zone in Khavda area of Gujarat under Phase-V (8 GW): Part A (hereinafter referred to as "the Project") through Tariff Based Competitive Bidding process on build, own, operate and transfer basis. A copy of the notification is enclosed and marked as Annexure-1, (Page ..19.... to Page ...21.....).
 3. That a company under the Companies Act 2013 by the name "**KHAVDA V-A POWER TRANSMISSION LIMITED**" having its registered office at New Delhi has been incorporated on 10.10.2023 by RECPDCL as its wholly owned subsidiary to initiate the activities for execution of the Project and subsequently to act as Transmission Service Provider (TSP) after being acquired by the successful bidder selected through Tariff Based Competitive Bidding process.
 4. BPC has initiated the selection of successful bidder to acquire the TSP in accordance with the "Tariff Based Competitive Bidding Guidelines for Transmission Service" and "Guidelines for Encouraging Competition in Development of Transmission Projects" issued by Government of India, Ministry of Power under section – 63 of The Electricity Act, 2003 and as amended from time to time.
 5. That in the RFP documents, the following is stated



[Handwritten signature]

Quote

“The Transmission Charges shall be payable by the Designated ISTS Customers in Indian Rupees through the CTU as per Central Electricity Regulatory Commission (Sharing of Inter-State Transmission Charges and Losses) Regulations as amended from time to time..”

Unquote

Copy of the relevant extract of the RFP document issued by the BPC is enclosed and marked as **Annexure-2**, (Page ..~~22~~... to Page ..~~23~~....) which are integral part of the RFP bidding documents furnished by BPC for bidding..

6. Subsequent to the process of competitive bidding conducted by the BPC, Power Grid Corporation of India Limited has been declared as the successful bidder. The Letter of Intent was issued to Power Grid Corporation of India Limited on 24.10.2024. A copy of the Letter of Intent (LoI) alongwith the details of Annual Transmission Charges is enclosed and marked as **Annexure-3**, (Page ..~~24~~.... to Page ..~~31~~....).
7. As per the provisions 2.15.2 of Request for Proposal (RFP) and the Letter of Intent issued to Power Grid Corporation of India Limited, within 10 days of issuance of Letter of Intent by the BPC, the Successful Bidder is required to inter-alia provide the Contract Performance Guarantee, execute Share Purchase Agreement & the Transmission Service Agreement and acquire the SPV. Vide letters dated 19.11.2024, the BPC in terms of provisio Clause 2.15.2 of RFP has extended the date upto 26.11.2024 for completion of activities by the successful bidder. A copy of the relevant extract of the RFP and the letter from BPC is enclosed and marked as **Annexure-4**, (Page~~32~~... to Page~~35~~....).
8. That in accordance with the LoI, Power Grid Corporation of India Limited on 19.11.2024 has furnished a Contract Performance Guarantee of Rs. 714.00 Crore (Rupees Seven Hundred Fourteen Crore Only) in favour of Central Transmission Utility of India Limited (CTUIL).

Power Grid Corporation of India Limited has acquired the **KHAVDA V-A POWER TRANSMISSION LIMITED** on 19.11.2024, after execution of the Share Purchase Agreement, and completing all procedural requirements specified in the RFP documents. A copy of the Share purchase agreement is enclosed and marked as **Annexure – 5**, (Page ..~~36~~.... to Page ..~~55~~....).
9. A copy of the Transmission Service Agreement (TSA) entered between CTUIL and “**KHAVDA V-A POWER TRANSMISSION LIMITED**” is enclosed and marked as **Annexure-6**, (Page ..~~56~~... to Page~~308~~....).
10. The Applicant shall map Nodal Agency i.e. CTUIL on the e-portal of this Hon’ble Commission at the earliest as per the procedure in vogue and completion of relevant formalities. The Applicant is also sending a copy of the present Petition to CTUIL via e-mail in accordance with the requirement under section 15 (3) of the Electricity Act, 2003 and regulation 5 (3) of Transmission License Regulations, 2024 for its recommendation under section 15 (4) of the Electricity Act, 2003 and regulation 5 (9) of Transmission License Regulations, 2024.



[Handwritten signature]

11. That a copy of the Application has also been marked to BPC to enable submission of the requisite documents / information by BPC before this Hon'ble Commission regarding the Bidding process undertaken and thereby ensure processing of application.
12. That a copy of the Application has also been marked to Designated ISTS Customers (DICs) and beneficiaries of the Western Region as party to the Petition based on the list of the DICs and beneficiaries furnished by the CTUIL.
13. The application along with Form-I is being hosted on the website and is accessible on www.powergrid.in/subsidiaries in compliance with Regulation 5 (4) of Transmission License Regulations, 2024. It is undertaken that notice of the Application as per Form-II of Transmission License Regulations shall be posted on the e-filing portal of the Commission and also on the Applicant's website in compliance with Regulation 5 (4) of Transmission License Regulations, 2024. Further, in compliance with regulation 5(5) Transmission License Regulations, 2024, the notice of the Application as per Form-II of Transmission License Regulations shall be published in atleast two leading daily digital newspaper, one in English and another in Gujarati & Marathi i.e., Indian languages of the Indian states Viz., Gujarat and Maharashtra ,where the elements of the project are situated for inviting comments from general public. The notice shall also be kept posted on the website of the applicant..
14. It is further undertaken that the petitioner in accordance with Regulation 5(8) of Transmission License Regulations, 2024 shall submit to the commission in affidavit the details of the notice published, names of the digital newspapers in which the notice has been published, the dates and places of their publication and enclosing the relevant pages of the publication of the notice.
15. That a copy of SLD of the transmission scheme is enclosed and marked as **Annexure -7** (Page ...~~307~~... to Page ...~~307~~...).
16. That POWERGRID has acquired the TSP on 19.11.2024 and the same is effective date of the project as per provisions of TSA. The schedule construction period of the project is 54 months. As such Scheduled CoD of the project works out to be 19.05.2029.
17. The applicant is hereby fulfilling the obligations as per 2.15.4 of the RFP documents and all the procedures as stipulated in the CERC (Procedure, Terms and Conditions for grant of Transmission License and other related matters) Regulations, 2024 for grant of Transmission license.
18. Section 14 of the Electricity Act, 2003 (the Act) provides that the Appropriate Commission may, on an application made under section 15 of the Electricity Act, 2003, grant License to any person to transmit electricity as a transmission licensee in any area as may be specified in the License. The word 'person' has been defined in section 2 (49) of the Act to include any company or body corporate or association or body of individuals, whether incorporated or not, or artificial juridical person.

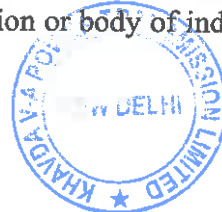

[Handwritten signature]

19. Section 15(1) of the Act provides that every application under section 14 shall be made in such manner and in such form as may be specified by the Appropriate Commission and shall be accompanied such fees as may be prescribed. Central Electricity Regulatory Commission has notified Transmission License Regulations (Procedure, Terms and Conditions for Grant of Transmission License and other related matters) and as per Regulation 4 of the aforementioned Regulations, a person selected through the process under the guidelines for competitive bidding is eligible for grant of license.
20. That the applicant - **KHAVDA V-A POWER TRANSMISSION LIMITED** incorporated under the Companies Act, 2013 is a 100% wholly owned subsidiary of Power Grid Corporation of India Limited who has been selected on the basis of the Tariff Based Competitive Bidding as per the Tariff Based Competitive Bidding Guidelines for Transmission Service issued by Govt. of India, Ministry of Power and thus eligible for issuance of transmission license.
21. Duly filled Form 1 for Transmission License in English, Gujarati and Marathi in accordance with the Transmission License Regulations, 2024 is enclosed herewith and marked as **Annexure-8, (Page ...310... to Page ...348...)**. The notice of the application as per Form-I of Transmission License Regulations, 2024 in English, Gujarati and Marathi shall be posted on the e-filing portal of the Commission and on the Applicant's website in compliance with Regulation 5 (4) of Transmission License Regulations, 2024
22. That the Transmission Project under reference is governed by the TSA dated 19.11.2024 signed between CTUIL and the Applicant. All the terms of TSA are binding on the signatories of the agreement.

That the Applicant would implement the Project as per the provisions of the TSA including the Articles 16.4 (Parties to Perform Obligations), 5.1.1 (TSP's Construction Responsibilities) and 5.4 (Quality of Workmanship).

Further the time over run and cost overrun, if applicable, shall be claimed by the Applicant in accordance with the applicable provisions of the TSA read with the provisions of the Electricity Act 2003, the bidding documents, the regulations of the Central Electricity Regulatory Commission and the exercise of power by Central Electricity Regulatory Commission under the Act and the Regulation.

23. It is submitted that Section 14 of the Electricity Act, 2003 empowers the Appropriate Commission to grant License.

24. PRAYER

It is respectfully prayed that the Hon'ble Commission may be pleased to:

- a) Grant Transmission License to the Applicant ; and



[Handwritten signature]

- b) Allow the sharing and recovery of Transmission Charges for Inter-State Transmission System for "Transmission System for Evacuation of Power from potential renewable energy zone in Khavda area of Gujarat under Phase-V (8 GW): Part A" as per Sharing of Inter-state Transmission Charges and Losses CERC Regulations 2020 and any other amendment thereon issued from time to time by CERC.
- c) Pass such other order / orders, as may be deemed fit and proper in the facts & circumstances of the case

KHAVDA V-A POWER TRANSMISSION LIMITED

Applicant

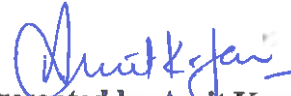

Represented by Amit Kumar Jain

**Finance Incharge, KHAVDA V-A POWER TRANSMISSION
LIMITED**

Place: New Delhi

Date: 19/11/24



MINISTRY OF POWER

NOTIFICATION

New Delhi, the 29th August, 2023

S.O. 3894(E).—In exercise of the powers conferred by sub-para 3.2 of Para 3 of the Guidelines circulated under Section 63 of the Electricity Act, 2003 (no. 36 of 2003), the Central Government, on recommendations of 14th meeting of National Committee on Transmission, hereby appoints the following Bid-Process Coordinators (BPCs) for the Transmission Schemes, as shown against the name of the Transmission Schemes: -

Sl. No.	Name & Scope of the Transmission Scheme	Bid Process Coordinator															
1.	<p>Transmission System for Evacuation of Power from potential renewable energy zone in Khavda area of Gujarat under Phase-IV (7 GW): Part A</p> <p>Tentative Implementation timeframe: 24 months from SPV transfer and matching with Parts B, C & D of Khavda Ph-IV (7 GW)</p> <p>Scope:</p> <table border="1"> <thead> <tr> <th>Sl. No.</th> <th>Scope of the Transmission Scheme</th> <th>Capacity/ Route length</th> </tr> </thead> <tbody> <tr> <td>1.</td> <td> <p>Creation of 765 kV bus section-II at KPS3 (GIS) along with 765 kV Bus Sectionaliser & 1x330 MVAR, 765 kV Bus Reactors on Bus Section-II</p> <p>Bus section – II shall be created at 765 kV & 400 kV level both with 3x1500 MVA, 765/400 kV ICTs at Bus Section-II</p> </td> <td> <p>Bus Section-II at KPS3</p> <p>765 kV Bus Sectionaliser – 1 set</p> <p>1500 MVA, 765/400 kV ICT – 3 Nos.</p> <p>330 MVAR, 765 kV Bus Reactor – 1 No.</p> <p>765 kV reactor bay – 1 No.</p> <p>765 kV ICT bays – 3 Nos.</p> </td> </tr> <tr> <td>2.</td> <td> <p>Creation of 400 kV bus Section-II at KPS3 (GIS) along with 400 kV Bus Sectionaliser & 1x125 MVAR, 420 kV Bus Reactors on Bus Section-II and 3 Nos. 400 kV bays at Bus Section-II for RE interconnection</p> </td> <td> <p>Bus Section-II at KPS3</p> <p>400 kV Bus Sectionaliser – 1 set</p> <p>125 MVAR, 420 kV Bus Reactors – 1 No.</p> <p>400 kV reactor bay – 1 No.</p> <p>400 kV ICT bays – 3 Nos. (for ICTs at Sl. 1 above)</p> <p>400 kV line bays – 3 Nos. (for RE interconnection)</p> </td> </tr> <tr> <td>3.</td> <td>KPS3 (GIS) – Lakadia (AIS) 765 kV D/C line</td> <td>Route length: 185 km</td> </tr> <tr> <td>4.</td> <td>2 Nos. of 765 kV line bays each at KPS3 (GIS) & Lakadia (AIS) for KPS3 (GIS) – Lakadia (AIS) 765 kV D/C line</td> <td> <ul style="list-style-type: none"> 765 kV line bays (GIS) – 2 Nos. (at KPS3 end Bus section-II) </td> </tr> </tbody> </table>	Sl. No.	Scope of the Transmission Scheme	Capacity/ Route length	1.	<p>Creation of 765 kV bus section-II at KPS3 (GIS) along with 765 kV Bus Sectionaliser & 1x330 MVAR, 765 kV Bus Reactors on Bus Section-II</p> <p>Bus section – II shall be created at 765 kV & 400 kV level both with 3x1500 MVA, 765/400 kV ICTs at Bus Section-II</p>	<p>Bus Section-II at KPS3</p> <p>765 kV Bus Sectionaliser – 1 set</p> <p>1500 MVA, 765/400 kV ICT – 3 Nos.</p> <p>330 MVAR, 765 kV Bus Reactor – 1 No.</p> <p>765 kV reactor bay – 1 No.</p> <p>765 kV ICT bays – 3 Nos.</p>	2.	<p>Creation of 400 kV bus Section-II at KPS3 (GIS) along with 400 kV Bus Sectionaliser & 1x125 MVAR, 420 kV Bus Reactors on Bus Section-II and 3 Nos. 400 kV bays at Bus Section-II for RE interconnection</p>	<p>Bus Section-II at KPS3</p> <p>400 kV Bus Sectionaliser – 1 set</p> <p>125 MVAR, 420 kV Bus Reactors – 1 No.</p> <p>400 kV reactor bay – 1 No.</p> <p>400 kV ICT bays – 3 Nos. (for ICTs at Sl. 1 above)</p> <p>400 kV line bays – 3 Nos. (for RE interconnection)</p>	3.	KPS3 (GIS) – Lakadia (AIS) 765 kV D/C line	Route length: 185 km	4.	2 Nos. of 765 kV line bays each at KPS3 (GIS) & Lakadia (AIS) for KPS3 (GIS) – Lakadia (AIS) 765 kV D/C line	<ul style="list-style-type: none"> 765 kV line bays (GIS) – 2 Nos. (at KPS3 end Bus section-II) 	REC Power Development and Consultancy Limited
Sl. No.	Scope of the Transmission Scheme	Capacity/ Route length															
1.	<p>Creation of 765 kV bus section-II at KPS3 (GIS) along with 765 kV Bus Sectionaliser & 1x330 MVAR, 765 kV Bus Reactors on Bus Section-II</p> <p>Bus section – II shall be created at 765 kV & 400 kV level both with 3x1500 MVA, 765/400 kV ICTs at Bus Section-II</p>	<p>Bus Section-II at KPS3</p> <p>765 kV Bus Sectionaliser – 1 set</p> <p>1500 MVA, 765/400 kV ICT – 3 Nos.</p> <p>330 MVAR, 765 kV Bus Reactor – 1 No.</p> <p>765 kV reactor bay – 1 No.</p> <p>765 kV ICT bays – 3 Nos.</p>															
2.	<p>Creation of 400 kV bus Section-II at KPS3 (GIS) along with 400 kV Bus Sectionaliser & 1x125 MVAR, 420 kV Bus Reactors on Bus Section-II and 3 Nos. 400 kV bays at Bus Section-II for RE interconnection</p>	<p>Bus Section-II at KPS3</p> <p>400 kV Bus Sectionaliser – 1 set</p> <p>125 MVAR, 420 kV Bus Reactors – 1 No.</p> <p>400 kV reactor bay – 1 No.</p> <p>400 kV ICT bays – 3 Nos. (for ICTs at Sl. 1 above)</p> <p>400 kV line bays – 3 Nos. (for RE interconnection)</p>															
3.	KPS3 (GIS) – Lakadia (AIS) 765 kV D/C line	Route length: 185 km															
4.	2 Nos. of 765 kV line bays each at KPS3 (GIS) & Lakadia (AIS) for KPS3 (GIS) – Lakadia (AIS) 765 kV D/C line	<ul style="list-style-type: none"> 765 kV line bays (GIS) – 2 Nos. (at KPS3 end Bus section-II) 															



Attested from Pg 19 - Pg 21

ATTESTED TRUE COPY

[Signature]
 Authorised Signatory
 KHAVDA V.A. POWER TRANSMISSION LIMITED

Sl. No.	Scope of the Transmission Scheme	Capacity
1.	Establishment of 6000 MW, \pm 800 kV KPS2 (HVDC) [LCC] terminal station (4x1500 MW) along with associated interconnections with 400 kV HVAC Switchyard*.	6000 MW, \pm 800 kV KPS2 (HVDC) [LCC] Terminal station
2.	Establishment of 6000 MW, \pm 800 kV Nagpur (HVDC) [LCC] terminal station (4x1500 MW) along with associated interconnections with 400 kV HVAC Switchyard*	6000 MW, \pm 800 kV Nagpur (HVDC) [LCC] terminal station
3.	\pm 800 kV HVDC Bipole line (Hexaplapwing) between KPS2 (HVDC) and Nagpur (HVDC) (1200 km) (with Dedicated Metallic Return) (capable to evacuate 6000 MW with overload as specified)	Route length: 1200 km.
4.	Establishment of 6x1500 MVA, 765/400 kV ICTs at NagpurS/s along with 2x330 MVAR (765 kV) & 2x125 MVAR, 420 kV bus reactors along with associated interconnections with HVDC Switchyard*. The 400 kV bus shall be established in 2 sections through 1 set of 400 kV bus sectionaliser so that 3x1500 MVA ICTs are placed in each section. The bus sectionaliser shall be normally closed and may be opened based on Grid requirement. Future Provisions at Nagpur: Space for:	<ul style="list-style-type: none"> ○ ○ 765/400 kV, 1500 MVA ICT-6 (3 on each 400 kV section) (19 single phase units including one spare unit) ○ 765 kV ICT bays- 6 Nos. ○ 400 kV ICT bays- 6 Nos. (3 on each section) ○ 330 MVAR 765 kV bus reactor-2 Nos. ○ 125 MVAR 420 kV bus reactor-2 Nos. (one on each section) ○ 765 kV reactor bay- 2 Nos. ○ 765 kV line bay- 4 Nos. ○ 400 kV reactor bay- 2 Nos. (one on each section) ○ 400 kV Bus sectionaliser - 1 Set ○ 110 MVAR, 765 kV, 1-ph reactor (spare unit for line/bus

REC Power Development and Consultancy Limited



	<ul style="list-style-type: none"> reactor – 12 Nos. ○ 400 kV Bus sectionaliser- 1 Set ○ 400/220 kV ICT along with bays -9 Nos. (3 Nos. on 400 kV bus sections II & 6 Nos. on future bus section-III) ○ 400 kV Bus Reactor along with bay: 4 No. (1 each on 400 kV bus sections I & II and 2 on future 400 kV bus section-III) ○ 220 kV line bays: 16 Nos. ○ 220 kV Sectionalization bay: 2 set ○ 220 kV BC & TBC: 3 Nos. ○ 80 MVAR, 765 kV, 1-ph reactor (spare unit for line reactor)-1 	reactor) - 1 No.
5.	LILO of Wardha – Raipur 765 kV one D/c line (out of 2xD/c lines) at Nagpur	LILO route length: 30 km.
6.	Installation of 240 MVAR switchable line reactor at Nagpur end on each ckt of Nagpur – Raipur 765 kV D/c line	<ul style="list-style-type: none"> • 240 MVAR, 765 kV switchable line reactors- 2 Nos. (at Nagpur end) • Switching equipment for 765 kV line reactor- 2 Nos. (at Nagpur end) • 80 MVAR, 765 kV, 1-ph reactor (spare unit for line reactor)-1 No.
<p>* The 400 kV interconnections (along with all associated equipment/ bus extension, etc.) between HVDC & HVAC switchyards shall be implemented by the TSP</p> <p>Note:</p> <ol style="list-style-type: none"> i. The 2x1500 MW poles shall emanate from 400 kV bus section 1 of KPS2 and terminate at bus section 1 of Nagpur. Similarly, the other 2x1500 MW poles shall emanate from 400 kV bus section 2 of KPS2 and terminate at bus section 2 of Nagpur. ii. HVDC System will be designed considering 100% power reversal capability. The rated power transmission capacity as well as the rated transmission voltage shall be defined and guaranteed at the rectifier end of the AC yard. iii. TSP of KPS2 shall provide space for the establishment of the HVDC system as per above scope. iv. The line lengths mentioned above are approximate as the exact length shall be obtained after the detailed survey. v. The implementation timeline mentioned above is tentative. Final Timeline would be indicated in the RfP Document. 		



**STANDARD SINGLE STAGE REQUEST FOR PROPOSAL
DOCUMENT**

FOR

**SELECTION OF BIDDER AS TRANSMISSION SERVICE
PROVIDER THROUGH TARIFF BASED COMPETITIVE
BIDDING PROCESS**

TO

ESTABLISH INTER-STATE TRANSMISSION SYSTEM

FOR

**TRANSMISSION SYSTEM FOR EVACUATION OF POWER
FROM POTENTIAL RENEWABLE ENERGY
ZONE IN KHAVDA AREA OF GUJARAT UNDER PHASE-V (8
GW): PART A**

ISSUED BY

**REC Power Development and Consultancy Limited
(A wholly owned subsidiary of REC Limited)**

**Registered Office:
Core-4, SCOPE Complex,
7, Lodhi Road, New Delhi – 110 003
Email: pshariharan@recpdcl.in & tbc@recpdcl.in**

04.12.2023

ATTESTED TRUE COPY
Attested from Pg 22 - Pg 23

Authorized Signatory

REC Power Development and Consultancy Limited

KHAVDA V-A POWER TRANSMISSION LIMITED



The entire bidding process shall be conducted on electronic platform created by MSTC Limited.

The Bid shall be a single stage two envelope bid comprising the Technical Bid and the Financial Bid. The Bidders shall submit the Bid online through the electronic bidding platform. In addition to the online submission, the Bidder with lowest Final Offer will be required to submit original hard copies of Annexure 3, Annexure 4 (if applicable), Annexure 6 (if applicable) and Annexure 14 before issuance of LoI. There shall be no physical submission of the Financial Bid.

The Technical Bid shall be opened first and the Financial Bid of only the bidder who have qualified in the Technical Bid shall be opened. The Financial Bid will comprise of two rounds. In the first round the Initial Offer of the responsive bids would be opened and Quoted Transmission Charges of Initial Offer shall be ranked on the basis of ascending order. The Bidders, in the first fifty per cent of the ranking (with any fraction rounded off to higher integer) or four Bidders, whichever is higher, shall qualify for participating in the electronic reverse auction stage and submit their Final Offer.

6. The objective of the bidding process is to select a Successful Bidder pursuant to this RFP, who shall acquire one hundred percent (100%) of the equity shares of Khavda V A Power Transmission Limited along with all its related assets and liabilities as per the provisions of the Share Purchase Agreement, at the Acquisition Price to be intimated by the BPC, twenty (20) days prior to the Bid Deadline.

The Khavda V A Power Transmission Limited, of which one hundred percent (100%) equity shares will be acquired by the Selected Bidder, shall be responsible as the TSP, for ensuring that it undertakes ownership, financing, development, design, engineering, procurement, construction, commissioning, operation and maintenance of the Project, and to provide Transmission Service as per the terms of the RFP Project Documents.

The TSP shall ensure transfer of all project assets along with substation land, right of way and clearances to CTU or its successors or an agency as decided by the Central Government after 35 years from COD of project at zero cost and free from any encumbrance and liability. The transfer shall be completed within 90 days after 35 years from COD of project failing which CTU shall be entitled to take over the project assets Suo moto.

7. **Commencement of Transmission Service:** The Bidder shall have to commence Transmission Service in accordance with the provisions of the Transmission Service Agreement.
8. **Transmission Charges:** The Transmission Charges shall be payable by the Designated ISTS Customers in Indian Rupees through the CTU as per Central Electricity Regulatory Commission (Sharing of Inter-State Transmission Charges and Losses) Regulations as amended from time to time. Bidders shall quote the Transmission Charges as per the pre-specified structure, as mentioned in the RFP.
9. **Issue of RFP document:** The detailed terms and conditions for qualification and selection of the Transmission Service Provider for the Project and for submission of Bid are indicated in the RFP document. All those interested in purchasing the RFP document may respond in writing to Chief Executive Officer, pshariharan@recpdcl.in & tbc@recpdcl.in at the address given in para 12 below with a non-refundable fee of Rs. 5,00,000/- (Rupees Five Lakh Only) or US\$ 7,000 (US Dollars Seven Thousand Only) plus GST @18%, to be paid latest by 05.02.2024 via electronic transfer to the following Bank Account:





Ref No.: RECPDCL/TBCB/Khavda Ph-V Part A/2024-25/2502

Date: 24.10.2024

Sh. Pankaj Pandey,
Executive Director
Power Grid Corporation of India Limited
'Saudamini', Plot no. 2, Sector - 29,
Gurugram - 122001 (Haryana)

"Transmission System for Evacuation of Power from Potential Renewable Energy
Zone in Khavda area of Gujarat under Phase-V (8 GW): Part A" through Tariff Based
Competitive Bidding Process (TBCB) - Letter of Intent

Dear Sir,

We refer to:

1. The Request for Proposal (RfP) dated 04.12.2023 comprising RfP, Draft Transmission Service Agreement, Share Purchase Agreement and Survey Report dated 25.01.2024 issued to M/s Power Grid Corporation of India Limited, as regards participation in the Global Invitation for Bids for establishment of "Transmission System for Evacuation of power from potential renewable energy zone in Khavda area of Gujarat under Phase-V (8 GW): Part A" through Tariff Based Competitive Bidding process including all correspondence/clarifications/amendments/errata/corrigendum issued by REC Power Development and Consultancy Limited in regard thereto (hereinafter collectively referred to as the 'Final RFP') till the submission of Bid Deadline and as listed below:

- (i) Amendment-I dated 16.01.2024,
- (ii) Amendment-II dated 05.02.2024,
- (iii) Amendment-III dated 04.03.2024,
- (iv) Amendment-IV and Clarifications dated 12.03.2024,
- (v) Amendment-V and Additional Clarifications dated 22.03.2024,
- (vi) Amendment-VI dated 04.04.2024,
- (vii) Amendment-VII dated 19.04.2024,
- (viii) Amendment-VIII dated 02.05.2024,
- (ix) Amendment-IX and dated Additional Clarifications 03.05.2024,
- (x) Amendment-X dated 06.05.2024,
- (xi) Amendment-XI dated 09.05.2024,
- (xii) Amendment-XII and Additional Clarifications dated 15.05.2024,
- (xiii) Amendment-XIII dated 19.05.2024,
- (xiv) Amendment-XIV dated 23.05.2024,
- (xv) Amendment-XV dated 31.05.2024,
- (xvi) Amendment-XVI dated 06.06.2024,
- (xvii) Amendment-XVII dated 15.06.2024,
- (xviii) Amendment-XVIII dated 24.06.2024,
- (xix) Amendment-XIX dated 05.07.2024,
- (xx) Amendment-XX dated 11.07.2024,
- (xxi) Amendment-XXI dated 20.07.2024,
- (xxii) Amendment-XXII dated 31.07.2024,
- (xxiii) Amendment-XXIII dated 07.08.2024,
- (xxiv) Amendment-XXIV dated 21.08.2024,



Attested from Pg 24 - Pg 31
ATTESTED TRUE COPY

[Signature]
Authorized Signatory
KHA V A P O W E R T R A N S M I S S I O N L I M I T E D



(xxv) Amendment-XXV dated 30.08.2024.

(xxvi) Amendment-XXVI and Additional Clarifications dated 30.08.2024,

2. The offer of M/s Power Grid Corporation of India Limited by way of a Technical Bid pursuant to (1) above submitted on 06.09.2024 in response to the Final RFP.
3. The Initial Price Offer of M/s Power Grid Corporation of India Limited as submitted on 06.09.2024 in response to the Final RFP.
4. The final offer of M/s Power Grid Corporation of India Limited, discovered during e-Reverse Auction, conducted on 20.09.2024 in response to the Final RFP.
5. The Technical Bid as in (2) above, the Initial Price Offer as in (3) above and the Final Offer as in (4) above hereinafter collectively referred to as the 'Bid'.

We are pleased to inform you that your proposal and offer received by way of the 'Bid' has been accepted and M/s Power Grid Corporation of India Limited is hereby declared as Successful Bidder as per clause 3.6.1 of the Final RFP for the above project and consequently, this Letter of Intent (hereinafter referred to as the 'Lol') is being issued in 2 copies. One original plus One copy.

This Lol is based on the Final RFP and is further contingent upon you satisfying the following conditions:

- (a) Acknowledging its issuance and unconditionally accepting its contents and recording 'Accepted unconditionally' under the signature and stamp of your authorized signatory on each page of the duplicate copy of this letter attached herewith and returning the same to REC Power Development and Consultancy Limited within 7 (Seven) days from the date of issuance of Lol.
- (b) Completion of various activities as stipulated in the RFP including in particular Clause 2.15.2, Clause 2.15.3 and Clause 2.15.4 of the Final RFP within the timelines as prescribed therein.
- (c) Provide the Contract Performance Guarantee of Rs. 714.00 Crore (Rupees Seven Hundred Fourteen Crore Only) within 10 (Ten) days from issue of this Lol, in favour of the Central Transmission Utility of India Limited, as per the provisions of Clause 2.12.

It may be noted that REC Power Development and Consultancy Limited has the rights available to them under the Final RFP, including rights under clause 2.15.5 and 3.6.3 thereof, upon your failure to comply with the aforementioned conditions.

As you are aware, the issuance and contents of this Lol are based on the Bid submitted by you as per the Final RFP including the Transmission Charges and other details regarding the Scheduled COD as contained therein. The Quoted Transmission Charges as submitted by you and the Scheduled COD of transmission elements as agreed by you in your Bid, as per Annexure 21 and Format-1 of Annexure-8 respectively of the Final RFP is enclosed herewith as Schedule-A and incorporated herein by way of reference.



Further, please note that relationship of M/s Power Grid Corporation of India Limited with the REC Power Development and Consultancy Limited & Central Transmission Utility of India Limited will be governed solely on the basis of the Final RFP.

You are requested to unconditionally accept the Lol, and record on one copy of the Lol, 'Accepted unconditionally', under the signature of the authorized signatory of your Company and return such copy to us within 7 (Seven) days of issue of Lol.

With kind regards,



Yours faithfully

[Signature]
(t.s.c. bosh) 22/10/2024

Chief Executive Officer

Enclosures:

1. Schedule A: Quoted Transmission Charges and the scheduled COD of transmission element submitted in your Bid, as per Annexure 21 and Format-1 of Annexure-8 respectively of the Final RFP.

Copy for kind information to:

1. **The Secretary,**
Central Electricity Regulatory Commission,
6th Floor, Tower B, World Trade Centre,
Nauroji Nagar, New Delhi-110029.
2. **The Chairperson,**
Central Electricity Authority,
Sewa Bhawan, R K Puram,
New Delhi-110086.
3. **The Joint Secretary (Transmission),**
Ministry of Power,
Shram Shakti Bhawan,
Rafi Marg, New Delhi- 110 004.
4. **The Director (Transmission),**
Ministry of Power, Govt, of India,
Shram Shakti Bhawan, Raft Marg,
New Delhi 110001
5. **The Chief Engineer (PSP & PA -I)**
Central Electricity Authority,
Sewa Bhawan, R.K. Puram,
New Delhi – 110066.
6. **The Chief Operating Officer,**
Central Transmission Utility of India Limited,
5th to 10th Floor, Ircon International Tower,
Tower No.-1, Plot No. 16, Sector 32,
Gurugram, Haryana - 122003



ANNEXURE 21 - FORMAT FOR FINANCIAL BID

Quoted Annual Transmission Charges: Rs. 40828.67 Million

Notes:

1. The Bidders are required to ensure compliance with the provisions of Clause 2.5.3 of this RFP.
2. Quotes to be in Rupees Millions and shall be up to two (2) decimal points.
3. The contents of this format shall be clearly typed.
4. The Financial Bid shall be digitally signed by the authorized signatory in whose name power of attorney as per Clause 2.5.2 is issued.
5. Ensure only one value for annual Transmission Charges is quoted. The same charge shall be payable every year to TSP for the term of TSA.



A handwritten signature in black ink, appearing to be "J. K. Singh", written over a horizontal line.





पावरग्रिड
POWERGRID

UNDERTAKING AND DETAILS OF EQUITY INVESTMENT

(A Government of India Enterprise)

Format 1: Bidders' Undertakings

Date: ...05/09/2024...

To,
Chief Executive Officer,
REC Power Development and Consultancy Limited
(A wholly owned subsidiary of REC Limited)
REC Corporate Head Quarter,
D Block, Plot No. 1 – 4,
Sec – 29 Gurugram – 122 001

Dear Sir,

Sub: Bidders' Undertakings In respect of Bid for selection of Bidder as TSP to establish Inter-State Transmission system for "Transmission System for Evacuation of Power from potential renewable energy zone in Khavda area of Gujarat under Phase-V (8 GW): Part A".

We hereby undertake on our own behalf and on behalf of the TSP, that if selected as the Successful Bidder for the Project:

1. The Project shall comply with all the relevant electricity laws, codes, regulations, standards and Prudent Utility Practices, environment laws and relevant technical, operational and safety standards, and we shall execute any agreements that may be required to be executed as per law in this regard.
2. We confirm that the Project shall also comply with the standards and codes as per Clause 1.6.1.2 of the RFP and the TSP shall comply with the provisions contained in the Central Electricity Regulatory Commission Grant of Connectivity, Long-term Access and Medium-term Open Access in Inter-state Transmission and related matters (Open Access) Regulations, 2009.
3. We give our unconditional acceptance to the RFP dated 04.12.2023 issued by the BPC and the RFP Project Documents, as amended, and undertake to ensure that the TSP shall execute all the RFP Project Documents, as per the provisions of this RFP.
4. We have submitted the Bid on the terms and conditions contained in the RFP and the RFP Project Documents. Further, the Financial Bid submitted by us is strictly as per the format provided in Annexure 21 of the RFP, without mentioning any deviations, conditions, assumptions or notes in the said Annexure.
5. Our Bid is valid up to the period required under Clause 2.8 of the RFP.
6. Our Bid has been duly signed by authorized signatory and stamped in the manner and to the extent indicated in this RFP and the power of attorney / Board resolution in requisite format as per RFP has been enclosed with this undertaking.
7. [NOT APPLICABLE].



Kaushal

कौशल किशोर / KAUSHAL KISHOR
ज्य. प्रबन्धक (डी.बी.सी.ओ.) / Dy. General Manager (TBCB)
पावर ग्रिड कॉर्पोरेशन ऑफ इंडिया लिमिटेड
Powergrid Corporation of India Ltd.
Govt. of India Enterprise
प्लॉट नं. 1-4, सेक्टर-29, गुरुग्राम-122001 (हरियाणा)
Plot No. 1-4, Sector-29, Gurugram-122001 (Haryana)



8. We confirm that our Bid meets the Scheduled COD of each transmission Element and the Project as specified below:

S. No.	Name of the Transmission Element	Scheduled COD in months from Effective Date	Percentage of Quoted Transmission Charges recoverable on Scheduled COD of the Element of the Project	Element(s) which are pre-required for declaring the commercial operation (COD) of the respective Element
1A. #	Establishment of 3000 MW, \pm 800 kV KPS2 (HVDC) [LCC] terminal station (2x1500 MW) (Bipole-1) along with associated interconnections with 400 kV HVAC Switchyard*.	48 months for Bipole1 (2x1500 MW) and all other elements [mentioned at Sl. 1A, 2A, 3, 4, 5 & 6] and 54 months for Bipole 2 (2x1500 MW) [mentioned at Sl. 1B & 2B] (from date of SPV transfer.)	31.03%	All Elements (except Bipole 2 (2x1500MW)) are required to be commissioned simultaneously in 48 months as their utilization is dependent on commissioning of each other. The Bipole2 (2x1500MW) shall be commissioned in 54 months.
2A. #	Establishment of 3000 MW, \pm 800 kV Nagpur (HVDC) [LCC] terminal station (2x1500 MW) (Bipole-1) along with associated interconnections with 400 kV HVAC Switchyard*			
1B. #	Establishment of 3000 MW, \pm 800 kV KPS2 (HVDC) [LCC] terminal station (2x1500 MW) (Bipole-2) along with associated interconnections with 400 kV HVAC Switchyard*.		31.03%	
2B. #	Establishment of 3000 MW, \pm 800 kV Nagpur (HVDC) [LCC] terminal station (2x1500 MW) (Bipole-2) along with associated interconnections with 400 kV HVAC Switchyard*			
3.	\pm 800 kV HVDC Bipole line (Hexa lapwing) between KPS2 (HVDC) and Nagpur (HVDC) (1200 km) (with Dedicated Metallic Return) (capable to evacuate 6000 MW with overload as specified)			
4.	Establishment of 6x1500 MVA, 765/400 kV ICTs at Nagpur S/s along with 2x330 MVAR (765 kV) & 2x125 MVAR, 420 kV bus reactors along with associated interconnections with HVDC Switchyard*. The 400 kV bus shall be established in 2 sections through 1 set of 400 kV bus sectionaliser so that 3x1500 MVA ICTs are placed in each section. The bus sectionaliser shall be normally closed and may be opened based on Grid requirement.	37.94%		
5.	LILO of Wardha - Raipur 765 kV one D/c line (out of 2xD/c lines) at Nagpur			

Keshor

काशी कौशल / KAUSHAL KUSHOR
 ज. प्रबन्धक (वि. वी. व. व.)/Dy. General Manager (T&CB)
 पावर ग्रिड कॉर्पोरेशन ऑफ इंडिया लिमिटेड
 Power Grid Corporation of India Ltd.
 (प्राप्त सरकार का उमर) / (A Govt. of India Enterprise)
 प्लॉट सं-0-2, सेक्टर-29, गुडगाँव-122 001 (हरियाणा)
 Plot No.-2, Sector-29, Gurgaon-122 001 (Haryana)



64
29

6.	Installation of 240 MVAR switchable line reactor at Nagpur end on each ckt of Nagpur - Raipur 765 kV D/c line			
----	---	--	--	--

* The 400 kV interconnections (along with all associated equipment/ bus extension, etc.) between HVDC & HVAC switchyards shall be implemented by the TSP.

Scope w.r.t. 6000 MW, \pm 800 kV HVDC [LCC] terminal station (4x1500 MW) at KPS2 & Nagpur has been split into 3000 MW, \pm 800 kV HVDC [LCC] terminal station (2x1500 MW) Bipole-1 (Sl. 1A & 2A) and 3000 MW, \pm 800 kV HVDC [LCC] terminal station (2x1500 MW) Bipole-2 (Sl. 1B & 2B) for sake of calculation of Percentage of Quoted Transmission Charges.

We agree that the payment of Transmission Charges for any Element irrespective of its successful commissioning on or before its Scheduled COD shall only be considered after the successful commissioning of Element(s) which are pre - required for declaring the commercial operation of such Element as mentioned in the above table.

Scheduled COD for the Project: 54 months from the date of SPV Transfer.

9. We confirm that our Financial Bid conforms to all the conditions mentioned in this RFP, and in particular, we confirm that:
- Financial Bid in the prescribed format of Annexure 21 has been submitted duly signed by the authorized signatory.
 - Financial Bid is unconditional.
 - Only one Financial Bid has been submitted.
10. We have neither made any statement nor provided any information in this Bid, which to the best of our knowledge is materially inaccurate or misleading. Further, all the confirmations, declarations and representations made in our Bid are true and accurate. In case this is found to be incorrect after our acquisition of **KHAVDA V-A POWER TRANSMISSION LIMITED**, pursuant to our selection as Selected Bidder, we agree that the same would be treated as a TSP's Event of Default under Transmission Service Agreement, and relevant provisions of Transmission Service Agreement shall apply.
11. We confirm that there are no litigations or other disputes against us which materially affect our ability to fulfill our obligations with regard to the Project as per the terms of RFP Project Documents.



Kaushor

कौशल किशोर / KAUSHAL KISHOR
 ज. प्रबन्धक (वि. प्र. वि. वि.) / Dy. General Manager (TBCB)
 पावर ग्रिड कॉर्पोरेशन ऑफ इंडिया लिमिटेड
 Power Grid Corporation of India Ltd.
 (भारत सरकार का उद्यम) / (A Govt. of India Enterprise)
 प्लॉट नं०-2, सेक्टर-29, गुरुग्राम-122 001 (हरियाणा)
 Plot No.-2, Sector-29, Gurgaon-122 001 (Haryana)

65

30



12. Power of attorney/ Board resolution as per Clause 2.5 of BOR is enclosed.

Kaushor
(Signature)

कौशल किशोर / KAUSHAL KISHOR
ज. सहायक (वि. स. स. डी.) / Dy. General Manager (TSCS)
पावर ग्रिड कॉर्पोरेशन ऑफ इंडिया लिमिटेड
Power Grid Corporation of India Ltd.
(भारत सरकार का उद्यम) / (A Govt. of India Enterprise)
प्लॉट नं०-2, सेक्टर-29, गुरुगाँव-122 001 (हरियाणा)
Plot No.-2, Sector-29, Gurgaon-122 001 (Haryana)

Name: Kaushal Kishor
Designation: Deputy General Manager



**STANDARD SINGLE STAGE REQUEST FOR PROPOSAL
DOCUMENT**

FOR

**SELECTION OF BIDDER AS TRANSMISSION SERVICE
PROVIDER THROUGH TARIFF BASED COMPETITIVE
BIDDING PROCESS**

TO

ESTABLISH INTER-STATE TRANSMISSION SYSTEM

FOR

**TRANSMISSION SYSTEM FOR EVACUATION OF POWER
FROM POTENTIAL RENEWABLE ENERGY
ZONE IN KHAYDA AREA OF GUJARAT UNDER PHASE-V (8
GW): PART A**

ISSUED BY

**REC Power Development and Consultancy Limited
(A wholly owned subsidiary of REC Limited)**

**Registered Office:
Core-4, SCOPE Complex,
7, Lodhi Road, New Delhi – 110 003
Email: pshariharan@recpdcl.in & tbc@recpdcl.in**

04.12.2023

ATTESTED TRUE COPY

Attested from Pg. 32 - Pg 35

Authorized Signatory

KHAYDA V-A POWER TRANSMISSION LIMITED



Information to be provided after opening of Initial Offer:

Only the lowest Initial Offer (s) shall be communicated to all the Qualified Bidders to participate in the e-reverse bidding process. During the e-reverse bidding process only the lowest prevailing bid should be visible to all the bidders on the electronic platform.

2.14 Enquiries

Written clarifications on the RFP and other RFP Project Documents as per Clause 2.3 and 2.4 may be sought from:

Chief Executive Officer,
REC Power Development and Consultancy Limited
(A wholly owned subsidiary of REC Limited)
REC Corporate Head Quarter,
D Block, Plot No. I – 4,
Sec – 29 Gurugram – 122 001
Email: pshariharan@recpdcl.in & tcb@recpdcl.in

2.15 Other Aspects

2.15.1. The draft of the Transmission Service Agreement has been attached to this RFP. In addition to above, the following documents have also been attached to this RFP:

a) Share Purchase Agreement

When the drafts of the above RFP Project Documents are provided by the BPC, these RFP Project Documents shall form part of this RFP as per Formats – 1 & 2 of Annexure 20.

Upon finalization of the RFP Project Documents after incorporating the amendments envisaged in Clause 2.4 of this RFP, all the finalized RFP Project Documents shall be provided by BPC to the Bidders at least fifteen (15) days prior to the Bid Deadline.

The Transmission Service Agreement and Share Purchase Agreement shall be signed in required number of originals so as to ensure that one (1) original is retained by each party to the Agreement(s) on the date of transfer of SPV.

2.15.2. Within ten (10) days of the issue of the Letter of Intent, the Selected Bidder shall:

- a) provide the Contract Performance Guarantee in favour of the Nodal Agency as per the provisions of Clause 2.12;
- b) execute the Share Purchase Agreement and the Transmission Service Agreement;
- c) acquire, for the Acquisition Price, one hundred percent (100%) equity shareholding of Khavda V A Power Transmission Limited from REC Power Development and Consultancy Limited, who shall sell to the Selected Bidder, the equity shareholding of Khavda V A Power Transmission Limited, along with all its related assets and liabilities;



Stamp duties payable on purchase of one hundred percent (100%) of the equity shareholding of Khavda V A Power Transmission Limited, along with all its related assets and liabilities, shall also be borne by the Selected Bidder.

Provided further that, if for any reason attributable to the BPC, the above activities are not completed by the Selected Bidder within the above period of ten (10) days as mentioned in this Clause, such period of ten (10) days shall be extended, on a day for day basis till the end of the Bid validity period.

- 2.15.3. After the date of acquisition of the equity shareholding of Khavda V A Power Transmission Limited, along with all its related assets and liabilities, by the Selected Bidder,
- i. the authority of the BPC in respect of this Bid Process shall forthwith cease and any actions to be taken thereafter will be undertaken by the Nodal Agency,
 - ii. all rights and obligations of Khavda V A Power Transmission Limited, shall be of the TSP,
 - iii. any decisions taken by the BPC prior to the Effective Date shall continue to be binding on the Nodal Agency and
 - iv. contractual obligations undertaken by the BPC shall continue to be fulfilled by the TSP.
 - v. Further, the TSP shall execute the Agreement(s) required, if any, under Central Electricity Regulatory Commission (Sharing of Inter-State Transmission Charges and Losses) Regulations as amended from time to time.
- 2.15.4. Within five (5) working days of the issue of the acquisition of the SPV by the Successful Bidder, the TSP shall apply to the Commission for grant of Transmission License and make an application to the Commission for the adoption of Transmission Charges, as required under Section – 63 of The Electricity Act 2003.
- 2.15.5. If the Selected Bidder / TSP fails or refuses to comply with any of its obligations under Clauses 2.15.2, 2.15.3 and 2.15.4, and provided that the other parties are willing to execute the Share Purchase Agreement and REC Power Development and Consultancy Limited is willing to sell the entire equity shareholding of Khavda V A Power Transmission Limited, along with all its related assets and liabilities, to the Selected Bidder, such failure or refusal on the part of the Selected Bidder shall constitute sufficient grounds for cancellation of the Letter of Intent. In such cases, the BPC / its authorized representative(s) shall be entitled to invoke the Bid Bond of the Selected Bidder.
- 2.15.6. If the TSP fails to obtain the Transmission License from the Commission, it will constitute sufficient grounds for annulment of award of the Project.
- 2.15.7. The annulment of award, as provided in Clauses 2.15.5 and 2.15.6 of this RFP, will be done by the Government on the recommendations of National Committee on Transmission. However, before recommending so, National Committee on Transmission will give an opportunity to the Selected Bidder / TSP to present their view point.
- 2.15.8. The annulment of the award, under Clause 2.15.5 or 2.15.6 of this RFP, shall be sufficient



Ref No.: RECPDCL/TBCB/Khavda Ph-V Part A/2024-25/2837

Date: 19.11.2024

**Executive Director, TBCB,
M/s Power Grid Corporation of India Limited**
'Saudamini', Plot no. 2, Sector – 29,
Gurugram – 122001 (Haryana)

Kind Attention: Mr. Pankaj Pandey

Sub: Establishment of Transmission System for "Transmission system for evacuation of power from Potential Renewable Energy Zone in Khavda area of Gujrat under Phase-V (8 GW): Part A" through tariff based competitive bidding process – Extension of Lol- regarding.

Ref.: RECPDCL/TBCB/ Khavda Ph-V Part A/2024-25/2502, Dated 24.10.2024

Dear Sir,

This is in reference to above referred Letter of Intent dated 24th October, 2024 issued to M/s Power Grid Corporation of India Limited for **Transmission system for evacuation of power from Potential Renewable Energy Zone in Khavda area of Gujrat under Phase-V (8 GW): Part A.**

To complete the activities mentioned under Clause 2.15.2, Clause no. 2.15.3 and Clause no. 2.15.4 of Request for Proposal (RFP) document, the last date for completion of various activities, is extended till 26th November, 2024.

Thanking You,

Yours faithfully,

(Satyapan Sahoo) 19/11/24
General Manager (Tech)



35

SHARE PURCHASE AGREEMENT

BETWEEN

REC POWER DEVELOPMENT AND CONSULTANCY LIMITED

AND

KHAVDA V-A POWER TRANSMISSION LIMITED

AND

POWER GRID CORPORATION OF INDIA LIMITED

Dated: 19th November, 2024



ATTESTED TRUE COPY
Attested from Pg 26 - Pg 55
[Signature]
Authorised Signatory
KHAVDA V-A POWER TRANSMISSION LIMITED



सत्यमेव जयते

INDIA NON JUDICIAL

Government of National Capital Territory of Delhi

e-Stamp

Certificate No.	: IN-DL87806509287765W
Certificate Issued Date	: 18-Nov-2024 10:54 AM
Account Reference	: SELFPRINT (PU)/ dl-self/ NEHRU/ DL-DLH
Unique Doc. Reference	: SUBIN-DL DL-SELF23788973586350W
Purchased by	: REC POWER DEVELOPMENT AND CONSULTANCY
Description of Document	: Article 5 General Agreement
Property Description	: CORE-4,SCOPE COMPLEX, 7, LODHI ROAD, NEW DELHI-110003
Consideration Price (Rs.)	: 0 (Zero)
First Party	: KHAVDA V A POWER TRANSMISSION LIMITED
Second Party	: POWER GRID CORPORATION OF INDIA LIMITED
Stamp Duty Paid By	: KHAVDA V A POWER TRANSMISSION LIMITED
Stamp Duty Amount(Rs.)	: 500 (Five Hundred only)

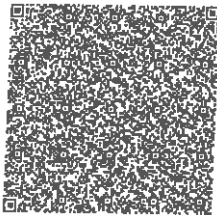

SELF PRINTED CERTIFICATE TO BE VERIFIED BY THE RECIPIENT AT WWW.SHCILESTAMP.COM

Please write or type below this line.

SHARE PURCHASE AGREEMENT

This SHARE PURCHASE AGREEMENT ('Agreement') made on the 19th day of November, 2024 at New Delhi by and between:

REC POWER DEVELOPMENT AND CONSULTANCY LIMITED, a company incorporated under the Companies Act, 1956, vide CIN-U40101DL2007GOI165779 having its registered office at Core 4, SCOPE Complex, 7, Lodhi Road, New Delhi 110 003, India (hereinafter referred to as "REC PDCL", which expression shall, unless it be repugnant to the context or meaning thereof, be deemed to mean and include its successors and permitted assigns)

of the FIRST PART;

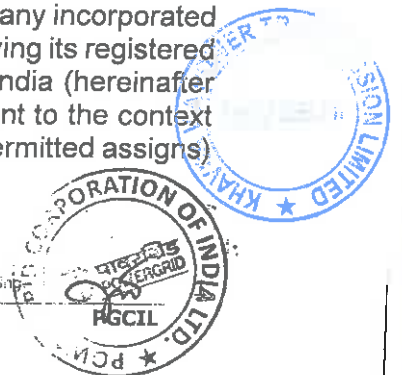
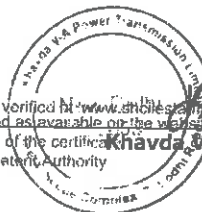
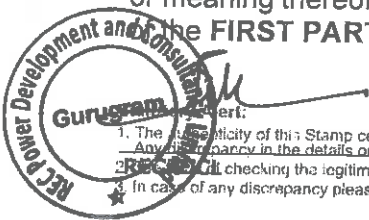

1. The legitimacy of this Stamp certificate should be verified by www.shcilestamp.com or using e-Stamp Mobile App of Stock Holding Corporation of India Limited. Any discrepancy in the details on this Certificate and as available on the website / Mobile App renders it invalid. 2. It is the responsibility of the user of the certificate to check the legitimacy of the certificate. 3. In case of any discrepancy please inform the Competent Authority.

Khavda V-A PTL

37

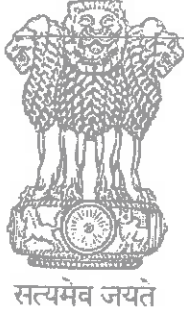

INDIA NON JUDICIAL

Government of National Capital Territory of Delhi

e-Stamp

Certificate No.	: IN-DL87813104342034W
Certificate Issued Date	: 18-Nov-2024 11:04 AM
Account Reference	: SELFPRINT (PU)/ dl-self/ NEHRU/ DL-DLH
Unique Doc. Reference	: SUBIN-DL DL-Self23802896642019W
Purchased by	: REC POWER DEVELOPMENT AND CONSULTANCY
Description of Document	: Article 5 General Agreement
Property Description	: CORE-4,SCOPE COMPLEX, 7, LODHI ROAD, NEW DELHI-110003
Consideration Price (Rs.)	: 0 (Zero)
First Party	: KHAVDA V A POWER TRANSMISSION LIMITED
Second Party	: POWER GRID CORPORATION OF INDIA LIMITED
Stamp Duty Paid By	: KHAVDA V A POWER TRANSMISSION LIMITED
Stamp Duty Amount(Rs.)	: 500 (Five Hundred only)

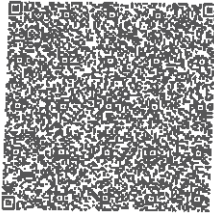

SELF PRINTED CERTIFICATE TO BE
VERIFIED BY THE RECIPIENT AT
WWW.SHCILESTAMP.COM

Please write or type below the

AND

KHAVDA V-A POWER TRANSMISSION LIMITED a company incorporated under the Companies Act,2013 vide CIN- U42202DL2023GOI421022, having its registered office at Core 4, SCOPE Complex, 7, Lodhi Road, New Delhi 110003, India (herein after referred to as "**Company**" which expression shall, unless repugnant to the context, mean and include its successors in interest) of the

SECOND PART;

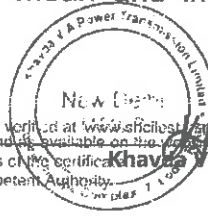

1. The authenticity of this Stamp certificate should be verified at www.shcilestamp.com or using e-Stamp Mobile App of Stock Exchange of India.
2. Any discrepancy in the details on this Certificate and its available on the e-Stamp Mobile App renders it invalid.
3. The responsibility of checking the legitimacy is on the users of the certificate.
4. In case of any discrepancy please inform the Competent Authority.



सत्यमेव जयते

INDIA NON JUDICIAL

Government of National Capital Territory of Delhi

e-Stamp

Certificate No.	: IN-DL87804892768130W
Certificate Issued Date	: 18-Nov-2024 10:52 AM
Account Reference	: SELFPRINT (PU)/ dl-self/ NEHRU/ DL-DLH
Unique Doc. Reference	: SUBIN-DL DL-SELF23785610108239W
Purchased by	: REC POWER DEVELOPMENT AND CONSULTANCY
Description of Document	: Article 5 General Agreement
Property Description	: CORE-4,SCOPE COMPLEX, 7, LODHI ROAD, NEW DELHI-110003
Consideration Price (Rs.)	: 0 (Zero)
First Party	: KHAVDA V A POWER TRANSMISSION LIMITED
Second Party	: POWER GRID CORPORATION OF INDIA LIMITED
Stamp Duty Paid By	: KHAVDA V A POWER TRANSMISSION LIMITED
Stamp Duty Amount(Rs.)	: 200 (Two Hundred only)

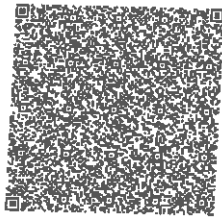

SELF PRINTED CERTIFICATE TO BE VERIFIED BY THE RECIPIENT AT WWW.SHCILESTAMP.COM

Please write or type below this to

AND

POWER GRID CORPORATION OF INDIA LIMITED, a company incorporated under the Companies Act, 1956 vide CIN-L40101DL1989GOI038121 and having its registered office at B-9, Qutab Institutional Area, Katwaria Sarai, New Delhi-110016 (hereinafter referred to as "Selected Bidder" which expression shall, unless repugnant to the context or meaning thereof, be deemed to include its successors and permitted assigns) of the THIRD PART.

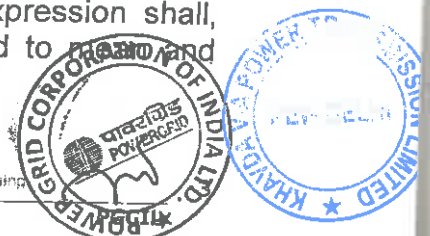
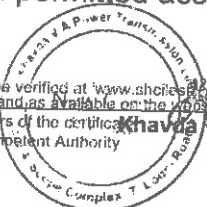

The authenticity of this Stamp certificate should be verified at www.shcilestamp.com or using e-Stamp Mobile App of Stock Exchange of India. In case of any discrepancy please inform the Competent Authority.

39

WHEREAS:

- A. The Ministry of Power, Government of India, vide its notification no. 3733 [F. No. 15/3/2018-Trans-Pt(1)] dated 04.09.2023 has appointed REC Power Development and Consultancy Limited to be the Bid Process Coordinator (BPC) for the purpose of selection of Bidder as Transmission Service Provider (TSP) to establish “**Transmission System for Evacuation of power from potential renewable energy zone in Khavda area of Gujarat under Phase-V (8 GW): Part A**” through tariff based competitive bidding process (hereinafter referred to as the “Project”).
- B. In accordance with the Bidding Guidelines, the BPC had initiated a competitive bidding process through issue of RFP for selecting a Successful Bidder to build, own, operate and transfer the Project comprising of the Elements mentioned in **Schedule 2** of the TSA. BPC had initiated this process in accordance with and on the terms and conditions mentioned in the RFP Project Documents (as defined hereinafter).
- C. BPC has incorporated the Company and has undertaken the preliminary studies, obtained certain approvals, etc. regarding the Project on behalf of the Company
- D. REC PDCL along with the Nominees hold one hundred per cent (100%) of the total issued and paid up equity share capital of the Company.
- E. Pursuant to the said Bid Process, Power Grid Corporation of India Limited has been identified as the Selected Bidder vide Letter of Intent dated 24th October 2024 issued by the BPC in favour of the Selected Bidder.
- F. As envisaged in the RFP, the Shares Seller (as defined hereinafter) has agreed to sell the Sale Shares (as defined hereinafter) to the Selected Bidder and the Selected Bidder has agreed to purchase the Sale Shares from the Shares Seller, subject to and on the terms and conditions set forth in this Agreement.

NOW THEREFORE, IN CONSIDERATION OF THE MUTUAL COVENANTS AND AGREEMENTS SET FORTH IN THIS AGREEMENT AND FOR OTHER GOOD AND VALUABLE CONSIDERATION, THE PARTIES HEREBY AGREE AS FOLLOWS:

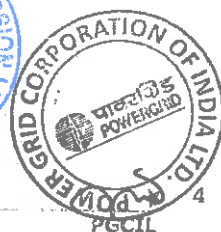
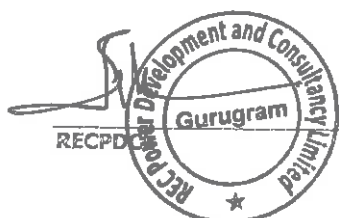

1. DEFINITIONS

1.1 Capitalised terms in this Agreement, unless defined in this Agreement shall, in so far as the context admits, have the same meaning in this Agreement as has been ascribed to them in the TSA.

1.2 Additionally, the following terms shall have the meaning hereinafter respectively assigned to them herein below:

- (i) **“Acquisition Price”** shall mean INR 18,95,28,836 /- (Rupees Eighteen Crore Ninety-Five Lakh Twenty-Eight Thousand Eight Hundred Thirty-Six Only) which is the aggregate consideration payable by the Selected Bidder towards purchase of the Sale Shares at par and for taking over of all assets and liabilities of the Company as on the Closing Date subject to adjustment as per the audited accounts of the Company as on the Closing Date;
- (ii) **“Agreement”** or **“the Agreement”** or **“this Agreement”** shall mean this Share Purchase Agreement and shall include the recitals and/or annexures attached hereto, and the contracts, certificates, disclosures and other documents to be executed and delivered pursuant hereto, if any, and any amendments made to this Agreement by the Parties in writing;
- (iii) **“Bid Process”** shall mean the competitive bidding process initiated by the BPC, by issuance of RFP for selecting a Successful Bidder to build, own, operate and transfer the Project in accordance with and on the terms and conditions mentioned in the RFP Project Documents;
- (iv) **“Board”** shall mean the board of directors of the Company;
- (v) **“Closing Date”** shall mean a mutually agreed date between the Parties falling within the period as mentioned in clause 2.15.2 of RFP or on failure of such mutual agreement between the Parties shall be the date falling on the last date of such period;
- (vi) **“Encumbrance”** shall mean any mortgage, pledge, lien, charge, security assignment, hypothecation, trust, encumbrance or any other agreement having the effect of creating security interest;
- (vii) **“Letter of Intent”** shall have the meaning ascribed thereto under the Bid Documents;
- (viii) **“Nominees”** shall mean the Persons, who are named in Annexure A of this Agreement, holding the Sale Shares as nominees of REC PDCL;

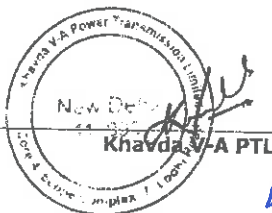
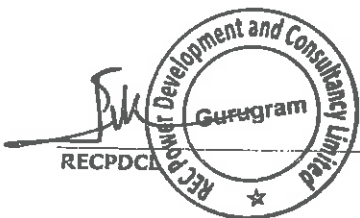

- (ix) **"Party"** shall mean REC PDCL, Company and the Selected Bidder, referred to individually, and **"Parties"** shall mean REC PDCL, Company and the Selected Bidder collectively referred to, as relevant;
- (x) **"Person"** shall include an individual, an association, a corporation, a partnership, a joint venture, a trust, an unincorporated organisation, a joint stock company or other entity or organisation, including a government or political subdivision, or an agency or instrumentality thereof, and/or any other legal entity;
- (xi) **"RFP Project Documents"** shall mean the following documents, referred to collectively:
- a. Transmission Service Agreement; and
 - b. this Agreement.
- (xii) **"Representations and Warranties"** shall mean the representations and warranties mentioned in Clause 4 hereto;
- (xiii) **"RoC"** shall mean the Registrar of Companies;
- (xiv) **"Sale Shares"** shall mean 50,000 shares, representing one hundred percent (100%) of the total issued, subscribed and fully paid-up equity share capital of the Company held by the Shares Seller and Nominees as more particularly described in Annexure A attached hereto;
- (xv) **"Shares"** shall mean the fully paid-up equity shares of Company, of face value Rs. 10 each;
- (xvi) **"Shares Seller"** shall mean REC PDCL; and
- (xvii) **"Transmission Service Agreement"** or **"TSA"** means the agreement titled 'Transmission Service Agreement' to be executed on 19th November, 2024 between Central Transmission Utility of India Limited (CTUIL) and Khavda V-A Power Transmission Limited, pursuant to which the TSP shall build, own, operate and transfer the Project and make available the assets of the Project on a commercial basis.

1.3 Interpretation Clause

Unless the context otherwise requires, the provisions of the TSA relating to the interpretation of the TSA shall apply to this Agreement as if they were set out in full in this Agreement and to this end are incorporated herein by reference.



2. TRANSFER OF SHARES

- 2.1 Subject to the terms and conditions of this Agreement, the Shares Seller agrees to sell and transfer to the Selected Bidder and the Selected Bidder hereby agrees to purchase from the Shares Seller, the Sale Shares free from Encumbrances together with all assets and liabilities of the Company with rights and benefits attached thereto in consideration of the Acquisition Price and the covenants, undertakings and the agreements of the Selected Bidder contained in this Agreement.
- 2.2 The Shares Seller hereby undertakes to cause the Nominees to transfer part of the Sale Shares held by them as nominees of the Shares Seller to the Nominees of Selected Bidder and execute any documents required to deliver good title to the Sale Shares to the Selected Bidder.

3. CLOSING

- 3.1 Prior to the Closing Date, the Selected Bidder shall provide to the Shares Seller, valid share transfer forms duly stamped with requisite amount of stamp duty payable on the transfer of the Sale Shares ("**Share Transfer Forms**").
- 3.2 On the Closing Date, the Shares Seller shall hand over to the Selected Bidder or its authorised representative, the original share certificates representing the Sale Shares ("**Sale Share Certificates**") executed by the Shares Seller and the Nominees, simultaneously against the Selected Bidder handing over to the Shares Seller, demand drafts drawn in favour of the Shares Seller or by confirmation of RTGS transfer in favour of the Shares Seller, for the Acquisition Price payable to it.

Provided that prior to the handing over of the Sale Share Certificates to the Selected Bidder as mentioned above, the Selected Bidder shall provide satisfactory evidence to REC PDCL that on the Closing Date, the Selected Bidder has furnished the Contract Performance Guarantee to Central Transmission Utility of India Limited (CTUIL) and is in a position to comply with all other requirements of Clause 2.15.2 of the RFP.

- 3.3 The Selected Bidder shall immediately upon receiving the Sale Share Certificates and the Share Transfer Forms, duly execute the Share Transfer Forms and duly lodge the Share Transfer Forms and the Share Certificates with the Company along with the names of its nominees to be appointed on the Board of the Company and the address within the jurisdiction of the Registrar of Companies of New Delhi and Haryana, which would be the new registered office of the Company. The Company shall, upon receipt of the said documents from the Selected Bidder, do the following:

- (i) Immediately on the Closing Date convene a meeting of the Board wherein the Board shall pass the following necessary resolutions:

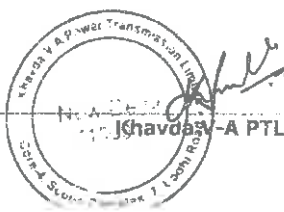
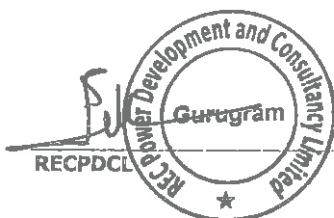

- (a) approving the transfer of the Shares constituting the Sale Shares from the Shares Seller and the Nominees to the name of the **Power Grid Corporation of India Limited** and its nominees and transfer of all assets and liabilities of the Company as on Closing Date;
- (b) approving the **Power Grid Corporation of India Limited** and its nominees as the members of the Company and entering the name of the **Power Grid Corporation of India Limited** and its nominees in the register of members.
- (c) changing the address of the registered office of the Company to the new address as provided by the Selected Bidder as per clause 3.3 above.
- (d) appointing the nominees of the Selected Bidder on the Board and accepting the resignations of the other existing Directors on the Board and the Chair of the meeting which was taken by one of the existing Directors shall be vacated and appointment of a new Chairman who shall be one of the newly appointed Director, for the rest of the meeting.

Immediately pursuant to the acceptance of resignation of the existing Directors and appointment of new Chairman, the newly constituted Board of Directors shall continue with the meeting and pass the following resolution:

- (e) terminating all the authorizations granted regarding the business and/or operations of the Company or the operations of the bank accounts of the Company, with prospective effect; and
 - (f) acknowledging and accepting the terms and conditions as contained in the executed copies of the RFP Project Documents and to abide by the provisions contained therein.
- (ii) Enter the name of the **Power Grid Corporation of India Limited** and its nominees as the legal and beneficial owner of the Sale Shares, free of all Encumbrances, in the register of members of the Company;
 - (iii) Make the necessary endorsements on the Sale Share Certificates, indicating the name of the **Power Grid Corporation of India Limited** and its nominees as the legal and beneficial owner of the Sale Shares evidenced there under;
 - (iv) Return the original Sale Share Certificates, duly endorsed in the name of the **Power Grid Corporation of India Limited** and its nominees, to the **Power Grid Corporation of India Limited** and its nominees as the case may be or its authorized representative;

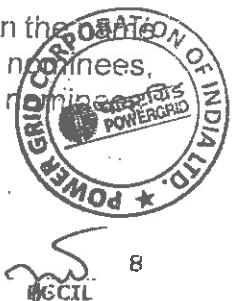
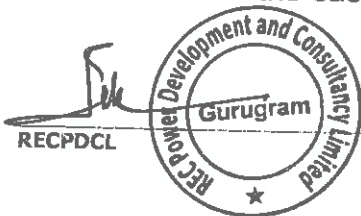

- (v) Handover all the statutory registers and records, if any, of the Company to the Selected Bidder.
 - (vi) Handover certified true copies of the Board resolution passed by the Company as per (i) (a) to (i) (f) of Clause 3.3 (i) to the Central Transmission Utility of India Limited (CTUIL).
- 3.4 The Parties to this Agreement agree to take all measures that may be required to ensure that all the events contemplated in the **Clauses 3.1 to 3.3** above on the Closing Date are completed on the same day.

Notwithstanding the provisions of **Clause 3.3** hereto, all proceedings to be taken and all documents to be executed and delivered by the Parties at the Closing Date shall be deemed to have been taken and executed simultaneously and no proceedings shall be deemed to have been taken nor documents executed or delivered until all have been taken, executed and delivered.

- 3.5 The Selected Bidder hereby acknowledges and agrees that after the date of acquisition of one hundred percent (100%) of the Shares of the Company by the Selected Bidder as per Clause 3.3, (a) the authority of the BPC in respect of the Bid Process shall forthwith cease and any actions to be taken thereafter regarding the Bid Process will be undertaken by the Central Transmission Utility of India Limited (CTUIL) themselves, (b) all rights and obligations of the BPC shall cease forthwith, (c) all other rights and obligations of the Company shall be of the TSP and (d) any decisions taken by the BPC on behalf of the Company prior to the date of acquisition, shall continue to be binding on the Company and/or Central Transmission Utility of India Limited (CTUIL) as the case may be.
- 3.6 This Agreement shall be effective from the date of its signing by the Parties and shall remain in force until all the obligations of the respective Parties under Clause 3.3 hereto are fulfilled.

4. REPRESENTATIONS AND WARRANTIES

- 4.1 The Selected Bidder hereby represents and warrants to the Shares Seller that:

- 4.1.1 The Selected Bidder has full legal right, power and authority to enter into, execute and deliver this Agreement and to perform the obligations, undertakings and transactions set forth herein, and this Agreement has been duly and validly executed and delivered by the Selected Bidder and constitutes its legal, valid and binding obligations, enforceable against it in accordance with its terms.

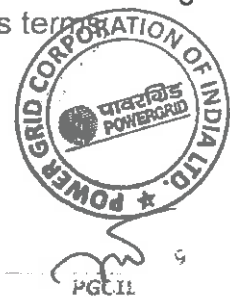
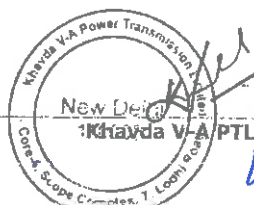

- 4.1.2 The execution, delivery and performance of this Agreement by the Selected Bidder (i) will not violate or contravene any provision of the Memorandum of Association or Articles of the Selected Bidder, (ii) will not violate or contravene any law, statute, rule, regulation, licensing requirement, order, writ, injunction or decree of any court, governmental instrumentality or other regulatory, governmental or public body, agency or authority by which the Selected Bidder is bound or by which any of its and/or their properties or assets are bound, and (iii) except to the extent that the same have been duly and properly completed or obtained, will not require any filing with, or permit, consent or approval of or license from, or the giving of any notice to, any court, governmental instrumentality or other regulatory, governmental or public body, agency or authority, joint venture party, or any other entity or person whatsoever; and
- 4.1.3 The Selected Bidder is not restricted in any manner whatsoever, including without limitation, on account of any judicial or governmental order, action or proceeding, or any contractual obligation assumed by the Selected Bidder, from purchasing the Sale Shares from the Shares Seller in the manner provided for in this Agreement.
- 4.2 The Shares Seller hereby represents and warrants to the Selected Bidder that;
- 4.2.1 The Shares Seller and the Nominees are the legal and beneficial owners of the Sale Shares, free and clear of any Encumbrance and the delivery to the Selected Bidder of the Sale Shares pursuant to the provisions of this Agreement will transfer to the Selected Bidder a good title to the Sale Shares.
- 4.2.2 The Shares Seller has full legal right, power and authority to enter into, execute and deliver this Agreement and to perform the obligations, undertakings and transactions set forth herein. The execution, delivery and performance of this Agreement will not violate the Memorandum and Articles of Association of the Shares Seller or contravene any contract by which it is bound.
- 4.2.3 The Shares Seller has obtained requisite authorizations to sell and transfer the Sale Shares to the Selected Bidder. The Shares Seller also represent that it is not prevented from transferring and selling the Sale Shares. Also, to the best of its knowledge, the Sale Shares are not the subject matter of any claim or pending proceeding or threatened by any legal proceeding made by any third party.
- 4.3 Except as specified in Clause 4.2 above, the Shares Seller shall not be deemed to have, made any representation or warranty whatsoever, whether express or implied, in relation to the Sale Shares or Company, including but not limited to any implied warranty or representation as to the business affairs of Company.

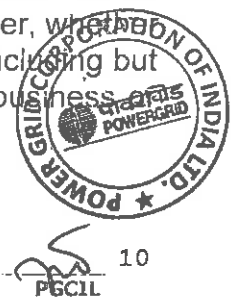
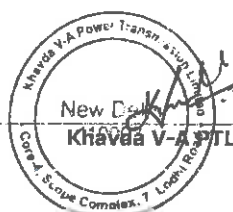

- 4.4 The Representations and Warranties are given as at the date of this Agreement except that where a Representation and Warranty is expressed to be made as at another date, the Representation and Warranty is given with respect to that date only.
- 4.5 Each Representation and Warranty is to be construed independently of the others and is not limited by reference to any other Warranty. The Representations, Warranties and undertakings contained in this **Clause 4** hereto or in any document delivered pursuant to or in connection with this Agreement are continuing in nature and shall survive the Closing Date for a period of one (1) year.
- 4.6 The Parties represent to each other that all Representations and Warranties provided herein by the respective Party shall be true as of Closing Date.

5. OBLIGATIONS OF THE SELECTED BIDDER

The Selected Bidder agrees that the Shares Seller shall not be liable in any manner, nor shall it assume any responsibility or liability whatsoever, in respect of the business of the Company and its operations or activities, arising after the Closing Date, to any Person or any authority, central, state, local or municipal or otherwise and the same shall be the sole responsibility of the Selected Bidder.

6. MISCELLANEOUS

6.1 NOTICES

- a) All notices to be given under this Agreement shall be in writing and in the English language.
- b) All notices must be delivered personally or by registered or certified mail or by recognised courier to the addresses below:

Selected Bidder: **Power Grid Corporation of India Limited,**
B-9, Qutab Institutional Area, Katwaria Sarai,
New Delhi-110016

REC PDCL: **REC Power Development and Consultancy Limited**
Core-4, SCOPE Complex, 7, Lodhi Road, New
Delhi-110003

Company: **Khavda V-A Power Transmission Limited**
Core-4, SCOPE Complex, 7, Lodhi Road, New
Delhi-110003

- c) Any Party may by notice of at least fifteen (15) days to the other Parties change the address and / or addresses to which such communications to it are to be delivered or mailed.

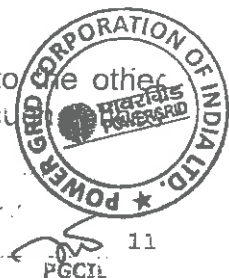
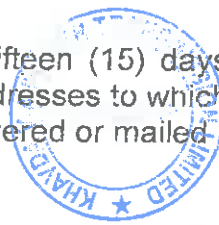

47

6.2 RESOLUTION OF DISPUTES

- 6.2.1 If any dispute arises between the Parties, in connection with the validity, interpretation, implementation or alleged breach of any provision of this Agreement (“Dispute”), the disputing Parties hereto shall endeavor to settle such Dispute amicably. The attempt to bring about an amicable settlement shall be considered to have failed if not resolved within sixty (60) days from the date of the Dispute.
- 6.2.2 If the Parties are unable to amicably settle the Dispute in accordance with Clause 6.2.1 within the period specified therein, any of the Parties shall be entitled to within thirty (30) days after expiry of the aforesaid period, refer the Dispute to the Chief Executive Officer/Director of REC PDCL and Chief Executive/ Managing Director of the Selected Bidder for resolution of the said Dispute. The attempt to bring about such resolution shall be considered to have failed if not resolved within thirty (30) days from the date of receipt of a written notification in this regard.
- 6.2.3 In the event the Dispute is not settled in accordance with Clause 6.2.2 above, any Party to the Dispute shall be entitled to serve a notice invoking this Clause and making a reference to a sole arbitrator. If the Parties to the Dispute cannot agree as to the appointment of the sole arbitrator within thirty (30) days of receipt of the notice of the Party making the reference, then the Shares Seller along with the Company shall appoint one arbitrator and the Selected Bidder shall appoint one arbitrator and the two arbitrators, so appointed shall appoint a third arbitrator. However, after the Closing Date, in such an event the Shares Seller shall appoint one arbitrator and the Selected Bidder along with the Company shall appoint one arbitrator and the two arbitrators, so appointed shall appoint the third arbitrator.
- 6.2.4 The place of the arbitration shall be New Delhi. The Arbitration proceedings shall be governed by the Arbitration and Conciliation Act, 1996.
- 6.2.5 The proceedings of arbitration shall be in English language.
- 6.2.6 The arbitrator’s award shall be substantiated in writing. The arbitrators shall also decide on the costs of the arbitration proceedings. In case the arbitrators have not decided on the costs of the arbitration proceedings, each Party to the Dispute shall bear its own costs, in relation to the arbitration proceedings.

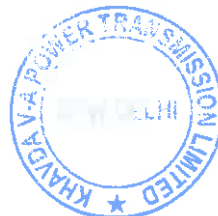

6.3 AUTHORISED PERSON

For the purposes of this Agreement, the Selected Bidder is represented by Shri Satyaprakash Dash, Company Secretary, pursuant to an authorization granted to Shri Satyaprakash Dash, Company Secretary through necessary Board resolutions. Further, Shri Satyaprakash Dash, Company Secretary is also authorized by such resolutions to take any decision which may be required to be taken, do all acts and execute all documents which are or may be required by the Selected Bidder for the proper and effective fulfillment of the rights and obligations under this Agreement. Any action taken or document executed by Shri Satyaprakash Dash, Company Secretary shall be deemed to be acts done or documents executed by the Selected Bidder and shall be binding on the Selected Bidder.

6.4 RESERVATION OF RIGHTS

No forbearance, indulgence or relaxation or inaction by any Party at any time to require performance of any of the provisions of this Agreement shall in any way affect, diminish or prejudice the right of such Party to require performance of that provision, and any waiver or acquiescence by any Party of any breach of any of the provisions of this Agreement shall not be construed as a waiver or acquiescence of any continuing or succeeding breach of such provisions, a waiver of any right under or arising out of this Agreement or acquiescence to or recognition of rights other than that expressly stipulated in this Agreement.

6.5 CUMULATIVE RIGHTS

All remedies of either Party under this Agreement whether provided herein or conferred by statute, civil law, common law, custom or trade usage, are cumulative and not alternative and may be enforced successively or concurrently.

6.6 PARTIAL INVALIDITY

If any provision of this Agreement or the application thereof to any person or circumstance shall be invalid or unenforceable to any extent, the remainder of this Agreement and the application of such provision to persons or circumstances other than those as to which it is held invalid or unenforceable shall not be affected thereby, and each provision of this Agreement shall be valid and enforceable to the fullest extent permitted by law. Any invalid or unenforceable provision of this Agreement shall be replaced with a provision, which is valid and enforceable and most nearly reflects the original intent of the unenforceable provision.

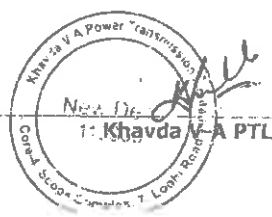
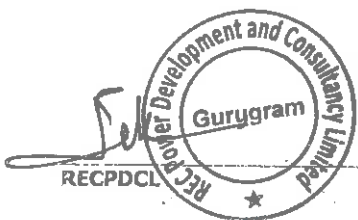

6.7 TERMINATION

If (i) the Closing does not occur on the Closing Date for any reason whatsoever, or (ii) the Letter of Intent is withdrawn or terminated for any reason, or (iii) due to termination of the TSA by the Central Transmission Utility of India Limited (CTUIL) in accordance with Article 3.3.2 or Article 13 of the TSA thereof, REC PDCL shall have a right to terminate this Agreement forthwith by giving a written notice to the other Parties hereto.

6.8 AMENDMENTS

No modification or amendment of this Agreement and no waiver of any of the terms or conditions hereof shall be valid or binding unless made in writing and duly executed by all the Parties.

6.9 ASSIGNMENT

This Agreement and the rights and liabilities hereunder shall bind and inure to the benefit of the respective successors of the Parties hereto, but no Party hereto shall assign or transfer its rights and liabilities hereunder to any other Person without the prior written consent of the other Parties, which will not be unreasonably withheld.

6.10 ENTIRE AGREEMENT

This Agreement constitutes the entire Agreement between the Parties with respect to the subject matter herein and supersedes and cancels any prior oral or written agreement, representation, understanding, arrangement, communication or expression of intent relating to the subject matter of this Agreement.

6.11 COSTS

Each of the Parties hereto shall pay their own costs and expenses relating to the negotiation, preparation and execution of this Agreement and the transactions contemplated by this Agreement.

The Selected Bidder shall be liable to bear and pay the costs in respect of this Agreement and transfer of Sale Shares.

6.12 RELATIONSHIP

None of the provisions of this Agreement shall be deemed to constitute a partnership between the Parties hereto and no Party shall have any authority to bind the other Party otherwise than under this Agreement or shall be deemed to be the agent of the other in any way.

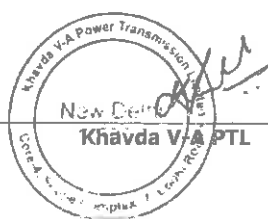

50

6.13 GOVERNING LAW AND JURISDICTION

This Agreement shall be governed by and construed in accordance with the laws of India and shall be subject to the exclusive jurisdiction of the courts of Delhi.

6.14 COUNTERPARTS

This Agreement may be executed in counterparts by the Parties and each fully executed counterpart shall be deemed to be original.

6.15 CONFIDENTIALITY

The Parties undertake to hold in confidence and not to disclose the terms and conditions of the transaction contemplated hereby to third parties, except:

- (a) to their professional advisors;
- (b) to their officers, employees, agents or representatives, who need to have access to such information for the proper performance of their activities;
- (c) disclosures required under Law;

without the prior written consent of the other Parties.

Provided that the Central Transmission Utility of India Limited (CTUIL) and REC PDCL may at any time, disclose the terms and conditions of transactions contemplated hereby to any person, to the extent stipulated under the law or the Bidding Guidelines.

6.16 INDEMNIFICATION

The Parties hereby agree that transfer of Sale Shares to the Selected Bidder shall vest all the rights, privileges, licenses, responsibilities, liabilities and other obligations pertaining to the Company in the Selected Bidder.

- The Selected Bidder hereby agrees that the Selected Bidder shall not be entitled to any claims or initiate any legal proceedings by itself or through the Transmission Service Provider against the Shares Seller, its directors, officers, employees and the subscribers including the members of any committees appointed by them in respect of any actions or decisions taken by any of them up to the Closing Date in furtherance of the Project referred to in recital A of this Agreement.

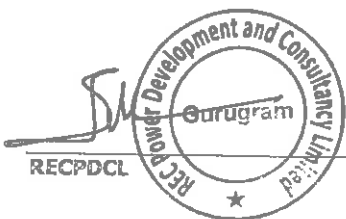

- Further, the Selected Bidder hereby indemnifies and holds harmless at all times the Shares Seller against all past, present and future third party claims and liabilities arising out of actions or decisions taken by any of the persons or bodies referred to in Clause 6.3 up to the Closing Date in furtherance of the Project referred to above or otherwise concerning the Company. All such actions shall be defended by the Selected Bidder either itself or through the TSP at its own cost.
- The Parties hereby agree that the provisions of this clause shall survive the termination of this Agreement.

6.17 SURVIVAL

The provisions of Clause 1 (Definitions and Interpretation), Clause 4 (Representations and Warranties), Clause 6.2 (Resolution of Disputes), Clause 6.7 (Termination), Clause 6.15 (Confidentiality), Clause 6.16 (Indemnification) and other representations, warranties, covenants and provisions contained herein that by their nature are intended to survive, shall survive the termination of this Agreement

6.18 FORCE MAJEURE

No party shall be liable for its inability or delay in performing any of its obligations hereunder if such delay is caused by circumstances beyond the reasonable control of the party including delay caused through flood, riot, Act of God, lighting civil commotion, storm, tempest and earthquake.

IN WITNESS WHEREOF, THE PARTIES HERETO HAVE CAUSED THIS AGREEMENT TO BE DULY EXECUTED AND DELIVERED AS OF THE DAY AND YEAR FIRST ABOVE WRITTEN

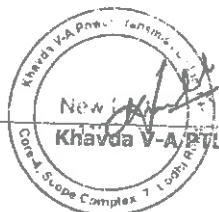

RECPDCL

PGCIL

16

52

SIGNED AND DELIVERED by the within named **REC POWER DEVELOPMENT AND CONSULTANCY LIMITED** by the hand of Sh. TSC Bosh, CEO

(Authorised pursuant to the resolution passed by its Board of Directors in its meeting held on 24th October, 2024)

IN THE PRESENCE OF:

WITNESS:

(Name and address)

1. SATYABAN SAHOO
GM (TECH)

2. Anil Kumar Perrak
Chief Managers (Emgg.)





(Core-4, SCOPE Complex, 7,
Lodhi Road, New Delhi-110003)

(Core-4, SCOPE Complex, 7,
Lodhi Road, New Delhi-110003)

SIGNED AND DELIVERED by the within named **KHAVDA V-A POWER TRANSMISSION LIMITED** by the hand of Sh. Jaspal Singh Kushwaha, Director

(Authorised pursuant to the resolution passed by its Board of Directors in its meeting held on 19th November, 2024)

WITNESS:

(Name and address)

1. (CH. V. LAKSHMANACHARYULU)
GM & HOD (F), RECPDCL

2. RITU MADAN ARORA
CM (CD) - REC

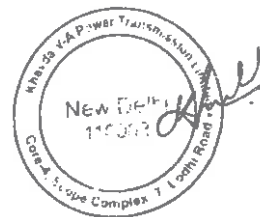





(Core-4, SCOPE Complex, 7,
Lodhi Road, New Delhi-110003)

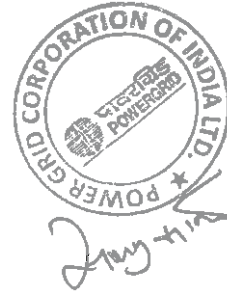

(Core-4, SCOPE Complex, 7,
Lodhi Road, New Delhi-110003)

SIGNED AND DELIVERED by the within named **POWER GRID CORPORATION OF INDIA LIMITED** by the hand of Shri Satyaprakash Dash, Company Secretary



(Authorised pursuant to the resolution passed by Board of Directors in its meeting held on 19th January, 2024)

WITNESS:
(Name and address)

1. 
ROHIT JAIN
POWERGRID

B-9, Qutab Institutional Area,
Katwaria Sarai, New Delhi-110016

2. 
VIKAS KUMAR
POWERGRID

B-9, Qutab Institutional Area,
Katwaria Sarai, New Delhi-110016



ANNEXURE A**DESCRIPTION OF THE SALE SHARES**

S. NO.	NAME OF THE SHAREHOLDER(s)	NUMBER OF EQUITY SHARES HELD	PERCENTAGE OF THE TOTAL PAID UP EQUITY CAPITAL
1.	REC POWER DEVELOPMENT AND CONSULTANCY LIMITED	49,994	99.988
2.	Shri Thangarajan Bosh*	1	0.002
3.	Shri Sahab Narain *	1	0.002
4.	Shri Satyaban Sahoo*	1	0.002
5.	Shri Alok Singh*	1	0.002
6.	Shri Mohan Lal Kumawat*	1	0.002
7.	Shri Arvind Kumar*	1	0.002
	Total	50,000	100.000

* Held as nominee of REC PDCL.

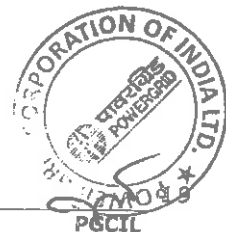
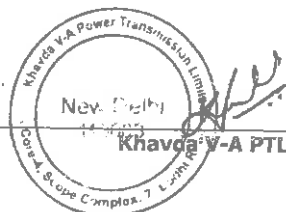

TRANSMISSION SERVICE AGREEMENT

FOR

**DEVELOPMENT AND OPERATION OF INTER-
STATE TRANSMISSION SYSTEM**

**FOR TRANSMISSION OF ELECTRICITY
THROUGH TARIFF BASED COMPETITIVE
BIDDING FOR**

**TRANSMISSION SYSTEM FOR EVACUATION OF
POWER FROM POTENTIAL RENEWABLE
ENERGY**

**ZONE IN KHAVDA AREA OF GUJARAT UNDER
PHASE-V (8 GW): PART A**

BETWEEN THE

**CENTRAL TRANSMISSION UTILITY OF INDIA
LIMITED
(NODAL AGENCY)**

AND

KHAVDA V-A POWER TRANSMISSION LIMITED

November..19th.., 2024



ATTESTED TRUE COPY
Attested from pg 56 - pg 308
Authorized Signatory
KHAVDA V-A POWER TRANSMISSION LIMITED

A

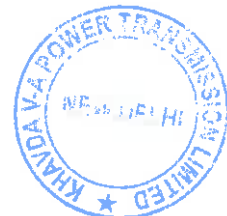

56

Transmission Service Agreement

CONTENTS

1	Definitions and Interpretations.....	6
2	Effectiveness and Term of Agreement.....	18
3	Conditions Subsequent.....	20
4	Development of the Project.....	24
5	Construction of the Project.....	28
6	Connection and commissioning of the Project.....	32
7	Operation and Maintenance of the Project.....	37
8	Availability of the project.....	38
9	Insurances.....	39
10	Billing and Payment of Transmission Charges.....	41
11	Force Majeure.....	42
12	Change in Law.....	46
13	Events of Default and Termination.....	48
14	Liability and Indemnification.....	53
15	Assignments and Charges.....	58
16	Governing Law and Dispute Resolution.....	60
17	Representation and Warranties.....	62
18	Independent Engineer.....	64
19	Miscellaneous Provisions.....	66

Central Transmission Utility of India Limited



2

Khavda V-A Power Transmission Limited

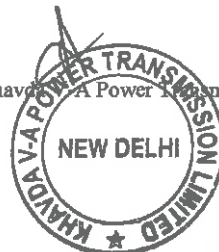

57

Transmission Service Agreement
Indian-Non Judicial Stamp
Haryana Government

Serial

Date :21/10/2024

Certificate No. G0U2024J4443

Stamp Duty Paid : ₹ 101

GRN No. 122791824

Penalty : ₹ 0

Deponent

Name: Central Transmission utility of India Ltd

H.No/Floor : 2

Sector/Ward : 29

Landmark : Na

City/Village : Gurugram

District : Gurugram

State : Haryana

Phone : 98*****10



Purpose : ARTICLE 5 GENERAL AGREEMENT to be submitted at Concerned office

THIS TRANSMISISON SERVICE AGREEMENT (hereinafter referred to as "TSA" or "Agreement" or "the Agreement" or "this Agreement") is made on the ...19th... [Insert day] of November... [Insert month] of Two Thousand and Twenty-Four.

BETWEEN:

The **Central Transmission Utility of India Limited**, having its registered office at Plot No.2, Sector 29, Gurugram, Haryana-122001 & correspondence address at Floor No. 5-10, Tower 1, Plot No. 16, IRCON International Tower, Institutional Area, Sector 32, Gurugram, Haryana – 122001 acting as a Nodal Agency (referred to as the "Nodal Agency"), which expression shall unless repugnant to the context or meaning thereof include its successors, and permitted assigns) as Party of the one part;

AND

Khavda V-A Power Transmission Limited, incorporated under the Companies Act, 2013, having its registered office at Core-4, Scope Complex 7, Lodhi Road Delhi, South Delhi, Delhi 110003 (herein after referred to as "Transmission Service Provider" or "TSP" or "ISTS Licensee", which expression shall unless repugnant to the context or meaning thereof include its successors, and permitted assigns) as Party of the other part;

("Nodal Agency" and "TSP" are individually referred to as "Party" and collectively as the "Parties")

Central Transmission Utility of India Limited

3

Khavda V-A Power Transmission Limited

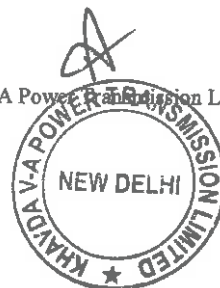
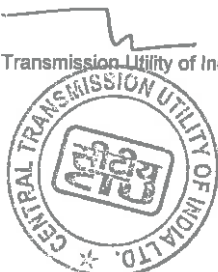

58

AND WHEREAS:

- A) In accordance with the Bidding Guidelines, the Bid Process Coordinator (hereinafter referred to as BPC) had initiated a competitive e-reverse bidding process through issue of RFP for selecting a Successful Bidder to build, own, operate and transfer the Project comprising of the Elements mentioned in Schedule 1 (hereinafter referred to as the Project)
- B) Pursuant to the said e-reverse bidding process, the BPC has identified the Successful Bidder, who will be responsible to set up the Project on build, own, operate and transfer basis to provide Transmission Service in accordance with the terms of this Agreement and the Transmission License.
- C) The Selected Bidder have submitted the Contract Performance Guarantee and acquired one hundred percent (100%) of the equity shareholding of Khavda V-A Power Transmission Limited, along with all its related assets and liabilities in terms of the provisions of the Share Purchase Agreement.
- D) The TSP has agreed to make an application for a Transmission License to the Commission for setting up the Project on build, own, operate and transfer basis.
- E) The TSP has further agreed to make an application to the Commission for the adoption of the Transmission Charges under Section 63 of the Electricity Act, 2003, along with a certification from the Bid Evaluation Committee in accordance with the Bidding Guidelines issued by Ministry of Power, Government of India.
- F) The TSP has agreed to execute the agreement(s) required, if any, under Sharing Regulations within fifteen (15) days from the date of grant of Transmission License from the Commission.
- G) The TSP agrees to the terms and conditions laid down under Sharing Regulations, for making available the ISTS and charge the Transmission Charges in accordance with the terms and conditions of Sharing Regulations.
- H) The billing, collection and disbursement of the Transmission Charges by the CTU to the ISTS Licensee shall be governed as per Sharing Regulations.
- I) The terms and conditions stipulated in the Transmission License issued by the Commission to the TSP shall be applicable to this Agreement and the TSP agrees to comply with these terms and conditions. In case of inconsistency between the Transmission License terms & conditions and the conditions of this Agreement, the conditions stipulated in the Transmission License granted by the Commission shall prevail.



Transmission Service Agreement

NOW, THEREFORE, IN CONSIDERATION OF THE PREMISES AND MUTUAL AGREEMENTS, COVENANTS AND CONDITIONS SET FORTH HEREIN, IT IS HEREBY AGREED BY AND BETWEEN THE PARTIES HERETO AS FOLLOWS:

Central Transmission Utility of India Limited



5

Khayda V-A Power Transmission Limited

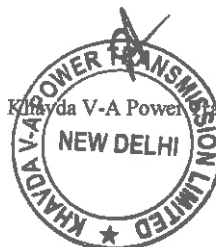

ARTICLE: 1

1 Definitions and Interpretations

1.1 Definitions:

1.1.1 The words / expressions used in this Agreement, unless as defined below or repugnant to the context, shall have the same meaning as assigned to them by the Electricity Act, 2003 and the rules or regulations framed there under including those issued / framed by the Commission (as defined hereunder), as amended or re-enacted from time to time or the General Clauses Act, failing which it shall bear its ordinary English meaning.

The words/expressions when used in this Agreement shall have the respective meanings as specified below:

“Acquisition Price” shall have the same meaning as defined in the Share Purchase Agreement;

“Act” or “Electricity Act” or “Electricity Act 2003” shall mean the Electricity Act, 2003 and any amendments made to the same or any succeeding enactment thereof;

“Affiliate” shall mean a company that either directly or indirectly

- i. controls or
- ii. is controlled by or
- iii. is under common control with

a Bidding Company (in the case of a single company) or a Member (in the case of a Consortium) and “control” means ownership by one entity of at least twenty six percent (26%) of the voting rights of the other entity;

“Availability” in relation to the Project or in relation to any Element of the Project, for a given period shall mean the time in hours during that period the Project is capable to transmit electricity at its Rated Voltage and shall be expressed in percentage of total hours in the given period and shall be calculated as per the procedure contained in Appendix –IV to Central Electricity Regulatory Commission (Terms and Conditions of Tariff) Regulations, 2024, attached herewith in Schedule 6;

“Bid” shall mean technical bid and financial bid submitted by the Bidder, in response to the RFP, in accordance with the terms and conditions of the RFP;

“Bid Deadline” shall mean the last date and time for submission of the Bid in response to RFP, as specified in the RFP;

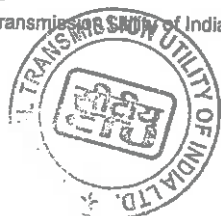

“**Bidding Company**” shall refer to such single company that has made a Response to RFP for the Project;

“**Bidding Consortium / Consortium**” shall refer to a group of companies that has collectively made a Response to RFP for the Project;

“**Bid Documents**” or “**Bidding Documents**” shall mean the RFP, along with all attachments thereto or clarifications thereof;

“**Bidding Guidelines**” shall mean the “Tariff Based Competitive Bidding Guidelines for Transmission Service” and “Guidelines for Encouraging Competition in Development of Transmission Projects” issued by Government of India, Ministry of Power under Section – 63 of the Electricity Act as amended from time to time;

“**Bid Process Coordinator**” or “**BPC**” shall mean a person or its authorized representative as notified by the Government of India, responsible for carrying out the process for selection of Bidder who will acquire Transmission Service Provider;

“**Bill**” shall mean any bill raised by the CTU on the DICs to recover the Transmission Charges pursuant to the Sharing Regulations;

“**Business Day**” shall mean a day other than Sunday or a statutory holiday, on which the banks remain open for business in the State in which the Nodal Agency’s registered office is located and the concerned TSP are located;

“**CEA**” shall mean the Central Electricity Authority constituted under Section - 70 of the Electricity Act;

“**Change in law**” shall have the meaning ascribed thereto in Article 12;

“**Commercial Operation Date**” or “**COD**” shall mean the date as per Article 6.2;

“**Commission**” or “**CERC**” shall mean the Central Electricity Regulatory Commission referred to in sub-section (1) of Section 76 of the Electricity Act, 2003 or its successors and assigns;

“**Competent Court of Law**” shall mean the Supreme Court or any High Court, or any tribunal or any similar judicial or quasi-judicial body in India that has jurisdiction to adjudicate upon issues relating to the Project;

“**Connection Agreement**” shall mean the agreement between the CTU or STU or any other concerned parties and the TSP, setting out the terms relating to the



connection of the Project to the Inter-connection Facilities and use of the Inter State Transmission System as per the provisions of the IEGC, as the case may be;

“Consultation Period” shall mean the period of sixty (60) days or such longer period as the Parties may agree, commencing from the date of issue of a TSP’s Preliminary Notice or a Nodal Agency’s Preliminary Termination Notice, as provided in Article 13 of this Agreement, for consultation between the Parties to mitigate the consequence of the relevant event having regard to all the circumstances;

“Consents, Clearances and Permits” shall mean all authorizations, licenses, approvals, registrations, permits, waivers, privileges, acknowledgements, agreements, or concessions required to be obtained from or provided by any concerned authority for the development, execution and operation of Project including without any limitation for the construction, ownership, operation and maintenance of the Transmission Lines and/or sub-stations;

“Construction Period” shall mean the period from (and including) the Effective Date of the Transmission Service Agreement up to (but not including) the COD of the Element of the Project in relation to an Element and up to (but not including) the COD of the Project in relation to the Project;

“Contractors” shall mean the engineering, procurement, construction, operation & maintenance contractors, surveyors, advisors, consultants, designers, suppliers to the TSP and each of their respective sub-contractors (and each of their respective successors and permitted assigns) in their respective capacities as such;

“Contract Performance Guarantee” shall mean the irrevocable unconditional bank guarantee, submitted and to be submitted by the TSP or by the Selected Bidder on behalf of the TSP to the Nodal Agency from a bank mentioned in Annexure 17 of the RFP, in the form attached here to as Schedule 8, in accordance with Article 3 of this Agreement and which shall include the additional bank guarantee furnished by the TSP under this Agreement;

“Contract Year”, for the purpose of payment of Transmission Charges, shall mean the period beginning on the COD, and ending on the immediately succeeding March 31 and thereafter each period of 12 months beginning on April 1 and ending on March 31 provided that the last Contract Year shall end on the last day of the term of the TSA;

“CTU” or “Central Transmission Utility” shall have same meaning as defined in the Electricity Act, 2003;

“Day” shall mean a day starting at 0000 hours and ending at 2400 hours;

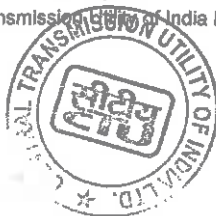

“D/C” shall mean Double Circuit;

“Designated ISTS Customers” or “DICs” shall have the meaning as ascribed in the Sharing Regulations;

“Dispute” shall mean any dispute or difference of any kind between the Parties, in connection with or arising out of this Agreement including any issue on the interpretation and scope of the terms of this Agreement as provided in Article 16;

“Effective Date” for the purposes of this Agreement, shall have the same meaning as per Article 2.1 of this Agreement;

“Electrical Inspector” shall mean a person appointed as such by the Government under sub-section (1) of Section 162 of the Electricity Act 2003 and also includes Chief Electrical Inspector;

“Electricity Rules 2005” shall mean the rules framed pursuant to the Electricity Act 2003 and as amended from time to time;

“Element” shall mean each Transmission Line or each circuit of the Transmission Lines (where there are more than one circuit) or each bay of Sub-station or switching station or HVDC terminal or inverter station of the Project, including ICTs, Reactors, SVC, FSC, etc. forming part of the ISTS, which will be owned, operated and maintained by the concerned ISTS Licensee, and which has a separate Scheduled COD as per Schedule 2 of this Agreement and has a separate percentage for recovery of Transmission Charges on achieving COD as per Schedule 5 of this Agreement;

“Event of Default” shall mean the events as defined in Article 13 of this Agreement;

“Expiry Date” shall be the date which is thirty-five (35) years from the COD of the Project;

“Financial Closure” shall mean the first Business Day on which funds are made available to the TSP pursuant to the Financing Agreements;

“Financially Evaluated Entity” shall mean the company which has been evaluated for the satisfaction of the financial requirement set forth in the RFP;

“Financing Agreements” shall mean the agreements pursuant to which the TSP is to finance the Project including the loan agreements, security documents, notes, indentures, security agreements, letters of credit and other documents, as may be amended, modified, or replaced from time to time, but without in anyway increasing the liabilities of the Designated ISTS Customers / Nodal Agency;



64



“Financial Year” shall mean a period of twelve months at midnight Indian Standard Time (IST) between 1st April & 31st March;

“Force Majeure” and **“Force Majeure Event”** shall have the meaning assigned thereto in Article 11;

“GOI” shall mean Government of India;

“Grid Code” / **“IEGC”** shall mean the Grid Code specified by the Central Commission under Clause (h) of sub-section (1) of Section 79 of the Electricity Act;

“Independent Engineer” shall mean an agency/ company, appointed by Nodal Agency in accordance with the Guidelines for Encouraging Competition in Development of Transmission Projects.

“Indian Governmental Instrumentality” shall mean Government of India, Government of any State in India or any ministry, department, board, authority, agency, corporation, commission under the direct or indirect control of Government of India or any State Government or both, any political sub-division of any of them including any court or Commission or tribunal or judicial or quasi-judicial body in India but excluding the CTU, TSP and the Designated ISTS Customers;

“Insurances” shall mean the insurance cover to be obtained and maintained by the TSP in accordance with Article 9 of this Agreement;

“Interconnection Facilities” shall mean the facilities as may be set up for transmission of electricity through the use of the Project, on either one or both side of generating station's / CTU's / STU's / ISTS Licensee's / Designated ISTS Customer's substations (as the case may be) which shall include, without limitation, all other transmission lines, gantries, sub-stations and associated equipment not forming part of the Project;

“ISTS Licensee” shall be the TSP under this Agreement, consequent to having been awarded a Transmission License by the CERC and shall be referred to as the TSP or the ISTS Licensee, as the context may require in this Agreement;

“Law” or **“Laws”** in relation to this Agreement, shall mean all laws including electricity laws in force in India and any statute, ordinance, rule, regulation, notification, order or code, or any interpretation of any of them by an Indian Governmental Instrumentality having force of law and shall include all rules, regulations, decisions and orders of the Commission;



65

“Lead Member of the Bidding Consortium” or “Lead Member” shall mean a company who commits at least 26% equity stake in the Project, meets the technical requirement as specified in the RFP and so designated by other Member(s) in Bidding Consortium;

“Lenders” means the banks, financial institutions, multilateral funding agencies, non-banking financial companies registered with the Reserve Bank of India (RBI), insurance companies registered with the Insurance Regulatory & Development Authority (IRDA), pension funds regulated by the Pension Fund Regulatory & Development Authority (PFRDA), mutual funds registered with Securities & Exchange Board of India (SEBI), etc., including their successors and assigns, who have agreed on or before COD of the Project to provide the TSP with the debt financing described in the capital structure schedule, and any successor banks or financial institutions to whom their interests under the Financing Agreements may be transferred or assigned;

Provided that, such assignment or transfer shall not relieve the TSP of its obligations to the Nodal Agency under this Agreement in any manner and shall also does not lead to an increase in the liability of the Nodal Agency;

“Lenders Representative” shall mean the person notified by the Lender(s) in writing as being the representative of the Lender(s) or the Security Trustee and such person may from time to time be replaced by the Lender(s) pursuant to the Financing Agreements by written notice to the TSP;

“Letter of Intent” or “LOI” shall have the same meaning as in the RFP;

“Member in a Bidding Consortium / Member” shall mean each company in the Bidding Consortium;

“Month” shall mean a period of thirty (30) days from (and excluding) the date of the event;

“Monthly Transmission Charges” for any Element of the Project, after COD of the Element till COD of the Project, and for the Project after COD of the Project, shall mean the amount of Transmission Charges as specified in Schedule 5 of this Agreement multiplied by no. of days in the relevant month and divided by no. of days in the year;

“National Load Despatch Centre” shall mean the centre established as per sub-section (1) of Section 26 of the Electricity Act 2003;

“Nodal Agency” shall mean CTU, which shall execute and implement the Transmission Service Agreement (TSA);

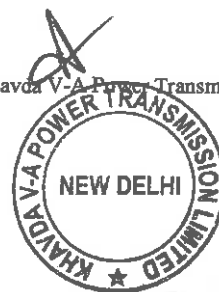

Provided that while taking major decisions, CTU shall consult CEA on technical matters and any other matter it feels necessary.

"Notification" shall mean any notification, issued in the Gazette of India;

"Operating Period" for any Element of the Project shall mean the period from (and including) the COD of such Element of the Project, up to (and including) the Expiry Date and for the Project, shall mean the period from (and including) the COD of the Project, up to (and including) the Expiry Date;

"Parent Company" shall mean an entity that holds at least twenty-six percent (26%) of the paid - up equity capital directly or indirectly in the Bidding Company or in the Member in a Bidding Consortium, as the case may be;

"Preliminary Termination Notice" shall mean a Nodal Agency's Preliminary Termination Notice as defined in Article 13 of this Agreement;

"Project" shall mean Transmission system for Evacuation of Power from potential renewable energy zone in Khavda area of Gujarat under Phase-V (8 GW): Part A, as detailed in Schedule 1 of this Agreement;

"Project Assets" shall mean all physical and other assets relating to and forming part of the Project including:

- (a) rights over the Site for substations, ROW for transmission lines;
- (b) tangible & intangible assets such as civil works and equipment including foundations, embankments, pavements, electrical systems, communication systems, relief centres, administrative offices, Sub-stations, software, tower and sub-stations designs etc;
- (c) project facilities situated on the Site;
- (d) all rights of the TSP under the project agreements;
- (e) financial assets, such as receivables, security deposits etc;
- (f) insurance proceeds; and
- (g) Applicable Permits and authorisations relating to or in respect of the Transmission System;"

"Project Execution Plan" shall mean the plan referred to in Article 3.1.3(c) hereof;

"Prudent Utility Practices" shall mean the practices, methods and standards that are generally accepted internationally from time to time by electric



transmission utilities for the purpose of ensuring the safe, efficient and economic design, construction, commissioning, operation, repair and maintenance of the Project and which practices, methods and standards shall be adjusted as necessary, to take account of:

- (i) operation, repair and maintenance guidelines given by the manufacturers to be incorporated in the Project,
- (ii) the requirements of Law, and
- (iii) the physical conditions at the Site;
- (iv) the safety of operating personnel and human beings;

“Rated Voltage” shall mean voltage at which the Transmission System is designed to operate or such lower voltage at which the line is charged, for the time being, in consultation with the Central Transmission Utility;

“Rebate” shall have the meaning as ascribed to in Article 10.3 of this Agreement;

“RFP” shall mean Request for Proposal dated 04.12.2023 along with all schedules, annexures and RFP Project Documents attached thereto, issued by the BPC for tariff based competitive bidding process for selection of Bidder as TSP to execute the Project, including any modifications, amendments or alterations thereto;

“RFP Project Documents” shall mean the following documents to be entered into in respect of the Project, by the Parties to the respective agreements:

- a. Transmission Service Agreement,
- b. Share Purchase Agreement,
- c. Agreement(s) required under Sharing Regulations and
- d. Any other agreement as may be required;

“RLDC” shall mean the relevant Regional Load Dispatch Centre as defined in the Electricity Act, 2003, in the region(s) in which the Project is located;

“RPC” shall mean the relevant Regional Power Committee established by the Government of India for the specific Region(s) in accordance with the Electricity Act, 2003 for facilitating integrated operation of the Power System in that Region;



"Scheduled COD" in relation to an Element(s) shall mean the date(s) as mentioned in Schedule 2 as against such Element(s) and in relation to the Project, shall mean the date as mentioned in Schedule 2 as against such Project, subject to the provisions of Article 4.4 of this Agreement, or such date as may be mutually agreed among the Parties;

"Scheduled Outage" shall mean the final outage plan as approved by the RPC as per the provisions of the Grid Code;

"Selected Bid" shall mean the technical Bid and the Final Offer of the Selected Bidder submitted during e-reverse bidding, which shall be downloaded and attached in Schedule 7 on or prior to the Effective Date;

"Share Purchase Agreement" shall mean the agreement amongst REC Power Development and Consultancy Limited, Khavda V-A Power Transmission Limited and the Successful Bidder for the purchase of one hundred (100%) per cent of the shareholding of the Khavda V-A Power Transmission Limited for the Acquisition Price, by the Successful Bidder on the terms and conditions as contained therein;

"Sharing Regulations" shall mean the Central Electricity Regulatory Commission (Sharing of Inter-State Transmission Charges and Losses) Regulations, 2020 and as amended from time to time;

"Site" in relation to a substation, switching station or HVDC terminal or inverter station, shall mean the land and other places upon which such station / terminal is to be established;

"SLDC" shall mean the State Load Despatch Centre established as per sub-section (1) of Section 31 of the Electricity Act 2003;

"STU" or **"State Transmission Utility"** shall be the Board or the Government company, specified as such by the State Government under sub-section (1) of Section 39 of the Electricity Act 2003;

"Successful Bidder" or **"Selected Bidder"** shall mean the Bidder selected pursuant to the RFP and who has to acquire one hundred percent (100%) equity shares of Khavda V-A Power Transmission Limited, along with all its related assets and liabilities, which will be responsible as the TSP to establish the Project on build, own, operate and transfer basis as per the terms of the TSA and other RFP Project Documents;

"TSP's Preliminary Notice" shall mean a notice issued by the TSP in pursuant to the provisions of Article 13.3 of this Agreement;

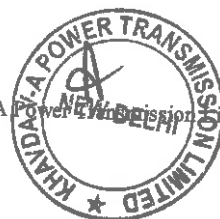

“Target Availability” shall have the meaning as ascribed hereto in Article 8.2 of this Agreement;

“Technically Evaluated Entity” shall mean the company which has been evaluated for the satisfaction of the technical requirement set forth in RFP;

“Termination Notice” shall mean a Nodal Agency’s Termination Notice given by the Nodal Agency to the TSP pursuant to the provisions of Articles 3.3.2, 3.3.4, 4.4.2, 5.8, 13.2 and 13.3 of this Agreement for the termination of this Agreement;

“Term of Agreement” for the purposes of this Agreement shall have the meaning ascribed thereto in Article 2.2 of this Agreement;

“Transmission Charges” shall mean the Final Offer of the Selected Bidder during the e-reverse bidding and adopted by the Commission, payable to the TSP as per Sharing Regulations;

“Transmission License” shall mean the license granted by the Commission in terms of the relevant regulations for grant of such license issued under the Electricity Act;

“Transmission Service” shall mean making the Project available as per the terms and conditions of this Agreement and Sharing Regulations;

“Unscheduled Outage” shall mean an interruption resulting in reduction of the Availability of the Element(s) / Project (as the case may be) that is not a result of a Scheduled Outage or a Force Majeure Event.

“Ultimate Parent Company” shall mean an entity which owns at least twenty six percent (26%) equity in the Bidding Company or Member of a Consortium, (as the case may be) and in the Technically Evaluated Entity and / or Financially Evaluated Entity (as the case may be) and such Bidding Company or Member of a Consortium, (as the case may be) and the Technically Evaluated Entity and / or Financially Evaluated Entity (as the case may be) shall be under the direct control or indirectly under the common control of such entity;

1.2 Interpretation:

Save where the contrary is indicated, any reference in this Agreement to:

“Agreement” shall be construed as including a reference to its Schedules, Appendices and Annexures;

“Rupee”, “Rupees” and “Rs.” shall denote lawful currency of India;

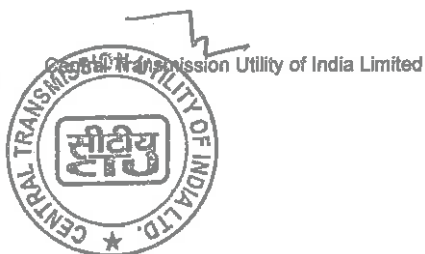

"crore" shall mean a reference to ten million (10,000,000) and a "lakh" shall mean a reference to one tenth of a million (1,00,000);

"encumbrance" shall be construed as a reference to a mortgage, charge, pledge, lien or other encumbrance securing any obligation of any person or any other type of preferential arrangement (including, without limitation, title transfer and retention arrangements) having a similar effect;

"holding company" of a company or corporation shall be construed as a reference to any company or corporation of which the other company or corporation is a subsidiary;

"indebtedness" shall be construed so as to include any obligation (whether incurred as principal or surety) for the payment or repayment of money, whether present or future, actual or contingent;

"person" shall have the meaning as defined in Section 2 (49) of the Act;

"subsidiary" of a company or corporation (the holding company) shall be construed as a reference to any company or corporation:

- (i) which is controlled, directly or indirectly, by the holding company, or
- (ii) more than half of the issued share capital of which is beneficially owned, directly or indirectly, by the holding company, or
- (iii) which is a subsidiary of another subsidiary of the holding company,

for these purposes, a company or corporation shall be treated as being controlled by another if that other company or corporation is able to direct its affairs and/or to control the composition of its board of directors or equivalent body;

"winding-up", "dissolution", "insolvency", or "reorganization" in the context of a company or corporation shall have the same meaning as defined in the Companies Act, 1956/ Companies Act, 2013 (as the case may be).

1.2.1 Words importing the singular shall include the plural and vice versa.

1.2.2 This Agreement itself or any other agreement or document shall be construed as a reference to this or to such other agreement or document as it may have been, or may from time to time be, amended, varied, novated, replaced or supplemented.

1.2.3 A Law shall be construed as a reference to such Law including its amendments or re-enactments from time to time.



Transmission Service Agreement

- 1.2.4 A time of day shall, save as otherwise provided in any agreement or document be construed as a reference to Indian Standard Time.
- 1.2.5 Different parts of this Agreement are to be taken as mutually explanatory and supplementary to each other and if there is any inconsistency between or among the parts of this Agreement, they shall be interpreted in a harmonious manner so as to give effect to each part.
- 1.2.6 The tables of contents and any headings or sub-headings in this Agreement have been inserted for ease of reference only and shall not affect the interpretation of this Agreement.
- 1.2.7 All interest payable under this Agreement shall accrue from day to day and be calculated on the basis of a year of three hundred and sixty-five (365) days.
- 1.2.8 The words "hereof" or "herein", if and when used in this Agreement shall mean a reference to this Agreement.
- 1.2.9 The contents of Schedule 7 shall be referred to for ascertaining accuracy and correctness of the representations made by the Selected Bidder in Article 17.2.1 hereof.

Central Transmission Utility of India Limited



17

72

Khavda V-A Power Transmission Limited



ARTICLE: 2

2 Effectiveness and Term of Agreement

2.1 Effective Date:

This Agreement shall be effective from later of the dates of the following events:

- a. The Selected Bidder, on behalf of the TSP, has provided the Contract Performance Guarantee, as per terms of Article 3.1 of this Agreement; and
- b. The Selected Bidder has acquired for the Acquisition Price, one hundred percent (100%) of the equity shareholding of REC Power Development and Consultancy Limited in Khavda V-A Power Transmission Limited along with all its related assets and liabilities as per the provisions of the Share Purchase Agreement. and
- c. The Agreement is executed and delivered by the Parties;

2.2 Term and Termination:

2.2.1 Subject to Article 2.2.3 and Article 2.4, this Agreement shall continue to be effective in relation to the Project until the Expiry Date, when it shall automatically terminate.

2.2.2 Post the Expiry Date of this Agreement, the TSP shall ensure transfer of Project Assets to CTU or its successors or an agency as decided by the Central Government at zero cost and free from any encumbrance and liability. The transfer shall be completed within 90 days of expiry of this Agreement failing which CTU shall be entitled to take over the Project Assets Suo moto.

2.2.3 This Agreement shall terminate before the Expiry Date in accordance with Article 13 or Article 3.3.2 or Article 3.3.4.

2.3 Conditions prior to the expiry of the Transmission License

2.3.1 In order to continue the Project beyond the expiry of the Transmission License, the TSP shall be obligated to make an application to the Commission at least two (2) years before the date of expiry of the Transmission License, seeking the Commission's approval for the extension of the term of the Transmission License up to the Expiry Date.

Central Transmission Utility of India Limited



18

Khavda V-A Power Transmission Limited

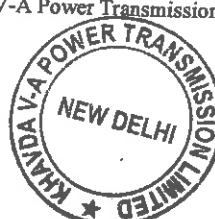

73

2.3.2 The TSP shall timely comply with all the requirements that may be laid down by the Commission for extension of the term of the Transmission License beyond the initial term of twenty-five (25) years & upto the Expiry Date and the TSP shall keep the Nodal Agency fully informed about the progress on its application for extension of the term of the Transmission License.

2.4 Survival:

The expiry or termination of this Agreement shall not affect any accrued rights, obligations/ roles and liabilities of the Parties under this Agreement, including the right to receive liquidated damages as per the terms of this Agreement, nor shall it effect the survival of any continuing obligations/ roles for which this Agreement provides, either expressly or by necessary implication, which are to survive after the Expiry Date or termination including those under Articles 3.3.3, 3.3.5, Article 9.3 (Application of Insurance Proceeds), Article 11 (Force Majeure), Article 13 (Events of Default and Termination), Article 14 (Liability & Indemnification), Article 16 (Governing Law & Dispute Resolution), Article 19 (Miscellaneous).

2.5 Applicability of the provisions of this Agreement

2.5.1 For the purpose of Availability, Target Availability and the computation of Availability, Incentive, Penalty, the provisions provided in this Agreement shall apply and any future modifications in the relevant Rules and Regulations shall not be applicable for this Project.

2.5.2 For the purposes of this Agreement for ISTS systems developed under the tariff based competitive bidding framework, the provisions relating to the definitions (Availability and COD), Article 3 (Contract Performance Guarantee and Conditions Subsequent), Article 5 (Construction of the Project), Article 6 (Connection and Commissioning of the Project), Article 8 (Target Availability and calculation of Availability), Article 11 (Force Majeure), Article 12 (Change in Law), Article 13 (Event of Default), Article 14 (Indemnification), Article 15 (Assignment and Charges), Articles 16.1, 16.2 and 16.4 (Governing Laws and Dispute Resolution) and Article 17 (representation and warranties of the ISTS Licensee) of this agreement shall supersede the corresponding provisions under Sharing Regulations.

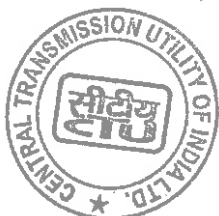

ARTICLE: 3

3 Conditions Subsequent

3.1 Satisfaction of conditions subsequent by the TSP

3.1.1 Within ten (10) days from the date of issue of Letter of Intent, the Selected Bidder, shall:

- a. Provide the Contract Performance Guarantee, and
- b. Acquire, for the Acquisition Price, one hundred percent (100%) equity shareholding of Khavda V-A Power Transmission Limited from REC Power Development and Consultancy Limited, who shall sell to the Selected Bidder, the equity shareholding of Khavda V-A Power Transmission Limited, along with all its related assets and liabilities.

c. Execute this Agreement;

The TSP shall, within five (5) working days from the date of acquisition of SPV by the Selected Bidder, undertake to apply to the Commission for the grant of Transmission License and for the adoption of tariff as required under section-63 of the Electricity Act.

The Selected Bidder, on behalf of the TSP, will provide to the Central Transmission Utility of India Limited (being the Nodal Agency) the **Contract Performance Guarantee for an amount of Rs. 714.00 Crore (Rupees Seven Hundred Fourteen Crore only)**.

3.1.2 The Contract Performance Guarantee shall be initially valid for a period up to three (3) months after the Scheduled COD of the Project and shall be extended from time to time to be valid for a period up to three (3) months after the COD of the Project. In case the validity of the Contract Performance Guarantee is expiring before the validity specified in this Article, the TSP shall, at least thirty (30) days before the expiry of the Contract Performance Guarantee, replace the Contract Performance Guarantee with another Contract Performance Guarantee or extend the validity of the existing Contract Performance Guarantee until the validity period specified in this Article.

3.1.3 The TSP agrees and undertakes to duly perform and complete the following activities within six (6) months from the Effective Date (except for c) below), unless such completion is affected due to any Force Majeure Event, or if any of the activities is specifically waived in writing by the Nodal Agency:

- a. To obtain the Transmission License for the Project from the Commission;

Central Transmission Utility of India Limited

20

Khavda V-A Power Transmission Limited



75

- b. To obtain the order for adoption of Transmission Charges by the Commission, as required under Section 63 of the Electricity Act 2003;
- c. To submit to the Nodal Agency, CEA & Independent Engineer, the Project Execution Plan, immediately after award of contract(s) and maximum within one hundred and twenty (120) days from the Effective Date. Also, an approved copy each of Manufacturing Quality Plan (MQP) and Field Quality Plan (FQP) would be submitted to Independent Engineer & Nodal Agency in the same time period. The TSP's Project Execution Plan should be in conformity with the Scheduled COD as specified in Schedule 2 of this Agreement, and shall bring out clearly the organization structure, time plan and methodology for executing the Project, award of major contracts, designing, engineering, procurement, shipping, construction, testing and commissioning to commercial operation;
- d. To submit to the Nodal Agency, CEA & Independent Engineer a detailed bar (GANTT) chart of the Project outlining each activity (taking longer than one Month), linkages as well as durations;
- e. To submit to the Nodal Agency, CEA & Independent Engineer detailed specifications of conductor meeting the functional specifications specified in RFP;
- f. To achieve Financial Closure;
- g. To provide an irrevocable letter to the Lenders duly accepting and acknowledging the rights provided to the Lenders under the provisions of Article 15.3 of this Agreement and all other RFP Project Documents;
- h. To award the Engineering, Procurement and Construction contract ("EPC contract") for the design and construction of the Project and shall have given to such Contractor an irrevocable notice to proceed; and
- i. To sign the Agreement(s) required, if any, under Sharing Regulations.

3.2 Recognition of Lenders' Rights by the Nodal Agency

3.2.1 The Nodal Agency hereby accepts and acknowledges the rights provided to the Lenders as per Article 15.3 of this Agreement and all other RFP Project Documents.

3.3 Consequences of non-fulfilment of conditions subsequent

3.3.1 If any of the conditions specified in Article 3.1.3 is not duly fulfilled by the TSP even within three (3) Months after the time specified therein, then on and from

Central Transmission Utility of India Limited

21

Khavda V-A Power Transmission Limited

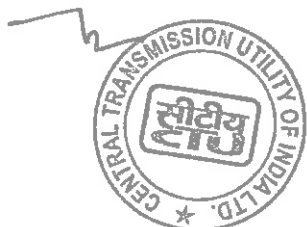

94



76

the expiry of such period and until the TSP has satisfied all the conditions specified in Article 3.1.3, the TSP shall, on a monthly basis, be liable to furnish to Central Transmission Utility of India Limited (being the Nodal Agency) additional Contract Performance Guarantee of Rupees Seventy One Crore and Forty Lakh Only (Rs. 71.40 Crore) within two (2) Business Days of expiry of every such Month. Such additional Contract Performance Guarantee shall be provided to Central Transmission Utility of India Limited (being the Nodal Agency) in the manner provided in Article 3.1.1 and shall become part of the Contract Performance Guarantee and all the provisions of this Agreement shall be construed accordingly. Central Transmission Utility of India Limited (being the Nodal Agency) shall be entitled to hold and / or invoke the Contract Performance Guarantee, including such additional Contract Performance Guarantee, in accordance with the provisions of this Agreement.

3.3.2 Subject to Article 3.3.4, if:

- (i) the fulfilment of any of the conditions specified in Article 3.1.3 is delayed beyond nine (9) Months from the Effective Date and the TSP fails to furnish additional Contract Performance Guarantee to the Nodal Agency in accordance with Article 3.3.1 hereof; or
- (ii) the TSP furnishes additional Performance Guarantee to the Nodal Agency in accordance with Article 3.3.1 hereof but fails to fulfil the conditions specified in Article 3.1.3 within a period of twelve (12) months from the Effective Date,

the Nodal Agency shall have the right to terminate this Agreement, by giving a Termination Notice to the TSP, in writing, of at least seven (7) days, with a copy to CEA and the Lenders' Representative in order to enable the Lenders to exercise right of substitution in accordance with Article 15.3 of this Agreement.

3.3.3 If the Nodal Agency elects to terminate this Agreement as per the provisions of Article 3.3.2, the TSP shall be liable to pay to the Nodal Agency an amount of Rs. 714.00 Crore (Rupees Seven Hundred Fourteen Crore only) as liquidated damages. The Nodal Agency shall be entitled to recover this amount of damages by invoking the Contract Performance Guarantee to the extent of liquidated damages, which shall be required by the Nodal Agency, and the balance shall be returned to TSP, if any.

It is clarified for removal of doubt that this Article shall survive the termination of this Agreement.

3.3.4 In case of inability of the TSP to fulfil the conditions specified in Article 3.1.3

Central Transmission Utility of India Limited

22

Khayda V.A Power Transmission Limited



77

due to any Force Majeure Event, the time period for fulfilment of the condition subsequent as mentioned in Article 3.1.3, may be extended for a period of such Force Majeure Event. Alternatively, if deemed necessary, this Agreement may be terminated by the Nodal Agency by giving a Termination Notice to the TSP, in writing, of at least seven (7) days, with a copy to CEA and the Lenders' Representative in order to enable the Lenders to exercise right of substitution in accordance with Article 15.3 of this Agreement and the Contract Performance Guarantee shall be returned as per the provisions of Article 6.5.1.

Provided, that due to the provisions of this Article 3.3.4, any increase in the time period for completion of conditions subsequent mentioned under Article 3.1.3, shall lead to an equal increase in the time period for the Scheduled COD. If the Scheduled COD is extended beyond a period of one hundred eighty (180) days due to the provisions of this Article 3.3.4, the TSP will be allowed to recover the interest cost during construction corresponding to the period exceeding one hundred eighty (180) days by adjustment in the Transmission Charges in accordance with Schedule 9.

3.3.5 Upon termination of this Agreement as per Articles 3.3.2 and 3.3.4, the Nodal Agency may take steps to bid out the Project again.

3.3.6 The Nodal agency, on the failure of the TSP to fulfil its obligations, if it considers that there are sufficient grounds for so doing, apart from invoking the Contract Performance Guarantee under para 3.3.3 may also initiate proceedings for blacklisting the TSP as per provisions of Article 13.2 of TSA.

3.4 Progress Reports

The TSP shall notify the Nodal Agency and CEA in writing at least once a Month on the progress made in satisfying the conditions subsequent in Articles 3.1.3.



ARTICLE: 4

4 Development of the Project

4.1 TSP's obligations in development of the Project:

Subject to the terms and conditions of this Agreement, the TSP at its own cost and expense shall observe, comply with, perform, undertake and be responsible:

- a. for procuring and maintaining in full force and effect all Consents, Clearances and Permits, required in accordance with Law for development of the Project;
- b. for financing, constructing, owning and commissioning each of the Element of the Project for the scope of work set out in Schedule 1 of this Agreement in accordance with:
 - i. the Electricity Act and the Rules made thereof;
 - ii. the Grid Code;
 - iii. the CEA Regulations applicable, and as amended from time to time, for Transmission Lines and sub-stations:
 - the Central Electricity Authority (Technical Standards for Connectivity to the Grid) Regulations, 2007;
 - Central Electricity Authority (Technical Standards for construction of Electrical Plants and Electric Lines) Regulation, 2010;
 - Central Electricity Authority (Grid Standard) Regulations, 2010;
 - Central Electricity Authority (Safety requirements for construction, operation and maintenance of Electrical Plants and Electrical Lines) Regulation, 2011;
 - Central Electricity Authority (Measures relating to Safety and Electricity Supply) Regulation, 2010;
 - Central Electricity Authority (Technical Standards for Communication System in Power System Operation) Regulations, 2020.
 - iv. Safety/ security Guidelines laid down by the Government;
 - v. Prudent Utility Practices, relevant Indian Standards and the Law;

Central Transmission Utility of India Limited



Khavda V-A Power Transmission Limited



Transmission Service Agreement

not later than the Scheduled COD as per Schedule 2 of this Agreement;

- c. for entering into a Connection Agreement with the concerned parties in accordance with the Grid Code.
- d. for owning the Project throughout the term of this Agreement free and clear of any encumbrances except those expressly permitted under Article 15 of this Agreement;
- e. to co-ordinate and liaise with concerned agencies and provide on a timely basis relevant information with regard to the specifications of the Project that may be required for interconnecting the Project with the Interconnection Facilities;
- f. for providing all assistance to the Arbitrators as they may require for the performance of their duties and responsibilities;
- g. to provide to the Nodal Agency and CEA, on a monthly basis, progress reports with regard to the Project and its execution (in accordance with prescribed form) to enable the CEA to monitor and co-ordinate the development of the Project matching with the Interconnection Facilities;
- h. to comply with Ministry of Power order no. 25-11/6/2018 – PG dated 02.07.2020 as well as other Guidelines issued by Govt. of India pertaining to this;
- i. to procure the products associated with the Transmission System as per provisions of Public Procurement (Preference to Make in India) orders issued by Ministry of Power vide orders No. 11/5/2018 - Coord. dated 28.07.2020 for transmission sector, as amended from time to time read with Department for Promotion of Industry and Internal Trade (DPIIT) orders in this regard (Procuring Entity as defined in above orders shall deemed to have included Selected Bidder and/ or TSP)..

Also, to comply with Department of Expenditure, Ministry of Finance vide Order (Public Procurement No 1) bearing File No. 6/18/2019-PPD dated 23.07.2020, Order (Public Procurement No 2) bearing File No. 6/18/2019-PPD dated 23.07.2020 and Order (Public Procurement No. 3) bearing File No. 6/18/2019-PPD, dated 24.07.2020, as amended from time to time, regarding public procurement from a bidder of a country, which shares land border with India;

Central Transmission Utility of India Limited

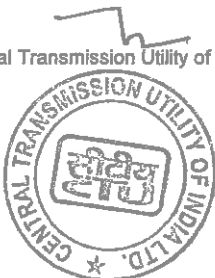

25

Khavda V-A Power Transmission Limited



Transmission Service Agreement

- j. to submit to Nodal Agency information in the prescribed format [To be devised by Nodal Agency] for ensuring compliance to Article 4.1 i) above.
- k. to comply with all its obligations undertaken in this Agreement.

4.2 Roles of the Nodal Agency in implementation of the Project:

4.2.1 Subject to the terms and conditions of this Agreement, the Nodal Agency shall be the holder and administrator of this Agreement and shall inter alia:

- a. appoint an Independent Engineer within 90 days of the Effective Date
- b. provide letters of recommendation to the concerned Indian Governmental Instrumentality, as may be requested by the TSP from time to time, for obtaining the Consents, Clearances and Permits required for the Project;
- c. coordinate among TSP and upstream/downstream entities in respect of Interconnection Facilities; and
- d. monitor the implementation of the Agreement and take appropriate action for breach thereof including revocation of guarantees, cancellation of Agreement, blacklisting etc
- e. provide all assistance to the Arbitrators as required for the performance of their duties and responsibilities; and
- f. perform any other responsibility (ies) as specified in this Agreement.

4.3 Time for Commencement and Completion:

- a. The TSP shall take all necessary steps to commence work on the Project from the Effective Date of the Agreement and shall achieve Scheduled COD of the Project in accordance with the time schedule specified in Schedule 2 of this Agreement;
- b. The COD of each Element of the Project shall occur no later than the Scheduled COD or within such extended time to which the TSP shall be entitled under Article 4.4 hereto.

4.4 Extension of time:

4.4.1 In the event that the TSP is unable to perform its obligations for the reasons solely attributable to the Nodal Agency, the Scheduled COD shall be extended, by a 'day to day' basis, subject to the provisions of Article 13.



Transmission Service Agreement

- 4.4.2 In the event that an Element or the Project cannot be commissioned by its Scheduled COD on account of any Force Majeure Event as per Article 11, the Scheduled COD shall be extended, by a 'day to day' basis for a period of such Force Majeure Event. Alternatively, if deemed necessary, the Nodal Agency may terminate the Agreement as per the provisions of Article 13.4 by giving a Termination Notice to the TSP, in writing, of at least seven (7) days, with a copy to CEA and the Lenders' Representative in order to enable the Lenders to exercise right of substitution in accordance with Article 15.3 of this Agreement.
- 4.4.3 If the Parties have not agreed, within thirty (30) days after the affected Party's performance has ceased to be affected by the relevant circumstance, on how long the Scheduled COD should be deferred by, any Party may raise the Dispute to be resolved in accordance with Article 16.
- 4.5 Metering Arrangements:**
- 4.5.1 The TSP shall comply with all the provisions of the IEGC and the Central Electricity Authority (Installation and Operation of Meters) Regulations, 2006 as amended from time to time, with regard to the metering arrangements for the Project. The TSP shall fully cooperate with the CTU / STU / RLDC and extend all necessary assistance in taking meter readings.
- 4.6 Interconnection Facilities:**
- 4.6.1 Subject to the terms and conditions of this Agreement, the TSP shall be responsible for connecting the Project with the interconnection point(s) specified in Schedule 1 of this Agreement. The Interconnection Facilities shall be developed as per the scope of work and responsibilities assigned in Schedule 1 of this Agreement. The Nodal Agency shall be responsible for coordinating to make available the Interconnection Facilities.
- 4.6.2 In order to remove any doubts, it is made clear that the obligation of the TSP within the scope of the project is to construct the Project as per Schedule-1 of this Agreement and in particular to connect it to the Interconnection Facilities as specified in this Agreement.

Central Transmission Utility of India Limited

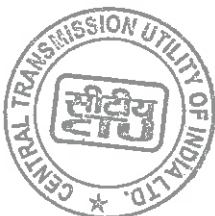

27

Khavda V-A Power Transmission Limited



82



ARTICLE: 5

5 Construction of the Project

5.1 TSP's Construction Responsibilities:

- 5.1.1 The TSP, at its own cost and expense, shall be responsible for designing, constructing, erecting, testing and commissioning each Element of the Project by the Scheduled COD in accordance with the Regulations and other applicable Laws specified in Article 4.1 of this Agreement.
- 5.1.2 The TSP acknowledges and agrees that it shall not be relieved from any of its obligations under this Agreement or be entitled to any extension of time or any compensation whatsoever by reason of the unsuitability of the Site or Transmission Line route(s).
- 5.1.3 The TSP shall be responsible for obtaining all Consents, Clearances and Permits related but not limited to road / rail / river / canal / power line / crossings, Power and Telecom Coordination Committee (PTCC), defence, civil aviation, right of way / way-leaves and environmental & forest clearances from relevant authorities required for developing, financing, constructing, maintaining/ renewing all such Consents, Clearances and Permits in order to carry out its obligations under this Agreement in general and shall furnish to the Nodal Agency such copy/ies of each Consents, Clearances and Permits, on demand. Nodal Agency shall provide letters of recommendation to the concerned Indian Governmental Instrumentality, as may be requested by the TSP from time to time, for obtaining the Consents, Clearances and Permits required for the Project.
- 5.1.4 The TSP shall be responsible for:
- (a) acquisition of land for location specific substations, switching stations or HVDC terminal or inverter stations. Also, the actual location of Greenfield substations (Switching Stations or HVDC Terminal or Inverter Stations) for a generation pooling substation and for load serving substations in the scope of TSP shall not be beyond 3 Km radius of the location proposed by the BPC in the survey report. However, actual location of any Greenfield Intermediate Substations in the scope of TSP shall not be beyond 10 Km radius of the location proposed by the BPC in the Survey Report.
 - (b) final selection of Site including its geo-technical investigation;
 - (c) survey and geo-technical investigation of line route in order to determine the final route of the Transmission Lines;

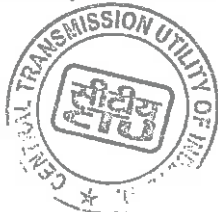

- (d) seeking access to the Site and other places where the Project is being executed, at its own risk and costs, including payment of any crop, tree compensation or any other compensation as may be required.

5.1.5 In case the Project involves any resettlement and rehabilitation, the resettlement and rehabilitation package will be implemented by the State Government authorities, for which the costs are to be borne by the TSP and no changes would be allowed in the Transmission Charges on account of any variation in the resettlement and rehabilitation cost. The TSP shall provide assistance on best endeavour basis, in implementation of the resettlement and rehabilitation package, if execution of such package is in the interest of expeditious implementation of the Project and is beneficial to the Project affected persons.

5.2 Appointing Contractors:

5.2.1 The TSP shall conform to the requirements as provided in this Agreement while appointing Contractor(s) for procurement of goods & services.

5.2.2 The appointment of such Contractor(s) shall neither relieve the TSP of any of its obligations under this Agreement nor make the Nodal Agency liable for the performance of such Contractor(s).

5.3 Monthly Progress Reporting:

The TSP shall provide to the CEA, Nodal Agency & Independent Engineer, on a monthly basis, progress reports along with likely completion date of each Element with regard to the Project and its execution (in accordance with prescribed form). The Nodal Agency/ CEA shall monitor the development of the Project for its timely completion for improving and augmenting the electricity system as a part of its statutory responsibility.

5.4 Quality of Workmanship:

The TSP shall ensure that the Project is designed, built and completed in a good workmanship using sound engineering and construction practices, and using only materials and equipment that are new and manufactured as per the MQP and following approved FQP for erection, testing & commissioning and complying with Indian /International Standards such that, the useful life of the Project will be at least thirty-five (35) years from the COD of the Project.

The TSP shall ensure that all major substation equipment / component (e.g. transformers, reactors, Circuit Breakers, Instrument Transformers (IT), Surge Arresters (SA), Protection relays, clamps & connectors etc.), equipment in terminal stations of HVDC installations including Thyristor/ IGBT valves, Converter Transformers, smoothing reactors, Transformer bushings and wall

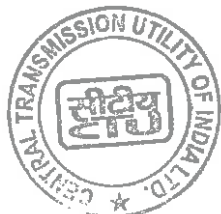

84



bushings, GIS bus ducts, towers and gantry structures and transmission towers or poles and line materials (conductors, earthwire, OPGW, insulator, accessories for conductors, OPGW & earthwires, hardware fittings for insulators, aviation lights etc), facilities and system shall be designed, constructed and tested (Type test, Routine tests, Factory Acceptance Test (FAT)) in accordance with relevant CEA Regulations and Indian Standards. In case Indian Standards for any particular equipment/ system/ process is not available, IEC/ IEEE or equivalent International Standards and Codes shall be followed.

5.5 Progress Monitoring & Quality Assurance:

- 5.5.1 The Project Execution Plan submitted by the TSP in accordance with Article 3.1.3 c) shall comprise of detailed schedule of all the equipment/items /materials required for the Project, right from procurement of raw material till the dispatch from works and receipt at the site. Further, it should also include various stages of the construction schedule up to the commissioning of the Project.
- 5.5.2 Nodal Agency, CEA & Independent Engineer shall have access at all reasonable times to the Site and to the Manufacturer's works and to all such places where the Project is being executed.
- 5.5.3 Independent Engineer shall ensure conformity of the conductor specifications with the functional specifications specified in RFP.
- 5.5.4 The Independent Engineer shall monitor the following during construction of the Project:
- Quality of equipment, material, foundation, structures and workmanship etc. as laid down in Article 5.4 and 6.1.4 of the TSA. Specifically, quality of Sub-station equipment, transmission line material and workmanship etc. would be checked in accordance with the Article 5.4.
 - Progress in the activities specified in Condition Subsequent
 - Verification of readiness of the elements including the statutory clearances & completion of civil works, fixing of all components and finalisation of punch points (if any) prior to charging of the elements
 - Progress of construction of substation and Transmission Lines
- 5.5.5 The progress shall be reviewed by the Independent Engineer against the Project Execution Plan. The Independent Engineer shall prepare its report on monthly basis and submit the same to Nodal Agency highlighting the progress achieved till the end of respective month vis-à-vis milestone activities, areas of concern, if any, which may result in delay in the timely completion of the Project. Based on



85

the progress, Nodal Agency and/ or CEA shall issue written instructions to the TSP to take corrective measures, as may be prudent for the timely completion of the Project. In case of any deficiency, the Nodal Agency would be at liberty to take action in accordance with the procedure of this Agreement.

- 5.5.6 For any delay in commissioning any critical Element(s), as identified in Schedule 1 & Schedule 2 of this Agreement, beyond a period of 45 days shall lead to a sequestration of 10% of the Contract Performance Guarantee.

5.6 Site regulations and Construction Documents

The TSP shall abide by the Safety Rules and Procedures as mentioned in Schedule 3 of this Agreement

The TSP shall retain at the Site and make available for inspection at all reasonable times, copies of the Consents, Clearances and Permits, construction drawings and other documents related to construction.

5.7 Supervision of work:

The TSP shall provide all necessary superintendence for execution of the Project and its supervisory personnel shall be available to provide full-time superintendence for execution of the Project. The TSP shall provide skilled personnel who are experienced in their respective fields.

5.8 Remedial Measures:

The TSP shall take all necessary actions for remedying the shortfall in achievement of timely progress in execution of the Project, if any, as intimated by the Independent Engineer and/ or CEA and/ or the Nodal Agency. However, such intimation by the Independent Engineer and/ or CEA and/ or the Nodal Agency and the subsequent effect of such remedial measures carried out by the TSP shall not relieve the TSP of its obligations in the Agreement. Independent Engineer and/ or CEA and/ or the Nodal Agency may carry out random inspections during the Project execution, as and when deemed necessary by it. If the shortfalls as intimated to the TSP are not remedied to the satisfaction of the CEA and/ or the Nodal Agency, this Agreement may be terminated by the Nodal Agency by giving a Termination Notice to the TSP, in writing, of at least seven (7) days, with a copy to CEA and the Lenders' Representative in order to enable the Lenders to exercise right of substitution in accordance with Article 15.3 of this Agreement.

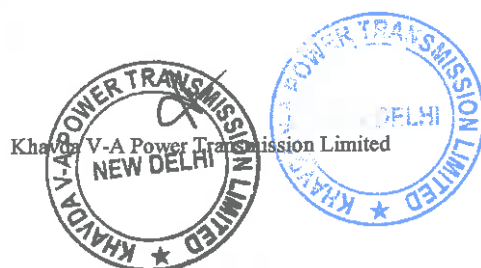
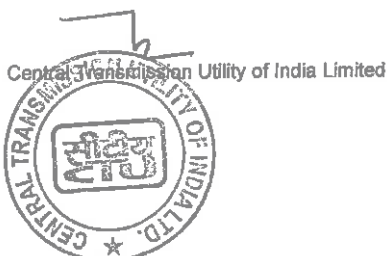

ARTICLE: 6

6 Connection and commissioning of the Project

6.1 Connection with the Inter-Connection Facilities:

- 6.1.1 The TSP shall give the RLDC(s), CTU, / STU, as the case may be, and any other agencies as required, at least sixty (60) days advance written notice of the date on which it intends to connect an Element of the Project, which date shall not be earlier than its Scheduled COD or Schedule COD extended as per Article 4.4.1 & 4.4.2 of this Agreement, unless mutually agreed to by Parties. Further, any preponing of COD of any element prior to Scheduled COD must be approved by the Nodal Agency.
- 6.1.2 The RLDC / SLDC (as the case may be) or the CTU / STU (as the case may be), for reasonable cause, including non-availability of Interconnection Facilities as per Article 4.2, can defer the connection for up to fifteen (15) days from the date notified by the TSP pursuant to Article 6.1.1, if it notifies to the TSP in writing, before the date of connection, of the reason for the deferral and when the connection is to be rescheduled. However, no such deferment on one or more occasions would be for more than an aggregate period of thirty (30) days. Further, the Scheduled COD would be extended as required, for all such deferments on "day to day" basis.
- 6.1.3 Subject to Articles 6.1.1 and 6.1.2, any Element of Project may be connected with the Interconnection Facilities when:
- it has been completed in accordance with this Agreement and the Connection Agreement;
 - it meets the Grid Code, Central Electricity Authority (Technical Standards for Connectivity to the Grid) Regulations, 2007 as amended from time to time and all other Indian legal requirements, and
 - The TSP has obtained the approval in writing of the Electrical Inspector certifying that the Element is ready from the point of view of safety of supply and can be connected with the Interconnection Facilities.
 - It has satisfactorily met all the testing requirements as per Articles 6.1.4
- 6.1.4 Site Acceptance Test (SAT)/ pre-commissioning tests of all major substation equipment, component, system, facilities shall be successfully carried out before commissioning. The Type tests, FAT and SAT reports should be available at the



87



substation / terminal station of HVDC installations for ready reference of operation and maintenance staff and has to be made available to the Independent Engineer appointed for quality monitoring or their authorised representatives, as and when they wish to examine the same.

6.2 Commercial Operation:

6.2.1 An Element of the Project shall be declared to have achieved COD twenty-four (24) hours following the connection of the Element with the Interconnection Facilities pursuant to Article 6.1 or seven (7) days after the date on which it is declared by the TSP to be ready for charging but is not able to be charged for reasons not attributable to the TSP subject to Article 6.1.2.

Provided that an Element shall be declared to have achieved COD only after all the Element(s), if any, which are pre-required to have achieved COD as defined in Schedule 2 of this Agreement, have been declared to have achieved their respective COD.

6.2.2 Once any Element of the Project has been declared to have achieved deemed COD as per Article 6.2.1 above, such Element of the Project shall be deemed to have Availability equal to the Target Availability till the actual charging of the Element and to this extent, TSP shall be eligible for the Monthly Transmission Charges applicable for such Element

6.3 Compensation for Direct Non Natural Force Majeure Event or Indirect Non Natural Force Majeure Event or Natural Force Majeure Event (affecting the Nodal Agency)

6.3.1 If the TSP is otherwise ready to connect the Element(s) of the Project and has given due notice, as per provisions of Article 6.1.1, to the concerned agencies of the date of intention to connect the Element(s) of the Project, where such date is not before the Scheduled COD, but is not able to connect the Element(s) of the Project by the said date specified in the notice, due to Direct Non Natural Force Majeure Event or Indirect Non Natural Force Majeure Event or Natural Force Majeure Event affecting the Nodal Agency, provided such Direct Non Natural Force Majeure Event or Indirect Non Natural Force Majeure Event or Natural Force Majeure Event affecting the Nodal Agency has continued for a period of more than three (3) continuous or non-continuous Months, the TSP shall, until the effects of the Direct Non Natural Force Majeure Event or of Indirect Non Natural Force Majeure Event or Natural Force Majeure Event affecting the Nodal Agency no longer prevent the TSP from connecting the Element(s) of the Project, be deemed to have achieved COD relevant to that date and to this extent, be deemed to have been providing Transmission Service with effect from the date notified, and shall be treated as follows:



88



- a. In case of delay due to Direct Non Natural Force Majeure Event, TSP is entitled for Transmission Charges calculated on Target Availability for the period of such events in excess of three (3) continuous or non-continuous Months in the manner provided in (c) below.
- b. In case of delay due to Indirect Non Natural Force Majeure Event or Natural Force Majeure Event affecting the Nodal Agency, TSP is entitled for payment for debt service which is due under the Financing Agreements, subject to a maximum of Transmission Charges calculated on Target Availability, for the period of such events in excess of three (3) continuous or non-continuous Months in the manner provided in (c) below.
- c. In case of delay due to Direct Non Natural Force Majeure Event or Indirect Non Natural Force Majeure Event or Natural Force Majeure Event affecting the Nodal Agency, the TSP is entitled for payments mentioned in (a) and (b) above, after commencement of Transmission Service, in the form of an increase in Transmission Charges. These amounts shall be paid from the date, being the later of a) the date of cessation of such Indirect Non Natural Force Majeure Event or Natural Force Majeure Event affecting the Nodal Agency and b) the completion of sixty (60) days from the receipt of the Financing Agreements by the Nodal Agency from the TSP.

Provided such increase in Transmission Charges shall be so as to put the TSP in the same economic position as the TSP would have been in case the TSP had been paid amounts mentioned in (a) and (b) above in a situation where the Force Majeure Event had not occurred.

For the avoidance of doubt, it is clarified that the charges payable under this Article 6.3.1 shall be recovered as per Sharing Regulations.

6.4 Liquidated Damages for Delay in achieving COD of Project:

- 6.4.1 If the TSP fails to achieve COD of any Element of the Project or the Project, by the Element's / Project's Scheduled COD or such Scheduled COD as extended under Articles 4.4.1 and 4.4.3, then the TSP shall pay to the Nodal Agency, a sum equivalent to 3.33% of Monthly Transmission Charges applicable for the Element of the Project [in case where no Elements have been defined, to be on the Project as a whole] / Project, for each day of delay up to sixty (60) days of delay and beyond that time limit, at the rate of five percent (5%) of the Monthly Transmission Charges applicable to such Element / Project, as liquidated damages for such delay and not as penalty, without prejudice to any rights of the Nodal Agency under the Agreement.

Central Transmission Utility of India Limited



34

89



- 6.4.2 The TSP's maximum liability under this Article 6.4 shall be limited to the amount of liquidated damages calculated in accordance with Article 6.4.1 for and up to six (6) months of delay for the Element or the Project.

Provided that, in case of failure of the TSP to achieve COD of the Element of the Project even after the expiry of six (6) months from its Scheduled COD, the provisions of Article 13 shall apply.

- 6.4.3 The TSP shall make payment to the Nodal Agency of the liquidated damages calculated pursuant to Article 6.4.1 within ten (10) days of the earlier of:
- the date on which the applicable Element achieves COD; or
 - the date of termination of this Agreement.

The payment of such damages shall not relieve the TSP from its obligations to complete the Project or from any other obligation and liabilities under the Agreement.

- 6.4.4 If the TSP fails to pay the amount of liquidated damages to the Nodal Agency within the said period of ten (10) days, the Nodal Agency shall be entitled to recover the said amount of the liquidated damages by invoking the Contract Performance Guarantee. If the then existing Contract Performance Guarantee is for an amount which is less than the amount of the liquidated damages payable by the TSP to the Nodal Agency under this Article 6.3 and the TSP fails to make payment of the balance amount of the liquidated damages not covered by the Contract Performance Guarantee, then such balance amount shall be deducted from the Transmission Charges payable to the TSP. The right of the Nodal Agency to encash the Contract Performance Guarantee is without prejudice to the other rights of the Nodal Agency under this Agreement.

- 6.4.5 For avoidance of doubt, it is clarified that amount payable by TSP under this Article is over and above the penalty payable by TSP under Article 5.5.6 of this Agreement.

6.5 Return of Contract Performance Guarantee

- 6.5.1 The Contract Performance Guarantee as submitted by TSP in accordance with Article 3.1.1 shall be released by the Nodal Agency within three (3) months from the COD of the Project. In the event of delay in achieving Scheduled COD of any of the Elements by the TSP (otherwise than due to reasons as mentioned in Article 3.1.3 or Article 11) and consequent part invocation of the Contract Performance Guarantee by the Nodal Agency, Nodal Agency shall release the Contract Performance Guarantee, if any remaining unadjusted, after the satisfactory completion by the TSP of all the requirements regarding achieving

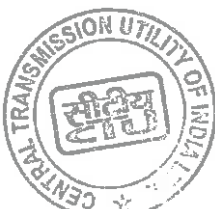

Transmission Service Agreement

the Scheduled COD of the remaining Elements of the Project. It is clarified that the Nodal Agency shall also return / release the Contract Performance Guarantee in the event of (i) applicability of Article 3.3.2 to the extent the Contract Performance Guarantee is valid for an amount in excess of Rs. 714.00 Crore (Rupees Seven Hundred Fourteen Crore only), or (ii) termination of this Agreement by the Nodal Agency as mentioned under Article 3.3.4 of this Agreement.

6.5.2 The release of the Contract Performance Guarantee shall be without prejudice to other rights of the Nodal Agency under this Agreement.

Central Transmission Utility of India Limited



36

Khavda V-A Power Transmission Limited



91

ARTICLE: 7

7 Operation and Maintenance of the Project

7.1 Operation and Maintenance of the Project:

The TSP shall be responsible for ensuring that the Project is operated and maintained in accordance with the regulations made by the Commission and CEA from time to time and provisions of the Act.

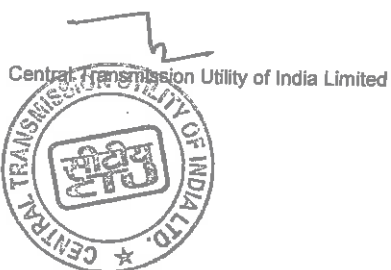

ARTICLE: 8

8 Availability of the project

8.1 Calculation of Availability of the Project:

Calculation of Availability for the Elements and for the Project, as the case may be, shall be as per Appendix –IV to Central Electricity Regulatory Commission (Terms and Conditions of Tariff) Regulations, 2024, as applicable on the Bid Deadline and as appended in Schedule 6 of this Agreement.

8.2 Target Availability:

The Target Availability of each Element and the Project shall be 95%.

Payment of monthly Transmission charges based on actual availability will be calculated as per para 1.2 of Schedule 4 of this Agreement.

If the availability of any Element or the Project is below the Target Availability, for six consecutive months in a Contract Year, the DIC(s) or the Nodal Agency may issue a show cause notice to the TSP, asking them to show cause as to why the Transmission Service Agreement be not terminated, and if no satisfactory cause is shown it may terminate the Agreement. If the Nodal Agency is of the opinion that the transmission system is of critical importance, it may carry out or cause to carry the operation and maintenance of transmission system at the risk and cost of TSP.

Central Transmission Utility of India Limited

38

Khavda V-A Power Transmission Limited

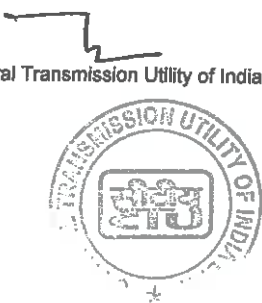

93

ARTICLE: 9

9 Insurances

9.1 Insurance:

9.1.1 The TSP shall effect and maintain or cause to be effected and maintained during the Construction Period and the Operating Period, adequate Insurances against such risks, with such deductibles including but not limited to any third party liability and endorsements and co-beneficiary/insured, as may be necessary under

- a. any of the Financing Agreements,
- b. the Laws, and
- c. in accordance with Prudent Utility Practices.

The Insurances shall be taken effective from a date prior to the date of the Financial Closure till the Expiry Date.

9.2 Evidence of Insurance cover:

9.2.1 The TSP shall furnish to the Nodal Agency copies of certificates and policies of the Insurances, as and when the Nodal Agency may seek from the TSP as per the terms of Article 9.1

9.3 Application of Insurance Proceeds:

9.3.1 Save as expressly provided in this Agreement, the policies of Insurances and the Financing Agreements, the proceeds of any insurance claim made due to loss or damage to the Project or any part of the Project shall be first applied to reinstatement, replacement or renewal of such loss or damage.

9.3.2 If a Natural Force Majeure Event renders the Project no longer economically and technically viable and the insurers under the Insurances make payment on a "total loss" or equivalent basis, the portion of the proceeds of such Insurance available to the TSP (after making admissible payments to the Lenders as per the Financing Agreements) shall be allocated only to the TSP. Nodal Agency and / or concerned Designated ISTS Customers shall have no claim on such proceeds of the Insurance.

9.3.3 Subject to the requirements of the Lenders under the Financing Agreements, any dispute or difference between the Parties as to whether the Project is no longer economically and technically viable due to a Force Majeure Event or whether that event was adequately covered in accordance with this Agreement by the



94

Insurances shall be determined in accordance with Article 16.

9.4 Effect on liability of the Nodal Agency / Designated ISTS Customers

9.4.1 The Nodal Agency and / or the Designated ISTS Customers shall have no financial obligations or liability whatsoever towards the TSP in respect of this Article 9.

Central Transmission Utility of India Limited



Khavda V-A Power Transmission Limited



95

ARTICLE: 10

10 Billing and Payment of Transmission Charges

10.1 Subject to provisions of this Article 10, the Monthly Transmission Charges shall be paid to the TSP, in Indian Rupees, on monthly basis as per the provisions of the Sharing Regulations, from the date on which an Element(s) has achieved COD until the Expiry Date of this Agreement, unless terminated earlier and in line with the provisions of Schedule 4 of this Agreement.

10.2 Calculation of Monthly Transmission Charges:

The Monthly Transmission Charges for each Contract Year including Incentive & Penalty payment shall be calculated in accordance with the provisions of Schedule 4 of this Agreement.

10.3 Rebate & Late Payment Surcharge:

The rebate and late payment surcharge shall be governed as per Sharing Regulations.

10.4 Disputed Bills, Default in payment by the Designated ISTS Customers & Annual Reconciliation:

Any Disputed Bill, Default in payment by the Designated ISTS Customers & Annual Reconciliation shall be governed as per Sharing Regulations.

Central Transmission Utility of India Limited

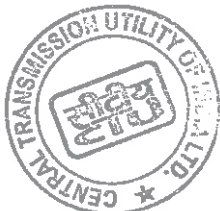

41

96

Khayda V-A Power Transmission Limited



ARTICLE: 11

11 Force Majeure

11.1 Definitions

11.1.1 The following terms shall have the meanings given hereunder.

11.2 Affected Party

11.2.1 An Affected Party means any Party whose performance has been affected by an event of Force Majeure.

11.2.2 Any event of Force Majeure shall be deemed to be an event of Force Majeure affecting the TSP only if the Force Majeure event affects and results in, late delivery of machinery and equipment for the Project or construction, completion, commissioning of the Project by Scheduled COD and/or operation thereafter;

11.3 Force Majeure

A 'Force Majeure' means any event or circumstance or combination of events and circumstances including those stated below that wholly or partly prevents or unavoidably delays an Affected Party in the performance of its obligations/ roles under this Agreement, but only if and to the extent that such events or circumstances are not within the reasonable control, directly or indirectly, of the Affected Party and could not have been avoided if the Affected Party had taken reasonable care or complied with Prudent Utility Practices:

(a) Natural Force Majeure Events:

- i. act of God, including, but not limited to drought, fire and explosion (to the extent originating from a source external to the Site), earthquake, volcanic eruption, landslide, flood, cyclone, typhoon, tornado, or exceptionally adverse weather conditions, which are in excess of the statistical measures for the last hundred (100) years; and
- ii. epidemic/ pandemic notified by Indian Governmental Instrumentality.

(b) Non-Natural Force Majeure Events :

- i. Direct Non-Natural Force Majeure Events
 - Nationalization or compulsory acquisition by any Indian Governmental Instrumentality of any material assets or rights of the Affected Party; or

Central Transmission Utility of India Limited



97

- the unlawful, unreasonable or discriminatory revocation of, or refusal to renew, any Consents, Clearances and Permits required by the Affected Party to perform their obligations/ roles under the RFP Project Documents or any unlawful, unreasonable or discriminatory refusal to grant any other Consents, Clearances and Permits required for the development/ operation of the Project, provided that a Competent Court of Law declares the revocation or refusal to be unlawful, unreasonable and discriminatory and strikes the same down; or
- any other unlawful, unreasonable or discriminatory action on the part of an Indian Governmental Instrumentality which is directed against the Project, provided that a Competent Court of Law declares the action to be unlawful, unreasonable and discriminatory and strikes the same down.

ii. Indirect Non - Natural Force Majeure Events

- act of war (whether declared or undeclared), invasion, armed conflict or act of foreign enemy, blockade, embargo, revolution, riot, insurrection, terrorist or military action; or
- radioactive contamination or ionising radiation originating from a source in India or resulting from any other Indirect Non Natural Force Majeure Event mentioned above, excluding circumstances where the source or cause of contamination or radiation is brought or has been brought into or near the Site by the Affected Party or those employed or engaged by the Affected Party; or
- industry-wide strikes and labour disturbances, having a nationwide impact in India.

11.4 Force Majeure Exclusions

11.4.1 Force Majeure shall not include (i) any event or circumstance which is within the reasonable control of the Parties and (ii) the following conditions, except to the extent that they are consequences of an event of Force Majeure:

- (a) Unavailability, late delivery, or changes in cost of the machinery, equipment, materials, spare parts etc. for the Project;
- (b) Delay in the performance of any Contractors or their agents;
- (c) Non-performance resulting from normal wear and tear typically experienced in transmission materials and equipment;

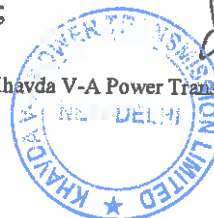
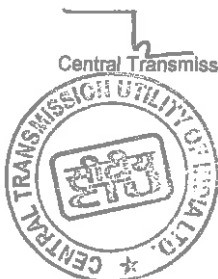

- (d) Strikes or labour disturbance at the facilities of the Affected Party;
- (e) Insufficiency of finances or funds or the Agreement becoming onerous to perform; and
- (f) Non-performance caused by, or connected with, the Affected Party's:
 - i. negligent or intentional acts, errors or omissions;
 - ii. failure to comply with an Indian Law; or
 - iii. breach of, or default under this Agreement or any Project Documents.
- (g) Any error or omission in the survey report provided by BPC during the bidding process.

11.5 Notification of Force Majeure Event

11.5.1 The Affected Party shall give notice to the other Party of any event of Force Majeure as soon as reasonably practicable, but not later than seven (7) days after the date on which such Party knew or should reasonably have known of the commencement of the event of Force Majeure. If an event of Force Majeure results in a breakdown of communications rendering it unreasonable to give notice within the applicable time limit specified herein, then the Party claiming Force Majeure shall give such notice as soon as reasonably practicable after reinstatement of communications, but not later than one (1) day after such reinstatement.

Provided that, such notice shall be a pre-condition to the Affected Party's entitlement to claim relief under this Agreement. Such notice shall include full particulars of the event of Force Majeure, its effects on the Party claiming relief and the remedial measures proposed. The Affected Party shall give the other Party regular reports on the progress of those remedial measures and such other information as the other Party may reasonably request about the Force Majeure.

11.5.2 The Affected Party shall give notice to the other Party of (i) the cessation of the relevant event of Force Majeure; and (ii) the cessation of the effects of such event of Force Majeure on the performance of its rights or obligations/ roles under this Agreement, as soon as practicable after becoming aware of each of these cessations.

11.6 Duty to perform and duty to mitigate

To the extent not prevented by a Force Majeure Event, the Affected Party shall continue to perform its obligations/ roles as provided in this Agreement. The

Central Transmission Utility of India Limited



44

99



Affected Party shall use its reasonable efforts to mitigate the effect of any event of Force Majeure as soon as practicable.

11.7 Available Relief for a Force Majeure Event

Subject to this Article 11,

- (a) no Party shall be in breach of its obligations/ roles pursuant to this Agreement to the extent that the performance of its obligations/ roles was prevented, hindered or delayed due to a Force Majeure Event;
- (b) each Party shall be entitled to claim relief for a Force Majeure Event affecting its performance in relation to its obligations/ roles under Articles 3.3.4, 4.4.2 and 6.3.1 of this Agreement.
- (c) For the avoidance of doubt, it is clarified that the computation of Availability of the Element(s) under outage due to Force Majeure Event, as per Article 11.3 affecting the TSP shall be as per Appendix –IV to Central Electricity Regulatory Commission (Terms and Conditions of Tariff) Regulations, 2024 as on Bid Deadline. For the event(s) for which the Element(s) is/are deemed to be available as per Appendix –IV to Central Electricity Regulatory Commission (Terms and Conditions of Tariff) Regulations, 2024, then the Transmission Charges, as applicable to such Element(s), shall be payable as per Schedule 4, for the duration of such event(s).
- (d) For so long as the TSP is claiming relief due to any Force Majeure Event under this Agreement, the Nodal Agency may, if it so desires, from time to time on one (1) day notice, inspect the Project and the TSP shall provide the Nodal Agency's personnel with access to the Project to carry out such inspections.
- (e) For avoidance of doubt, the TSP acknowledges that for extension of Scheduled COD a period up to one hundred eighty (180) days due to Force Majeure event, no compensation on the grounds such as interest cost, incident expenditure, opportunity cost will be made to the TSP. However, if Scheduled COD is extended beyond a period of one hundred eighty (180) days due to Force Majeure event, the TSP will be allowed to recover the interest cost during construction corresponding to the period exceeding one hundred eighty (180) days by adjustment in the Transmission Charges in accordance with Schedule 9.

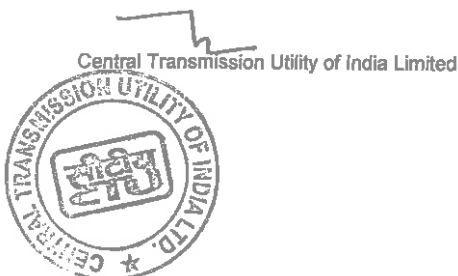

A



ARTICLE: 12

12 Change in Law

12.1 Change in Law

12.1.1 Change in Law means the occurrence of any of the following after the Bid Deadline resulting into any additional recurring / non-recurring expenditure by the TSP or any savings of the TSP:

- the enactment, coming into effect, adoption, promulgation, amendment, modification or repeal (without re-enactment or consolidation) in India, of any Law, including rules and regulations framed pursuant to such Law, subject to the provisions under Article 12.1.2;
- a change in the interpretation or application of any Law by any Indian Governmental Instrumentality having the legal power to interpret or apply such Law, or any Competent Court of Law;
- the imposition of a requirement for obtaining any Consents, Clearances and Permits which was not required earlier;
- a change in the terms and conditions prescribed for obtaining any Consents, Clearances and Permits or the inclusion of any new terms or conditions for obtaining such Consents, Clearances and Permits;
- any change in the licensing regulations of the Commission, under which the Transmission License for the Project was granted if made applicable by such Commission to the TSP;
- change in wind zone; or
- any change in tax or introduction of any tax made applicable for providing Transmission Service by the TSP as per the terms of this Agreement.

12.1.2 Notwithstanding anything contained in this Agreement, Change in Law shall not cover any change:

- a) Taxes on corporate income; and
- b) Withholding tax on income or dividends distributed to the shareholders of the TSP.

Central Transmission Utility of India Limited



46



101

12.2 Relief for Change in Law

12.2.1 During Construction Period, the impact of increase/decrease in the cost of the Project on the Transmission Charges shall be governed by the formula given in Schedule 9 of this Agreement.

12.2.2 During the Operation Period:

During the operation period, if as a result of Change in Law, the TSP suffers or is benefited from a change in costs or revenue, the aggregate financial effect of which exceeds 0.30% (zero point three percent) of the Annual Transmission Charges in aggregate for a Contract Year, the TSP may notify so to the Nodal Agency and propose amendments to this Agreement so as to place the TSP in the same financial position as it would have enjoyed had there been no such Change in Law resulting in change in costs or revenue as aforesaid.

12.2.3 For any claims made under Articles 12.2.1 and 12.2.2 above, the TSP shall provide to the Nodal Agency documentary proof of such increase / decrease in cost of the Project / revenue for establishing the impact of such Change in Law.

In cases where Change in Law results in decrease of cost and it comes to the notice of Nodal Agency that TSP has not informed Nodal Agency about such decrease in cost, Nodal Agency may initiate appropriate claim.

12.3 Notification of Change in Law:

12.3.1 If the TSP is affected by a Change in Law in accordance with Article 12.1 and wishes to claim relief for such Change in Law under this Article 12, it shall give notice to Nodal Agency of such Change in Law as soon as reasonably practicable after becoming aware of the same.

12.3.2 The TSP shall also be obliged to serve a notice to the Nodal Agency even when it is beneficially affected by a Change in Law.

12.3.3 Any notice served pursuant to Articles 12.3.1 and 12.3.2 shall provide, amongst other things, precise details of the Change in Law and its estimated impact on the TSP.

12.4 Payment on account of Change in Law

The payment for Change in Law shall be through a separate Bill. However, in case of any change in Monthly Transmission Charges by reason of Change in Law, as determined in accordance with this Agreement, the Bills to be raised by the Nodal Agency after such change in Transmission Charges shall appropriately reflect the changed Monthly Transmission Charges.

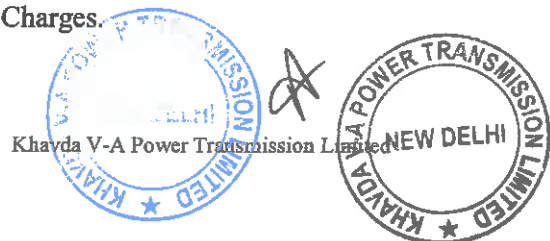
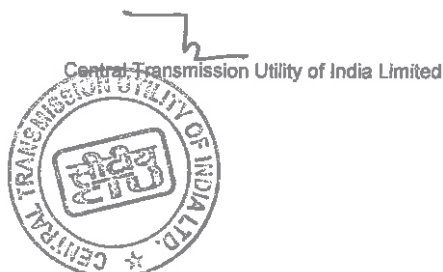

ARTICLE: 13

13 Events of Default and Termination

13.1 TSP's Event of Default

The occurrence and continuation of any of the following events shall constitute a TSP Event of Default, unless any such TSP Event of Default occurs as a result of any non-fulfilment of its obligations as prescribed under this Agreement by the Nodal Agency or a Force Majeure Event:

- a. After having taken up the construction of the Project, the abandonment by the TSP or the TSP's Contractors of the construction of the Project for a continuous period of two (2) months and such default is not rectified within thirty (30) days from the receipt of notice from the Nodal Agency in this regard;
- b. The failure to commission any Element of the Project by the date falling six (6) months after its Scheduled COD unless extended by Nodal Agency as per provisions of this Agreement;
- c. If the TSP:
 - i. assigns, mortgages or charges or purports to assign, mortgage or charge any of its assets or rights related to the Project in contravention of the provisions of this Agreement; or
 - ii. transfers or novates any of its obligations pursuant to this Agreement, in a manner contrary to the provisions of this Agreement;

Except where such transfer is in pursuance of a Law and

- it does not affect the ability of the transferee to perform, and such transferee has the financial and technical capability to perform, its obligations under this Agreement;
 - is to a transferee who assumes such obligations under the Project and this Agreement remains effective with respect to the transferee;
- d. If:
 - i. The TSP becomes voluntarily or involuntarily the subject of any bankruptcy or insolvency or winding up proceedings and such proceedings remain uncontested for a period of thirty (30) days; or



Transmission Service Agreement

- ii. any winding up or bankruptcy or insolvency order is passed against the TSP; or
- iii. the TSP goes into liquidation or dissolution or a receiver or any similar officer is appointed over all or substantially all of its assets or official liquidator is appointed to manage its affairs, pursuant to Law,

Provided that a dissolution or liquidation of the TSP will not be a TSP's Event of Default, where such dissolution or liquidation of the TSP is for the purpose of a merger, consolidation or reorganization with the prior approval of the Commission as per the provisions of Central Electricity Regulatory Commission (Procedure, terms and Conditions for grant of Transmission License and other related matters) Regulations, 2006 or as amended from time to time; or

- e. Failure on the part of the TSP to comply with the provisions of Article 19.1 of this Agreement; or
- f. the TSP repudiates this Agreement and does not rectify such breach even within a period of thirty (30) days from a notice from the Nodal Agency in this regard; or
- g. after Commercial Operation Date of the Project, the TSP fails to achieve monthly Target Availability of 95%, for a period of six (6) consecutive months or within a non-consecutive period of six (6) months within any continuous aggregate period of eighteen(18) months except where the Availability is affected by Force Majeure Events as per Article 11; or
- h. any of the representations and warranties made by the TSP in Article 17 of this Agreement being found to be untrue or inaccurate. Further, in addition to the above, any of the undertakings submitted by the Selected Bidder at the time of submission of the Bid being found to be breached or inaccurate, including but not limited to undertakings from its Parent Company / Affiliates related to the minimum equity obligation; or
- i. the TSP fails to complete / fulfil all the activities / conditions within the specified period as per Article 3; or
- j. except for the reasons solely attributable to Nodal Agency, the TSP is in material breach of any of its obligations under this Agreement and such material breach is not rectified by the TSP within thirty (30) days of receipt of notice in this regard from the Nodal Agency; or

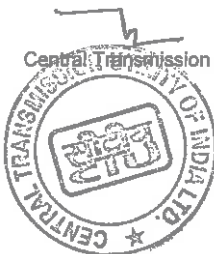

- k. the TSP fails to take the possession of the land required for location specific substations, switching stations or HVDC terminal or inverter stations and / or fails to pay the requisite price to the parties and / or any State Government authority from whom the land is acquired, within twelve (12) months from the Effective Date.

13.2 Termination Procedure for TSP Event of Default

- a. Upon the occurrence and continuance of any TSP's Event of Default under Article 13.1 the Nodal Agency may serve notice on the TSP, with a copy to the CEA and the Lenders' Representative, of their intention to terminate this Agreement (a "Nodal Agency's Preliminary Termination Notice"), which shall specify in reasonable detail, the circumstances giving rise to such Nodal Agency's Preliminary Termination Notice.
- b. Following the issue of a Nodal Agency's Preliminary Termination Notice, the Consultation Period shall apply and would be for the Parties to discuss as to what steps shall be taken with a view to mitigate the consequences of the relevant Event of Default having regard to all the circumstances.
- c. During the Consultation Period, the Parties shall, save as otherwise provided in this Agreement, continue to perform their respective obligations/ roles under this Agreement, and the TSP shall not remove any material, equipment or any part of the Project, without prior consent of the Nodal Agency.

Following the expiry of the Consultation Period, unless the Parties shall have otherwise agreed to the contrary or the circumstances giving rise to Nodal Agency's Preliminary Termination Notice shall have ceased to exist or shall have been remedied, this Agreement may be terminated by the Nodal Agency by giving a Termination Notice to the TSP, in writing, of at least seven (7) days, with a copy to CEA and the Lenders' Representative in order to enable the Lenders to exercise right of substitution in accordance with Article 15.3 of this Agreement.

Further, the Nodal Agency may also initiate proceedings to blacklist the TSP & its Affiliates from participation in any RFP issued by BPCs for a period of 5 years.

13.3 Procedure for Nodal Agency's non-fulfilment of Role

- a. Upon the Nodal Agency not being able to fulfil its role under Article 4.2, the TSP may serve notice on the Nodal Agency, with a copy to CEA and the Lenders' Representative (a "TSP's Preliminary Notice"), which notice shall specify in reasonable detail the circumstances giving rise to such non-fulfilment of role by the Nodal Agency.

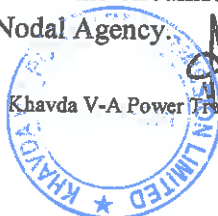

105

- b. Following the issue of a TSP's Preliminary Notice, the Consultation Period shall apply.
- c. The Consultation Period would be for the Parties to discuss as to what steps shall be taken with a view to mitigate the consequences of the relevant non-fulfilment of role by the Nodal Agency including giving time extension to TSP, having regard to all the circumstances.
- d. During the Consultation Period, both Parties shall, save as otherwise provided in this Agreement, continue to perform their respective obligations/ roles under this Agreement.

13.4 Termination due to Force Majeure

- 13.4.1 In case the Parties could not reach an agreement pursuant to Articles 3.3.4 and 4.4.2 of this Agreement and the Force Majeure Event or its effects continue to be present, the Nodal Agency shall have the right to cause termination of the Agreement. In case of such termination, the Contract Performance Guarantee shall be returned to the TSP as per the provisions of Article 6.5.1.



106

13.4.2 In case of termination of this Agreement, the TSP shall provide to the Nodal Agency the full names and addresses of its Contractors as well as complete designs, design drawings, manufacturing drawings, material specifications and technical information, as required by the Nodal Agency within thirty (30) days of Termination Notice.

13.5 Termination or amendment due to non-requirement of any Element or Project during construction

13.5.1 In case any Element or Project, which is under construction, is no longer required due to any reason whatsoever, the Nodal Agency may issue a notice to this effect to the TSP.

13.5.2 Nodal agency may also issue notice to the TSP seeking their response to the proposed termination/ amendment (as the case may be) of the Agreement. The Nodal Agency shall issue copy of such notice to Lenders. In the notice, Nodal Agency shall also include an assessment of the physical progress made by TSP in the Element/ Project (as the case may be) that is no longer required.

13.5.3 The TSP shall neither carry out further investment nor carry out any work on the Element/ Project (as the case may be) that is no longer required after delivery of the notice.

13.5.4 After taking into account the comments of the TSP, the Nodal Agency may terminate the Agreement or amend it if both Parties agree to the amendment.

13.6 Revocation of the Transmission License

13.6.1 The Commission may, as per the provisions of the Electricity Act, 2003, revoke the Transmission License of the ISTS Licensee. Further, in such a case, the Agreement shall be deemed to have been terminated.

13.7 Termination Payment

13.7.1 If Agreement is terminated on account of Force Majeure Events, non-requirement of any Element or Project during Construction, Nodal Agency's non-fulfilment of Role & TSP's Event of Default, the TSP shall be entitled for Termination Payment equivalent to valuation of Project Assets. Upon payment, the Nodal Agency shall take over the Project Assets.

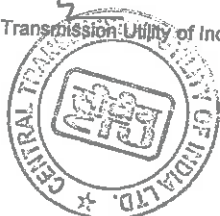

ARTICLE: 14

14 Liability and Indemnification

14.1 Indemnity

14.1.1 The TSP shall indemnify, defend and hold the Nodal Agency harmless against:

- (a) any and all third party claims, actions, suits or proceedings against the Nodal Agency for any loss of or damage to property of such third party, or death or injury to such third party, arising out of a breach by the TSP of any of its obligations under this Agreement, except to the extent that any such claim, action, suit or proceeding has arisen due to a negligent act or omission, breach of this Agreement or non-fulfilment of statutory duty on the part of Nodal Agency; and
- (b) any and all losses, damages, costs and expenses including legal costs, fines, penalties and interest actually suffered or incurred by the Nodal Agency from third party claims arising by reason of:
 - i. a breach by the TSP of any of its obligations under this Agreement, (provided that this Article 14 shall not apply to such breaches by the TSP, for which specific remedies have been provided for under this Agreement) except to the extent that any such losses, damages, costs and expenses including legal costs, fines, penalties and interest (together to constitute "Indemnifiable Losses") has arisen due to a negligent act or omission, breach of this Agreement or non-fulfilment of statutory duty on the part of the Nodal Agency, or
 - ii. any of the representations and warranties of the TSP under this Agreement being found to be inaccurate or untrue.

14.1.2 The Nodal Agency shall, in accordance with the Regulations framed by CERC in this regard, indemnify, defend and hold the TSP harmless against:

- (a) any and all third party claims, actions, suits or proceedings against the TSP, for any loss of or damage to property of such third party, or death or injury to such third party, arising out of any material breach by the Nodal Agency of any of their roles under this Agreement, except to the extent that any such claim, action, suit or proceeding has arisen due to a negligent act or omission, breach of this Agreement or breach of statutory duty on the part of the TSP, its Contractors, servants or agents; and
- (b) any and all losses, damages, costs and expenses including legal costs, fines, penalties and interest ("Indemnifiable Losses") actually suffered or

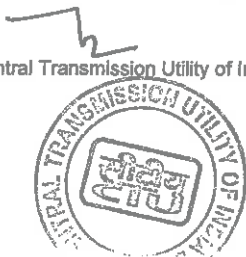

incurred by the TSP from third party claims arising by reason of:

- i. any material breach by the Nodal Agency of any of its roles under this Agreement (provided that, this Article 14 shall not apply to such breaches by the Nodal Agency, for which specific remedies have been provided for under this Agreement), except to the extent that any such Indemnifiable Losses have arisen due to a negligent act or omission, breach of this Agreement or breach of statutory duty on the part of the TSP, its Contractors, servants or agents or
- ii. any of the representations and warranties of the Nodal Agency under this Agreement being found to be inaccurate or untrue.

14.2 Patent Indemnity:

14.2.1

- (a) The TSP shall, subject to the Nodal Agency's compliance with Article 14.2.1 (b), indemnify and hold harmless the Nodal Agency and its employees and officers from and against any and all suits, actions or administrative proceedings, claims, demands, losses, damages, costs, and expenses of whatsoever nature, including attorney's fees and expenses, which the Nodal Agency may suffer as a result of any infringement or alleged infringement of any patent, utility model, registered design, trademark, copyright or other intellectual property right registered or otherwise existing at the date of the Agreement by reason of the setting up of the Project by the TSP.

Such indemnity shall not cover any use of the Project or any part thereof other than for the purpose indicated by or to be reasonably inferred from the Agreement, any infringement resulting from the misuse of the Project or any part thereof, or any products produced in association or combination with any other equipment, plant or materials not supplied by the TSP, pursuant to the Agreement.

- (b) If any proceedings are brought or any claim is made against the Nodal Agency arising out of the matters referred to in Article 14.2.1(a), the Nodal Agency shall promptly give the TSP a notice thereof, and the TSP shall at its own expense take necessary steps and attend such proceedings or claim and any negotiations for the settlement of any such proceedings or claim. The TSP shall promptly notify the Nodal Agency of all actions taken in such proceedings or claims.
- (c) If the TSP fails to notify the Nodal Agency within twenty-eight (28) days



after receipt of such notice from the Nodal Agency under Article 14.2.1(b) above, that it intends to attend any such proceedings or claim, then the Nodal Agency shall be free to attend the same on their own behalf at the cost of the TSP. Unless the TSP has so failed to notify the Nodal Agency within the twenty eight (28) days period, the Nodal Agency shall make no admission that may be prejudicial to the defence of any such proceedings or claims.

- (d) The Nodal Agency shall, at the TSP's request, afford all available assistance to the TSP in attending to such proceedings or claim, and shall be reimbursed by the TSP for all reasonable expenses incurred in so doing.

14.2.2

- (a) The Nodal Agency, in accordance with the Regulations framed by CERC in this regard, subject to the TSP's compliance with Article 14.2.2(b) shall indemnify and hold harmless the TSP and its employees, officers from and against any and all suits, actions or administrative proceedings, claims, demands, losses, damages, costs and expenses of whatsoever nature, including attorney's fees and expenses, which the TSP may suffer as a result of any infringement or alleged infringement of any patent, utility model, registered design, trademark, copyright or other intellectual property right registered or otherwise existing at the date of the Agreement by reason of the setting up of the Project by the TSP.
- (b) If any proceedings are brought or any claim is made against the TSP arising out of the matters referred to in Article 14.2.2 (a) the TSP shall promptly give the Nodal Agency a notice thereof, and the Nodal Agency shall at its own expense take necessary steps and attend such proceedings or claim and any negotiations for the settlement of any such proceedings or claim. The Nodal Agency shall promptly notify the TSP of all actions taken in such proceedings or claims.
- (c) If the Nodal Agency fails to notify the TSP within twenty-eight (28) days after receipt of such notice from the TSP under Article 14.2.2(b) above, that it intends to attend any such proceedings or claim, then the TSP shall be free to attend the same on its own behalf at the cost of the Nodal Agency. Unless the Nodal Agency has so failed to notify the TSP within the twenty (28) days period, the TSP shall make no admission that may be prejudicial to the defence of any such proceedings or claim.
- (d) The TSP shall, at the Nodal Agency request, afford all available assistance to the Nodal Agency in attending to such proceedings or claim, and shall be reimbursed by the Nodal Agency for all reasonable expenses incurred



in so doing.

14.3 Monetary Limitation of liability

14.3.1 A Party ("Indemnifying Party") shall be liable to indemnify the other Party ("Indemnified Party") under this Article 14 for any indemnity claims made in a Contract Year only up to an amount of Rupees Forty Seven Crore and Sixty Lakh only (Rs. 47.60 Crore).

14.4 Procedure for claiming indemnity

14.4.1 Where the Indemnified Party is entitled to indemnification from the Indemnifying Party pursuant to Articles 14.1 or 14.2 the Indemnified Party shall promptly notify the Indemnifying Party of such claim, proceeding, action or suit referred to in Articles 14.1 or 14.2 in respect of which it is entitled to be indemnified. Such notice shall be given as soon as reasonably practicable after the Indemnified Party becomes aware of such claim, proceeding, action or suit. The Indemnifying Party shall be liable to settle the indemnification claim within thirty (30) days of receipt of the above notice.

Provided however that, if:

- i. the Parties choose to contest, defend or litigate such claim, action, suit or proceedings in accordance with Article 14.4.3 below; and
- ii. the claim amount is not required to be paid/deposited to such third party pending the resolution of the Dispute,

the Indemnifying Party shall become liable to pay the claim amount to the Indemnified Party or to the third party, as the case may be, promptly following the resolution of the Dispute, if such Dispute is not settled in favour of the Indemnified Party.

14.4.2 The Indemnified Party may contest, defend and litigate a claim, action, suit or proceeding for which it is entitled to be indemnified under Articles 14.1 or 14.2 and the Indemnifying Party shall reimburse to the Indemnified Party all reasonable costs and expenses incurred by the Indemnified Party. However, such Indemnified Party shall not settle or compromise such claim, action, suit or proceedings without first getting the consent of the Indemnifying Party, which consent shall not be unreasonably withheld or delayed.

14.4.3 An Indemnifying Party may, at its own expense, assume control of the defence of any proceedings brought against the Indemnified Party if it acknowledges its obligation to indemnify such Indemnified Party, gives such Indemnified Party prompt notice of its intention to assume control of the defence, and employs an

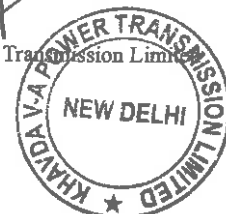

independent legal counsel at its own cost that is reasonably satisfactory to the Indemnified Party.

14.5 Limitation on Liability

14.5.1 Except as expressly provided in this Agreement, neither the TSP nor the Nodal Agency nor their respective officers, directors, agents, employees or Affiliates (including, officers, directors, agents or employees of such Affiliates), shall be liable or responsible to the other Party or its Affiliates including its officers, directors, agents, employees, successors, insurers or permitted assigns for incidental, indirect or consequential, punitive or exemplary damages, connected with or resulting from performance or non-performance of this Agreement, or anything done in connection herewith, including claims in the nature of lost revenues, income or profits (other than payments expressly required and properly due under this Agreement), any increased expense of, reduction in or loss of transmission capacity or equipment used therefore, irrespective of whether such claims are based upon breach of warranty, tort (including negligence, whether of the Nodal Agency, the TSP or others), strict liability, contract, breach of statutory duty, operation of law or otherwise.

14.5.2 The Nodal Agency shall have no recourse against any officer, director or shareholder of the TSP or any Affiliate of the TSP or any of its officers, directors or shareholders for such claims excluded under this Article. The TSP shall also have no recourse against any officer, director or shareholder of the Nodal Agency, or any Affiliate of the Nodal Agency or any of its officers, directors or shareholders for such claims excluded under this Article.

14.6 Duty to Mitigate

The party entitled to the benefit of an indemnity under this Article 14 shall take all reasonable measures to mitigate any loss or damage which has occurred. If the Party fails to take such measures, the other Party's liabilities shall be correspondingly reduced.



112

ARTICLE: 15

15 Assignments and Charges

15.1 Assignments:

15.1.1 This Agreement shall be binding upon, and inure to the benefit of the Parties and their respective successors and permitted assigns. This Agreement shall not be assigned by any Party, except as provided in Article 15.3.

15.2 Permitted Charges:

15.2.1 Neither Party shall create or permit to subsist any encumbrance over all or any of its rights and benefits under this Agreement.

15.2.2 However, the TSP may create any encumbrance over all or part of the receivables, or the Project Assets of the Project in favour of the Lenders or the Lenders' Representative on their behalf, as security for amounts payable under the Financing Agreements and any other amounts agreed by the Parties.

Provided that:

- i. the Lenders or the Lenders' Representative on their behalf shall have entered into the Financing Agreements and agreed in writing to the provisions of this Agreement; and
- ii. any encumbrance granted by the TSP in accordance with this Article 15.2.2 shall contain provisions pursuant to which the Lenders or the Lender's Representative on their behalf agrees unconditionally with the TSP to release from such encumbrances upon payment by the TSP to the Lenders of all amounts due under the Financing Agreements.

15.2.3 Article 15.2.1 does not apply to:

- a. liens arising by operation of law (or by an agreement evidencing the same) in the ordinary course of the TSP developing and operating the Project;
- b. pledges of goods, the related documents of title and / or other related documents, arising or created in the ordinary course of the TSP developing and operating the Project; or
- c. security arising out of retention of title provisions in relation to goods acquired in the ordinary course of the TSP developing and operating the Project.

Central Transmission Utility of India Limited



58



113

15.3 Substitution Rights of the Lenders

- 15.3.1 The TSP would need to operate and maintain the Project under the provisions of this Agreement and cannot assign the Transmission License or transfer the Project or part thereof to any person by sale, lease, exchange or otherwise, without the prior approval of the Nodal Agency.
- 15.3.2 However, in the case of default by the TSP in debt repayments or in the case of default by the TSP as per Article 13 of this Agreement during the debt repayments, the Commission may, on an application from the Lenders, assign the Transmission License to the nominee of the Lenders subject to the fulfilment of the qualification requirements and provisions of the Central Electricity Regulatory Commission (Procedure, terms and Conditions for grant of Transmission License and other related matters) Regulations, 2006 and as amended from time to time.

Central Transmission Utility of India Limited



59

Khavda V-A Power Transmission Limited



Handwritten signature or initials in black ink.



ARTICLE: 16

16 Governing Law and Dispute Resolution

16.1 Governing Law:

This Agreement shall be governed by and construed in accordance with the Laws of India. Any legal proceedings in respect of any matters, claims or disputes under this Agreement shall be under the jurisdiction of appropriate courts in Delhi.

16.2 Amicable Settlement:

16.2.1 Either Party is entitled to raise any claim, dispute or difference of whatever nature arising under, out of or in connection with this Agreement, including its existence or validity or termination or whether during the execution of the Project or after its completion and whether prior to or after the abandonment of the Project or termination or breach of the Agreement by giving a written notice to the other Party, which shall contain:

- (i) a description of the Dispute;
- (ii) the grounds for such Dispute; and
- (iii) all written material in support of its claim.

16.2.2 The other Party shall, within thirty (30) days of issue of notice issued under Article 16.2.1, furnish:

- (i) counter-claim and defences, if any, regarding the Dispute; and
- (ii) all written material in support of its defences and counter-claim.

16.2.3 Within thirty (30) days of issue of notice by the Party pursuant to Article 16.2.1, if the other Party does not furnish any counter claim or defense under Article 16.2.2, or thirty (30) days from the date of furnishing counter claims or defence by the other Party, both the Parties to the Dispute shall meet to settle such Dispute amicably. If the Parties fail to resolve the Dispute amicably within thirty (30) days from the later of the dates mentioned in this Article 16.2.3, the Dispute shall be referred for dispute resolution in accordance with Article 16.3.

16.3 Dispute Resolution:

All Disputes shall be adjudicated by the Commission.

Central Transmission Utility of India Limited



60

Khavda V-A Power Transmission Limited



115

16.4 Parties to Perform Obligations:

Notwithstanding the existence of any Dispute and difference referred to the Commission as provided in Article 16.3 and save as the Commission may otherwise direct by a final or interim order, the Parties hereto shall continue to perform their respective obligations/ roles (which are not in dispute) under this Agreement.

Central Transmission Utility of India Limited

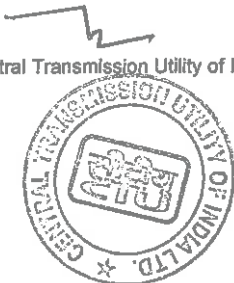

61

Khavda V-A Power Transmission Limited



ARTICLE: 17

17 Representation and Warranties

17.1 Representation and warranties of the Nodal Agency

17.1.1 The Nodal Agency hereby represents and warrants to and agrees with the TSP as follows and acknowledges and confirms that the TSP is relying on such representations and warranties in connection with the transactions described in this Agreement:

- a. It has all requisite powers and authority to execute and consummate this Agreement;
- b. This Agreement is enforceable against the Nodal Agency in accordance with its terms;
- c. The consummation of the transactions contemplated by this Agreement on the part of Nodal Agency will not violate any provision of nor constitute a default under, nor give rise to a power to cancel any charter, mortgage, deed of trust or lien, lease, agreement, license, permit, evidence of indebtedness, restriction, or other contract to which the Nodal Agency is a Party or to which the Nodal Agency is bound, which violation, default or power has not been waived;

17.2 Representation and Warranties of the TSP:

17.2.1 The TSP hereby represents and warrants to and agrees with the Nodal Agency as follows and acknowledges and confirms that the Nodal Agency is relying on such representations and warranties in connection with the transactions described in this Agreement:

- a. It has all requisite powers and has been duly authorized to execute and consummate this Agreement;
- b. This Agreement is enforceable against it, in accordance with its terms;
- c. The consummation of the transactions contemplated by this Agreement on the part of the TSP will not violate any provision of nor constitute a default under, nor give rise to a power to cancel any charter, mortgage, deed of trust or lien, lease, agreement, license, permit, evidence of indebtedness, restriction, or other contract to which the TSP is a Party or to which the TSP is bound which violation, default or power has not been waived;
- d. The TSP is not insolvent and no insolvency proceedings have been instituted, nor threatened or pending by or against the TSP;

Central Transmission Utility of India Limited

62

Khavda V-A Power Transmission Limited



117

Transmission Service Agreement

- e. There are no actions, suits, claims, proceedings or investigations pending or, to the best of the TSP's knowledge, threatened in writing against the TSP at law, in equity, or otherwise, and whether civil or criminal in nature, before or by, any court, commission, arbitrator or governmental agency or authority, and there are no outstanding judgments, decrees or orders of any such courts, commission, arbitrator or governmental agencies or authorities, which materially adversely affect its ability to execute the Project or to comply with its obligations under this Agreement.

17.2.2 The TSP makes all the representations and warranties above to be valid as on the Effective Date of this Agreement.

Central Transmission Utility of India Limited

63

Khavda V-A Power Transmission Limited



ARTICLE: 18

18 Independent Engineer

18.1 Appointment of Independent Engineer

The Nodal Agency shall appoint an agency/ company as Independent Engineer as per framework provided in the Guidelines for Encouraging Competition in Development of Transmission Projects for selection of Independent Engineer.

18.2 Roles and functions of Independent Engineer

The role and functions of the Independent Engineer shall include the following:

- a. Progress Monitoring as required under this Agreement;
- b. Ensuring Quality as required under this Agreement;
- c. determining, as required under the Agreement, the costs of any works or services and/or their reasonableness during construction phase;
- d. determining, as required under the Agreement, the period or any extension thereof, for performing any duty or obligation during construction phase;
- e. determining, as required under the Agreement, the valuation of the Project Assets.
- f. Assisting the Parties in resolution of Disputes and
- g. Undertaking all other duties and functions in accordance with the Agreement.

18.3 Remuneration of Independent Engineer

The fee and charges of the Independent Engineer shall be paid by the Nodal Agency as per terms & conditions of appointment.

18.4 Termination of appointment

18.4.1 The Nodal Agency may, in its discretion, terminate the appointment of the Independent Engineer at any time, but only after appointment of another Independent Engineer.

18.4.2 If the TSP has reason to believe that the Independent Engineer is not discharging its duties and functions in a fair, efficient and diligent manner, it may make a written representation to the Nodal Agency and seek termination of the appointment of the Independent Engineer. Upon receipt of such representation, the Nodal Agency shall hold a tripartite meeting with the TSP and Independent Engineer for an amicable resolution, and the decision of Nodal agency is final. In the event that the

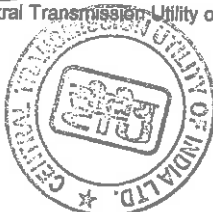

Transmission Service Agreement

appointment of the Independent Engineer is terminated hereunder, the Nodal Agency shall appoint forthwith another Independent Engineer.

18.5 Authorised signatories

The Nodal Agency shall require the Independent Engineer to designate and notify to the Nodal Agency up to 2 (two) persons employed in its firm to sign for and on behalf of the Independent Engineer, and any communication or document required to be signed by the Independent Engineer shall be valid and effective only if signed by any of the designated persons; provided that the Independent Engineer may, by notice in writing, substitute any of the designated persons by any of its employees.

Central Transmission Utility of India Limited



65

Khavda V-A Power Transmission Limited



120

ARTICLE: 19

19 Miscellaneous Provisions

19.1 Equity Lock-in Commitment:

19.1.1 The aggregate equity share holding of the Selected Bidder in the issued and paid up equity share capital of Khavda V-A Power Transmission Limited shall not be less than Fifty one percent (51%) up to a period of one (1) year after COD of the Project.

Provided that, in case the Lead Member or Bidding Company is holding equity through Affiliate/s, Ultimate Parent Company or Parent Company, such restriction as specified above shall apply to such entities.

Provided further, that in case the Selected Bidder is a Bidding Consortium, the Lead Member shall continue to hold equity of at least twenty-six percent (26%) upto a period of one (1) year after COD of the Project and any Member of such Bidding Consortium shall be allowed to divest its equity as long as the other remaining Members (which shall always include the Lead Member) hold the minimum equity specified above.

19.1.2 If equity is held by the Affiliates, Parent Company or Ultimate Parent Company of the Selected Bidder, then, subject to the second proviso to Article 19.1.1, such Affiliate, Parent Company or Ultimate Parent Company shall be eligible to transfer its shareholding in Khavda V-A Power Transmission Limited to another Affiliate or to the Parent Company / Ultimate Parent Company of the Selected Bidder. If any such shareholding entity, qualifying as an Affiliate / Parent Company / Ultimate Parent Company, is likely to cease to meet the criteria to qualify as an Affiliate / Parent Company / Ultimate Parent Company, the shares held by such entity shall be transferred to another Affiliate / Parent Company / Ultimate Parent Company of the Selected Bidder.

19.1.3 Subject to Article 19.1.1, all transfer(s) of shareholding of Khavda V-A Power Transmission Limited by any of the entities referred to in Article 19.1.1 and 19.1.2 above, shall be after prior written intimation to the Nodal Agency.

19.1.4 For computation of effective Equity holding, the Equity holding of the Selected Bidder or its Ultimate Parent Company in such Affiliate(s) or Parent Company and the equity holding of such Affiliate(s) or Ultimate Parent Company in Khavda V-A Power Transmission Limited shall be computed in accordance with the example given below:

If the Parent Company or the Ultimate Parent Company of the Selected Bidder A directly holds thirty percent (30%) of the equity in Khavda V-A Power Transmission Limited then holding of Selected Bidder A in Khavda V-A Power

Central Transmission Utility of India Limited

66

Khavda V-A Power Transmission Limited



Transmission Service Agreement

Transmission Limited shall be thirty percent (30%);

If Selected Bidder A holds thirty percent (30%) equity of the Affiliate and the Affiliate holds fifty percent (50%) equity in Khavda V-A Power Transmission Limited, then, for the purposes of ascertaining the minimum equity/equity lock-in requirements specified above, the effective holding of Bidder A in Khavda V-A Power Transmission Limited shall be fifteen percent (15%), (i.e., 30% x 50%)

19.1.5 The provisions as contained in this Article 19.1 shall override the terms of the consortium agreement submitted as part of the Bid.

19.1.6 The TSP shall be responsible to report to Nodal Agency, within thirty (30) days from the occurrence of any event that would result in any change in its equity holding structure from that which existed as on the date of signing of the Share Purchase Agreement. In such cases, the Nodal Agency would reserve the right to ascertain the equity holding structure and to call for all such required documents / information / clarifications as may be required.

19.2 Commitment of maintaining Qualification Requirement

19.2.1 The Selected Bidder will be required to continue to maintain compliance with the Qualification Requirements, as stipulated in RFP Document, till the COD of the Project. Where the Technically Evaluated Entity and/or the Financially Evaluated Entity is not the Bidding Company or a Member in a Bidding Consortium, as the case may be, the Bidding Company or Member shall continue to be an Affiliate of the Technically Evaluated Entity and/or Financially Evaluated Entity till the COD of the Project.

19.2.2 Failure to comply with the aforesaid provisions shall be dealt in the same manner as TSP's Event of Default as under Article 13 of this Agreement.

19.3 Language:

19.3.1 All agreements, correspondence and communications between the Parties relating to this Agreement and all other documentation to be prepared and supplied under the Agreement shall be written in English, and the Agreement shall be construed and interpreted in accordance with English language.

19.3.2 If any of the agreements, correspondence, communications or documents are prepared in any language other than English, the English translation of such agreements, correspondence, communications or documents shall prevail in matters of interpretation.

19.4 Affirmation

The TSP and the Nodal Agency, each affirm that:

Central Transmission Utility of India Limited

67

Khavda V-A Power Transmission Limited



122

Transmission Service Agreement

1. neither it nor its respective directors, employees, or agents has paid or undertaken to pay or shall in the future pay any unlawful commission, bribe, pay-off or kick-back; and
2. it has not in any other manner paid any sums, whether in Indian currency or foreign currency and whether in India or abroad to the other Party to procure this Agreement, and the TSP and the Nodal Agency hereby undertake not to engage in any similar acts during the Term of Agreement.

19.5 Severability

The invalidity or enforceability, for any reason, of any part of this Agreement shall not prejudice or affect the validity or enforceability of the remainder of this Agreement, unless the part held invalid or unenforceable is fundamental to this Agreement.

19.6 Counterparts

This Agreement may be executed in one or more counterparts, each of which shall be deemed an original and all of which collectively shall be deemed one and the same Agreement.

19.7 Breach of Obligations/ Roles

The Parties acknowledge that a breach of any of the obligations/ roles contained herein would result in injuries. The Parties further acknowledge that the amount of the liquidated damages or the method of calculating the liquidated damages specified in this Agreement is a genuine and reasonable pre-estimate of the damages that may be suffered by the non-defaulting Party in each case specified under this Agreement.

19.8 Restriction of Shareholders / Owners Liability

19.8.1 Parties expressly agree and acknowledge that none of the shareholders of the Parties hereto shall be liable to the other Parties for any of the contractual obligations of the concerned Party under this Agreement.

19.8.2 Further, the financial liabilities of the shareholder(s) of each Party to this Agreement shall be restricted to the extent provided in the Indian Companies Act, 1956 / Companies Act, 2013 (as the case may be).

19.9 Taxes and Duties:

19.9.1 The TSP shall bear and promptly pay all statutory taxes, duties, levies and cess, assessed/levied on the TSP, its Contractors or their employees that are required to be paid by the TSP as per the Law in relation to the execution of the Project and for providing Transmission Service as per the terms of this Agreement.



19.9.2 The Nodal Agency shall be indemnified and held harmless by the TSP against any claims that may be made against the Nodal Agency in relation to the matters set out in Article 19.9.1.

19.9.3 The Nodal Agency shall not be liable for any payment of, taxes, duties, levies, cess whatsoever for discharging any obligation of the TSP by the Nodal Agency on behalf of TSP or its personnel, provided the TSP has consented in writing to the Nodal Agency for such work, for which consent shall not be unreasonably withheld.

19.10 No Consequential or Indirect Losses

The liability of the TSP shall be limited to that explicitly provided in this Agreement.

Provided that, notwithstanding anything contained in this Agreement, under no event shall the Nodal Agency or the TSP claim from one another any indirect or consequential losses or damages.

19.11 Discretion:

Except where this Agreement expressly requires a Party to act fairly or reasonably, a Party may exercise any discretion given to it under this Agreement in any way it deems fit.

19.12 Confidentiality

19.12.1 The Parties undertake to hold in confidence this Agreement and RFP Project Documents and not to disclose the terms and conditions of the transaction contemplated hereby to third parties, except:

- (a) to their professional advisors;
- (b) to their officers, contractors, employees, agents or representatives, financiers, who need to have access to such information for the proper performance of their activities; or
- (c) disclosures required under Law,

without the prior written consent of the other Parties.

Provided that, the TSP agrees and acknowledges that the Nodal Agency, may, at any time, disclose the terms and conditions of the Agreement and the RFP Project Documents to any person, to the extent stipulated under the Law and the Competitive Bidding Guidelines.

19.13 Order of priority in application:

Central Transmission Utility of India Limited

69

Khavda V-A Power Transmission Limited



Transmission Service Agreement

Save as provided in Article 2.5, in case of inconsistencies between the terms and conditions stipulated in Transmission License issued by the Commission to the TSP, agreement(s) executed between the Parties, applicable Law including rules and regulations framed thereunder, the order of priority as between them shall be the order in which they are placed below:

- terms and conditions of Transmission License;
- applicable Law, rules and regulations framed thereunder;
- this Agreement;
- Agreement(s), if any, under Sharing Regulations.

19.14 Independent Entity:

- 19.14.1 The TSP shall be an independent entity performing its obligations pursuant to the Agreement.
- 19.14.2 Subject to the provisions of the Agreement, the TSP shall be solely responsible for the manner in which its obligations under this Agreement are to be performed. All employees and representatives of the TSP or Contractors engaged by the TSP in connection with the performance of the Agreement shall be under the complete control of the TSP and shall not be deemed to be employees, representatives, Contractors of the Nodal Agency and nothing contained in the Agreement or in any agreement or contract awarded by the TSP shall be construed to create any contractual relationship between any such employees, representatives or Contractors and the Nodal Agency.

19.15 Amendments:

- 19.15.1 This Agreement may only be amended or supplemented by a written agreement between the Parties.

19.16 Waiver:

- 19.16.1 No waiver by either Party of any default or breach by the other Party in the performance of any of the provisions of this Agreement shall be effective unless in writing duly executed by an authorised representative of such Party.
- 19.16.2 Neither the failure by either Party to insist on any occasion upon the performance of the terms, conditions and provisions of this Agreement nor time or other indulgence granted by one Party to the other Parties shall act as a waiver of such breach or acceptance of any variation or the relinquishment of any such right or any other right under this Agreement, which shall remain in full force and effect.

Central Transmission Utility of India Limited

70

Khavda V-A Power Transmission Limited

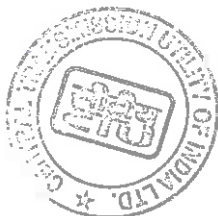

125

19.17 Relationship of the Parties:

This Agreement shall not be interpreted or construed to create an association, joint venture, or partnership or agency or any such other relationship between the Parties or to impose any partnership obligation or liability upon either Party and neither Party shall have any right, power or authority to enter into any agreement or undertaking for, or act on behalf of, or to act as or be an agent or representative of, or to otherwise bind, the other Party.

19.18 Entirety:

19.18.1 This Agreement along with its sections, schedules and appendices is intended by the Parties as the final expression of their agreement and is intended also as a complete and exclusive statement of the terms of their agreement.

19.18.2 Except as provided in this Agreement, all prior written or oral understandings, offers or other communications of every kind pertaining to this Agreement or the provision of Transmission Service under this Agreement to the Nodal Agency by the TSP shall stand superseded and abrogated.

19.19 Notices:

19.19.1 All notices or other communications which are required to be given under this Agreement shall be in writing and in the English language

19.19.2 If to the TSP, all notices or communications must be delivered personally or by registered post or facsimile or any other mode duly acknowledged to the addressee below:

	<u>Corporate</u>	<u>Business</u>
Address	: Plot No-2, Saudamini, : Sec-29, Gurgaon, : Haryana-122001	: POWERGRID NR-II RHR, Plot No-54, : Sama-Savli Road, Vadodara, : Gujarat-390024
Attention	: ED (TBCB)	: Project Incharge (KVAPTL)
Email	: tbc@powergrid.in	: tbc@powergrid.in
Fax. No.	:	
Telephone No.:	0124-2822123	

19.19.3 If to the Nodal Agency, all notices or communications must be delivered personally or by registered post or facsimile or any other mode duly acknowledged to the addresses below:



(i) **Central Transmission Utility of India Limited (Nodal Agency)**

Address : 5th to 10th Floor, IRCON International Tower,
Tower no-1, Plot no -16 , Sector-32, Gurugram,
Haryana :122003

Attention : Mr. Atul Kumar Agarwal

Email : atul_ag@powergrid.in

Fax. No. :

Telephone No.: 9910378059

19.19.4 All notices or communications given by facsimile shall be confirmed by sending a copy of the same via post office in an envelope properly addressed to the appropriate Party for delivery by registered mail. All notices shall be deemed validly delivered upon receipt evidenced by an acknowledgement of the recipient, unless the Party delivering the notice can prove in case of delivery through the registered post that the recipient refused to acknowledge the receipt of the notice despite efforts of the postal authorities.

19.19.5 Any Party may by notice of at least fifteen (15) days to the other Party change the address and/or addresses to which such notices and communications to it are to be delivered or mailed.

19.20 Fraudulent and Corrupt Practices

19.20.1 The TSP and its respective officers, employees, agents and advisers shall observe the highest standard of ethics during the subsistence of this Agreement. Notwithstanding anything to the contrary contained in the Agreement, the Nodal Agency may terminate the Agreement without being liable in any manner whatsoever to the TSP, if it determines that the TSP has, directly or indirectly or through an agent, engaged in corrupt practice, fraudulent practice, coercive practice, undesirable practice or restrictive practice in the Bid process. In such an event, the Nodal Agency shall forfeit the Contract Performance Guarantee of the TSP, without prejudice to any other right or remedy that may be available to the Nodal Agency hereunder or subsistence otherwise.

19.20.2 Without prejudice to the rights of the Nodal Agency under Clause 19.20.1 hereinabove and the rights and remedies which the Nodal Agency may have under this Agreement, if a TSP is found by the Nodal Agency to have directly or indirectly or through an agent, engaged or indulged in any corrupt practice, fraudulent practice, coercive practice, undesirable practice or restrictive practice during the Bid process, or after the issue of Letter of Intent (hereinafter referred to as LoI) or after the execution of the agreement(s) required under Sharing Regulations, the Nodal Agency may terminate the Agreement without being

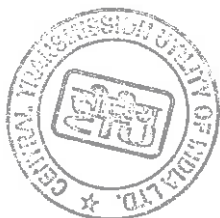

127

Transmission Service Agreement

liable in any manner whatsoever to the TSP. Further, the TSP & its Affiliates shall not be eligible to participate in any tender or RFP issued by any BPC for an indefinite period from the date such TSP is found by the Nodal Agency to have directly or indirectly or through an agent, engaged or indulged in any corrupt practice, fraudulent practice, coercive practice, undesirable practice or restrictive practices, as the case may be.

19.20.3 For the purposes of this Clause 19.20, the following terms shall have the meaning hereinafter respectively assigned to them:

(a) **“corrupt practice”** means (i) the offering, giving, receiving, or soliciting, directly or indirectly, of anything of value to influence the actions of any person connected with the Bid process (for avoidance of doubt, offering of employment to or employing or engaging in any manner whatsoever, directly or indirectly, any official of the BPC who is or has been associated or dealt in any manner, directly or indirectly with the Bid process or the LoI or has dealt with matters concerning the RFP Project Documents or arising there from, before or after the execution thereof, at any time prior to the expiry of one year from the date such official resigns or retires from or otherwise ceases to be in the service of the BPC, shall be deemed to constitute influencing the actions of a person connected with the Bid Process); or (ii) engaging in any manner whatsoever, whether during the Bid Process or after the issue of the LoI or after the execution of the RFP Project Documents, as the case may be, any person in respect of any matter relating to the Project or the LoI or the RFP Project Documents, who at any time has been or is a legal, financial or technical adviser of the BPC in relation to any matter concerning the Project;

(b) **“fraudulent practice”** means a misrepresentation or omission of facts or suppression of facts or disclosure of incomplete facts, in order to influence the Bid process;

(c) **“coercive practice”** means impairing or harming, or threatening to impair or harm, directly or indirectly, any person or property to influence any person’s participation or action in the Bid process;

(d) **“undesirable practice”** means (i) establishing contact with any person connected with or employed or engaged by the BPC with the objective of canvassing, lobbying or in any manner influencing or attempting to influence the Bid process; or (ii) having a Conflict of Interest; and

(e) **“restrictive practice”** means forming a cartel or arriving at any understanding or arrangement among Bidders with the objective of restricting or manipulating a full and fair competition in the Bid process;

19.21 Compliance with Law:

Despite anything contained in this Agreement but without prejudice to Article 12,

Central Transmission Utility of India Limited

73

Khavda V-A Power Transmission Limited



128

Transmission Service Agreement

if any provision of this Agreement shall be in deviation or inconsistent with or repugnant to the provisions contained in the Electricity Act, 2003, or any rules and regulations made there under, such provision shall be deemed to be amended to the extent required to bring it into compliance with the aforesaid relevant provisions as amended from time to time.

Central Transmission Utility of India Limited

74

Khavda V-A Power Transmission Limited

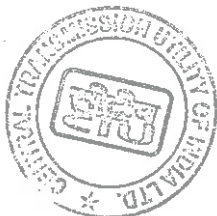

Transmission Service Agreement

IN WITNESS WHEREOF, THE PARTIES HAVE CAUSED THIS AGREEMENT TO BE EXECUTED BY THEIR DULY AUTHORISED REPRESENTATIVES AS OF THE DATE AND PLACE SET FORTH ABOVE.

1. For and on behalf of TSP

[Handwritten Signature]
.....

[Signature, Name, Designation and Address]

2. For and on behalf of[Insert name of the Nodal Agency]

[Handwritten Signature]
.....

JASBIR SINGH
Executive Director
CENTRAL TRANSMISSION UTILITY OF INDIA LTD.
(A Wholly Owned Subsidiary of
Power Grid Corporation of India Ltd)
(A Government of India Enterprise)
Plot No.-2, Sector-29, Gurgaon- 122 001 (Haryana)

[Signature, Name, Designation and Address]

WITNESSES:

1. For and on behalf of

: BPC

[Handwritten Signature]
.....

[Signature]

Nikhil Goel, AM (CS)
.....

[Insert, Name, Designation and Address of the Witness]

2. For and on behalf of

: Nodal Agency

Kamal Kumar Jain
.....

[Signature]

[Insert Name, Designation and Address of the Witness]

KAMAL KUMAR JAIN
Senior General Manager
CENTRAL TRANSMISSION UTILITY OF INDIA LTD.
(A Wholly Owned Subsidiary of
Power Grid Corporation of India Ltd)
(A Government of India Enterprise)
Plot No.-2, Sector-29, Gurgaon- 122 001 (Haryana)



SCHEDULES

Central Transmission Utility of India Limited

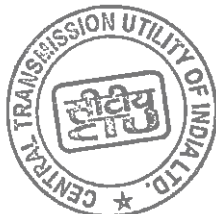

76

Khavda V-A Power Transmission Limited

A handwritten signature in black ink, appearing to be a stylized 'A' or similar character.



181

Schedule: 1

Project Description and Scope of Project

Scope of the Project:

Sl. No.	Scope of the Transmission Scheme	Scheduled COD in months from Effective Date
1	Establishment of 6000 MW, \pm 800 kV KPS2 (HVDC) [LCC] terminal station (4x1500 MW) along with associated interconnections with 400 kV HVAC Switchyard*. 6000 MW, \pm 800 kV KPS2 (HVDC) [LCC] Terminal station	48 months for Bipole-1 (19/11/2028) and 54 months for Bipole-2 (19/05/2029)
2	Establishment of 6000 MW, \pm 800 kV Nagpur (HVDC) [LCC] terminal station (4x1500 MW) along with associated interconnections with 400 kV HVAC Switchyard* 6000 MW, \pm 800 kV Nagpur (HVDC) [LCC] terminal station	
3	\pm 800 kV HVDC Bipole line (Hexa lapwing) between KPS2 (HVDC) and Nagpur (HVDC) (1200 km) (with Dedicated Metallic Return) (capable to evacuate 6000 MW with overload as specified)	
4	Establishment of 6x1500 MVA, 765/400 kV ICTs at Nagpur S/s along with 2x330 MVAR (765 kV) & 2x125 MVAR, 420 kV bus reactors along with associated interconnections with HVDC Switchyard*. The 400 kV bus shall be established in 2 sections through 1 set of 400 kV bus sectionaliser so that 3x1500 MVA ICTs are placed in each section. The bus sectionaliser shall be normally closed and may be opened based on Grid requirement. <ul style="list-style-type: none"> • 765/400 kV, 1500 MVA ICT-6 (3 on each 400 kV section) (19 single phase units including one spare unit) • 765 kV ICT bays- 6 Nos. • 400 kV ICT bays- 6 Nos. (3 on each section) • 330 MVAR 765 kV bus reactor-2 Nos. • 125 MVAR 420 kV bus reactor-2 Nos. (one on each section) • 765 kV reactor bay- 2 Nos. • 765 kV line bay- 4 Nos. • 400 kV reactor bay- 2 Nos. (one on each section) • 400 kV Bus sectionaliser - 1 Set 	



Transmission Service Agreement

Sl. No.	Scope of the Transmission Scheme	Scheduled COD in months from Effective Date
	<ul style="list-style-type: none"> • 110 MVAR, 765 kV, 1-ph reactor (spare unit for line/bus reactor) - 1 No. <p>Future Provisions at Nagpur:</p> <p>Space for:</p> <ul style="list-style-type: none"> • 765/400 kV, 1500 MVA ICT- 4 (1 on 400 kV bus section-II & 3 on future 400 kV bus section-III) • 765 kV line bays along with switchable line reactors – 10 Nos. • 765 kV Bus Reactor along with bay: 2 No. • 765 kV Sectionalizer bay: 1 -set • 400 kV line bays along with switchable line reactor – 12 Nos. • 400 kV Bus sectionalizer- 1 Set • 400/220 kV ICT along with bays -9 Nos. (3 Nos. on 400 kV bus sections II & 6 Nos. on future bus section-III) • 400 kV Bus Reactor along with bay: 4 No. (1 each on 400 kV bus sections I & II and 2 on future 400 kV bus section-III) • 220 kV line bays: 16 Nos. • 220 kV Sectionalization bay: 2 set • 220 kV BC & TBC: 3 Nos. • 80 MVAR, 765 kV, 1-ph reactor (spare unit for line reactor)-1 	
5	LILO of Wardha – Raipur 765 kV one D/c line (out of 2xD/c lines) at Nagpur	
6	<p>Installation of 240 MVAR switchable line reactor at Nagpur end on each ckt of Nagpur – Raipur 765 kV D/c line</p> <ul style="list-style-type: none"> • 240 MVAR, 765 kV switchable line reactors- 2 Nos. (at Nagpur end) • Switching equipment for 765 kV line reactor- 2 Nos. (at Nagpur end) • 80 MVAR, 765 kV, 1-ph reactor (spare unit for line reactor)-1 No. 	



Transmission Service Agreement

* The 400 kV interconnections (along with all associated equipment/ bus extension, etc.) between HVDC & HVAC switchyards shall be implemented by the TSP

Note:

- i. The 2x1500 MW poles shall emanate from 400 kV bus section 1 of KPS2 and terminate at bus section 1 of Nagpur. Similarly, the other 2x1500 MW poles shall emanate from 400 kV bus section 2 of KPS2 and terminate at bus section 2 of Nagpur.
- ii. HVDC System will be designed considering 100% power reversal capability. The rated power transmission capacity as well as the rated transmission voltage shall be defined and guaranteed at the rectifier end of the AC yard.
- iii. TSP of KPS2 shall provide space for the establishment of the HVDC system as per above scope.
- iv. The implementation timeframe: 48 months for Bipole-1 (2x1500 MW) and all other elements except Bipole 2 (2x1500MW) and 54 months for Bipole-2 (2x1500 MW) (from date of SPV acquisition).

Project Description

Govt. of India has set a target for establishing 500 GW capacity from non-fossil energy sources by 2030. In this direction, in December 2020, Hon'ble Prime Minister laid the foundation stone of the world's largest renewable energy park in Gujarat's Kutch. This 30 GW capacity hybrid renewable energy park is being built along the Indo-Pak border at Khavda using both wind and solar energy and is expected to play a major role in fulfilling India's vision of generating 500 GW of non-fossil generation capacity by 2030.

Out of 30GW, 15GW RE capacity is expected to come up by 2024-25 and balance by 2026-27 timeframe and beyond. Transmission system for evacuation of up to 22GW power from Khavda RE Park is already under implementation/bidding in 4 phases as per details below:

Phase	RE Capacity (GW)	Status of Transmission System
I	3	<p><u>Under Implementation:</u></p> <ul style="list-style-type: none"> • KPS1 S/s and KPS1 – Bhuj 765kV D/c line: Awarded to Adani Transmission Ltd. with SCOD of Jan'24. • KPS2 S/s: Awarded to POWERGRID with SCOD of Dec'24. • KPS1 – KPS2 765kV D/c line: Awarded to Megha Engg with SCOD of Jan'25.
II	5	<p><u>Under Implementation:</u></p> <ul style="list-style-type: none"> • KPS3 S/s & KPS3 – KPS2 765kV D/c line: Awarded to



134

Transmission Service Agreement

		<p>POWERGRID with SCOD of Dec'24.</p> <ul style="list-style-type: none"> • Khavda Ph-II Part A - Awarded to Adani Transmission Ltd. with Expected SCOD of March'25. • Khavda Ph-II Parts B & C – Awarded to POWERGRID with Expected SCOD of March'25. • Khavda Ph-II Part D – Awarded to TPGL(RTM) with Expected SCOD of March'25.
III	7	<p><u>Under Bidding:</u></p> <ul style="list-style-type: none"> • Agreed in 11th NCT – MoP Gazette issued in Apr'23 and expected SCOD is Aug'25.
IV	7	<p><u>Under Bidding:</u></p> <ul style="list-style-type: none"> • Agreed in 14th NCT – MoP Gazette issued in Sep'23 and expected SCOD is Jan'26.

The Phase-V scheme has been planned to enable evacuation of additional 8 GW RE power from Khavda RE park.

The subject scheme (under Part A) includes establishment of Nagpur 765/400kV S/s through LILO of Wardha – Raipur 765 kV one D/c line (out of 2xD/c lines) and establishment of 6000 MW, ± 800 kV HVDC [LCC] terminal stations (4x1500 MW) at KPS2 and Nagpur along with ±800 kV HVDC Bipole line between KPS2 (HVDC) and Nagpur (HVDC).

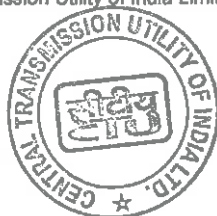

135

Specific Technical Requirement of 6000 MW (4x1500 MW), ± 800 kV HVDC
[Type: Line Commutated Converter (LCC)]

1. **General**

The proposed HVDC link shall be ± 800 kV, 6000MW HVDC line between Nagpur and KPS2 using Dedicated metallic return and consist of Bipole-1 (3000 MW) & Bipole-2 (3000 MW). Bipole-1 shall consist of Pole-1 (1500 MW) & Pole-2 (1500 MW) and Bipole-2 shall consist of Pole-3 (1500MW) & Pole-4 (1500 MW). **The HVDC terminals shall be implemented with 100% power reversal capability.**

The system shall generally conform to the requirements of CEA (Technical Standards for Construction of Electrical Plants and Electric Lines) Regulations 2022, CEA (Safety requirements for construction, operation and maintenance of electrical plants and electric lines) Regulations, as amended from time to time and any other Rule/Regulations/Standard/Guidelines as mentioned in the Transmission Service Agreement.

2. **Abbreviations**

The following terminology shall apply at various places of this specification:

DMR:	Dedicated Metallic Return
DMRTB:	Dedicated Metallic Return Transfer Breaker
DPS:	Dynamic Performance Studies
ESCR:	Effective Short Circuit Ratio
FAT:	Factory Acceptance Tests
HMI:	Human Machine Interface
HVAC:	High Voltage Alternating Current
HVDC:	High Voltage Direct Current
HVRT:	High Voltage Ride Through
IBR:	Inverter Based Resources
Id:	Direct current (any defined value)
LCC:	Line Commutated Converter
LI/SI:	Lightning Impulse/Switching Impulse
LVRT:	Low Voltage Ride Through
MTDC:	Multi-terminal HVDC transmission system
MVU:	Multiple Valve Unit
NBS:	Neutral Bus Switch
NGBS:	Neutral Ground Bus Switch
PCC:	Point of Common Coupling
PMR:	Pole Metallic Return
PMRTB:	Pole Metallic Return Transfer Breaker
RPC:	Reactive Power Control

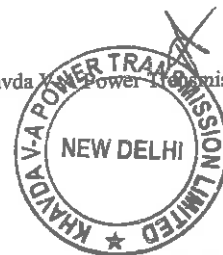

SAS:	Substation Automation System
SCADA:	Supervisory Control and Data Acquisition
SCR:	Short Circuit Ratio
SSTI:	Sub-synchronous Torsional Interaction
TSP:	Transmission Service Provider
Ud:	Direct voltage (any defined value)
VDCOL:	Voltage Dependent Current Order Limit

3. Definitions

Bipole: A pair of 2 poles which are connected to opposite polarities (positive and negative). For power transmission in one Bipole, two such pairs (consisting of 4 converters) are required.

Forward Power flow direction: Active power transmission from KPS2 HVDC to Nagpur HVDC.

Inverter: HVDC terminal which is receiving the power.

MVU (Multiple Valve Unit): An assembly of a number of valves mounted into a single structure (these include components mounted on the valve structure, e.g., saturable reactor, surge arrester) which may be considered part of the valve.

PCC (Point of Common Coupling): The connection point between the HVDC and the power system at which performance requirements are defined.

Rectifier: HVDC terminal which is sending the power.

Reverse Power flow direction: Active power transmission from Nagpur HVDC to KPS2 HVDC.

Thyristor level: 'Thyristor level' comprises a single thyristor, control, protection, monitoring, auxiliary power and voltage grading components which make up a single voltage level within the valve.

Valve: Complete operative controllable or non-controllable valve device assembly, normally conducting in only one direction (the forward direction), which can function as a converter arm in a converter bridge

Valve Module: 'valve module' is the smallest assembly, comprising a number of thyristor levels, voltage grading and damping components, valve reactors, etc. from which the valve is built up and which exhibits the same electrical properties as the complete valve, but only a portion of the full voltage capability of the valve.

4. Design Consideration

Central Transmission Utility of India Limited

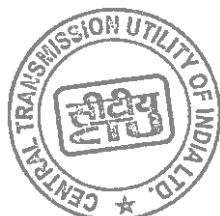

137

Khavda V-A Power Transmission Limited



Transmission Service Agreement

The salient technical features for HVDC terminals shall be as follows (Table 1):

Table 1

Sl. No.	Item Description	Parameters
1.	Rectifier station location (Forward direction power)	KPS2 HVDC (Gujarat) [If the power direction is reversed, KPS2 will become inverter]
2.	Inverter station location (Forward direction power)	Nagpur HVDC (Maharashtra) [If the power direction is reversed, Nagpur will become rectifier]
3.	Rated DC voltage (1.0 pu)	±800 kV DC at Rectifier HVDC Pole Bus
4.	Rated power (1.0 pu)	6000MW at Rectifier DC Bus
5.	Minimum DC Power	150 MW (Single pole operation)
6.	AC system frequency	Nominal 50 Hz
7.	Fault Current level AC system	63 kA for 1 sec for KPS2 63 kA for 1 sec for Nagpur
8.	Minimum Short circuit level (MVA) at 400 kV KPS2 (both rectifier and inverter operation)	Sec-I: 25600MVA & Sec-II: 19800MVA (with IBR)# Sec-I: 17600MVA & Sec-II: 13800MVA (without IBR)# <i>(Considering outage of 2x1500MVA ICTs on each section, with 400kV bus sectionaliser kept open)</i>
9.	Minimum Short circuit level (MVA) at 400 kV Nagpur (both rectifier and inverter operation)	18000MVA# <i>(Considering outage of 2x1500MVA ICTs, with 400kV bus sectionaliser kept closed)</i> Sec-I: 12700 MVA# and Sec-II: 12700 MVA#



Transmission Service Agreement

Sl. No.	Item Description	Parameters
		(Considering outage of 1x1500 MVA ICT on each section, with 400 kV bus sectionaliser kept open)^
10.	Overload requirement	1.1 pu for 2 hours 1.2 pu for half hour 1.33 pu for 5 seconds
11.	Reverse power rating	100% of rated Forward direction power transfer ratings (with 1.33 pu overload for 5 second only).
12.	Reduced voltage	80% of rated DC voltage [Applicable for both power flow directions
13.	Converter transformer	Single phase two winding design
14.	Thyristor valve	Water cooled
15.	Valve cooling system	Dry type design
16.	HVDC control system*	Main + hot standby
17.	HVDC protection system*	Duplicated Protection
18.	Auxiliary supply source	Supply sources tapped from 33 kV side of 2 nos. of 765/400/33 kV transformer (1500 MVA) at KPS2 and 33 kV tertiary of 2 Nos. 765/400/33 kV ICT at Nagpur. Each auxiliary power shall be fetched from both separate sources of the 33 kV auxiliary supply in station.
19.	DC Harmonic filter	Minimum One DC filter for each pole at each HVDC terminal station



139



Transmission Service Agreement

Sl. No.	Item Description	Parameters
20.	AC Network Impedance	Relevant CIGRE/IEC document shall be used for the Network harmonic impedance together with information in PSSE network files provided by CTU.
21.	Negative sequence voltage (fundamental frequency)	1% for Design of equipment 1.5% for rating of equipment
22.	HVDC line online fault locator for pole lines	One No. per pole at each terminal station [when not integrated with Control & Protection System]
23.	HVDC paralleling and de-paralleling switch	As per Requirement
24.	Smoothing reactor on DC bus	As per requirement but not less than 33% of total milli Henry (mH) required for each pole, shall be provided on DC pole bus
25.	Blocking filter	As per requirement
26.	Reliability and Availability Design Targets	As per Table 10
27.	Station Loss evaluation criteria	Methodology as per IEC 61803 and Target figures stated in Table 10
28.	System Grounding	Solidly grounded

**TSP can provide integrated Control and Protection system as well, meeting functional requirements.*

§ The power reversal in HVDC links shall be possible from the maximum active power transmission capacity from KPS2 HVDC to Nagpur HVDC to the maximum active power transmission capacity from Nagpur HVDC to KPS2 HVDC within 60 minutes. HVDC System shall be capable of at least three Power reversals in every 24 hours.

#The values of short circuit level are based on available network topology and generated parameters for various network elements.



Transmission Service Agreement

400 kV Bus sectionalizer at Nagpur end shall remain normally closed. However, the System shall be designed in such a way that it is possible to transmit full rated power (including overload as per S.No.-10 of Table-1) even with 400 kV Bus sectionalizer open and considering outage of 1x1500 MVA ICT on each section at the Nagpur end.

The criteria for the design and control of the network shall be as follows:

- 400 kV AC bus voltages shall normally be within $\pm 5.0\%$ of nominal voltage (400 kV). Bus voltages outside this range may occur from time to time and may exist for long periods due to abnormal loads and/or contingencies. Unless otherwise stated, all equipment shall be rated to operate safely for AC voltages between 360 kV- 440 kV at the converter stations.
- AC system frequency shall normally be within 48.5 Hz to 51 Hz and the HVDC system shall operate without any restrictions on power transfer. However, equipment shall be rated for 47.5 Hz to 52.5 Hz band.
- For calculating reactive power exchange and filter performance, the 400 kV AC voltage variations to be taken shall be from 380 kV to 420 kV and the frequency shall be from 49.0 Hz to 50.5 Hz. Frequency range for AC/DC filter rating shall be 48.5 Hz to 51 Hz.

5. Environmental Data

The following environmental data shall be considered (Table-2):

Table 2

Sr. No.	System data	Nagpur	KPS2
1	Max/min Ambient temperature (dry bulb one-hour average) Max dry bulb 24 hr average	50 deg C max 0 (Zero) deg C min 40 deg C	50 deg C max 0 (Zero) deg C min 40 deg C
2	Relative Humidity (% , max)	100	100
3	Average annual rainfall	As per rainfall map of IMD	As per rainfall map of IMD
4	Iso-keranic level	As applicable	As applicable
5	Wind Zone	As per National Building Code 2016	As per National Building Code 2016



141

Sr. No.	System data	Nagpur	KPS2
6	Seismic Level	As per Seismic zone of the site	As per Seismic zone of the site
7	Altitude above sea level	<1000 m	<1000 m
8	Pollution level (IEC 60815)	Heavy	Heavy

Note: The TSP shall ensure specific measures for protection against airborne salt at KPS-2 for all the equipment as well as ventilation system

6. System Performance

The HVDC system shall be designed to meet all performance requirements and shall be compatible to existing system. The HVDC system shall not cause instability to the AC existing Network. Also, it shall not cause adverse effects to other HVDC system in vicinity, solar based generation plants (near KPS2) as well as Generating Units. This shall be verified by stability, multi infeed and Sub Synchronous Resonance (SSR) studies and any other Study required, if applicable. Steady State, dynamic, HVRT, LVRT, Harmonic and flicker performance requirements as per applicable Rule/Regulations/Standards/Guidelines as per TSA shall be applicable.

The rated power transmission capacity shall be defined and guaranteed at Rectifier DC Bus and rated transmission voltage shall be defined at the rectifier DC bus. In the calculation of the power transmission capability, the most unfavourable combination of control and measurement tolerances shall be considered and without redundant cooling and thyristors. All components of the transmission system shall be rated to meet the requirements given in this section and other requirements specified elsewhere under these Specifications.

HVDC system performance and rating requirements for high voltage equipment and other critical equipment shall be determined taking into account the extreme values of environmental and AC and DC system parameters as applicable for performance/ rating requirements given under these Specifications and manufacturing and measuring tolerances.

7. Overload Requirements

Table 3

Rectifier DC bus KPS2 for Bipole	Duration	Redundant cooling	Converter bus voltage
1.1 pu	2 hours	Available	380 kV - 420 kV
1.2 pu	0.5 hour	Available	380 kV - 420 kV



1.33 pu	5 seconds	Not available	380 kV - 420 kV
---------	-----------	---------------	-----------------

These overloads would be available for bipole mode of operation in forward power direction. For monopolar mode of operation or unbalanced mode of operation, equipment need not be upgraded due to additional voltage drop in DMR path, instead TSP will indicate available power rating.

(a) Two Hour Over Load

The HVDC system shall be capable of operating for two hours at transmitted power levels at least 10% (ten percent) higher than the maximum continuous ratings for the specified nominal system conditions and environmental conditions;

If the AC bus voltage at Rectifier or Inverter is below 380 kV, the overload transmitted power capability may be progressively reduced to maintain the direct current at the maximum value obtained with the AC bus voltage at 380 kV.

It shall be permissible to apply the two-hour overload power at least once in every 12 hours period. The overload capability may be for an extended duration upto a maximum of twelve hours, in one or more intervals, in which case the product of power and time shall not exceed (i) 6600 MW-Hrs for each Bipole and (ii) 13200 MW-Hrs for both Bipoles in a 12-hour period and with the maximum limit of power maintained at 1.1 pu in every converter.

(b) Half an Hour Overload

The HVDC system shall be capable of operating for half an hour at transmitted power levels of at least 20% (twenty percent) higher than the maximum continuous ratings and immediately following the five seconds overload conditions.

(c) Five Seconds Overload

The HVDC system shall be capable of operating at least for five seconds at transmitted power levels 33% greater than the maximum continuous ratings and at specified nominal system and environmental condition. It shall be assumed that the AC bus voltages do not change when this overload is applied.

The five second overload rating shall be achieved without tap changer operation, and the pole voltage may be reduced during the period of this overload.

It shall be permissible to apply the five second overload power once in any five-minute period. This five second overload shall also be permitted during operation at the two-hour overload rating with redundant coolers and heat exchangers available for service. Power greater than the two-hour overload shall form the start of five second overload period.

(d) It may be noted that 1.2 pu and 1.1 pu overload ratings are for power compensation following loss of a healthy converter as well as for transmission of excess power during peak generation with all converters in service upto 1.1 p.u.(i.e. 6600 MW) and 1.2 p.u (i.e. 7200 MW) . However, the purpose of 33% overload is for system stability, power modulation and dynamic ride through of the system as a whole and can be initiated with the initial system conditions of 1.0 pu Bipolar or 1.1 pu overload Operation.



142

- (e) For calculations, maximum line resistance shall be taken at a maximum conductor temperature of 85°C with minimum wind velocity and maximum solar radiation while for minimum line resistance the conductor temperature shall be taken as 0 degree C.

8. DC Voltage:

The nominal direct voltage at the Rectifier converter station DC line terminal shall be ± 800 kV relative to neutral. This voltage shall be maintained within ± 20 kV by tap changer and Firing angle control for all power flows (i.e. minimum to overload [1.1 p.u power rating]) with balanced current between the poles/converters for all AC bus bar voltages between 380 kV and 420 kV and for all AC system frequencies between 49.0 Hz and 50.5 Hz.

In any monopolar operation, or three converter operation (unbalance operation of one Bipole in parallel with a monopole) the Pole Voltage to Ground may be decreased by equivalent Voltage drop in DMR line.

In the event that the AC system voltage is below 380 kV down to 360 kV, the DC line voltage may be correspondingly reduced.

If the AC system voltage at Rectifier or Inverter is above 420 kV but not exceeding 440 kV, the DC line voltage to ground may be increased but shall not exceed 820 kV at Rectifier. Higher than normal firing angles can be utilized to restrict the DC line voltage under these conditions and the equipment should be adequately rated.

The above references to DC pole voltages shall be interpreted as extremes and shall not be exceeded due to measurement error, tap changer control dead band, tolerances in the manufacture or in the control system, or for any other reason.

9. Reduced DC Line Voltage

The HVDC system shall be capable of operating continuously at a nominal pole voltage of 640 kV relative to neutral at rectifier DC bus in bipolar as well as in monopole modes. Rectifier station shall be capable of transmitting not less than 4800 MW in bipolar link and 2400 MW in each Bipole. Redundant cooling may be in service. The pole voltage shall be within 20 kV of the above provided that the AC bus voltage is below 400 kV.

It shall also be possible to set DC voltage reference between 640 kV to 800 kV in either pole in the steps of 10 kV by the operator action.

Power levels in this voltage range shall be as permitted by the main circuit rating of the equipment. However, reduced voltage attempt by DC line protection shall directly first achieve 640 kV. The reduced voltage may be achieved by a combination of tap changer and firing angle control. Reduced voltage operation shall be possible to be ordered by operator from either station even with telecom out of service. The change from normal to reduced voltage operation and vice versa shall not require a valve group shutdown or reduction in power below that achievable with the reduced voltage. It shall be possible to start the transmission in reduced voltage mode.

10. Converters Operating modes

The HVDC equipment at both Converter Stations shall be designed and rated to operate with



144

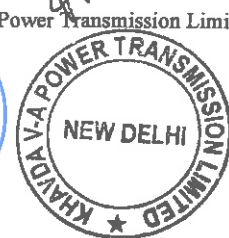

different DC power orders. Necessary facilities shall be provided to permit these modes of operation and to allow the individual Pole power and/or current orders and/or voltage to be set as per below.

Each Pole/Bipole shall be capable of transmitting power including overloads and for the system short circuit levels specified in this specification. The minimum operating modes are as follows:

- (a) Balanced/ unbalanced bipolar operation
- (b) Monopolar operation with Pole Metallic Return (PMR)
- (c) Monopolar operation with Dedicated Metallic Return (DMR) [DMR1 or DMR2 or DMR1 parallel to DMR 2] mode or DMR [DMR1 or DMR2 or DMR1 parallel to DMR 2] in parallel with PMR
- (d) Three converter operation at each HVDC terminal end: These 3 converters could be any 3 out of 4 converters at terminal station.
- (e) Any converter of one polarity at one HVDC terminal can operate with any converter of same polarity at the other end (upto the overload capacity of converters)

All above operating modes shall also be available for reverse power and reduced voltage operation.

11. System Studies

The TSP shall be responsible for overall system engineering and detailed design of all elements, systems, facilities and equipment. The TSP shall have to carry out following studies for this purpose for both directions of power flow. The TSP may note that the following list is only indicative and if any other studies, calculations etc. are required the same shall have to be done by TSP.

Central Transmission Utility of India Limited



90

Khavda V-A Power Transmission Limited



145

Transmission Service Agreement

- (a) Main circuit parameters
- (b) Transient Current Requirement and Short circuit studies
- (c) Thermal Rating Study for Key Equipment
- (d) Studies for Overvoltage Protection and Insulation co-ordination for AC and DC systems
- (e) AC, DC Harmonics and Power Line Carrier (PLC)/Radio Interference (RI) filter design, rating and performance;
- (f) Temporary overvoltage (Fundamental Frequency Temporary Over Voltage-FFTOV) and Ferro Resonance Overvoltage Studies;
- (g) AC and DC Transient overvoltage Study, surge arrester stress;
- (h) Runback and run up studies;
- (i) AC breaker Transient Recovery Voltage (TRV) and rate of rise of recovery voltage (RRRV) studies;
- (j) DC High Speed Switch Requirement Study
- (k) Overload study;
- (l) AC equivalent study;

The equivalents to be prepared for peak load, light load and extremely weak (minimum SCR) network scenarios. The dynamic network equivalent shall be prepared with full machine models having exciters, governor- turbine, generators, stabilizer models instead of voltage source models, upto a minimum of two buses away. These dynamic equivalent networks shall be used in PSCAD DPS, Real Time Digital Simulator (RTDS) DPS, with actual control & Protection panels.

- (m) DC Commutation switch requirements;
- (n) Load flow, stability, modulation and frequency controller design study;
- (o) Electrical interference study (RI and PLC);
- (p) Reliability and availability study;
- (q) Audible noise study;
- (r) Loss calculations/study
- (s) Studies for deciding the operational logic & sequences considering Dedicated Metallic Return Conductor (DMR) operation and Metallic return with pole conductor, in case of monopolar Operation
- (t) Impact of parallel AC lines
- (u) Real Time Simulator-based studies for testing of actual HVDC Controls (Factory Acceptance Test or Factory System Test)

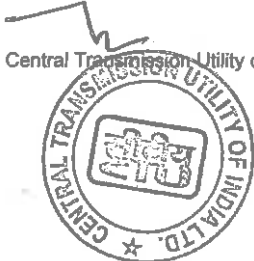

- (v) AC/DC system interaction studies.
- (w) Interaction studies between this LCC HVDC and other HVDC stations including VSC based ± 500 kV, 2500 MW Converter near KPS-3, LCC based 2500 MW converter at Mundra terminal, LCC based 1500 MW converter at Chandrapur (near Nagpur), LCC based 1000 MW back-to-back converters at Chandrapur (near Nagpur), STATCOMs (planned/execution) which are electrically coupled nearby and other nearby Inverter Based Resources (IBR) and Inverter based Load.
- (x) Studies to determine the requirements for communication between the converter stations and remote Load Despatch Centres (LDCs).
- (y) Studies for designing the Equipment for Dedicated Metallic Return Conductor (DMR) operation and metallic return with pole conductor, in case of monopolar operation up to rated power (including overload).
- (z) Sub synchronous Resonance & Self Excitation Studies

These studies to demonstrate that the HVDC system does not excite the torsional modes of oscillations and self-excitation of the generators and Sub- synchronous Resonance in thermal/gas turbine generators near Converter Stations under all defined system operating conditions. The study shall demonstrate that the HVDC system has positive damping for all sub synchronous torsional modes of the generators.

- (aa) Studies of DC Current flowing through Windings of Converter Transformers
- (bb) AC line and other bays protection co-ordination studies
- (cc) DC over voltage studies
- ..
- (dd). Station earthing.
- (ee) LVRT, HVRT, harmonic resonance and other dynamic studies.
- (ff) Studies for the Control, Protection and Communication Systems

The study reports shall include the following study results:

- (i) Dynamic Performance Study including the RE Resources near Converter Stations DPS studies shall be done with DPS model of Khavda VSC HVDC, DPS model of Khavda Pooling station and RE Park in vicinity
- (ii) Hierarchical Structure of the Control and Protection
- (iii) Redundancy of the Control and Protection Systems
- (iv) DC Power and Current Control Modes and Features
- (v) Switching Sequences and interlocking
- (vi) AC & DC System Protections

For each protection, the report shall include the following:

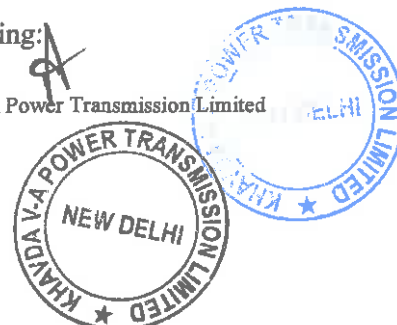

147

Transmission Service Agreement

- a) Purpose of the protection
- b) Principle of protection operation
- c) Required accuracy of measuring signals
- d) Fault detection and coordination between the DC controls and the protection and AC protection.
- e) Consequences of protection operation, such as DC control and sequence control initiated at both converter stations
- f) Redundancy of protection and operation of backup protection
- g) Detailed calculations of the protection settings together with limiting fault cases and/or criteria that determines these settings.
- h) Description of the applicable protection in case of loss of telecommunication.

(vii) Reactive Power Control

The study shall include at least the following:

- a) Reactive power control principles for converter operation during steady state and transient conditions
- b) Reference variable control criteria
- c) Criteria for switching of reactive power sub banks
- d) Operator operation, including control and monitoring features
- e) Equipment description, emphasizing reliability/availability and maintenance features
- f) Validity checking of signals
- g) Switchover and control feature between AC voltage/reactive power controls

(viii) Telecommunication Interface Requirements

(ix) Station Control and SCADA System

(x) Control for Converter Transformer Tap changer

(xi) Additional Control Study

The report, as applicable shall include the studies of the following control modes with the AC network condition of KPS2 and Nagpur and actual performance of converter equipment and possible fault condition being taken into account,:



148

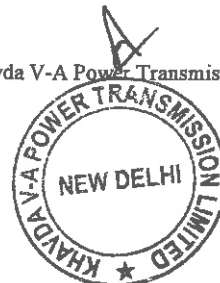

- a) Power ramp down
- b) Power ramp up
- c) Damping of sub-synchronous oscillations
- d) Abnormal AC voltage and frequency control
- e) Supplementary modulation signals

(xii) Multi Infeed Interaction Study with nearby HVDC System

(xiii) Commutation failure performance study

Impact of the commutation failure & cascading commutation failure (if expected) on the inverter based resources (IBR) & associated AC network shall also be included in this study.

(gg) Any other studies as deemed necessary by TSP.

TSP shall carry out necessary studies for performance under this RfP considering the 400 kV Bus-sectionalizers at KPS-2 (S/s) and Nagpur (S/s) in both open and closed condition.

The load flow and dynamic file shall be provided to the TSP in PSS/E 34 or newer version format. This will include maximum and minimum fault contribution from conventional generation and IBRs considering full power, reduced DC voltage power and other network scenarios which can lead to the highest possible dynamic overvoltage variations. Necessary Generic Models for IBRs or modelling assumptions shall also be provided for studies requiring the same. Conventional generator, lumped mass model and controller models in vicinity shall also be provided. For sharing User Defined Models (UDMs) TSP and Solution Providers will be required to abide with the statutory requirements of the UDM provider if required.

In case of absence of detailed models of nearby inverters and 2500 MW VSC HVDC, the harmonic distortions shall be considered as per the relevant CEA Regulations. The impedance of RE Park at the Pooling station PCC will be provided to the TSP. The rest of the network may be modelled by the harmonic impedance and the rating and performance studies shall be done accordingly. Harmonic impedance shall take into account all contingencies in base file, N-1, N-2 and other PSS/E scenarios for network for full power and reduced DC power. PSS/E files are provided based on the data available at the time of issuance of RfP. TSP is required to validate the data before carrying out simulation. However, clarification, if any, may be sought before the bid submission. CEA/CTU shall endeavour to give clarification to the extent possible. In case of any discrepancy observed/non-availability of data for any of the machines and other control devices, typical values may be used in the studies with the intimation to CEA/CTU

12. Digital Models

TSP shall provide to the CTU the following models of all supplied circuit components and control and protection of the HVDC Systems. The models shall be up to date with all the

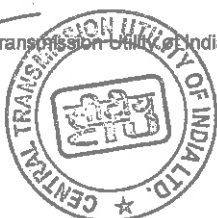

149



design features implemented in the Project.

(a) PSCAD

(b) PSS/E

TSP shall provide both UDM and Generic model for RMS based stability model (in PSS/E V36 or above) and EMT (PSCAD v5 and above). All appropriate control features shall be modelled in the above models and necessary documentation on the theory and use of model should be provided. Further, a generic model, benchmarked to the extent possible to the UDM PSS/E and PSCAD model, shall also be furnished. Generic models can be shared by the CEA, CTU and Grid-India with the concerned stakeholders/external party(ies) e.g. STUs etc. on need basis. For User Defined model, confidentiality shall be maintained by the CEA, CTU and Grid-India. For PSCAD, User Defined model shall be provided by the TSP for which confidentiality shall be maintained by the CEA, CTU and Grid-India. Both UDM (PSCAD and PSS/E) and Generic model (PSSE) shall be provided by OEMs to CEA/CTU/GRID-INDIA without any NDA (Non-Disclosure Agreement).

Data sharing requirements as per Procedure for First Time Charging/Energization (FTC) and Integration of New or Modified Power System Element of Grid Controller of India Ltd. (GRID-INDIA) shall also be done by the TSP. All the requisite data/reports/models including User defined models/documents as required as per the CEA/CTU/Grid India Standards/Guidelines shall be provided by the TSP.

Data sharing format will be subject to the agreement or other statutory requirements mandated by HVDC OEMs, if required.

13. DC power circuit switching requirement:

The TSP shall provide all DC switching devices as per the requirements of this Specification to enable the smooth and efficient operation of the HVDC system.

All disconnectors or isolators which are used to provide isolation for maintenance on any equipment shall have visible breaks. If a visible break is not inherent then an additional separate isolator having a visible break shall be provided.

The equipment arrangement shall be designed to ensure that no single contingency, fault or loss of any piece of equipment can cause or result in a bipolar shutdown or transient reduction in power transfer to less than the rating of one Pole.

High speed switches (paralleling & de-paralleling switches) for converters shall be provided with disconnectors on both sides.

The station layout shall provide safe access to all equipment for service and maintenance. The DC power circuit arrangement shall provide at least the following functions:

- (a) Isolating and grounding Converter Station Pole for maintenance.
- (b) Isolating and grounding either or both DC transmission line Poles for maintenance.
- (c) Isolating and grounding the DMR conductor at the Converter Station for maintenance when operating in bipolar mode with balanced DC currents. All primary equipment, control, protection and measuring equipment necessary to achieve this function

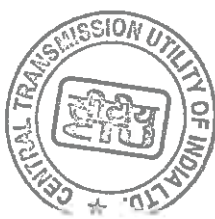

150



shall be provided. All the studies and design engineering necessary for the HVDC System to operate in such modes shall be performed.

- (d) Clearing of a Pole for maintenance without affecting the power flow on the other Pole.
- (e) Switching from DMR to "DMR in parallel with PMR" mode of operation during monopolar operation and back.
- (f) Grounding of the neutral bus through a high-speed switch (NBGS) during bipolar operation balanced current mode.
- (g) Clearing neutral bus fault on one Pole.

14. Insulation co-ordination

- (a) HVDC System shall be suitably protected against Impulses and disturbances external and internal to the system such as switching impulses, lighting impulses, steep front impulses, dynamic over voltages and load rejection (1.2 pu power). The insulation of all equipment shall be properly protected and coordinated with surge arresters and/or surge capacitors. Insulation coordination shall be done keeping in mind the minimum electrical clearances, safety clearances and maintenance clearances as per Switching Impulse Withstand Level (SIWL). Insulation coordination shall be done as per relevant IS/IEC Standards.
- (b) The insulation of the equipment and protection levels of Surge Arresters connected to the converter AC bus bars of the converter stations at both rectifiers and inverter shall be coordinated with the insulation and surge arrester characteristics of the connected AC systems to which the converter stations are to be connected without exceeding the discharge duty of these arresters so as not to overload these existing arresters of the network. Only 336 kV surge arrester (rated voltage) shall be used on AC incoming 400kV line side.
- (c) The tripping action for lines shall be initiated if the fundamental frequency over voltage exceeds 1.1 pu for 5 seconds and if 1.5 pu fundamental frequency voltage persists for more than 100 milliseconds. The HVDC over voltage strategy shall be coordinated with such setting.
- (d) The minimum insulation levels for 800 kV DC to ground shall be as follows:

Table 4

HV Transformer LIWL/SIWL (kV)	Smoothing reactor LIWL/SIWL (kV)	Thyristor Valve Structure LIWL/SIWL (kV)	DC Busbar LIWL/SIWL (kV)
1800/1600	1800/1600	1800/1600	1900/1600

LIWL- Lightning Impulse Withstand Voltage;

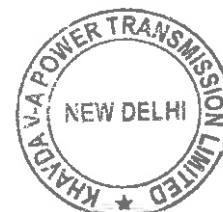

SIWL- Switching Impulse Withstand Voltage

- (e) The ratio of **impulse withstand voltage** to impulse protective level shall be in line with Table 3 of IEC-60071-11.
- (f) The TSP shall carryout insulation coordination studies for the Project. The TSP shall perform all necessary HVDC digital simulator studies and shall keep detailed report(s) on insulation coordination in its record. The TSP shall carry out insulation coordination studies for rating of all arresters supplied for the project, establishing the required insulation level for supplied equipment and the clearances between energized parts and between energized parts and ground. The arrester arrangement and protective levels shall be selected such that, generally, the overvoltages on the AC side are protected by arresters on the AC side, and overvoltages on the DC side are adequately limited by an arrangement of arresters on the DC side. Critical components of the supplied converter equipment shall be directly protected by arresters connected closest to them. The arresters installed shall be rated such that these arresters are not overstressed for all operating modes and configurations. The studies must show that any existing 420 kV equipment including any existing surge arrestors will not be overstressed for all modes of operation and configurations of either Converter Station when HVDC station is extension of an existing AC station.

The report(s) shall detail the characteristics of the surge arresters, energy ratings and shall demonstrate that the selected insulation protective and withstand levels, discharge and coordinating currents, and arrester ratings and discharge capabilities are adequately coordinated and comply with the requirements of this Specification. It shall also detail all insulation and air clearances and leakage distances and shall justify the selected values based on the present Specifications. The report(s) shall include all assumptions made for the study parameters and describe the types of events modeled (i.e. AC and DC faults, valve hall faults, converter valve or control mis-operations, etc.) and identify the decisive cases that establish the insulation design.

(g) **Temporary Over voltages**

The converter valves shall be capable of continuing to operate under the temporary overvoltage conditions specified below, which could occur with the valves deblocked and also that the valves are capable of deblocking under the highest temporary over voltage conditions within 5 (five) cycles of the initiation of a fault or disturbance. Equipment shall be designed for the applicable short circuit ratio and overvoltage arising thereby.

Temporary Overvoltage caused by Bipole link HVDC transmission shall be controlled to 1.4 pu or below. Events caused by other equipment in the AC network shall be controlled within the limits of the capability of the deblocked converter. In case the

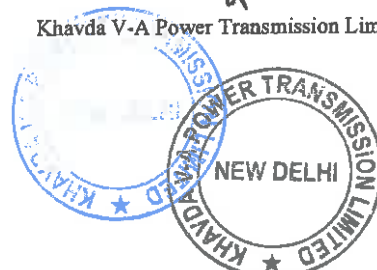
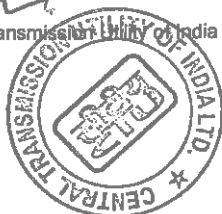

converter is tripped, and not possible to restart within seconds, filter tripping shall be allowed to limit over voltages.

The actual temporary over voltage shall be determined by the TSP but equipment shall be designed for temporary over voltage not less than the values given above. In addition, so as to prevent operation and overstressing of the arresters, the TSP shall limit the temporary over voltages including harmonic, resonant, and ferro-resonant effects on the 400kV AC bus bars so that:

- 705 kV crest phase to ground is not exceeded by more than 3 peaks;
- 565 kV crest phase to ground is not exceeded by more than 10 cycles;
- 510 kV crest phase to ground is not exceeded by more than 20 cycles.

In the calculation of temporary over voltages on the AC side the TSP shall allow for blocking of the complete Bipole(s) from up to the highest steady state transmission capability of the installation. On the DC side the TSP shall allow for the maximum load rejection which could occur and which leaves converter deblocked.

The converter Equipment shall be designed to withstand temporary over voltages corresponding to AC Side which are not less than 1.5 times 400 kV at converter stations with the converter blocked.

The TSP shall provide and commission all equipment necessary to limit the temporary 50 Hz over voltages on the AC bus bars to the levels specified above. The actual temporary overvoltage shall be determined by the TSP but AC equipment shall be designed for temporary overvoltage not less than the values given above.

The connected AC harmonic filter shall be assumed to be that with the highest MVAR applicable to the mode of operation which does not exceed the maximum reactive power exchange with the AC system as specified in this specification.

The converter equipment shall be rated for continued operation under the maximum over voltage conditions to be defined by the TSP taking into consideration the dynamic over voltage profiles as determined by the design studies to be performed by the TSP. Irrespective of the over voltage profile derived by the TSP, the equipment shall be rated to withstand an over voltage according to above figures following deblocking.

DC withstand voltage design of equipment shall take due consideration of the temporary voltage stresses that the respective equipment may be exposed to based on studies of different disturbances as applicable.

Any switching equipment within the scope of supply of the TSP which may be called

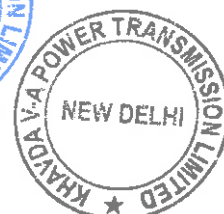

Transmission Service Agreement

upon to operate at this voltage in either a main or backup role shall have the appropriate capability.

HVRT Strategy The HVDC Station shall enter into HVRT mode (exit from continuous operating region) when the Voltage at AC bus i.e. 400 kV side (RMS) is above 1.1 p.u. due to faults/control actions/or any other cause. The HVDC Station shall remain connected to the grid when voltage at the inter-connection point (AC bus), on any or all phases (symmetrical or asymmetrical overvoltage conditions) rises above the specified values given below for specified time:

Over voltage (pu#)	Minimum time to remain connected at POI
$V > 1.50$	Instantaneous trip
$1.50 \geq V > 1.30$	100 ms
$1.30 \geq V > 1.10$	10 sec
$V \leq 1.10$	Continuous

1pu = 400 kV (3 phase RMS voltage at POI)

LVRT Strategy The HVDC Station shall enter into LVRT mode (exit from the continuous operating region) when the Voltage at AC bus i.e. 400 kV side (RMS) is below 0.9 p.u. due to faults/control actions/or any other cause.

The HVDC Station must remain connected to the grid when voltage at the interconnection point (AC bus), on any one, two or all phases (symmetrical or asymmetrical overvoltage conditions) dips up to the level depicted by the thick lines in the following curve:

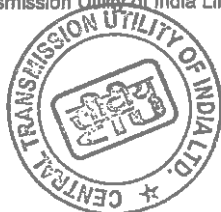

Transmission Service Agreement

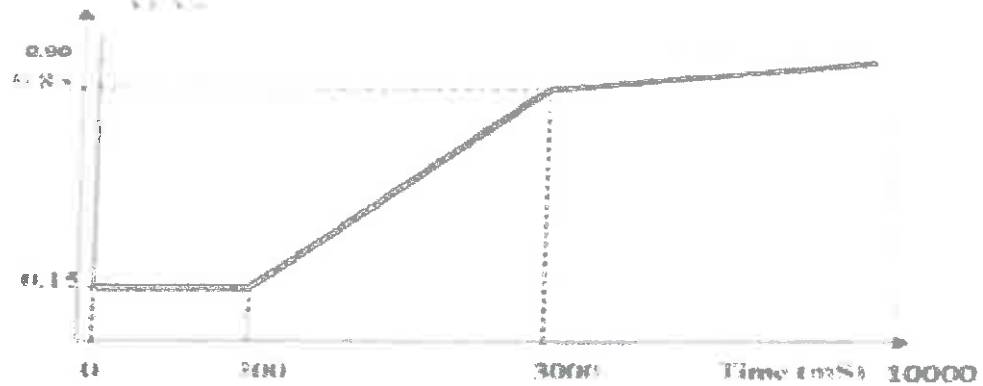

1 p.u. = 400 kV (3 phase RMS voltage at POI)

During LVRT mode, HVDC Station shall withstand all above low voltage conditions. Restoration of voltage shall be said to be achieved when the voltage at PoI settles within +5% of pre fault voltage.

(h) Transient over voltages

In the calculation of transient over voltages the TSP shall consider at least:

- (i) Lightning surges propagating down the AC and DC overhead lines, including direct strike to line conductors and back flashover;
- (ii) Lightning surges due to direct strike within the converter station in the event of shielding failure;
- (iii) Steep fronted waves resulting from flashovers or faults, including those within the valve hall and to ground from the valve windings of the converter transformers;
- (iv) over voltages due to switching of converter transformers, AC filters and shunt capacitors, shunt reactors, 765 kV and 400 kV transmission lines, 765 kV and 400 kV class transformers or other equipment;
- (v) For re-closure of AC filters and capacitor banks, residual voltage on the capacitors shall be considered.
- (vi) The saturation effects of converter transformer due to presence of remnant flux shall also be considered.
- (vii) Application and clearing of single phase and three-phase to ground faults which may be cleared by AC circuit breakers; Possibilities of breaker re-strikes shall also be considered although the breaker should be designed as restrike free.



- (viii) Faults within converter equipment, including control and telecommunication malfunctions;
- (ix) Over-voltages due to blocking of 6 pulse or 12 pulse valve groups with and without bypass pair firing;
- (x) Over-voltages due to DC and DMR line resonance.
- (xi) Uneven distribution of over-voltages, particularly within the converter valves;
- (xii) Commutation overshoot, particularly when operating at higher than normal firing or extinction angles coupled with dynamic over voltage conditions;
- (xiii) Arrester location relative to protected equipment and arrester characteristics.
- (xiv) For determination of maximum transient over voltages at converter bus with a sequence of clearance of three phase /single phase AC bus fault along with blocking of one pole running at overload with appropriate AC filters remaining connected and subsequent protection actions.
- (xv) Continuous commutation failure at the inverter and rectifier valve misfire.
- (xvi) Earth faults and short circuits within the valve halls and on DC filter bus.

(i) Limitation of Overvoltage

Blocking of the converter valves to protect them and other DC side equipment from sustained over voltages appearing on the AC system shall not be permitted. The use of converter valve group controls to limit temporary (dynamic) over voltages shall be permitted provided that the valves and other converter equipment are adequately rated.

(j) Determination of Overvoltage

The TSP shall determine the highest transient and temporary over voltages, which can occur with the equipment parameters selected and with the AC system and DC line as defined in this Specification.

(k) Arrester Protective Levels

The transient over voltages imposed across insulation shall be limited by surge arresters. Dynamic over voltages may also be limited by surge arresters but only if the arresters are adequately rated for such duty.

The discharge current (coordinating current) shall be determined by the TSP appropriate to the arrester location and line & equipment parameters. For arresters connected to the 400 kV AC bus bars, the 8/20 microsecond wave coordinating discharge current shall be 10 kA, 15 kA or 20 kA as appropriate. Where multicolumn arresters are used or where arresters in separate housings are connected in parallel,



unequal sharing of the discharge current shall be considered.

The TSP shall design the converter equipment to withstand a maximum continuous AC system voltage of 440 kV. The calculations for determination of arrester energy requirement shall be based on a maximum pre-fault voltage of 440 kV.

(I) **Lightning shield**

The TSP is responsible for the design of the lightning shield. The system shall also be designed to provide "effective shielding" to ensure that almost no insulation flashover can result from atmospheric discharges striking the overhead shielding.

Effective and adequate lightning protection shall be provided to protect all converter equipment including wall bushings and the Converter Station buildings from damage due to atmospheric discharges and shall ensure that any lightning strikes shall not cause flashover or mal-operation of any equipment which can affect the power transmission capability of the Converter Station.

Central Transmission Utility of India Limited



Khavda V-A Power Transmission Limited

A



15. **Radio Interference (RI), Acoustic Noise (AN) and DC field**

- (a) All the necessary precautions shall be made during HVDC design to ensure that there shall be no mal-operation, damage or danger to any equipment, system or personnel due to electromagnetic or electrostatic interference effects. The converter terminal(s) shall neither damage nor cause mal-operation of the DC control and protection system or the DC tele-control system.
- (b) All the necessary precautions shall be taken in the form of noise suppression techniques, shielding and filtering devices to prevent harmful interference, which may be generated by the converter terminals, with the Power Line Carrier (PLC) systems, Radio communication systems, Television systems, VHF, UHF & microwave radio systems.
- (c) The audible noise shall be limited to the following values for various areas of the converter station and buildings. It is to be demonstrated by calculation and site measurement that the specified sound pressure levels are not be exceeded.

Table 5

Valve hall (in places where long term access is required during normal operation)	90 dBA
Mechanical equipment indoor areas requiring long term access (measured at 2 meter distance)	
Equipment in outdoor areas (measured at 15 meter distance) except converter transformers	75 dBA
Office area*	45 dBA
Control rooms*	45 dBA
Diesel generator (Operating area)	75 dBA
Compressor areas (measured at 2 meter distance)	90 dBA
At the station boundary (Outside wall or fence)	70 dBA

* "Background" noise from the ventilation system.

- (d) For area with permanent access, the total calculated electric field at ground level shall not exceed 20 kV/m excluding space charge in the DC yard. For area with permanent access in DC yard, calculated Ion current density shall be less than 20 nA/m² at ground level.
- (e) Radio Interference (RI)

The TSP shall take the necessary precautions in the form of valve hall and building shielding to meet his own requirements plus the following:

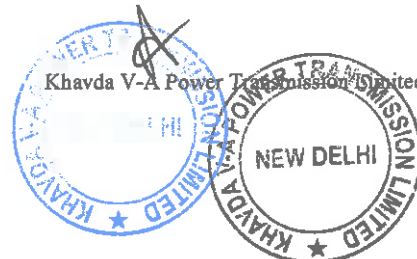
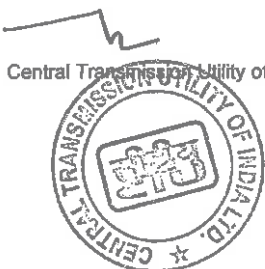

Transmission Service Agreement

- (i) With the Bipole operating at any of the specified operating modes and power levels and within the design range of firing angles, the Radio Interference Level (RIL) from electromagnetic radiation generated by the converter shall not exceed 100 micro volt/m under fair weather conditions at any point outside station fence which are:

500 meters or more from the nearest bus connecting the valve to the converter transformers within the station.

and

at a lateral distance of 30 m for the conductors of any outgoing AC line, HVDC line and electrode line.

This RIL criterion shall be achieved at all frequencies within the range of 150 kHz to 300 MHz.

- (ii) The valve hall design shall incorporate the screening requirements. The use of a mesh screen external to the building, covering all or part of the switchyard shall not be permitted.
- (iii) The shielding shall be designed so that the specified radio interference levels shall not be exceeded assuming any earth resistivity between 10 and 1000 ohm-meter.
- (iv) Maximum radio interference voltage for frequency between 0.5 MHz to 2 MHz at 1.1 times of maximum DC voltage for 800 kV DC system, 266 kV RMS for 400 kV system and 156 kV RMS for 220 kV system and 92 kV RMS for 132 kV system shall be 2500, 1000, 1000 and 500 micro-Volt respectively.

- (f) Television Interference (TVI)

The Television Interference Level (TVIL) shall not exceed 10 micro volts/m at the locations/contour line specified above.

- (g) Interference with Power-Line Carrier Systems

The TSP shall take the necessary precautions in the form of noise suppression techniques and filtering devices to prevent harmful interference from the converter stations to Power Line Carrier (PLC) systems operating on the HVAC transmission line networks connected to each station and also to other power line carrier systems located adjacent to the HVDC bipolar line such that PLC systems shall operate reliably in fair weather conditions. The frequency spectra to be protected for PLC system is 40 kHz to 500 kHz.

16. Dynamic Performance

Central Transmission Utility of India Limited

104

Khavda V-A Power Transmission Limited

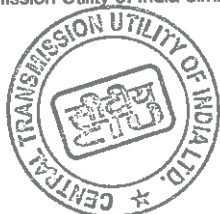

159

- (a) The purpose of dynamic performance design is to determine the control parameters for HVDC system and to ensure that the HVDC system shall have smooth, stable and fast operation for both steady state and transient conditions without adversely affecting the connected AC grid.
- The principal objectives of the design shall include:
- (i) Optimal response of HVDC controls following step change in ordered parameters like DC current, DC voltage, power, etc.
 - (ii) Stable operation of the DC system following major disturbances.
 - (iii) Stabilization of the AC system following major disturbances.
 - (iv) Control of temporary over-voltages and avoidance of self-excitation of the generators.
 - (v) Control of frequency following quasi-static (slow) and fast changes in AC system load / generation at the rectifiers and/ or inverter ends.
 - (vi) Control of power levels depending on the system configuration. Such a control may require AC line load control (ACLLC) and Run Back control features
- (b) The HVDC system shall recover to 90% of the pre-fault DC power transfer level consistently within 120 ms from the instant of fault clearing, without subsequent commutation failure or sustained oscillation for all inverter AC system fault conditions. For all rectifiers AC system fault conditions, the recovery time, to 90% pre-fault power level, shall be within 100 ms from the instant of fault clearing. The TSP shall verify that such response time does not give rise for any risk of AC system instability in any system configuration. If it is in the interest of the overall improved recovery of the AC/ DC system, in such cases the recovery times other than those specified shall also be acceptable, subject to review.
- (c) HVDC should continue operation at reduced power if conditions get outside the voltage, frequency and short circuit capacity ranges specified in system data as much as possible with its inherent capability.
- (d) HVDC terminal Characteristic and Step responses: The control behavior at rectifier and inverter end for a typical HVDC Pole should broadly follow the following characteristics. It may be noted that minor justified variation from the below characteristics due to Parallel operation of Bipoles depending in the Control Strategy shall be acceptable.



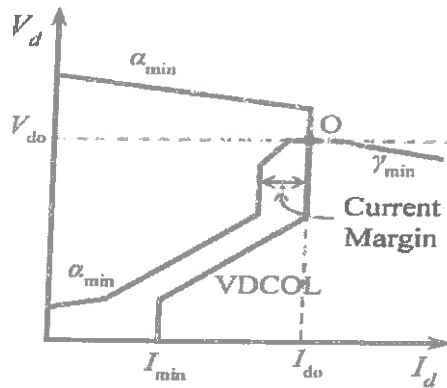
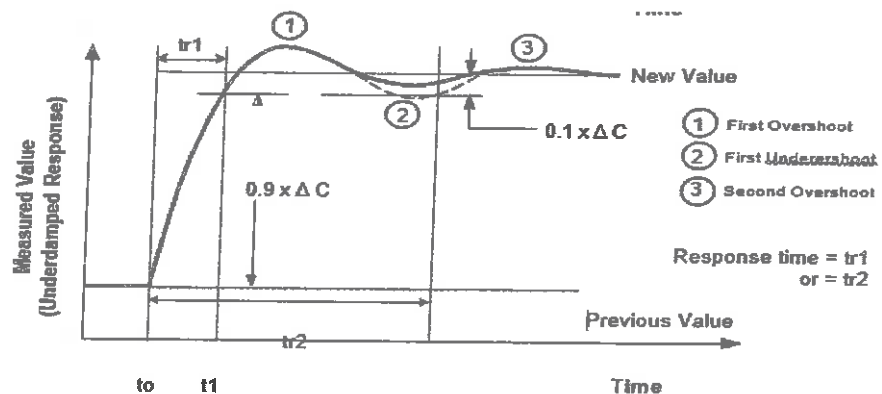

Fig-1- Current margin between rectifier and inverter

The response time ($tr1$) is defined as the time from the initiation of the order change to the time when 90% of the ordered change has been accomplished, subject to the condition that the measured value remains at the new order within a tolerance of +10% of the ordered change at rectifiers DC terminal after the first overshoot. If the measured value exceeds the tolerance of +10% of the ordered change after the first overshoot, then the response time ($tr2$) shall be defined to be the interval from the initiation of the order change to the time when the measured value returns to and thereafter remains at the new order within a tolerance of +10% of the ordered change. The first overshoot shall not exceed 30% of the ordered change and the measured value shall settle at the new order within a tolerance of +2% by the second overshoot. For an over damped system, the response times ($tr3$) is defined as the time from initiation of the order change to the time when 90% of the ordered change has been accomplished. The measured value shall settle at the new order within a tolerance of +2% by four times $tr3$. Step response to changes in power (current) order shall be executed in the following manner:

When the ordered change is *positive*:



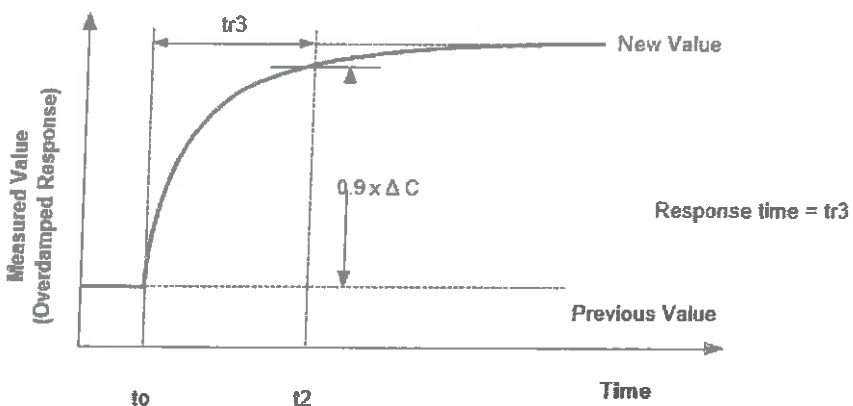

Fig 2- Definition of response to positive step change

When the ordered change is *negative*:

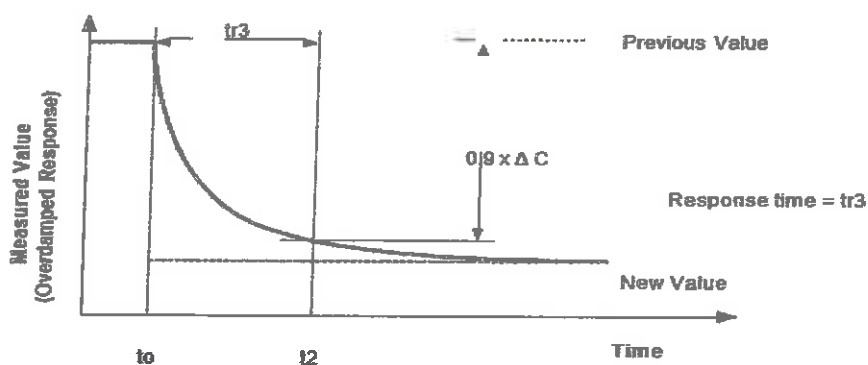
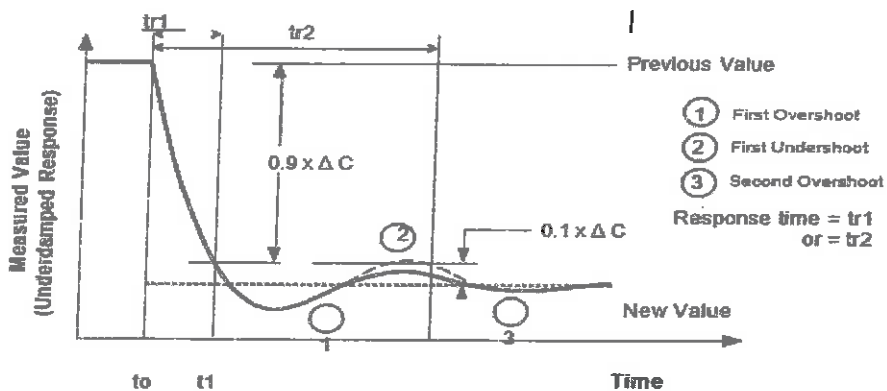

Fig 3- Definition of response to negative step change



(e) **Power Order Step Response**

The HVDC controls, when in power control mode or any other mode where the DC power transfer is controlled, shall respond to maintain the power transfer of the Poles at the ordered or desired level at any power level between minimum and the 30 minutes overload rating of the HVDC system.

When operating at any power order between the minimum and rated power transfer, the DC power controller shall respond to either a step increase or a step decrease in DC power order such that 90% of the ordered change is achieved within 150 milliseconds of the power order change at the rectifier. The TSP shall verify that such response time does not give rise for any risk of AC system instability in any system configuration. If it is in the interest of the overall improved recovery of the AC/ DC system, in such cases the recovery times other than those specified above shall also be acceptable.

(f) **Response to AC Bus Voltage Change**

The TSP shall demonstrate the response of the power controls to sudden changes in AC bus voltages of -5.0% to + 2.0% from its nominal value and ensure that it is stable.

(g) **Power Voltage Instability**

HVDC links operating in constant DC power control and weak AC system conditions can lead to power voltage instability under certain disturbances. To prevent such power voltage instability, the TSP shall provide control measures to prevent AC system collapse during AC system disturbance due to the action of the HVDC control. The TSP may adopt a power reduction or a dynamic gain supervision function in the control system to avoid such instability if the short circuit MVA changes during a particular power transmission level.

17. **Main Circuit Design**

The purpose of Main Circuit design is mainly to determine the operating characteristics and rating of thyristor valves and converter transformers (MVA, tap changer range etc.) It also forms the input for AC Filter and Reactive compensation design. The main circuit arrangement and circuit shall depend on type of HVDC system, Power Transmission requirements, DC Voltage Levels, connected AC voltage levels, Reactive Power requirements and AC & DC Harmonic requirements. The system shall meet various harmonic performance parameters, as specified elsewhere in this specification, on both AC Side and DC side. This requirement along with those given in Table-2, shall be met simultaneously by the AC/DC filters.

18. **HVDC Station Equipment**

The function blocks of converter station are Converter area (converter valves, converter



transformer, smoothing reactor), DC yard (DC filters, DCCT, DC Voltage Divider, PLC filters of DC side, DC pole arresters, Disconnectors and ground switches), AC filter yard, AC yard and auxiliaries. A typical LCC based HVDC station shall consist of the following main equipment:

- (a) Thyristor valves and its accessories e.g. damping and grading circuits, converter cooling system, etc.;
- (b) Converter transformers;
- (c) Smoothing reactors;
- (d) DC filters;
- (e) AC filters (Harmonic filters and PLC filters) and shunt compensation;
- (f) Control and protection of AC and DC side;
- (g) Electrical and mechanical auxiliaries;
- (h) Dedicated Metallic Return (DMR);
- (i) AC switchyard equipment;
- (j) DC switchyard equipment;
- (k) AC & DC Surge arresters;
- (l) AC & DC Measuring instruments;
- (m) Communication system between converter stations (OPGW)
- (n) DC wall bushings
- (o) AC wall bushings (if applicable)
- (p) Auxiliary Power System
- (q) Key interlocking system for valve hall, DC filters, AC filter
- (r) Fundamental frequency blocking filter, if required

19. Converter Station AC Yard, Transformer yard and valve hall

(a) AC commutating bus equipment

The AC circuit breakers, disconnectors, instrument transformers and other switchyard equipment shall be similar to that of the equipment specified under Regulation 46 of Central Electricity Authority (Technical Standards for Construction of Electrical Plants and Electric Lines) Regulations, 2022. The bus rating shall be adopted according to the calculation considering single bus outage. The switching duties of the AC circuit breakers will be decided based on transient over voltage study, insulation co-ordination, AC filters and protection studies.

(b) Dynamic over voltage limiter devices

Converters connected to relatively weak AC systems may cause dynamic over voltages (DOVs) during load rejection / disturbance. The DOV limiter shall consist of parallel arrester elements connected phase to phase or phase to ground and designed to absorb the desired amount of energy during a system disturbance to protect the HVDC system during the HVRT period. The DOV limiter shall be

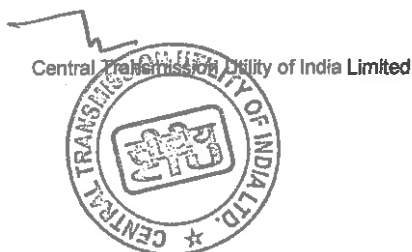

coordinated with recovery of DC system following a disturbance. The requirements of surge arresters shall be based on the insulation co-ordination study in line with relevant standards. The arresters used shall be metal oxide (ZnO) type conforming to relevant standards.

(c) **AC harmonic filters and shunt compensation**

(i) The HVDC converter generates harmonics during the Conversion process and AC harmonic filters shall be used to limit AC voltage distortion due to harmonics to acceptable levels and also to meet the reactive power exchange requirements based on the studies carried out.

TSP shall design the AC filter banks in such a way that it is possible to transmit full rated power even with 400kV bus-sectionalisers open.

(ii) The AC harmonic filters shall be switched in and out by sub-bank circuit breakers in First-in First-out (FIFO) logic to increase lifetime of switchgear. Based on the studies, the reactive power requirement for the terminal and bank or sub-bank size shall be determined such that reactive power exchange with the AC bus shall remain within specified limits.

The permissible limit of voltage fluctuation for step changes which may occur repetitively is 1.5 percent; for occasional fluctuations other than step changes the maximum permissible limit is 3 percent.

(iii) The main filter equipment namely capacitors, reactors and resistors shall comply with the requirements of following IEC.

- A. Capacitors-IEC 60871;
- B. Reactors - IEC 60076-6;
- C. Resistors - IEC 62001/As per owner's specification.
- D. Only air-core reactors shall be used in AC and DC filters for harmonic filtration.

(iv) **Performance Requirement**

The AC filter performance shall be better or equal to as defined by following performance parameters:

- A. The individual harmonic distortion, D_n , shall not exceed 1.5%
Individual Harmonic Distortion, $D_n = V_n/V_1$
- B. The total effective distortion, D_{eff} , shall not exceed 3.0%.
Total Effective Distortion, $D_{eff} = \sqrt{\sum (V_n \cdot 100/V_1)^2}$
- C. The Telephone Influence Factor (TIF) shall not exceed 50.
Telephone Influence Factor, $TIF = \sqrt{\sum (V_n \cdot F_n/V_1)^2}$

Where F_n : Weighting factor for nth harmonic according to EEI

Central Transmission Utility of India Limited



110

Khavda V-A Power Transmission Limited

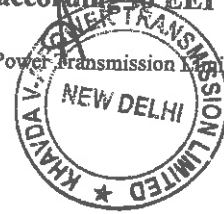

165

publication - 60-68(1960) corrected to 50 Hz operation by graphical interpolation.

- D. The Total Harmonic Distortion, V_{THD} , as defined below shall not exceed 2%:

$$V_{THD} = \sqrt{\sum_{n=2}^{n=40} \frac{V_n^2}{V_1^2}} \times 100$$

'1' refers to fundamental frequency (50 Hz)

'n' refers to the harmonic of n^{th} order (corresponding frequency is $50 \times n$ Hz)

The performance of the AC harmonic filters shall be determined by calculation and shall be based on either as-tested parameters of components or the extreme values of manufacturing tolerances if as-tested values are not available. Performance requirements are to be met for all operating modes. In all Modes of operation, except the reduced DC line voltage modes, the performance requirement shall be met up to rated power with one larger size filter sub-bank and one characteristic harmonic sub-bank (largest) being out of service. All filter banks, sub-banks and branches shall be rated such that the remaining filter components are not overloaded due to detuning or resonance within the filters or between the filters, the generators, and the AC system for any combination of AC system voltage and/or frequency and configuration, or for any operating condition of the converters, or combination thereof, for which the converter valves are capable of continuous operation, or switching time between de-energized and energized states and there is no restriction on the operating power level for any operating conditions with one filter bank outage for power level up to 1.0 pu Short-time and transient conditions as well as operation with discontinuous DC current must be fully taken into account. The system shall also meet the reactive power exchange limits on both the AC side.

(iv)(a) System Contribution

Bidder may suitably model nearby different RE generators as all these generators are required to meet harmonics requirement under "CEA Technical standards for Connectivity to the grid" regulations. Models provided by RE developers will be shared with selected TSP.

At Converter station ac bus, combined converter and static compensator (if used) harmonic currents as calculated for rating purposes shall be increased to allow for harmonic currents from the ac system in following manner:

- (a) At 3rd and 5th Harmonics the increase in current to be allowed shall be calculated based on the assumption that the existing distortion shall be considered as 2% with respect to nominal voltage at converter Bus. This is to be considered for 3rd and 5th harmonic Filter component rating.



- (b) At all even order harmonics and at all other non-characteristic or theoretically cancelled harmonics the increase in current to be allowed shall be not less than 50 (fifty) percent provided that the contribution of the harmonic in question to any rating parameter, in the absence of the above increase, is not greater than 10 (ten) percent of the total harmonic rating.
- (c) At all characteristic harmonics or at any other harmonic which is effectively filtered (i.e. the harmonic contributes more than 10% of the total harmonic rating of a component in the absence of the increase) the increase in current to be allowed shall not be below 20 (twenty) percent.

(v) Power Monitoring Device and Power Quality Recorder: The TSP shall provide one number of Power Monitoring Device and Power Quality Recorder as per IEC 61000-4-30 class-A at suitable location (400 kV AC Bus) at each end of KPS2 and Nagpur Substation for acquisition, visualization, evaluation and transmission of electrical measured variables such as alternating current, alternating voltage, frequency, power, harmonics etc. The acquisition and processing of measured variables and events shall be performed according to the power quality measurement standard IEC 61000-4-30 class-A compatible with IEC 61850 protocol.

(v) Shunt Reactor Banks

Shunt reactors, if required, of suitable size shall be provided to meet reactive power exchange requirements derived from the studies. The shunt reactor must be switched in or out by a circuit breaker. The shunt reactor shall conform to CEA's Standard Specifications and Technical Parameters for Transformers and Reactors (66 kV and above Voltage class). The shunt reactor shall be covered under automatic switching under the reactive power control strategy.

(d) Power Line Carrier (PLC) filtering

PLC filters shall be installed close to converter transformers to mitigate high frequency harmonic currents generated during thyristor switching.

(e) Converter transformers

- (i) The converter transformer shall be designed in accordance with IEC- 60076-57-129. The converter transformers shall be single phase two winding units. The maximum flux density in any part of the core and yoke at the rated MVA, voltage and frequency shall be such that under 10% continuous over voltage condition it does not exceed 1.9 Tesla. The Converter transformer shall be capable of withstanding minimum DC current of 10 A per single phase transformer entering through the neutral.
- (ii) The insulation level for the transformer AC (line side) windings and bushings shall be as given at Regulation 45 of Central Electricity Authority (Technical Standards for Construction of Electrical Plants and Electric Lines) Regulations, 2022 and insulation levels of the valve side windings shall be determined in accordance with studies. The impedance of the transformer shall be determined

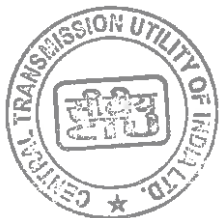

167



as in accordance with studies and variations in impedance shall be as per the requirement of relevant standards.

- (iii) Converter transformers shall be equipped with On Load Tap Changer (OLTC) and Metal Oxide Varistor (MOV) devices shall be provided between tap leads of the OLTC. The OLTC tap steps shall be determined in accordance with the operating strategy of both the converters. The OLTC shall be designed for a minimum 2,50,000 operations without repair or change of any part including oil. The OLTC shall be designed for a contact life of minimum 6,00,000 operations.
- (iv) The requirements of soak pits and firewalls shall be in line with Regulation 46 of Central Electricity Authority (Technical Standards for Construction of Electrical Plants and Electric Lines) Regulations, 2022.
- (v) The converter transformer bushing shall be designed in accordance with IEC-60137/ IEC-65700, as applicable.

20. Thyristor valves and valve cooling system

- (a) The thyristor valve assembly shall be designed and tested as per relevant IEC/IS. The valve shall be designed and protected during operating conditions for various over voltage and over current stresses to which it may be subjected to due to faults occurring in various parts of the station.
- (b) The thyristor valve modules, used for converting AC to DC or vice versa, shall be complete with associated electronic firing system; protection, monitoring & damping system, auxiliaries and cooling system. Twelve pulse scheme shall be used.
- (c) In case of two series converter configuration, a bypass switch shall be provided to bypass any faulty converter and use the remaining series converter at lower DC voltage.
- (d) The thyristor valves shall be water cooled, air insulated and indoor type. The valves shall be either suspended type or floor mounted type depending upon the operating DC voltage and seismic requirements. The Double or Quadruple valve design shall be used depending on voltage level.
- (e) Necessary control and monitoring including tripping of the HVDC system in case of cooling system failure shall be provided.
- (f) The valves shall be placed in the valve hall which shall have a positive pressure over atmospheric pressure and humidity control feature. The pressurization will be maintained by ventilation system.
- (g) No oil immersed part is permitted to be used inside the valve as well as valve hall. The electronic components located within the valve shall be designed to eliminate overheat and arcing. Only components of low flammability, high reliability and

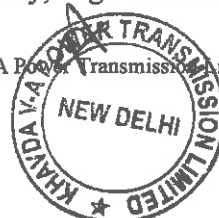
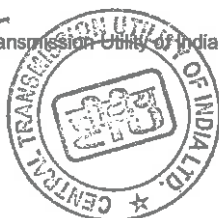

adequate ratings in margins can be used. All thyristor including spare thyristors shall be identical and interchangeable between the converter stations.

- (h) Requisite redundancy shall be kept through a provision of suitable number of spare thyristors in valve modules. The number of redundant thyristors shall not be less than 3.0% of the total number of thyristors in the valve. Status of each thyristor level on the valve while the equipment is in service shall be monitored.

(i) Description of Valve Cooling System:

(i) Fine Water Circuit

The fine water circuit shall consist of a main circuit and a water treatment circuit. The cooling medium in the fine water circuit shall be deionised water with low conductivity.

(ii) Main Water Circuit

The main cooling circuit shall consist of water within the thyristor valves, a de-aeration vessel /venting, pumps and filters.

The main circuit shall be provided with an expansion vessel with level transducers and pressurised with nitrogen, as per requirement of OEM design. The level transducers shall be used for control of the makeup water for the system, if applicable, and for detection of leakages.

There shall be two water pumps. One of the two water pumps shall circulate the 100% water through the main cooling circuit and the water treatment circuit. The other pump shall be included for redundancy purpose. The operation shall be automated and arranged into alternative weeks between these two pumps. Upon failure of the unit in service, the redundant shall be automatically activated.

(iii) Water Treatment Circuit

A part of the main flow shall be circulated in the water treatment circuit. The water treatment circuit shall consist of oxygen removers (if required), ion exchangers and mechanical filter. Sensors shall be provided for measuring conductivity of the water, both in the main cooling circuit and in the treatment circuit at the exit side of the ion-exchanger. The water treatment circuit shall have provision to connect makeup pump and associated valves and strainers. The water pipe for fine water make up shall be connected to main fine water circuit through the water treatment circuit.

(iv) Air Cooled Liquid Coolers

The air-cooled liquid coolers shall cool the water from the thyristor valves. One redundant unit shall be provided by the TSP over and above the quantity required to achieve the operating temperatures for rated power.

All the stations shall have dry type coolers. Each cooler shall consist of cooling fans with separated air channels.

Suitable protection against corrosion, oxidation etc. shall be provided for all cooling equipment.

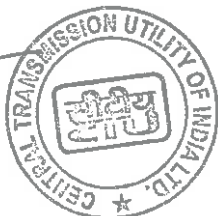

(v) **Mechanical Design**

The cooling system shall be pre-fabricated. There shall be three main parts:

- fine water pump unit;
- air cooled liquid coolers;
- piping.

The fine water pump unit shall be mounted on a frame and shall be placed in the valve cooling room. The air-cooled liquid coolers shall be placed outdoors, near to the valve cooling rooms. The piping shall be especially designed stainless steel and adapted to the station building.

(vi) **Control Equipment**

The valve cooling control equipment shall be specially designed for application to the cooling system for thyristor valves. There shall be two computer-based control systems such that either both are in ACTIVE mode, or when one system is in ACTIVE mode the other system shall be in ACTIVE STANDBY mode. Each computer-based system shall be self-checking and an automatic changeover to the other system shall take place in the case of failure of the active system.

(vii) **Design Criteria for the Cooling System**

Features to ensure high reliability, proper function and prolonged life time for the cooling system and thyristor valves shall be included. The following main components shall be supplied with redundancy in order to increase the availability:

- main circulation water pump
- air cooled liquid cooler (with one additional standby cooler)
- bypass valves
- transducers
- nitrogen bottles, if applicable

(viii) **Design Cooling Requirements**

Separate cooling system shall be designed to cool the heat generated in each 12-pulse group of thyristor valves for converter stations.

Cooling system shall be capable to operate and guarantee the design temperature specified steady state and overload conditions, up to max specified design dry bulb ambient temperature. Redundant Uninterrupted Power System/drive for valve cooling for each pole shall be rated for 2 minutes.

(ix) **Ambient conditions**

Ambient Conditions are specified in Table 2 of the specification.

(x) **Materials**

The materials in contact with the cooling water as well as for manufacturing of



the air-cooled liquid cooler shall be selected in order to minimize the risk of corrosion.

(xi) Measure Against Water Leakage

The design of the valve cooling system shall be made to minimise leakages. The following precautions shall be taken to minimize the risk of water leakage from the system:

- choice of water pipe joint
- number of water pipe joints in the system shall be kept as low as possible, particularly in the thyristor valves;
- velocity of de-ionized water in the pipes and in the thyristor heat sinks shall be kept low
- water circulation within the pipes shall be free from trapped air bubbles

(xii) Valve Cooling Control and Monitoring

The valve cooling control systems shall be redundant and be equipped with an integrated data collecting unit that is connected to the station sequential event recorder system.

(xiii) Cooling Capacity Control

The water temperature to and from the thyristor valves are used as an input to the cooling capacity control.

In order to avoid condensation at the pipe lines within the thyristor valves the inlet fine water temperature shall be kept in an appropriate range.

(xiv) Protections

The following protections/monitoring shall be included:

- Temperature of the water from the valves
- Temperature of the water to the valves
- Water flow through the valves
- Water level in the expansion vessel
- Conductivity of the water from the water processing unit
- Conductivity of the water in the main circuit
- Pressure in the expansion vessel, if required
- Pressure in the nitrogen bottle, if required.

(xv) Leakage Detection

There shall be three leakage detection methods used in parallel by the cooling control system. These methods can, depending on the nature of the leakage, generate trip of the converter and cooling system. However, one of the methods of leakage detection shall generate a leakage alarm if volume of leakage exceeds the reference volume, during the last 24 hours.

Besides these detection methods alarms for frequent make up and for long

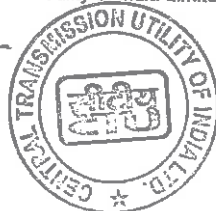

make up when automatic make-up of cooling water is used, generated by the cooling control programme shall be provided. The total schematic of valve cooling system with valve position, flow, temperature, make up details, conductivity, pump running etc shall be made available to the SCADA system of HVDC terminal.

21. Converter Station DC Outdoor Yard

(a) The DC yard shall comprise of equipment such as HVDC bushings, smoothing reactors, DC filters, DC current and voltage measuring instruments and switchgear, surge arrester, insulators, clamps and connectors. DC Yard at Nagpur end shall be outdoor yard. However, at KPS-2 the DC yard shall be indoor with following specifications.

(i) The indoor DC yard building shall be constructed adjacent to the valve hall. Suitable arrangements shall be made for O&M and replacement of the equipment. The floor of the indoor DC yard shall have a heavy-duty floor slab suitable for movement of heavy equipment.

(ii) The indoor DC yard shall be a ventilated hall containing DC yard equipment connected to ± 800 kV HV pole bus

(b) The specific creepage distance (corresponding to highest DC voltage) for DC yard and other areas shall be maintained as follows:

Table 6

Insulator type	Under light and medium pollution	Under heavy and very heavy pollution
Indoor porcelain or composite insulators for valve hall (other than valves) and indoor smoothing reactor area (if any)	20 mm/ kV	
Indoor DC Yard (other than smoothing reactor)	30 mm/ kV	
Thyristor Valves	14 mm/ kV	
Outdoor porcelain insulators or bushings with RTV coating	50 mm/ kV	60 mm/ kV
Outdoor composite insulators or bushings	50 mm/ kV	

Note: Specific creepage distances less than 50 mm/ kV but not less than 45mm/ kV can be accepted for outdoor silicone rubber bushings due to manufacturing limitations and for HVDC equipment requiring necessary internal/ external insulation co-ordination. However, specific creepage distance less than 50 mm/ kV and flash distance less than 12 mm/ kV shall not be acceptable for outdoor jointed bushing.

The base voltage applicable for calculation of valve arrester creepage distance shall be:



172



$$U_{creepage} = \sqrt{\left(\frac{1}{3} + \frac{\sqrt{3}}{8\pi}\right) * CCOV}$$

Where, CCOV: Crest value of Continuous Operating Voltage

(c) **DC wall bushing**

DC wall bushing shall be designed as per IEC-65700. DC wall bushings, used for electrical connection between the equipment inside the valve hall and the outdoor DC yard shall be of polymer housing as per relevant standards. All bushings inside the valve hall including HVDC wall bushing shall be dry type/SF₆ gas filled or combination of both. There shall be no oil filled component inside valve hall.

(d) **Smoothing Reactor**

The smoothing reactor shall be designed as per IEC-60076-6. The smoothing reactor shall be of air core type. The reactors shall comply with relevant standards and shall have successfully passed DC tests as per their application. The smoothing reactor may be divided between pole and neutral for DC voltage above 500 kV. Each converter station shall be provided with one spare coil of smoothing reactor with all fitments, hardware & accessories. Minimum, four nos. of insulators of each type for smoothing reactors shall be provided as spare.

For the design of smoothing reactor, the Si factor has to be within the limits (0.22 < Si < 1) where Si factor is defined as

- Si = $U_{dn} / L_d * I_{dn}$
- U_{dn} = Nominal HVDC Voltage level per pole
- I_{dn} = Nominal HVDC Current
- L_d = Total DC side inductance = L_{dr} + 3.5 L_{tr};
- L_{dr} = Smoothing Reactor inductance
- L_{tr} = Converter transformer inductance

The smoothing reactor shall be designed for Class H for inter turn insulation as per IEC 60085, however, the maximum allowed hot-spot temperature rise shall be limited to one class lower i.e. Class F insulation.

(e) **DC Voltage and Current Measuring Devices**

The DC voltage and DC Current measuring equipment shall be installed at each pole. This equipment can be optical type or conventional type. The DC measuring equipment at pole and neutral bus shall be suitably located based on the control philosophy and different protection zones such that complete pole and neutral equipment are protected. The details of DC Measuring Equipment shall be as per 'Appendix- C.1'.

Central Transmission Utility of India Limited



118

Khavda V-A Power Transmission Limited

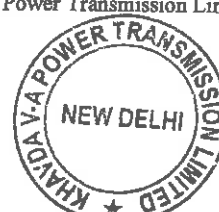

173

(f) **DC Filters**

Adequate numbers of DC harmonic filters shall be provided in DC yard to limit harmonic voltages present on the DC lines (pole lines and DMR line). However, minimum one No. DC filter per pole per station shall be provided. Common DC Filter for parallel poles are not acceptable.

The design shall be based on passive DC filters. The DC Filters shall consist of Low order filters, Harmonic Filters and High Frequency Filters as per the requirement of project specific studies. The main filter equipment like capacitors, reactors and resistors shall comply with the requirements of relevant IS/IEC standards/ CIGRE documents. A fundamental frequency series blocking filter shall be provided, as per requirement. The required switches shall be provided. It shall be possible to connect and isolate a single DC filter arm without causing any reduction in transmitted power on the affected Pole. The calculation of DC filter performance and rating shall be based on values of components, detuning, and harmonic voltages and currents. The TSP shall use "Three Pulse Model" or EMTDC model or equivalent for calculating performance and rating of DC filters.

There shall be no limitation on the energization of the DC filter arms by reason of either ambient temperature, frequency, initial mistuning or DC voltage within the ranges defined in this Specification. The DC filter components shall not become overloaded due to detuning or resonance within the DC filter or between the DC filter arms and the HVDC circuit, or the DMR, for any combination of conditions for which the converters are capable of continued operation.

TSP shall ensure that fundamental and 2nd harmonic resonance and adverse amplification does not occur on DC side. A parallel low order (2nd Harmonic) DC Filter shall be provided across each converter of each station. Earth resistivity along the DC line route will be considered as 250 ohm-m.

DC filter Performance:

The individual harmonic current (I_n) at any harmonic shall not exceed the value which could cause mal-operation of the HVDC system control and protection equipment supplied. The maximum equivalent disturbing current (I_{eq}), up to rated power in forward power direction, without any filter outage, for balanced bipolar and monopolar mode with metallic return or Dedicated Metallic Return (DMR) modes of operation shall be as follows:

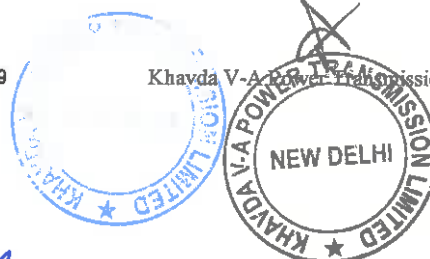

Table 7

Operating Mode	Ieq
Balanced bipolar operation	1500 mA
Monopolar mode with metallic or DMR mode	2200 mA

The equivalent disturbing current includes not only the harmonics which flow in the DC Pole conductors and DMR lines but also the harmonics which are induced into the ground wires of the DC transmission line.

Mutual impedance calculation algorithms require that the ground wires be “eliminated” for this configuration; however, as specified herein, the current flow in the ground wires must be eventually taken into account in the calculation of equivalent disturbing current.

In Bipolar operation, the equivalent disturbing current shall be the psophometric weighted residual current of all harmonics of fundamental frequency from the 2nd to the 60th (i.e. 100-3000 Hz) according to the following formula:

$$I_{eq}(x) = \sqrt{[I_{eC}(x)^2 + I_{eS}(x)^2]}$$

Where,

- $I_{eq}(x)$ is the equivalent disturbing current in milliamps (mA) psophometrically weighted at any point along the transmission corridors specified herein
- $I_{eC}(x)$ is the magnitude of the RSS equivalent disturbing current component due to harmonic voltage sources at KPS2 (mA)
- $I_{eS}(x)$ is the magnitude of the RSS equivalent disturbing current component due to harmonic voltage sources at Nagpur Converter Station (mA)
- x denotes the relative location along the transmission corridors.

The equivalent disturbing current at any point along the corridor due to harmonics from either KPS2 or Nagpur Converter Stations shall be calculated as follows:

$$I_e(x) = \sqrt{\sum_{n=1}^{n=60} \{I_r(n, x) * P(n) * Hf\}^2}$$

Where,

$I_r(n, x)$ is the magnitude of the equivalent residual rms current at each harmonic

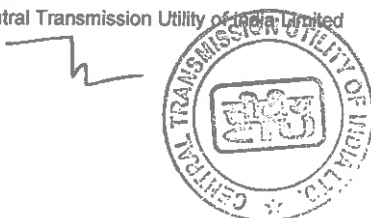

Transmission Service Agreement

in milliamps

(*n*) is the psophometric weighting at harmonic "n" as per Consultative Committee for International Telephony and Telegraphy (CCITT)

n denotes the harmonic number.

Hf is the coupling factor which represents the normalized frequency dependent effects of typical coupling impedances to open wire circuits. The coupling factor *Hf* will be assumed as per table below:

Table 8

Frequency (Hz)	Coupling Factor (<i>Hf</i>)
40-500	0.70
600	0.80
800	1.00
1200	1.30
1800	1.75
2400	2.15
3000	2.55
3600	2.80

As defined above, all harmonics up to the 60th shall be included in the calculation of equivalent disturbing current. The equivalent disturbing current shall be based on a "worst consistent set" of harmonic voltages at either end of the line.

The "worst consistent set" is defined as that set of harmonic driving voltages which could occur at any particular operating condition which results in the highest value of equivalent disturbing current that could occur for a period of longer than ten minutes.

A particular operating condition is defined in terms of:

- a) The mode of operation, i.e. bipolar or monopolar in any specified mode of operation.

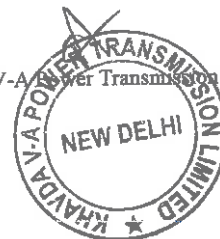

- b) The DC voltage anywhere within the normal range for the mode of operation.
- c) Reduced DC voltage operation on both Poles and reduced DC voltage on one Pole with the other Pole at nominal DC voltage.
- d) The commutating reactance anywhere within the guaranteed range.
- e) The firing angle anywhere within the range applicable to the mode of operation as defined above which shall include firing angles associated with reactive power control and AC filter and reactive power bank switching.
- f) Worst case induced voltage from any parallel lines.
- g) The converter AC bus voltages anywhere within the normal range specified.
- h) The maximum 50 Hz negative phase sequence voltage of 1.5% for achievement of performance limits.
- i) The DC current anywhere within the range applicable to the mode of operation.
- j) Ambient temperature as defined in Table 2.
- k) Differences in the smoothing reactor harmonic impedances of the Poles

DC filter rating

The rating of the DC filter components shall be based on the assumption that the per pole harmonic voltage is individually maximized at each harmonic for any particular operating mode, and the filter component currents due to the harmonic voltages at the terminals shall be assumed to add as RSS (Root Sum Squared) at each harmonic.

For the rating of the DC filter components, it shall be assumed that any one DC filter arm can be out of service in any converter Pole. The DC filters shall be rated for any loading up to the inherent continuous overload capability and short-time overload capability for all operating modes. The possible impact of reduced voltage operation and increased reactive absorption on the ratings of the DC filters shall also be considered.

Short time and transient conditions as well as operation with discontinuous DC current must be fully taken into account. Due allowances shall be made for possible current amplification resulting from resonances between the arms of the DC filters. In the calculation of the impedance of the DC transmission system when used for calculation of DC filter component rating, $\pm 10\%$ tolerance in the respective line length shall be included. AC system voltage and frequency variations as functions of duration specified in Table 2 shall be allowed in the calculation of harmonic voltages and DC filter detuning. In addition, capacitor unit or element failures appropriate to the duration for which the DC filter has to remain connected, shall be allowed for in the calculation of DC filter detuning.

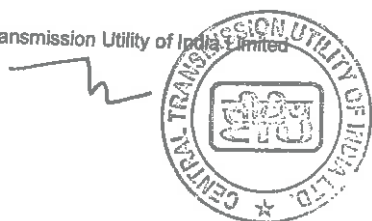

(g) **Surge Arrester**

Surge arresters shall be gapless Metal Oxide arresters and shall be designed and tested as per relevant IS/IEC. The arresters shall be designed to absorb the desired amount of energy during a system disturbance and shall be coordinated with recovery of DC system following a disturbance as applicable.

Arresters at appropriate places may be provided as per requirement. However, the HVDC main arresters typically found in a HVDC System are as follows:

- (i) Valve Arrester
- (ii) Bridge Arrester
- (iii) DC Line Arrester
- (iv) DC Neutral and DC Filter Arrester
- (v) Converter Transformer and AC Filter Bus Arrester
- (vi) DMR line arresters
- (vii) Smoothing Reactor Arrester (if applicable)
- (viii) DC Neutral Switch Arresters
- (ix) DC pole bus arrester
- (x) Converter transformer primary neutral arrester

(h) **Fundamental frequency blocking filter:**

A fundamental frequency blocking filter may be installed to block the 50 Hz induced current in DC line in order to minimize the risk of converter transformer saturation due to possible induced fundamental frequency current from parallel AC lines

This induced current usually results from AC side second harmonic positive sequence voltage and from AC lines running parallel to DC line. The TSP shall consider any possible inductive and capacitive coupling between these lines.

For design purpose, 50 km of parallel un-transposed 765KV AC Double Circuit line and 50 km of parallel un-transposed 400KV AC Double circuit line within a radial distance of 70 m to be considered by the TSP to consider any possible inductive and capacitive coupling between the lines. The parallel section of AC lines shall be considered to be located at a point that results in maximum fundamental frequency current at each converter station.

Such a filter is formed of capacitor, reactor, resistor and arrester. Internal arrangement of these components is left to designer but the overall filter should offer significant impedance to 50 Hz current flowing in DC circuit. Blocking filter reactor shall be designed for Class H for inter turn insulation as per IEC 60085, however, the maximum allowed hot-spot temperature rise shall be limited to one class lower i.e. Class F

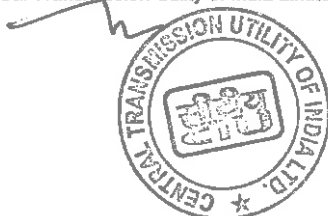

178



insulation. The reactor may preferably have similar design as smoothing reactor to share common spare. The AC/DC/PLC/RI reactor shall be designed for Class F insulation as per IEC 60085, however, the maximum allowed hot-spot temperature rise shall be limited to one class lower i.e. Class B insulation.

(i) **DC commutation switches:**

These switches are required for commutating the DC current from one path to the other. They comprise of Dedicated Metallic Return Transfer Breaker (DMRTB), Pole Metallic Return Transfer Breaker (PMRTB), Neutral Bus Grounding Switch (NBGS). High Voltage High Speed (HVHS) switch and Neutral Bus Switch (NBS) shall also be provided suitably at both ends in all the poles.

22. Dedicated Metallic Return (DMR)

The neutral current return path for bipolar configuration or monopolar configuration shall be via a Dedicated Metallic Return (DMR) conductor connecting both converter terminals.

23. Control and Protection System

It shall be demonstrated that the HVDC control system is stable under all operating conditions and cannot excite oscillations, such as sub-synchronous oscillations, between the HVDC and AC system. The control system shall be tuned for optimal overall performance for all conditions and configurations of the AC system. The details of operator Control and Monitoring are mentioned in 'Appendix C.2'.

It shall also be demonstrated, by applying system faults and step responses in current order and power order during the factory acceptance testing (FAT), that the as-built control system does not excite low order harmonic resonance(s) in the AC system and/or between HVDC and AC systems for any system configuration.

The performance of the integrated DC and AC systems shall also be demonstrated using an EMT-type program (such as PSCAD) in order to validate the system performance requirements. In the DPS program, all the HVDC protections shall be modelled. All feeders in the ac converter bus should have the required protections modelled for DPS studies with network equivalent. DPS studies shall be done with DPS model of Khavda VSC HVDC, DPS model of Khavda Pooling station and RE Park in vicinity. DPS models shall be provided for the VSC HVDC and Khavda Pooling station including RE park shall be provided to TSP.

Software based controls and protection shall be used to permit flexibility in effecting modifications. Protection and controls shall be duplicated for reliability. The control & protection shall provide fast controllability of the HVDC system.

(a) Control System:

- (i) The control system shall have redundancy with hot standby. Transfer of controls from Active Control system to Hot standby control system shall be seamless and there shall be no power interruption during this transition. Outage of one control



179

Transmission Service Agreement

system or part thereof, shall not result in any power reduction.

- (ii) The control shall be designed to give fast, stable and proper response to normal control actions as well as during disturbances such as AC & DC faults.
- (iii) DC converter terminals shall be either manned by operator or controlled by remote operation of SCADA system. The control system hierarchy shall be as follows:
1. Master Control
 2. Station/Bipole Control
 3. Pole/ Converter Control
 4. Valve Control
- (iv) The HVDC Station/Bipole shall have control features (as and when established by system design) including but not limited to the following:
1. Reactive power controller
 2. Current and power controller
 3. Frequency controller
 4. Power modulator, pole power compensation. The modulator, if required, shall have feature which shall provide positive damping of AC network oscillations over the range of frequencies considered during system studies.
 5. Sub Synchronous Resonance (SSR) Damping Controller (if required) based on studies.
- All necessary studies shall be carried out to ensure that the DC system shall not excite the mechanical, electromechanical or other natural frequencies of the nearby region generators and turbines under any operating mode. It shall be demonstrated by studies that the nearby generators shall not be adversely affected by the HVDC system, particularly with regard to Sub Synchronous Oscillation (SSO)/Sub Synchronous Resonance (SSR) and harmonic injection and self-excitation. Sub Synchronous Damping (SSD) Controller shall be provided for converter stations near Generating stations.
6. Run back/Run up controller (10 points) with provision to be linked to Special protection Scheme (SPS) of System Operator
 7. AC system stability function, such as power swing damping function
 8. RE Park Sub synchronous control interaction, Temporary and Transient over-voltages, harmonic interactions, stability, HVRT, LVRT etc. studies,
 9. Interaction studies among various HVDC links and STATCOMs (planned/ execution) which are electrically coupled nearby but not limited to e.g. VSC

Central Transmission Utility of India Limited

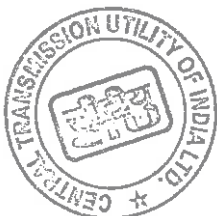

125



180

Khavda V-A Power Transmission Limited



Transmission Service Agreement

based ± 500 kV, 2500 MW converter near KPS-3; LCC based 2500 MW converter at Mundra (about 180 km from Khavda) terminal, LCC based 1500 MW converter at Chandrapur (near Nagpur), LCC based 1000 MW back-to-back converters at Chandrapur (near Nagpur), STATCOMS as per following table:

Sr. No.	Capacity of STATCOM	Name of Substation
1	± 300 MVar	KPS-1 (Section-I)
2	± 300 MVar	KPS-1 (Section-II)
3	± 300 MVar	KPS-3 (Section-I)
4	± 300 MVar	KPS-3 (Section-II)
5	± 200 MVar	Boisar-II (Section-I)
6	± 200 MVar	Boisar-II (Section-II)
7	± 300 MVar	Navsari(New)

10. The TSP shall study all interaction aspects between these converter stations, STATCOMs and devise control strategies to ensure that no adverse interaction takes place among the above stations during steady state and fault recovery. Various fault cases for the purpose of this study shall be finalized by TSP during detailed engineering.

(11) The HVDC system shall conform to the performance requirements specified herein. It shall be designed to optimally co-ordinate all aspects of its controls to ensure safe and reliable operation without adversely affecting the connected AC system and shall assist the latter following disturbances. The performance requirements shall be met under all specified ambient conditions, modes of operation, AC system conditions and other parameters as given under these specifications. Any other Controller as deemed required for stable HVDC system operation with connected AC network

(b) Protection System

Central Transmission Utility of India Limited

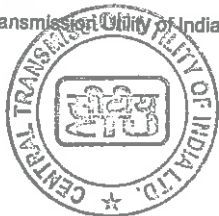

126

Khavda V-A Power Transmission Limited



181

Transmission Service Agreement

The protection system shall be designed in Main-I and Main-II set up.

(i) HVDC system protection shall consist of two parts:

(A) AC side protection

AC side protection function shall cover the zone for converter transformer, AC filters, shunt capacitors, shunt reactors, and busbars. These protections shall generally follow the same philosophy as in a typical AC substation i.e. detection of fault by relay and tripping of circuit breaker or may be dealt in similar way as described for DC side protection.

(B) DC side protection

DC side protection shall cover the zones consisting of the valve hall, DC switchyard including smoothing reactor and DC filters, DC line, and DMR line. The protection equipment shall be designed to be fail safe and shall ensure high security to avoid mal-operation/ unwanted shutdown due to protection equipment failures. 'Main-I and Main-II' or 'Main and Standby' protection philosophy shall be adopted for HVDC equipment and system.

(ii) Following a DC Line fault, the HVDC System shall have the facility to restart. The DC transmission system shall be capable of recovery in a controlled and stable manner without commutation failures during recovery following AC and DC system faults. The post fault power order shall be equal to the pre-fault power order unless AC/ DC systems dictate otherwise.

(iii) Protection system shall have two redundant systems with following protections (Some protection can be combined).

- a) Converter differential protection , Converter protection.
- b) AC, DC over current/under current protection
- c) AC, DC bus differential protection
- d) AC conductor ground fault protection
- e) Commutation failure protection
- f) DC filter protection
- g) Converter transformer valve winding protection
- h) DC line differential protection
- i) DC under voltage/ over voltage protection
- j) DC line ground fault protection with restarts
- k) Dedicated Metallic Return (DMR) protection
- l) AC filter protections
- m) Thyristor failure monitoring.
- n) Converter protection
- o) DMR line monitoring and protection

Central Transmission Utility of India Limited

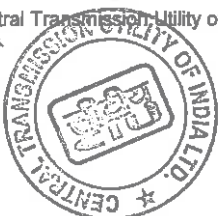

127



Khavda V-A Power Transmission Limited



182

- p) Sub Synchronous Torsional Interaction (SSTI) Protection (corresponding to synchronously run Power Plants)
 - q) Sub Synchronous Control Interaction Protection (corresponding to RE plants) etc.
- (c) A control and protection replica hardware (without redundancy) along with simulator shall be implemented for ± 800 kV, 6000 MW KPS2- Nagpur HVDC System. The software and hardware design philosophy of control and protection replica shall be based on the actual design of ± 800 kV, 6000 MW KPS2-Nagpur HVDC LCC HVDC system. However, it shall be possible to reconfigure and change parameters in the controllers. The supply shall also include simulator interface panel, station HMI, Transient Fault Recorder, Station GPS clock, network equipment, Uninterrupted Power Supply (UPS) system, communication cables, cable trays/racks and other associated accessories.
The details are mentioned in Appendix-C.6.

24. DC Line fault locator

DC online fault locators shall be provided to monitor the entire DC line length and give location of the fault with good accuracy in the range of + 1000 meters for pole conductors. DC line Fault Locators shall utilize a method of measurement of time of arrival at each end of the HVDC line of the steep wave fronts, resulting from a fault on the HVDC, affected by the accuracy of the time measurements. Since the wave fronts shall propagate along the lines at 3×10^8 m/sec (or 300 metres per microsecond), the time measurements must be in microseconds with an accuracy of ± 3 microseconds in order to achieve a location accuracy of approximately ± 1 km. Greater precision of fault location would be desirable. The DC online Fault Locator equipment at each station shall be time synchronized to the master clock system at the station in order to facilitate analysis of system disturbances recorded on the DC Line Fault Locators, the transient fault recorders and the alarm monitoring and recording system. Manually re-settable fault counter shall be provided as part of the equipment.

ELECTRIC CHARACTERISTICS

1) Control Panels

Identical control panels shall be provided for each DC Line Fault Locator within its own cubicle(s). The control panel shall include, but not be limited to the following facilities.

- Equipment on/ off control and indication;
- Equipment alarm or failure indications;
- Fault location readout display for the last detected line fault;
- Manual initiation of automatic self-test routines;

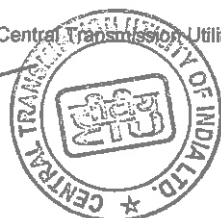

183

- Any other controls or indications

2) Printers

A printer shall be provided for each DC Line Fault Locator or it may be integrated with operator control and monitoring system. The printer shall print the day, hour, minute, second and millisecond of each fault or manual or automatic system test. The printer shall also print the location of each fault in kilometres from the respective station.

If fault locator is integrated with operator control and monitoring system that all these details shall be displayed on Video Display Unit (VDU) and stored in archives in the backup memory.

3) Power Requirements

The equipment shall be suitable for operation from the station battery supply. There shall be no loss of accuracy within specified variations of DC input voltage.

Note: Alternatively, TSP may also propose an integrated solution with the fault locator integrated into the HVDC Control and Protection system meeting the system requirements. If fault locator is integrated with operator control and monitoring system, then all these details shall be displayed on Video Display Unit (VDU) and stored in archives in the backup memory.

25. Operations supervision and control

- a) The TSP shall provide the control facilities from the operator control desk through a monitor and keyboard/mouse system. These facilities shall include all control operations, digital setting, indicating devices, Station single line diagram and symbols, any other special control devices and meters required for control and monitoring of the complete HVDC system.
- b) The layout of the station single line diagram, together with control, indicating and metering devices on the control desk shall be logical, compact, of pleasing appearance, and shall facilitate efficient supervision and operation of the station(s) by the operator. Every detected change of position shall immediately be displayed in the single-line diagram on the station screen, recorded in the event list and printable.
- c) Graphic representation of thyristor valves and valve cooling piping network shall be provided on station monitoring system. The graphical representation shall also display faulty thyristors in different colours indicating faulty thyristor position.
- d) The 'Sequence of events' recorder, transient fault recorder, on-line DC Line fault locator, GPS system, Station Master Clock, visual display system, operator control protection and monitoring system shall be a part of the HVDC system.



The details of operator control and monitoring system are provided at 'Annexure- Operator Control and Monitoring System'. The Transient Fault Recorder provided for the HVDC system shall be as per 'Appendix C.3'

26. Telecommunication

For smooth operation of the HVDC system, communication network with high reliability and availability shall be provided for transmission of control and protection signals between the two or more (in case of multi-terminal DC) HVDC terminals. The communication system design shall be as per 'Annexure- Specific Technical Requirements for communication'.

A limited remote data transfer of the HVDC system from the Load dispatch centers shall be provided by TSP. All required remote control and remote monitoring facilities shall be provided at each converter station. Complete remote monitoring of each converter station shall be possible from opposite converter station.

Synchro phasor measurement using Phasor Measurement Units (PMUs) along with fibre optic connectivity, Global Positioning System Receiver and communication equipment shall be provided for monitoring AC side of converter bays of HVDC station.

27. Valve Hall

The valve hall shall mainly contain thyristor valves, its associated structure, cooling and arresters. No oil filled equipment shall be present inside the valve hall. In case the turret of converter transformers (having oil) is protruding inside the valve hall, suitable fire barrier matching with adjacent valve hall wall fire rating shall be provided. The valve halls shall be provided with interference screening, if required by OEM. In addition, the control cable and cable termination rooms shall be suitably screened to minimize radio interference. Necessary measures shall be taken to take care of high frequency noise emission from valves.

The valve halls shall have ample clearances such that the inspection of valves can be possible and allow access of mobile valve servicing equipment without any dismantling. The valve hall building shall be pressurized to prevent the ingress of unfiltered air. In addition, the building shall be properly sealed to minimize the flow of outside air into it and vice versa. Openings for equipment and services shall be weather proof. The Valve hall building shall consist of steel framed structure. The steel building shall be pre-engineered building fabricated in the factory and shall be assembled at site. Minimum two nos. scissor lift for erection and maintenance of valve modules shall be provided per station. Proper cable sealing shall be provided for cable entry into valve hall and control room to avoid entry of water and moisture.

28. Ventilation System for Valve Hall

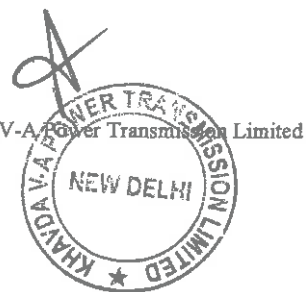

Each valve hall shall have an independent ventilation system. Each ventilation system shall consist of two 100% capacity systems, one operating and one stand-by.

The ventilation of the valve hall shall be of a positive pressure type. Once through ventilation system will not be acceptable. The ventilation system shall be a closed cycle with fresh air intake limited to a maximum of 20% of the total air requirement. Fresh outdoor air shall be filtered and dehydrated before being blown into the valve hall by the air fans to avoid dust accumulation and condensation on components present in the valve hall. Suitable measures shall be taken to minimise stagnant air. Each valve hall shall be provided with remotely operated motorized exhaust dampers which shall be normally closed and will be opened under high pressure/emergency conditions only.

To ensure that the air being supplied to the valve hall is free from dust particles, a minimum three stage dust filtration process shall be supplied. This shall consist of at least the following:

1. Pre-Filters: To remove dust particles down to 10 microns in size with at least 95% efficiency.
2. Fine Filters: To remove dust particles down to 5 microns in size with at least 99% efficiency.
3. Absolute Filters: To remove dust particles down to 0.3 microns in size with at least 99.5% efficiency.

All the filters shall be panel type. Easy access should be available to the filters for replacement/cleaning.

It shall be possible to maintain specified conditions continuously inside the valve hall, both automatically and manually controllable from the station service panel (located in the control room) as well as from the local control panel.

In addition to the alarms for particular parameters like pressure, temperature & relative humidity etc., indicating instruments shall be provided for each valve hall. These parameters shall be integrated with station monitoring system also.

The valve hall shall be kept at a pressure above the atmospheric pressure under all conditions. The test shall be conducted at site to measure the pressure inside the valve hall for 48 hours.

Adequate numbers of de-humidifiers shall be provided for each valve hall as per design requirement.

29. Air Conditioning System

Air conditioning shall be provided on a continuous basis in the control room, bay kiosks, valve module workshop & storage rooms, control & protection workshops, offices, first aid room, conference room, entrance halls, corridors etc. and all rooms containing electronic equipment.

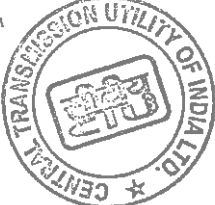

186

The air conditioning system for the control room shall consist of two (2) systems each of 100% capacity; one operating and one stand-by. Both units shall be interconnected so that, in the event of breakdown of one unit, the stand-by unit can be placed into service. Stand-by and operating units shall be alternated monthly for regular operation. The operation of the units shall be automatically controlled including sequential start and stop with single command.

If valve base electronics and/or valve cooling control cubicles are located at places other than in the station control room, these areas can be cooled by using split Air Conditioning units of appropriate capacity. At least two units shall be provided, one operating and one stand-by with the facility of automatic changeover after operator assigned time period.

A separate air conditioning system shall be provided for other areas of the service building. This shall also consist of two (2) Nos. each of 100% capacity; one operating and one stand-by.

30. Visual monitoring system (VMS) for watch and ward of station premises:

Visual monitoring system for effective watch and ward of substation premises shall cover all the transformers and reactors, outdoor DC yard, valve halls, indoor and outdoor isolators, earth switches, breakers, AC and DC capacitors, all other major AC Equipment (such as CB, isolators, CT, CVT, SA etc. as applicable), panel room, all entrance doors for the service building, other buildings, all the gates of switchyard and all entry and exit points of control room building and accordingly the location of cameras shall be decided. In addition to these locations, the cameras shall also be located around the boundaries at suitable locations. The camera shall be high definition color CCD camera with night vision feature. The VMS data partly/completely shall be recorded (minimum for 30 days) at least @25fps (or better) and stored on network video recorder and followed by transfer of the data to a juke box. The system shall use video signals from various cameras installed at different locations, process them for viewing on workstations/monitors in the control room and simultaneously record all the cameras. The VMS data should go only to the intended personnel/facility and not to the remote server of the Camera (VMS supplier). The operation of cameras shall be integrated with the Network server placed in Control room of HVDC station. Sensors shall also be placed on boundary walls to prevent intrusion from outside and shall be connected to the CCTV system.

Mouse/keyboard controllers shall be used for pan, tilt, zoom and other functions of the desired camera. The Visual Monitoring System shall have provision of WAN connectivity for remote monitoring.

All camera recordings shall have Camera ID & location/area of recording as well as date/time stamp. The equipment should generally conform to Electromagnetic compatibility requirement for outdoor equipment in EHV substation.

At existing HVAC substations, the visual monitoring system if available shall be augmented as per existing or better specification as required.

Central Transmission Utility of India Limited

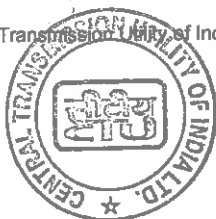

132

Khavda V-A Power Transmission Limited

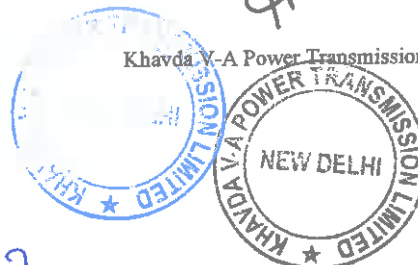

187

31. Building Management System

A fully computerized and automatic Building Management System (BMS) shall control the operation of the mechanical systems serving the valve hall and service building and other systems as detailed below.

Scope of Work

The scope of work shall cover all necessary system provisions (including hardware and software) for synchronizing/integrating the BMS with the control and monitoring of

- Air Conditioning system,
- Valve hall ventilation system
- Fire Fighting Systems including Fire Spray and Hydrant systems, water level in Fire Water Tanks etc.
- Utility Services i.e. Water Storage and Supply,
- Access Control including Motorised Gate at the entrance to the station and for all entrance doors for the control room building including provision of electromagnetic door locks, card readers etc.
- Fire Detection and Alarm System.
- Illumination systems
- VMS

32. Water Supply and Distribution System

The water supply and distribution system shall include the supply, distribution and storage of water in the HVDC Station at least the following purposes.

- a) storage of water for the firefighting system;
- b) storage of water sufficient for 24 hours of continuous operation of HVDC converter in the event of interruption of water supply to the tanks;
- c) water supply for the valve cooling system;
- d) water supply for sanitary services;

Two nos. 100% capacity water storage RCC tanks shall be provided. Each tank shall be constructed in such a way that there shall be segregation between requirement for fire water storage and water for other purposes. Both the tanks shall have interconnection piping with isolation valves for both tanks. Separate piping as per IS/IEC standard for firefighting, valve cooling and other purposes shall be provided from the tanks from independent headers.

33. Grounding & Safety:

Central Transmission Utility of India Limited

133

Khavda V-A Power Transmission Limited



188

- a) The design of the grounding system shall be based on relevant IS/IEC/IEEE standards.
- b) In order to prevent adverse effect (i.e. overheating due to induced circulating current) of magnetic field of air core reactors; special care shall be taken e.g. no closed loops are formed by the earthing conductors and in reinforcement bars of the foundation or other necessary mitigation measure to be provided. Air core reactor manufacturer's guidelines shall be followed.
- c) The electrical safety clearances for the DC side shall not be less than the clearances applicable for an AC switchyard at the equivalent BIL level.
- d) The total electric field at ground level shall be as prescribed in relevant standards.
- e) Fencing and electrical interlocking & mechanical key arrangements shall be provided for all non-accessible areas, for valve halls, and for areas where for equipment mounted directly on ground without suitable height of steel structure, e.g. smoothing reactor area, AC and DC filter areas, as applicable.
- f) Safety precautions in regards to gas/oil pipe lines in vicinity of HVDC/ AC lines shall be taken coordination with gas/ petroleum authorities.

Central Transmission Utility of India Limited



134

Khavda V-A Power Transmission Limited



189

34. Cables:

All cables shall be FRLSH type. The High Voltage (6.6 kV to 33 kV) power cables shall be XLPE insulated conforming to IS-7098 Part-2. The Low Voltage power cables shall be 1.1 kV XLPE insulated conforming to IS-7098 Part 1 or relevant IEC standards and/or PVC insulated conforming to IS-1554 Part 1. The control cables shall be 1.1 kV PVC insulated conforming to IS-1554 Part-1. The rating and size of cables shall be determined by TSP. All cables shall be armored except cables used for special purpose as per OEM recommendation. Fibre optic cables conforming to IEC- 60793 and 60794 shall be used to transmit the signals to and from various equipment and panels located in the AC/DC switchyards, Valve Halls, control rooms, valve cooling rooms etc.

35. Auxiliary Power Supply System:

The auxiliary power supply system shall have the following:

- a) Highly reliable duplicated supply sources from two separate sources with automatic change-over facilities. Each of the sources of auxiliary power shall be from 33 kV side of 2 Nos. of 765/400/33 kV transformers (1500 MVA) at KPS2 and 33 kV tertiary of 2 nos. 765/400/33 kV ICT at Nagpur. This source shall be stepped down to 433 V by means of station service transformer of minimum 2000 kVA capacity and rated 33/0.433 kV.
- b) Completely separated secondary distribution (415 V) systems for the auxiliaries of each converter.
- c) Duplicated supply by two different 415 V power sources to essential loads
- d) Diesel Generator (DG) Set of minimum 1500 kVA capacity per pole shall be provided to meet essential loads. This generator set shall start automatically and cater load immediately in case of loss of all the normal and standby supply sources. The DG sets shall be designed and rated so as to meet the load time characteristics of the essential loads of the entire station as determined by the TSP with a 10% margin on the load.
- e) Parallel operation between station service transformers shall not be permitted at any voltage level in order to limit fault currents, prevent back feed into the AC bus and to ensure independence of supply sources. Also, parallel operation shall not be permitted between transformers and the DG set.
- f) Suitable protection on all primary MV and LV supply connections shall be provided.
- g) The 220 V DC supply system(s) per pole shall consist of at least two independent DC systems; each system consisting of one float-cum-boost charger, one battery bank and one distribution panel. A 48 V DC system consisting of two battery sets, two battery chargers and two distribution boards shall also be supplied for communication panels (wherever supplied). If desired, 48 V supply may be obtained from 220 V DC battery



bank by use of adapters, without compromising backup time.

- (i) The station services DC system shall cater to the DC loads of HVAC and HVDC switchyards, auxiliary services control, valve and pole control, protection circuits, communication system loads etc.
 - (ii) Minimum lighting load shall be connected to the station DC system.
 - (iii) Sizing of 220 V battery and battery charger shall be done based on the number of bays specified (including future bays) as per CEA Regulations and relevant IS. 2 sets of 48 V battery banks for PLCC and communication equipment for present and future scope shall be provided at each new Substation with at least 10-hour battery backup and extended backup, if required.
- h) All auxiliaries shall give rated output at voltage variation of $\pm 10\%$ and frequency variation of -5% to $+3\%$. Sizing of LT Switchgear shall be suitable to cater the requirement for all present and future bays. AC & DC distribution boards shall have modules for all the feeders (including future as specified).
- i) For substation extensions, existing facilities shall be augmented as required.

An indicative SLD for the Auxiliary Supply System is enclosed at 'Appendix-C.5'.

For the requirement of the Auxiliary Power as described above, Essential Load is defined as per below: -

Essential loads: *These are the loads whose failure shall affect the conversion capability of the HVDC system. These loads shall include, but not be limited to, the cooling and other auxiliaries of the converters, the cooling of transformers and reactors, valve hall cooling, etc. In addition, loads that must remain working in case of complete loss of the AC power supply shall also be included in essential loads. These loads shall include, but not be limited to, the station battery chargers, disconnecting switching and circuit breakers operating mechanism, the emergency lighting, fans to keep over pressure in valve halls, etc.*

36. Fire Detection, Alarm and Protection system:

A comprehensive fire detection, alarm and protection system as per Central Electricity Authority (Measures Relating to Safety and Electric Supply) Regulations, 2023 shall be provided. Valve Hall shall have Air aspiration system (fast and early smoke detection system). Suitable Infra-Red (IR)/Ultra Violet (UV) detector to detect the flashover inside the Valve Hall shall also be provided. The Valve hall wall towards converter transformers shall be suitable for minimum 3-hour fire rating.

Suitable fire detection system using smoke detectors and/or heat detectors shall be provided in HVDC Station for all room and areas. These smoke fire detection systems shall be connected to a separate Fire annunciation system clearly identifying the zone.

Central Transmission Utility of India Limited



136



Khavda VVA Power Transmission Limited



191

Hydrant System:

Suitable No. of hydrants shall be provided for protection of HVDC Station equipment in the yard and HVDC Station building.

HVWS System:

High Velocity Water Spray (HVWS) system shall be provided for converter transformer, ICTs and Shunt Reactors.

37. Testing and trial operation

All equipment/components including Thyristor valves, Converter Transformers, smoothing reactors, EHV DC Transformer bushings and wall bushings shall be subjected to Type tests, Routine tests, Factory Acceptance Test (FAT), Site Acceptance Test (SAT) as per relevant IS / IEC/ IEEE as applicable. The SAT shall consist of sub-system & system tests and shall be carried out after installation of equipment at site. The sub-system tests cover the major sub-system like valve cooling, AC & DC filters, HVDC converter, auxiliary systems, communication etc. After completion of sub-system tests, system tests covering power transmission tests, transient & dynamic control tests, measurement of electric field and RFI etc shall be conducted. After completion of all system tests, final trial operation of the HVDC System shall be carried out for continuous period of normal operation of not less than 10 days (for each Pole/Bipole separately, followed by entire HVDC link consisting of two parallel Bipoles again for 10 days) during which the converter equipment shall be fully operational. The HVDC System shall be declared under Commercial Operation after the successful completion of its Trial Operation.

38. Reactive power exchange

The reactive power exchange limits with the system for the Converter Stations are specified in this specification.

The following reactive power exchange limits shall be honored by the HVDC system:

(A) Reactive power exchange limits

Table 9

Minimum DC Power 150 MW	Maximum DC Power 3000 MW per bipole
In the entire range of HVDC power	
400 kV AC SYSTEM KPS2 bus sections	
Maximum Export at 420kV 50 MVAR	Import NIL at 380kV
400 kV AC SYSTEM Nagpur	
Minimum DC Power 150 MW	Maximum DC Power of 6000MW



	(3000 MW per bipole)
In the entire range of HVDC power	
Maximum Export at 420kV 100 MVAR	Import NIL at 380kV

The 400kV Bus sectionaliser at KPS2 is planned to be normally open and 400kV Bus sectionaliser at Nagpur is planned to be normally closed. However, the design should also consider the possibility of 400kV Bus sectionaliser at either end to be kept open/closed based on system conditions.

The control of reactive power exchange shall be fully automatic and shall be continuously monitored. The control equipment, however, shall allow both automatic and operator-initiated switching. In the former case, adequate annunciation shall be provided to the operator. The reactive power control system shall not require any element switching for DC power flow changes of 150 MW in either direction since the last switching operation had taken place. Switching necessary to maintain the AC bus voltage within the ranges specified is permissible for power order changes of less than 150 MW.

Each breaker used for switching shunt reactive elements shall have point-on-wave switching control for energizing its branch, to minimize voltage disturbances while switching capacitors and filters, and minimize DC offset current while switching shunt reactors. Breakers used for switching shunt reactive and filter elements must be capable of de-energizing their branch at the maximum temporary overvoltage conditions specified in this specification, or as determined by the TSP's studies, including full load rejection studies, whichever is greater. The reactive compensation and overvoltage limiting equipment shall be designed such that at any power transfer level up to rated power in either direction, a complete or partial interruption of DC power transfer shall not result in a fundamental frequency over voltage beyond the values specified in this specification. The TSP shall provide controlled or point-on-wave switching for synchronous closing of converter transformer.

All the necessary studies of reactive compensation and voltage control shall be performed. The calculations of reactive power exchange and of voltage control shall be based on the most unfavorable combination of tolerances on equipment, connected system configuration and of changes in operating conditions.

39. Pole Blocking

The HVDC System shall be designed such that the power transfer loss of a faulted Pole due to Pole blocking or during DC line fault clearing is transferred to the remaining Pole. The power transfer on the remaining Pole shall be increased up to its rated short-time power transfer capability to compensate for the power transfer loss on the faulted Pole and to minimize AC network disturbance.

Central Transmission Utility of India Limited

Khavda V-A Power Transmission Limited

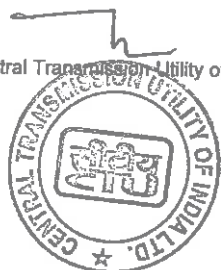

193

When an increase in power transfer of the healthy Pole is required due to blocking of the other Pole, 90% of the increase in DC power transfer required shall be achieved within 100 milliseconds of the faulted Pole blocking.

For the case where a Pole blocks while communications are not in-service, 90% of the required DC power transfer to the other Pole shall be achieved within 100 milliseconds of the rectifier blocking.

The HVDC System shall recover to 90% of the pre-fault DC power transfer level consistently within 120 milliseconds from the instant of fault clearing, without subsequent commutation failure on the faulted or healthy Pole or sustained oscillation for all inverter system fault conditions. For all rectifier AC system fault conditions, the recovery time, to 90% pre-fault power level, shall be within 100 milliseconds from the instant of fault clearing. This recovery time shall be achieved for all short circuit levels as defined in this specification.

If it is in the interest of the overall improved recovery of the AC/ DC system, in such cases the recovery times other than those specified shall also be acceptable, subject to review

40. Pole Deblocking and Converter Start-up

A coordinated sequence of starting an HVDC Pole shall be established and demonstrated during FAT. The sequence shall be in a such a manner that it will not impact the connected AC system. It shall be possible to start and deblock at minimum DC power specified in this specification earlier while maintaining all the AC and DC filter performance requirements.

41. AC bus fault

The TSP shall demonstrate the response of the power controller to DC voltage changes in the rectifiers and inverter for solid converter AC bus faults, both single phase-to-ground and three phase-to-ground.

The HVDC system shall recover to 90% of the pre-fault DC power transfer level consistently within 120 ms from the instant of fault clearing, without subsequent commutation failure or sustained oscillation for all inverter AC system fault conditions. For all rectifiers AC system fault conditions, the recovery time, to 90% pre-fault power level, shall be within 100 ms from the instant of fault clearing. This recovery time shall be achieved for the fault levels above the minimum specified in Table-1. Recovery times greater than specified above shall be acceptable only if the higher recovery times results in the overall AC and DC system improvement.

The response time shall be determined in accordance with the general criteria defined in this specification. The specified response for the rectifiers ac system and inverter ac system faults shall be demonstrated [400 kV & 765kV level at KPS2 (HVDC), 400 kV and 765 kV level at KPS1, 400 kV and 765 kV level at KPS3, 765 kV level at Lakadia, 765 kV level at Halvad, , 400 kV and 765 kV level at Nagpur (HVDC), 765 kV level at Raipur and 765 kV



194

level at Wardha] for the following conditions:

- (i) Single phase-to-ground faults, for five cycle, ten cycle, and twenty cycle fault clearing and with fault levels resulting in voltage reduction to 90%, 70%, 50%, 30%, 20%, and 5% of nominal converter AC bus voltage.
- (ii) Three Phase-to-ground faults, for five cycle fault clearing, with fault levels resulting in voltage reduction to 90%, 70%, 50%, 30%, 20% and 0% of nominal converter AC bus voltage.
- (iii) Zero impedance three phase 400 kV AC busbar faults at KPS2 and Nagpur which are cleared after five cycles and which result in the loss of one DC pole.
- (iv) Three phases to ground, five cycle, and Single line to ground, ten cycle faults. The outage of components would include 400 kV single circuits, 400 kV double circuits if these are on same tower, generator, filter bank etc.
- (v) Three phase to ground, five cycle, and Single line to ground, ten cycle faults following conditions when system is already running under single contingency and which result in outage of further system components. The outage of components would include 400 kV single circuits, 400 kV double circuits if these are on same tower, generator, filter bank etc. Under such conditions it shall be shown that the system stability is maintained although the time required for recovery may exceed the values given above. For certain cases if there is a need for run back condition on HVDC the same shall be evolved by the TSP.

42. DC Line Faults

The DC line fault protection sequence shall detect the fault, de-energize the faulted line Pole by control action, allow a time period for fault deionization (settable between 50 ms to 1000 ms), and then automatically attempt restoration of the DC power transfer on the Pole.

There shall be 2 full voltage restarts followed by 1 reduced voltage (80% DC voltage) restart attempt. All equipment shall be dimensioned keeping these 3 restart attempts in mind.

For mono-polar Metallic return, minimum one restart attempts shall be considered at full voltage and current corresponding to 10% overload operation.

The minimum total time to restore the DC power to 90% of the pre-fault DC power from the end of the deionization period shall not exceed 100 milliseconds (excluding the time allowed for deionization).

The system shall be designed and capable of the following:

- a) During the DC line fault and deionization interval the power transfer on the non-faulted Pole shall be rapidly increased to the extent possible in order to minimize the impact on the DC power transfer.
- b) On recovery of the faulted Pole the power transfer on both Poles shall resume the pre-

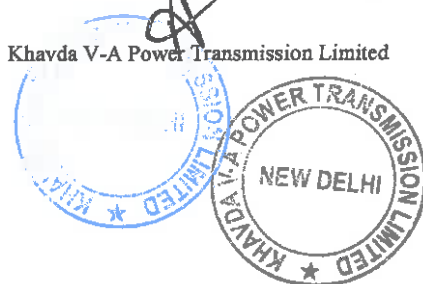

fault values.

- c) The transfer of power to the non-faulted Pole during the line fault clearing and recovery sequence shall occur even when the HVDC telecommunications are not in service.
- d) The healthy Pole shall not fail commutation when a DC line faults occur on the other Pole or any time there after until the faulty Pole is back to normal operation.

The clearing and recovery of a DC line Pole fault shall be demonstrated in bipolar and monopolar mode at 1.0 pu power transfer prior to the fault for the particular mode. Faults shall be applied at the line ends and at the line midpoint in both power directions. The demonstration shall include the influence of the function provided to transfer power from the faulted Pole to the other Pole.

Suitable modeling of the DC line, which takes into account the electro-magnetic coupling between the Poles, shall be considered in the above studies.

DC reduced voltage restart shall be possible even when there is no telecommunication between rectifier and inverter stations.

43. Operation During Reduced AC Voltage Conditions

To assist in the recovery of the network, the Converter Stations shall be able to continue operation with reduced AC bus bar voltages.

In addition to the requirements of operation under over voltage conditions specified in this specification, the converter equipment shall be able to continue operating without blocking of converters with AC bus voltage reduced to voltage as depicted in the curve mentioned under LVRT Strategy at clause No.-14 "Insulation Coordination" during three phase faults, and to zero on one phase during single line to ground faults followed by voltage recovery to 80%. The gate control units shall be able to trigger the thyristor valve as soon as the voltage recovers after the AC bus voltage has dropped. The converters shall continue to transmit power to the extent possible under the above reduced voltage conditions. The valve firing system as well as all the cooling equipment shall be rated for these conditions. The cooling system shall not trip during AC system faults..

44. Controlled Shutdown

Each Pole shall be able to be shut down in a controlled manner by the automatic reduction in the power order accompanied by appropriate AC harmonic filter bank switching. The block and isolation of a converter Pole shall be done without the block or shutdown of other Pole converters.

45. Power Runback

The controls shall be capable of achieving 90% of any step change requested by run-back modulation signals including within 200 milliseconds of receipt of the run-back signal.

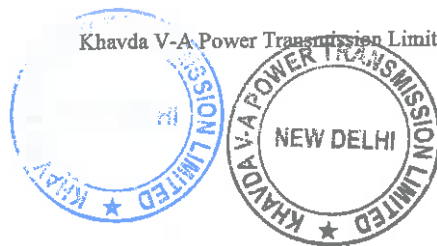

46. Commutation Failure Performance

There shall be no commutation failures for the disturbances described below:

- a) Disturbances resulting in AC voltage drops of 15% or less compared to the voltage prior to the disturbance. In this case, repetitive commutation failure shall not occur (though one or two commutation failure may occur).
- b) Dynamic AC voltage swings of less than $\pm 10\%$ with an oscillation period of one second or longer.
- c) Switching of any reactive element in the Converter Stations.
- d) Energization of the converter transformer on the other Pole or any other AC transformer in the switchyard.
- e) Sympathetic commutation failures shall not occur on the healthy Pole for faults on the other Pole.
- f) The control system shall be designed to prevent multiple commutation failures after one commutation failure is detected.
- g) The switching in and out or a tripping due to faults of a filter sub bank at the converter stations shall not result in a commutation failure, except for faults at 400 kV side of the filter sub bank.

47. Cyber security

The designed system shall be compliant with:

- a) IEC-27001 Information security management
- b) IEC-62443
- c) CEA (Cyber Security in Power Sector) Guidelines, 2021

Cyber security shall be incorporated in the overall design of the HVDC controls, protection, communications, HMI and SCADA systems. The TSP shall propose a secure and robust design in the control and LAN systems, using next generation firewalls, dual firewall communication designs, routers, gateways, data diodes, etc. that have built in cyber secure measures.

48. Performance Guarantee for Converter Station (excluding HVDC line)

- a) HVDC Station losses: The Guaranteed losses of HVDC converter stations shall include the no load loss and equivalent load loss. The equivalent load loss is the sum of load losses at specific loadings multiplied by weightage factors as per expected loading cycle. The Guaranteed losses shall be verified as per IEC 61803. The above losses shall be guaranteed



Central Transmission Utility of India Limited

197



Khavda V-A Power Transmission Limited



Transmission Service Agreement

- at nominal DC voltage (± 800 kV at rectifier end) and nominal AC system Voltage (400 kV, 50 Hz) at ambient temperature of 40 deg C and relative humidity of 50%.
- b) No load loss shall be guaranteed corresponding to converter transformer set at principal tap## with nominal AC system voltage and nominal frequency. Also refer maximum guaranteed loss figures in table below:
 - c) The system shall meet various harmonic performance parameters on both AC side and DC side as well as the reactive power exchange limits on AC side as per these specifications while calculating the guaranteed losses.
 - d) Design targets for HVDC station Reliability and Availability^{^^} and station guaranteed losses[^]:

Table 10

1	Overall Energy availability of HVDC scheme per Bipole of 3000 MW (a) Overall Performance (b) Excluding transformer	Not less than 97% Not less than 98%
2	Forced Energy Unavailability (FEU) per Bipole of 3000 MW	Not more than 0.6%
3	Schedule Energy Unavailability (SEU) per Bipole of 3000 MW	Not more than 1%
4	Single Pole outage per station per year	Not more than 8 (with average outage duration of 7.5 hours)
5	Bipole outage per station per year	Not more than 0.2 (with average outage duration of 8 hours)
6	No-load losses operation losses per Station	0.1 % of Bipole Rating
7	Equivalent load loss per station (kW)*	0.35% of Bipole Rating

* **Equivalent load loss**= Load loss at 1000 MW in kW*0.4 + Load loss at 1500 MW in kW * 0.16 + Load loss at 2500 MW in kW * 0.16 + Load loss at 3000 MW in kW * 0.28).

[^] - These loss figures shall be calculated on per station and per bipole basis as per details mentioned in (a), (b), (c) and (d) of this clause.

^{^^}The details for calculating Availability are mentioned in 'Appendix C.4'.

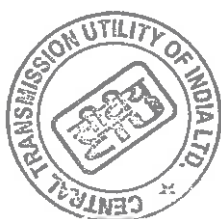

'Appendix C.4'. ## Principal tap is the Tap Position of converter transformers when HVDC converters shall be delivering 1 p.u. power (6000 MW) at nominal DC voltage at rectifier (± 800 kV) keeping AC system voltage 400 kV, 50 Hz at 40 deg C ambient temperature and humidity of 50%.

For the loss guarantee stated above, following equipment/systems shall be considered:

e) Determination of losses

The total losses of the HVDC converter station shall be calculated as the sum of the losses determined for each individual equipment. The major components to be included in the loss calculation and guarantees and the method of assessment for each component shall be as follows:

1. Converter Transformers as per IEC 60076-57-129
2. DC Smoothing Reactors
3. Thyristor Valves as per IEC 61803
4. Reactive Power Equipment, AC FILTER
5. Auxiliary Power Transformers
6. DC Filters and 50 Hz blocking filter as per IEC 61803
7. Miscellaneous Losses for the following equipment shall also be included:
 - a) Devices used for TOV suppression
 - b) Direct current voltage transformer
 - c) Surge capacitors
 - d) RI & PLC filters

Specific Exclusion:

Equipment specifically excluded from the loss calculations shall be the oil treatment plant and firefighting load, station auxiliary system energy consumption (such as illumination of indoor and outdoor services, Air conditioning & ventilation system for control room, service building, kiosk, battery & battery charger etc.) except auxiliary power consumption required by Converter transformer cooling and Valve cooling system.

f) Guaranteed Failure Rate of Thyristors

The maximum annual guaranteed thyristor level failure rate shall not exceed 0.2% per 12 pulse valve group. The failure rate shall not include failures directly attributable to operating and maintenance errors.

g) AC/DC HV Filter Capacitor Failure Rate Guarantee

The maximum guaranteed annual capacitor failure rate shall not exceed 0.15% except first unit failure. The capacitor shall be considered as failed if its Capacitance value varies more

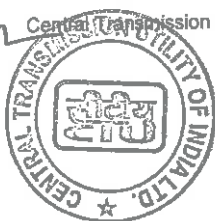

than $\pm 5\%$ of the (actual measured) name plate value or as indicated by manufacturer. Leakage of oil from the capacitor and deformation of the capacitor unit shall be considered as a failure even if the capacitance value is within the tolerance limits.

h) Flashover Guarantee

Flashover is defined as breakdown of insulation for self-restoring insulation media which leads to outage as defined elsewhere in this specification. TSP shall guarantee that there shall be not more than two pollution related flashovers per station per year for DC yards (base environmental conditions as given in this specification will be considered) for each Bipole separately. In case of a flashover, TSP shall make necessary investigations to establish the cause of the same, propose mitigation measures and implement the same. In case of flashover in common neutral area of both Bipoles, the flashover shall be counted in one of the Bipole with lesser number of flashover.

i) Guaranteed Failure Rate of Relay Module/ C&P Module/Component

The guaranteed failure rate of relay module/ C&P module/ component shall not be more than 0.5% (except 1st unit failure). This will include individual circuit boards but not computers. The failures directly attributable to operation & maintenance errors and other incidents unrelated to the DC system shall not be included in the calculation. The relay module/ C&P module/ component failure rate shall be monitored on per pole per station basis.

49. Commissioning and start of operation

The purpose of commissioning period is to demonstrate to the Nodal Agency satisfaction that the equipment is ready for its purpose and it functions satisfactorily under normal operating conditions. The testing and commissioning period will have the necessary duration to demonstrate the proper functioning of all the Project equipment and systems.

a) Site Testing

After the installation and preliminary adjustments of equipment, the Site tests shall be performed in the following stages:

- Erection checks
- Commissioning tests
- Sub-system tests
- Sub-system energization tests
- System tests

The site testing has been categorized in above stages for the sake of convenience only. There may be overlapping of two or more stages for particular tests. The TSP shall perform the site testing with complete responsibility.

Central Transmission Utility of India Limited

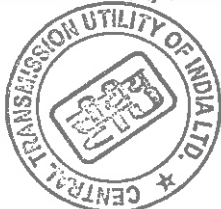

145

Khayda V-A Power Transmission Limited

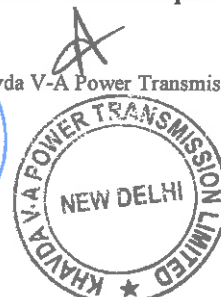

200

The TSP shall provide all instruments, equipment and facilities required to perform these site tests. Calibration certificates for the test equipment shall be made available at site prior to the start of the testing.

All special and test equipment necessary to simulate devices or switching sequences and required for commissioning shall be provided by the TSP. Results of the site tests shall be well documented and shall form a part of plant documentation.

50. Mandatory Spares:

The mandatory spares for the HVDC Station shall be as per 'Annexure-B, 4. Mandatory spares for HVDC stations (substation/switchyard level)' of CEA's 'Guidelines for availability of spares and inventories for power transmission system, transmission lines & substation/switchyard) assets, 2020'.

The specific exclusion to the above list is Sl. No. 2.1, Converter Transformer and Sl. No. 3, Smoothing Reactor. Other Converter Transformer spares from Sl.No. 2.2. to Sl. No. 2.41 to be provided. The spare requirement for Smoothing Reactors shall be as per Clause 22 d).

Minimum one No. (single phase two winding) spare Converter transformers of each type and rating per station, shall be provided. The spare Converter Transformers shall be inclusive of all fitments, hardware, bushings, as well coolers if mounted on the tank, accessories and oil complete in all respect.

51. HVDC building:

The Building shall comprise of but not limited to the following facilities:

1. Control & Relay Panel room
2. ACDB & DCDB room
3. Battery room
4. Service Room cum workshop
5. Valve hall
6. Cooling system room
7. AHU Room
8. Valve Hall Ventilation Room
9. Any Other room/facilities as per functional requirement

52. For Type Test requirement of equipment, CEA's 'Guidelines for the Type Tests for major equipment of Power Sector' is to be followed.

53. Applicable Standards:

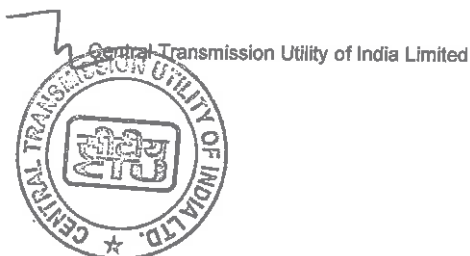

146



Khavda VVA Power Transmission Limited

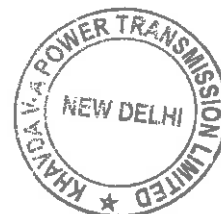

201

All equipment and material shall be designed, manufactured, tested and commissioned in accordance with latest Indian Standards / IEC or IEEE standards, / CIGRE guidelines and the Acts, Rules, Laws and Regulations of India. Some of them are as follows:

Table 11

Sr. No.	Description	Standard
1.	Terminology for HVDC transmission	IEC 60633
2.	Thyristor valves for HVDC transmission	IEC 60700(1-2)
3.	Performance of HVDC with line commutated converters	IEC 60919(1-3)
4.	Determination of power losses in High-Voltage Direct Current (HVDC) converter stations with line-commutated converters	IEC 61803
5.	High-Voltage Direct Current (HVDC) installations - System tests	IEC 61975
6.	High-Voltage Direct Current (HVDC) systems - Guidance to the specification and design evaluation of reactive power exchanges	IEC 62001 (1-4)
7.	Bushings for DC Applications	IEC 65700
8.	Insulation Coordination	IEC 60071 (1- 5)
9.	Application guide for metal oxide arresters without gaps for HVDC converter stations	CIGRE report 33/14-05
10.	Converter transformers	IEC 60076-57-129
11.	Power transformers - Part 6: Reactors	IEC 600076-6
12.	Shunt capacitors for AC power systems having a rated voltage above 1000 V	IEC 60871-(1-4)
13.	Semiconductor devices - Part 6: Discrete devices - Thyristors	IEC 60747-6
14.	Fire aspects of HVDC thyristor valves and valve halls.	CIGRE-TB 136 1999 SC 14 TF 14.01.04
15.	Guidelines for the system design of HVDC project	IEC/TR 63127 Ed. 1.0
16.	High voltage direct current (HVDC) power transmission - System requirements for DC-side equipment - Part 1: Line-Commutated Converters	IEC/TS 63014 Ed. 1.0
17.	Guidelines for operation and maintenance of HVDC converter station	IEC/TR 63065 Ed. 1.0
18.	Guidelines on Asset Management for HVDC Installations	IEC/TR 62978 Ed. 1.0
19.	Transformer for HVDC applications	IEC:60076-57-129
20.	Surge Arresters – Metal Oxide Surge Arresters without gaps for HVDC converter stations	IEC60099-9-Part -9
21.	CT's and VT's	IEC 61869
22.	Disconnectors and Earthing Switches	IEC 62271
23.	Cyber Security	IEC 62443

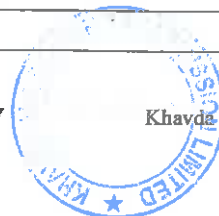
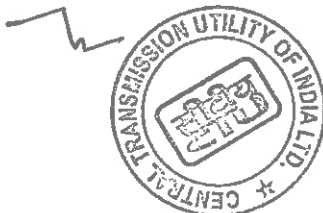

Transmission Service Agreement

Sr. No.	Description	Standard
		IEC 27001
24.	UPS, SMPS and Other Power supply units	IEC 62040 IEC 61558
25.	Other items as per relevant and prevailing standards specified elsewhere in the specification for substation works.	

Central Transmission Utility of India Limited



148

Khavda V-A Power Transmission Limited



DC Voltage Measuring Equipment

A proven type of voltage divider shall be provided for DC voltage measurement. The accuracy of the device shall not vary more than 0.5% with an ambient temperature change of 50° C. The overall voltage measuring system shall have an accuracy of at least 1.0% of full scale. The response time shall not be longer than 150 micro seconds, accepting an overshoot of up to 20% at that rise time. The measuring system shall achieve proper operation of the control and protection system to which it is connected.

The measurement range shall be sufficient to measure voltages up to 1.5 pu. Preference shall be given to devices which provide isolation between the HV primary connection and the output signal. If the output signal is not completely isolated from the HV connection, protection shall be provided to limit the possible output signal voltages to less than 2 kV in the event of a fault on the device.

All low-level signals shall be cabled separately from high level signals. The divider shall be so arranged that no leakage current on the surface of the insulator can pass to the measuring circuit. The insulator shall for this reason be continuous without any metallic intermediate flanges. Furthermore, the interior of the divider shall be so arranged that interior leakage currents do not influence the measurement.

For voltage measuring equipment to be erected in the outdoor switchyard, it shall be ensured that discharge activity on the housing shall not cause interference with the output signal.

For each voltage measuring device furnished, all necessary auxiliary power plus any equipment necessary for the transformation of the auxiliary power to an acceptable form shall be provided. Such transformation equipment shall be mounted in the control cubicles.

Direct Current Measuring Equipment

Direct Current Transducers supplied shall be mounted in bushings, if available. In locations where bushings are not available, free-standing transducers shall be provided. For each transducer furnished, the all-necessary auxiliary power plus any equipment necessary for the transformation of the auxiliary power to an acceptable form shall be provided.

The design of the measuring system shall be based on maximum interchangeability where any electronic module shall be compatible with any of the core and coil assemblies.

The transducer output signal shall be of sufficient magnitude to ensure that the content of the signal is usable at all levels of primary current from 1% to 300% of the rated current, with a measurement output possible up to 600% before saturation of the output signal occurs.

In the event of high current (up to 0.2s short circuit current), the DC CT shall remain unsaturated for 20 ms or longer. This time shall be measured from the instant the current



attains 10 pu. The DC CT shall be provided with interlock circuits that indicate saturation of the DC CT, as well as DC CT faults.

It shall be ensured that any low-level signals generated are kept shielded from interference due to other higher voltage circuits. The low-level signals shall be cabled separately from high level signals.

It shall be ensured that all DC current measurement outputs are accurately calibrated with all the respective loads connected. If required, on-site adjustments to output calibration shall be possible. The sensitivity of the devices supplied for such calibration shall be appropriate for setting the required accuracy.

The electronic module shall be provided with interlock circuits to indicate that the measuring system is fully operable.

In case of Optical DC measuring system, the materials used in it shall be non-corrosive in nature.

Stationary Accuracy

The composite accuracy of all DC current measurement systems used for protective purposes shall be equal to or better than $\pm 2\%$ of rated DC current up to 120% of the maximum rated current and $\pm 10\%$ of rated DC current up to 1.2 times peak calculated fault DC current.

All DC current measuring system used for control purposes shall have a composite accuracy of $\pm 0.75\%$ of rated DC current from minimum rated current to 120% of the maximum rated current and $\pm 10\%$ of rated DC current from 120% up to 300% of the rated current.

All transducers used for corresponding functions, e.g. pole differential protection etc shall have matching accuracies equal to or better than $\pm 2\%$ of rated current up to 300% of the rated current.

Dynamic Accuracy

The response of the measuring systems shall be such that a linear current change within 150% of maximum rated current and with a rise time of 45 ms, is tracked by the transducer output with an error which does not exceed +0%, -2% of rated current on any point of the curve. The rise time is defined as the time required for the current to change from 10 to 90% of the full current change. The frequency response shall be within +3% at 1500 Hz.

Central Transmission Utility of India Limited



150



205

Operator's Control, Monitoring and Support Systems**A. General Requirements**

All hardware such as computers, computer peripherals/printers/ accessories, testing equipment etc and networking products shall conform to latest products based on industry standard. It shall be possible to fully monitor and control both stations as described below-

- Operation control of both converter station (from monitors) from Nagpur
- Operation control of both converter stations (from monitors) from KPS2
- In separate operation control mode, all the terminals shall be able to control their own station individually.

The above selection modes shall be separately provided for control of the DC system and the AC systems of either station.

A Station operator desk to be supplied at each converter station shall be able to control the stations. The control shall be possible from TFT Monitors and operator key board/ mouse. In the event of failure of the system, control and monitoring shall be by means of direct control at the Bipole control panels, circuit breaker controls panels etc generally as shown in 'Figure-A'. This control could be made from PC connected to these control panels and necessary interface shall be provided to achieve this. The control functions to be provided from the equipment control panels shall include at least those listed under 'Table-A' and 'Table -B'. It shall also be possible for operator to know individual alarms by selecting the particular panel on the display monitor.

The TSP shall provide the equipment necessary for the purpose of control, status indication and metering of all equipment (keeping in view the intermediate Bay Kiosks to be provided in AC & DC yard,) at Nagpur and KPS2.

The control room shall generally house the following equipment:

- Operator control, monitoring and support system
- DC line fault location equipment, if not integrated within C&P system.
- Transient fault recorders, if not integrated within C&P system.
- Master controller equipment, if not integrated within C&P system.
- Station fire alarm, control & monitoring panel

Central Transmission Utility Co. India Limited

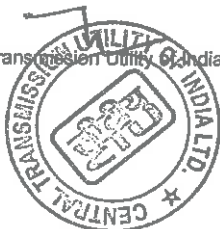

151

Khavda V-A Power Transmission Limited



206

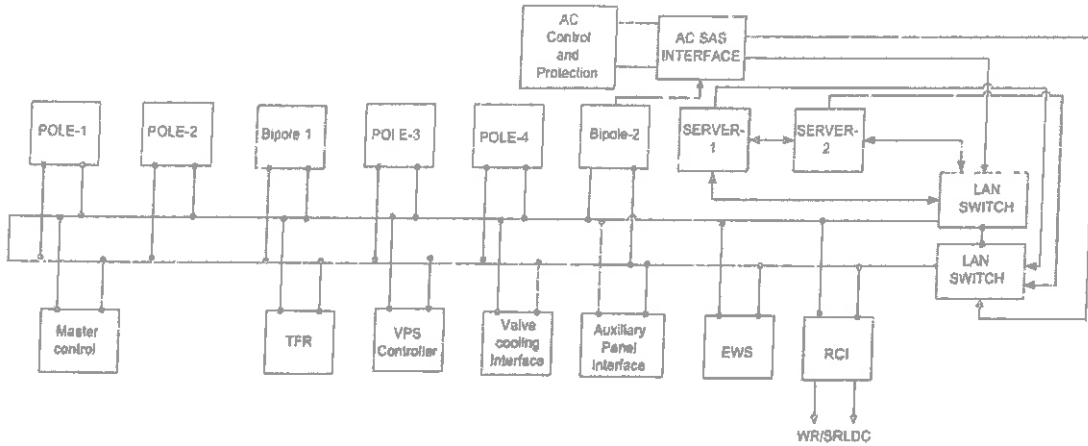

Typical station control and monitoring system

'Figure – A'

(System shall be redundant with system A and system B. Only one system has been represented.)

i. HVDC Controls

The station control room at each converter station shall have facilities that include, but not be limited to, the functions shown on Table-A and B

A description of major HVDC control functions is outlined below:

1. Controlling Station (Master Station) Selector Switch

Control location selector switches shall be provided in each station control room. These selector switches shall enable the operator to control the HVDC system and/or the HVAC yard of any converter station from either Nagpur and KPS2 stations. HVDC and HVAC yard control & monitoring of other converter station shall be provided from TFT Monitors.

2. Bipole Controls

Bipole controls shall refer to the common control functions that affect both poles in a Bipole. These functions are typically Bipole power order, power direction, power limit and power ramp rate.

The power flow over the Bipole shall be maintained at the Bipole power order as set by the operator.

The power ramp rate shall control the timing sequence for loading Bipole at a pre-selected rate (within specified range) set by the operator.

The power limit control shall enable the operator to set different limits to Bipole loading. It shall also be possible to operate each pole separately from Bipole Controls.



3. Pole/Converter Current Order/Limit

The power setting divided by voltage shall determine the current order to either pole. However, this shall not preclude the ability to control each pole, by means of a directly entered manual current order signal.

The pole current limit set point shall enable the operator to raise/ lower current limits to optimize link capabilities under varying conditions such as ambient temperature, temporary reduction in capability etc.

4. HVDC System Control Mode Selection (Per Pole)

The following basic control modes shall be provided:

- a) Power Control Mode
- b) Current Control Mode

Disturbance free transfer of any pole from one control mode to another shall be possible.

5. Miscellaneous Operator Controls

- a) DMR (Dedicated Metallic Return) Line Current Null Control

This control shall enable the operator to null the current flowing in the DMR (Dedicated Metallic Return) Line resulting from unequal sharing of load between poles during balanced operation.

- b) Block/ Deblock

This control shall enable the operator to stop (block) or start (deblock) a converter. Automatic sequences shall be provided to fulfill preconditions for deblock. A normal stopping sequence initiated by "block" contact involves a sequence at each end that causes the voltage and current to drop to zero.

- c) Pole Start/ Stop

This control shall enable start or stop of the complete pole, comprising converters at either of the rectifiers and the inverter and shall take care of all interlocks, start/stop preconditions and sequences automatically.

- d) Direction of Power Transfer

Power flow shall be possible in both directions.

- e) Pole Metallic Return/DMR (Dedicated Metallic Return)/DMR-PMR parallel Mode

This selector switch (or switches) shall enable an automatic sequence from Pole metallic return to DMR and vice versa. This mode change shall be possible even with power flowing in the DC system. It shall also be possible to operate DMR & PMR conductors in parallel.

Central Transmission Utility of India Limited

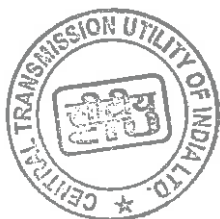

153

Khavda V-A Power Transmission Limited



f) DC Filter Connect/ Isolate

Motorized disconnects are specified for switching the filter arms to allow disconnection of a faulty filter bank or arm and for restoration to service as quickly as possible. An automatic switching sequence shall be provided which shall take care of all the interlocks.

g) DC Line Isolator

DC line isolators are specified for maintenance purposes and their electrical operation in local shall be possible. Operation shall be permitted only with pole blocked and station ground connected. Automatic operation shall also be possible if required by any sequences subject to satisfying all interlocks permitting the operation.

h) Grounding Switches in DC Yard

Grounding switches are specified for the DC switchyard area to allow each isolatable section of bus to be grounded. Only local electrical operation is required. However, if operation of any grounding switches is part of any automatic sequence(s), or is specified elsewhere, then those grounding switch(es) shall be operable locally as well as remotely.

i) Valve Hall Ground Switches

Remotely controlled motor operated grounding switches are specified for the valve halls to protect maintenance personnel. The operation of all the valve hall ground switches together as a group shall be possible by initiating a sequence from the control room. Provision shall however be made (key operated switch) for defeating the interlock to permit entry of authorised personnel into the restricted area of the valve hall.

j) Maintenance/Bypass Isolators for Metallic Return Transfer Switch / Bus (MRTS or MRTB)

Electrically local operated isolators shall be provided to establish a ground reference when MRTS is being maintained. These shall be interlocked with the MRTS.

k) Emergency Stop

An emergency stop button on pole basis shall be provided in the control room. Operation of this button shall automatically ramp down at a fast rate the direct power, lead to blocking of the converters and reach safe shut down with Operation of High speed parallel/ De-parallel switches.

l) HVAC Controls

HVAC controls shall consist of close-open operations for circuit breakers and motor operated disconnectors.

ii. Station Control Facilities

The TSP shall provide the control facilities from the operator control desk through a TFT monitor and keyboard/ mouse system. These facilities shall include all control operations,

Central Transmission Utility of India Limited



154

Khavda V2A Power Transmission Limited



209

digital setting, indicating devices, Station single line diagram and symbols, any other special control devices and meters required for control and monitoring of the complete HVDC system. The layout of the station single line diagram, together with control, indicating and metering devices on the control desk shall be logical, compact, and shall facilitate efficient supervision and operation of the station(s) by the operator.

iii. Station Level Status Supervision

The position of each switchgear e.g. Circuit breaker, isolator, earthing switch, transformer tap changer etc shall be supervised continuously. Every detected change of position shall immediately be displayed in the single-line diagram on the station screen, recorded in the event list and an option to take hard copy printout of event list shall be available. Alarms shall be initiated in the case of spontaneous position changes.

The switchgear positions shall be indicated by two auxiliary switches, normally closed (NC) and normally open (NO), which shall give ambivalent signals. An alarm shall be initiated if these position indications are inconsistent or if the time required for operating mechanism to change position exceeds a predefined limit.

iv. System Indications and Power Measuring Facilities

The TSP shall provide DC and AC system / equipment indication facilities in the station control room at each converter station that shall include, but not be limited to, the functions shown on Table A and Table B. Alarms of slave stations shall be indicated and displayed both at Master Station and slave stations and vice-versa.

3-Dimensional graphic representation of thyristor valves and valve cooling piping network shall be provided on station monitoring system. The graphical representation shall also display faulty thyristors in different colours indicating faulty thyristor position.

Pressure, temperature and relative humidity of each valve hall shall also be displayed in the control room. Alarm(s) shall be raised in case any of the parameters exceed limits.

'Table A' provides a list of minimum AC and DC metering facilities required, which shall be included on TFT monitors.

v. Energy Metering

Energy meters as per relevant CEA Guidelines and Specifications/Regulations for the 765 kV, 400 kV, 220 kV & 132 kV AC switchyards (as applicable) and 33 kV feeders at HVDC terminals shall be provided by the TSP.

Central Transmission Utility of India Limited

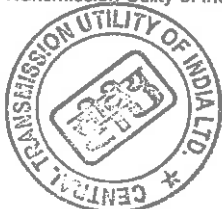

155

210

Khavda V-A Power Transmission Limited



B. System Requirements**General**

The main control and monitoring systems shall be configured as dual redundant computer-based systems in a main and hot standby configuration generally as shown in 'Figure A'. The operator control, monitoring and support system could be integrated with station control system. Outage of any subsystem or complete loss of one system shall not affect the control and monitoring of the HVDC station. The system shall be based on open system concept in hardware and software and industry standard communication protocols and graphical user interface.

The redundant, computer-based system shall accept control inputs from the Operator by means of TFT monitor/ mouse etc and send these commands to the HVDC and the HVAC control systems.

The system shall gather alarm, status and measurand data from the plant and display it to the Operator on the mimic diagram on TFT monitors, loggers etc as further defined below. The system shall be so designed that no alarm and status data or control data shall be lost.

Table -A Controls & Indications at Nagpur and KPS2: -

Sl. No.	Signal Name	Nagpur	KPS2
	CONTROLS SIGNALS		
1.	Bipole power order	√	√
2.	Bipole power order ramp	√	√
3.	Bipole power order limit	√	√
4.	Bipole power/current control	√	√
5.	Power direction P1.P3, P2.P4	√	√
6.	Power/Current control P1.P3,P2.P4	√	√
7.	Current order setting	√	√
8.	Current ramp start/stop	√	√
9.	Current order ramp setting	√	√
10.	Current limit setting	√	√
11.	Master station transfer	√	√
12.	Metallic/DMR switching	√	√
13.	Reduced voltage on/off P1, P2, P3, P4	√	√
14.	Start/Stop & Block/deblock P1, P2, P3, P4	√	√
15.	Power Swing modulation on/off	√	√



Transmission Service Agreement

Sl. No.	Signal Name	Nagpur	KPS2
16.	DC power /current control	√	√
17.	Emergency stop P1, P2, P3, P4	√	√
18.	Frequency control/on/off	√	√
19.	Frequency target/limits	√	√
20.	Connect/isolate P1, P2, P3, P4	√	√
21.	Joint/separate, Sync/Async	√	√
22.	DC Filter connect/isolate P1, P2, P3, P4	√	√
23.	RPC auto/man off switching	√	√
24.	RPC Volt/Reactive Selection	√	√
25.	RPC MVar/Voltage set points	√	√
26.	Open line test auto/man P1.P3, P2.P4	√	√
27.	AC Filter (bank/ sub-bank) breaker open/close	√	√
28.	Conv.Trans Breaker open/close	√	√
29.	AC Filter (bank/sub-bank) Disconn open/close	√	√
30.	Con. Trans Disconn open/close	√	√
31.	Tap changer auto/man P1, P2, P3, P4	√	√
32.	Valve hall Gr. Switch open/close P1, P2, P3, P4	√	√
33.	Nagpur Sw. yard Breaker open	√	√
34.	KPS2 Sw. yard Breaker open	√	√
	INDICATIONS		
35.	DC OP Mode Pwr./current	√	√
36.	Gr/metallic return indication. P1.P3, P2.P4	√	√
37.	Power direction P1.P3, P2.P4	√	√
38.	Pole Telecommunication healthy	√	√
39.	Pole blocked/deblock P1, P2, P3, P4	√	√
40.	Master station Nagpur-KPS2- LDC	√	√
41.	DC Station overload in use	√	√
42.	Power ramp in progress	√	√
43.	Stabilization control on/off	√	√
44.	Full/reduced DC voltage indication. P1.P3, P2.P4	√	√
45.	Tap changer Auto/Man indication.	√	√
46.	Pole connect/isolate indication.	√	√
47.	Power direction normal/reverse	√	√
48.	Runback activated indication.	√	√
49.	Frequency control on/off	√	√

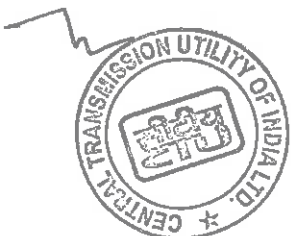

Sl. No.	Signal Name	Nagpur	KPS2
50.	Frequency control activated	√	√
51.	AC bay Circuit breakers indication.	√	√
52.	AC bay disconnectors indication.	√	√
53.	AC Filter (Sub-bank) Circuit breaker indication	√	√
54.	AC Filter (Sub-bank) disconnector indication.	√	√
55.	DC filter con/isolated indication.	√	√

Table -B Indication Signals to RLDC

S.No	Signal Name	RLDC
1.	Bipole power order	√
2.	Power Swing modulation on/off	√
3.	DMR/metallic return indication. P1.P3, P2.P4	√
4.	Pole blocked/deblock P1, P2, P3, P4	√
5.	Runback activated indication.	√
6.	Frequency control on/off	√
7.	Frequency control activated	√
8.	Full/reduced DC voltage indication.	√
9.	AC bay Circuit breakers indication.	√
10.	AC bay disconnectors indication.	√
11.	DC Power Bipole	√
12.	DC Line current/ voltage P1.P3, P2.P4	√
13.	AC side A/MW/MVAR/ P1, P2, P3, P4	√
14.	AC Filter/Cap A. Mvar all banks	√
15.	AC Lines A/MW/MVAR/	√
16.	Station/AC system MW exchange	√
17.	Station/AC System MVAR exch.	√
18.	AC Bus Voltage	√
19.	AC Bus Frequency	√

The system shall also be designed to allow input of signals from the Dispatch centre - for example, load frequency control (LFC) signals. The system shall be capable of meeting the control and monitoring requirements of each converter station and LDC while operating at maximum rating, with a reserve capacity of minimum twenty-five per cent. Equipment bins that are not fully equipped with cards shall be fully wired and be ready to accept additional cards. Power supply units shall be rated to meet the full capacity requirements.



C. Functional Requirements

1. General

The redundant computer-based system shall be a highly reliable integrated system, which shall provide Operator's interface, alarm and monitoring system and operator guidance/ expert system.

The high-voltage apparatus within the station shall be operated from different places:

- Remote control centres
- Station operator control.
- Local Bay controller IED (in the bays)

Operation shall be possible by only one operator at a time. The operation shall depend on the conditions of other functions, such as interlocking, synchro-check etc.

2. Run Time Command Cancellation and Self-Supervision

Command execution timer (configurable) must be available for each control level connection. If the control action is not completed within a specified time, the command should get cancelled. Continuous self-supervision function with self-diagnostic feature shall be included.

3. User Configuration

The monitoring, controlling and configuration of all input and output logical signals and binary inputs and relay outputs for all built-in functions and signals shall be possible both locally and remotely.

It shall also be possible to interconnect and derive input and output signals, logic functions, using built-in functions, complex voltage and currents, additional logics (AND-gates, OR gates and timers). (Multi-activation of these additional functions should be possible).

The Functional requirement shall be divided into following levels:

- a) Bay Level Functions.
- b) System Level Functions.

D. Computer Information System Requirement:

A computer-based information system shall perform following functions:

- Initiation of commands to control HVDC system.
- Control and monitor the Valve cooling system.
- Monitoring of process data to give brief overview as well as a comprehensive view of each subsystem.

Central Transmission Utility of India Limited

159

Khavda V-A Power Transmission Limited

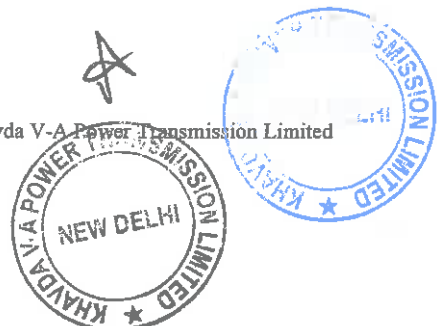

214

- Sequence of event recording and alarm system including determination of Event Categories (major, warning, alarm).
- Process data archiving and trending.

Soft copy of complete station documentation shall be available on Operator Work Stations.

All the system trends shall be available at least for one-year period and retrievable on demand from the main storage system. The process data logging shall have hourly/ daily logging of station data. Archiving and back up storing facility of the log sheets shall be possible and facilities taking backup on External hard discs/ Drives minimum 2 tera bytes shall be provided.

E. Remote Control, Monitoring and Tele Control systems

The TSP shall provide facilities for coordinated control and monitoring of the HVDC system. All required remote control and remote monitoring facilities shall be provided at each converter station. Complete remote monitoring of each converter station shall be possible from opposite converter station. The HVDC tele-control system equipment shall be used in the processing of signals to be transmitted over the fibre optic communication system between the converter stations of Bipolar scheme.

Central Transmission Utility of India Limited



215

Khavda V-A Power Transmission Limited



A

Transient Fault Recorders**1. General**

The transient fault recorders (TFR) shall continuously monitor the power system. These could be integrated with operator control and monitoring system or supplied as standalone units.

Below requirements are specified for standalone units. Similar functional requirements will be applicable for integrated TFR.

One recorder per pole shall be provided at each converter station. The TFR may be provided in the form of central unit together with Data Acquisition Units (DAUs). Initiation by any one of the fault detecting sensors or external initiating contacts shall cause the fault recorder to record on all channels. The record shall comprise-fault information, time of fault information and post fault information. The TSP shall determine the number of analog and event inputs required for each recorder and supply these number plus minimum 25% spare channels. The TFR shall also have facility for harmonic analysis upto 50th harmonics of waveforms. Recorders shall be of solid-state modular construction microprocessor based and without moving parts. First in, first out (FIFO) printing logic shall be used. The necessary software for directly analyzing the records on the memory of the TFR shall also be supplied.

Facilities shall also be provided for data retrieval from TFR and analyse by means of a master station based on compatible PC having minimum configuration of 2.8 GHz clock speed, 1 TB hard disc & 16 GB RAM capacity, complete with 24-inch LED monitor, keyboard/ mouse etc and include laser colour printer with capability to print on A3 and A4 size paper. All necessary software package(s) along with facility to communicate between TFR & PC shall be provided by the TSP.

2. Input Signals

The input signals and starting sensors required for the HVDC system for commissioning and operation shall be determined by the TSP. The input signals to each fault recorder system for a pole shall include, but not be limited to, the following:

- Valve group firing pulse markers;
- Valve group ignition delay angle response;
- Valve group voltage;
- Pole current order;
- DC line voltage (own pole);
- DC line voltage (other pole);
- DC neutral Bus voltage (Both poles)
- DC line current (own pole);

Central Transmission Utility of India Limited

161

Khavda V-A Power Transmission Limited

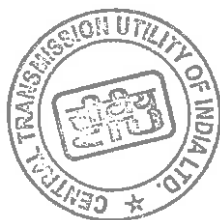

216

- DC line current (other pole);
- DC power (each pole and both converters)
- DC power (other pole and both converters)
- Current order
- AC bus voltage (3 phases);
- AC current to each valve group and transformer primary currents.

The Triggering of TFR shall include, but not be limited to following inputs:

- Pole Block/ Deblock
- Pole Commutation Fail
- Pole Firing pulse loss
- Pole last Breaker opened
- Pole DC Protection Voltage level trigger
- Pole DC Protection dv/dt trigger
- Pole di/dt
- Pole 30 minutes, 2 hours and 5 seconds overload operated
- Pole MR/ GR sequence initiated
- AC Over voltage/ under voltage Protection operated.
- Full voltage/ RVO Changeover
- Idc Limit by VDCOL
- DC O/V, U/V
- Telecommunication Fail

Each fault recorder shall be equipped with suitable input circuits and starting sensors for all of the input signals. The TSP shall ensure that the characteristics of the input circuits and starting sensors are well matched to the characteristics of the signal sources.

3. Electrical Characteristics

(i) Monitoring Systems

The recorder shall be a digital based type. Operation of the equipment shall be based on programs stored in non-volatile solid-state memory. Programs shall be stable and no inadvertent change of program(s) shall occur.

The recorder shall be equipped with a built-in post fault record- length timer, adjustable over a range of 0.5 to 10 seconds after the fault.

Normally open operation alarm contacts shall close while the fault recorder system is operating and be utilized as inputs to the alarm monitoring and reporting system. A three digit,



217

manually resettable operations counter shall be provided that indicates the number of faults or disturbances recorded.

Facility for automatic storage of information to a PC or an independent storage device (e.g. a disc drive) shall be provided. The output shall be possible to be printed on plain paper in the A4/A3 format.

The recorded information shall include but not necessarily be limited to:

- Station Identification
- Identity of trigger source
- Record Identification for Analog, Event and Sensor traces
- Date/ Time: Year, Day, Hour, Minute, Second, Millisecond
- Analog traces
- Event traces
- Sensor traces
- Time marker trace which shall allow time interpolation of records to 2 ms.
- Start of record line.

(ii) Operations

The fault recorder shall continuously monitor the power system. Initiation by fault detecting sensors or by other input contacts or pre-selected events shall cause that particular recorder to record the fault information. The other pole recorder shall also record in a slave mode. Operation of any one of the initiating sensors shall start the recording mechanism or otherwise cause all channels to record until the fault clears or the record-length timer setting is exceeded.

The transient fault recorder shall have facility for suitable interface for transmission of recorded analog and digital information to a remote station. This shall be demonstrated by the TSP at site by using inter-station communication.

(iii) Input Circuitry

The input circuits for the recording channels shall be insulated for operation at potentials of 2000 Vrms between channels and between channel and ground. Each input recording channel shall be capable of operating from the output of 1A rms nominal secondaries of current transformers and capacitive voltage transformers with 63.5 V rated secondary. Each channel shall be supplied with a selection of current shunts and voltage multipliers to provide a range of high and low current or voltage ranges which can be selected by straps or similar method. The recorder shall also be capable of operating from the DCCT's and direct voltage devices supplied for the station. Any device required for processing of input signals in order to make them compatible to the equipment shall form an integral part of the supplied equipment. However, such processing of input signals shall in no way distort its waveform. The equipment shall be carefully screened, shielded, earthed and protected as may be required for

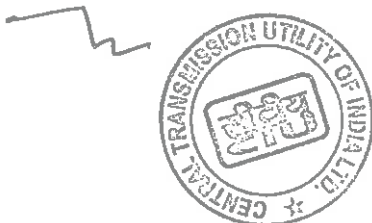

218

its safe functioning. It shall be possible to position the reference point of any of the analog channels to any position on the record. The individual traces shall be identified on the record by numbering them in the order they are connected at the input.

The current values of scaling parameters related to the various channels shall be printed on each printout to enable quick interpretation of the records.

(iv) Starting Sensors

The initiating or detecting devices, which start the recording, shall be solid state and automatic self-resetting type.

Each sensor shall be equipped with an indicating lamp, viewable from the front of the cabinet, which operates when the sensor operates. The lamp shall remain 'on' until reset by the station operator. Failure to reset the lamp shall not affect subsequent operation of the sensor. Sensor settings shall be easily adjustable and easily accessible. One starting sensor for at least each of the following types of changes shall be provided.

- Level Changes Over Current Over Voltage Under voltage
- Swing Rate of change of nominal input
- Frequency
- Under frequency
- Over frequency

It shall be possible to adjust the response time of the sensors, in each case, to ensure the most rapid operation consistent with the characteristics of the analogue quantity being monitored.

It shall also be possible to initiate the fault recording, as required, by additional external relay contacts, either NO or NC.

(v) Pre-fault Periods

The recording system shall accurately record power system transient disturbances with a pre-fault period, which shall be settable between 50 to 250 ms.

(vi) Memories

Sufficient memory shall be provided to prevent any loss of records under all normal operating circumstances.

(vii) Time

A means shall be provided to record on the chart the time of occurrence of each fault or disturbance to a resolution of 2 milliseconds or better. The time clock shall be synchronized with the station master clock signal. Facility shall exist to display the time in hour, minutes and seconds on the front of the panel.

Central Transmission Utility of India Limited



(viii) Calibrations

The recording system shall be so designed that each channel may be calibrated separately. Calibration shall be accomplished by applying the calibration level input in the test switches. Controls and switches shall be provided on the front panel to facilitate calibration.

(ix) Resolutions

a) Analog resolution

Analog to digital conversion shall be 12 bits (minimum). The amplitude of the recording shall be adjustable and magnification in fixed steps, of the recording, shall be provided.

b) Events Resolution

The event resolution at the lowest scan rate shall be two milliseconds or better.

c) Transient Response (analog channels)

The transient response delay of the analog input conditioning circuits to a step function input shall be less than 400 microseconds between 10% and 90% values of the step function with overshoot of the final value of the step function being not more than 2%.

(x) Recording Quality

Static trace width	1.5 mm maximum
Residual channel noise	0.1% of full-scale maximum at 50 Hz or any harmonic thereof
Recording resolution	0.1% of full scale
Phase error between channels	Less than 5 degrees at 50 Hz
Crosstalk	Lower than 50 dB (DC to 1500 Hz)

Scale alteration/ expansion facilities shall be provided.

(xi) Alarm Circuits and Indicators

Alarm circuits shall be provided to indicate inability for automatic operation due to power failure, out of paper condition, incorrect switch positioning or other failure(s), which shall be prominently visible on the recorder panel. Each alarm circuit shall include a normally open contact which shall be integrated into the station alarm monitoring and reporting system.

(xii) Power Requirements

The recording system shall be suitable for operation from the station battery supply. There shall be no loss of accuracy in the recording system for specified variations of DC input voltage.

Central Transmission Utility of India Limited

165

Khavda V-A Power Transmission Limited



220

DEFINITIONS

OUTAGE TERMS

1. Outage

The state in which equipment or a unit of equipment is unavailable for normal operation due to an event directly related to the same equipment or some unit of equipment.

2. Scheduled Outage

Scheduled outage is an outage which can be scheduled at least one week in advance. This includes planned maintenance, normally conducted on annual basis, and also unplanned maintenance or repair which can be deferred at least one week subsequent to discovery of the need for maintenance or repair. If the outage is extended due to additional work which would have otherwise caused a forced outage, the excess period is counted as a forced outage.

3. Forced Outage

The state in which equipment is unavailable for normal operation, but is not in the scheduled outage state, i.e. an outage which is not a scheduled outage.

4. Pole Outages

An outage which causes a reduction in the Bipole DC power system transfer capacity equal to or less than the power rating of one pole

5. Bipole Outages

An outage which causes a reduction in the bipolar DC system power transfer capacity greater than the power rating of one pole

CAPACITY TERMS

1. Maximum Continuous Capacity (Pm)

The maximum bipolar HVDC system capacity (MW) for which continuous operation under normal conditions is possible referred on to the rectifier DC bus, i.e. 3000 MW.

Central Transmission Utility of India Limited



166



2. Outage Capacity (Po)

The capacity reduction in MW which the outage would have caused if the HVDC system were operating at its maximum continuous capacity (Pm) at the time of the outage.

3. Outage Derating Factor (ODF)

The ratio of outage capacity (Po) to maximum continuous capacity (Pm). $ODF = Po/Pm$

OUTAGE DURATION TERMS

1. Actual Outage Duration (AOD)

The time elapsed in hours between the start and the end of an outage. The time shall be counted to the nearest 1/10th of an hour. Time less than 1/10 of an hour shall be counted as having duration of 1/10 of an hour.

2. Equivalent Outage Duration (EOD)

The actual outage duration (AOD) in hours, multiplied by the outage derating factor (ODF), so as to take account of partial loss of capacity.

$$EOD = AOD \times ODF$$

Each equivalent outage duration may be classified according to the type of outage involved, i.e. equivalent forced outage duration (EFOD) and equivalent scheduled outage duration (ESOD).

TIME CATEGORIES

1. Period Hours (PH)

The number of hours in the reporting period.

In a full year the Period Hours are 8760 h (8784 h for a leap year). If the equipment is commissioned part way through a year, the period hours shall be proportionately less than 8760 h. (This shall not be applicable for verification of guarantees).

2. Actual Outage Hours (AOH)

The sum of actual outage durations within the reporting period

$$AOH = \sum AOD$$

The actual outage hours (AOH) may be classified according to the type of outage involved, i.e. AFOH and ASOH.

Central Transmission Utility of India Limited



167

Khavda V-A Power Transmission Limited



222

3. Equivalent Outage Hours (EOH)

The sum of all equivalent outage durations within the reporting period.

$$EOH = \sum EOD$$

The equivalent outage hours may be classified according to the type of outage involved, i.e. equivalent forced outage hours (EFOH) and equivalent scheduled outage hours (ESOH).

If outage duration overlaps the beginning or end of a reporting period, only the EOD which lie within the reporting period shall be included in EOH.

AVAILABILITY AND RELIABILITY TERMS

1. Energy Unavailability (EU)

Energy unavailability is a measure of the energy which could not have been transmitted due to (scheduled & forced) outages. The impact of overload capability of the individual poles shall not be considered for calculating the Energy unavailability.

$$\text{Energy Unavailability \% (EU)} = EOH/PH \times 100$$

$$\text{Forced Energy Unavailability \% (FEU)} = EFOH/PH \times 100$$

$$\text{Scheduled Energy Unavailability \% (SEU)} = ESOH/PH \times 100$$

2. Energy Availability (EA)

A measure of the energy which could have been transmitted except for limitations of capacity due to outages, arising from any cause, either forced or scheduled.

$$\text{Energy Availability \% (EA)} = (100 - EU)$$

3. Energy Utilisation (U)

A factor giving a measure of energy actually transmitted over the system.

$$\text{Energy Utilisation \% (U)} = [\text{Total energy transmitted} / (\text{Pm} \times \text{PH})] \times 100$$



223



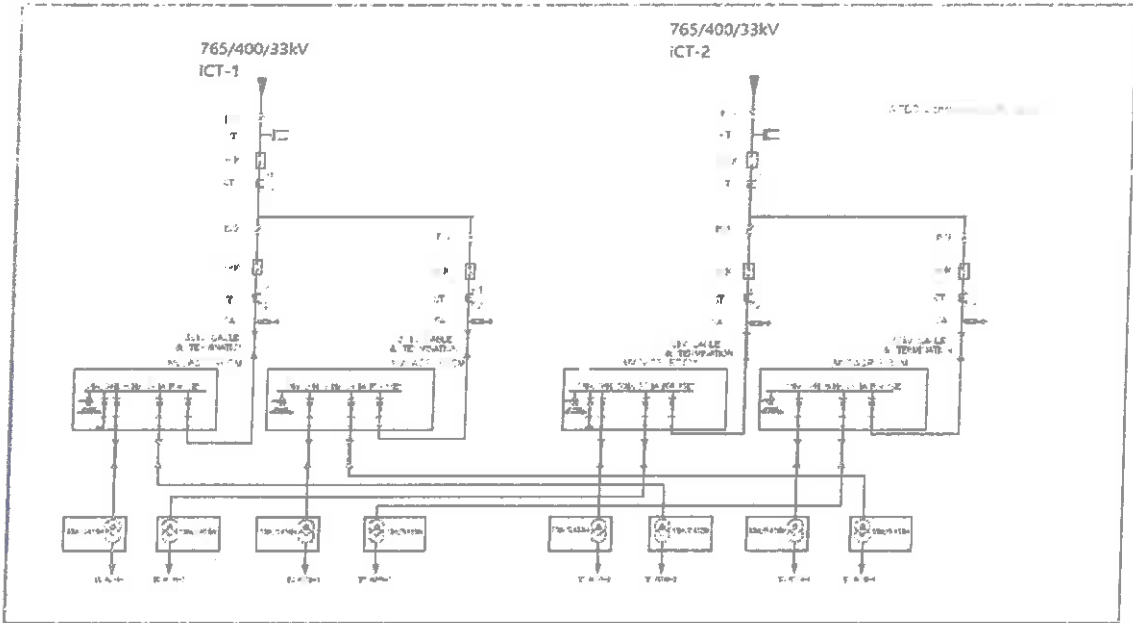

Central Transmission Utility of India Limited

Khavda V-A Power Transmission Limited



SPECIFIC TECHNICAL REQUIREMENTS FOR HVDC TRANSMISSION LINE

- A.1.0 The design, routing and construction of HVDC transmission lines shall be in accordance with CEA (Technical Standards for Construction of Electrical Plants and Electric Lines) Regulations 2022, as amended from time to time.
- A.2.0 Selection of tower type shall be made as per CEA Regulations, however in case lattice type towers are used, the following shall also be applicable:
- A.2.1 Steel section of grade E 250 and/or grade E 350 as per IS 2062, only are permitted for use in towers, extensions, gantry structures and stub setting templates. For towers in snowbound areas, steel sections shall conform to Grade-C of IS-2062.
- A.2.2 Towers shall be designed as per IS-802:2015, however the drag coefficient of the tower shall be as follows: -

Solidity Ratio	Drag Coefficient
Upto 0.05	3.6
0.1	3.4
0.2	2.9
0.3	2.5
0.4	2.2
0.5 and above	2.0

- A.3.0 Transmission Service Provider (TSP) shall adopt any additional loading/design criteria for ensuring reliability of the line, if so desired and /or deemed necessary.
- A.4.0 Transmission line shall be designed considering wind zones as specified in wind map given in National Building Code 2016, Vol.1. The developer shall also make his own assessment of local wind conditions and frequent occurrences of high intensity winds (HIW) due to thunderstorms, dust-storms, downburst etc. along the line route and wherever required, higher wind zone than that given in wind map shall be considered for tower design for ensuring reliability of line. Further, for transmission line sections passing within a distance of 50 km from the boundary of two wind zones, higher of the two wind zones shall be considered for design of towers located in such sections.
- A.5.0 Selection of reliability level for design of tower shall be as per CEA Regulation (Technical Standards for Construction of Electrical Plants and Electric Lines) Regulations 2022, as amended from time to time.

Central Transmission Utility of India Limited

170

Khavda V-A Power Transmission Limited

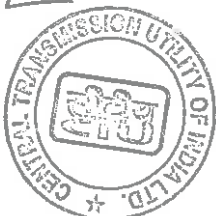

- A.6.0 A) For power line crossing of 400 kV or above voltage level (if crossed over the existing line), large angle & dead-end towers (i.e. D/DD/QD) shall be used on either side of power line crossing.
- B) For power line crossing of 132 kV and 220 kV (or 230 kV) voltage level, angle towers (B/C/D/DB/DC/DD/QB/QC/QD) shall be used on either side of power line crossing depending upon the merit of the prevailing site condition and line deviation requirement.
- C) For power line crossing of 66 kV and below voltage level, suspension/tension towers shall be provided on either side of power line crossing depending upon the merit of the prevailing site condition and line deviation requirement.
- D) For crossing of railways, national highways and state highways, the Rules/Regulations of appropriate authorities shall be followed.

A.7.0 The relevant conductor configuration shall be as follows: -

- i. Type of conductor: ACSR / AAAC / AL59

Basic parameters for Transmission Line associated with HVDC Bipole link:

Transmission line	ACSR Conductor	AAAC conductor based on 53% conductivity of AL Alloy (Size as per IEC-1089)	Minimum size of AL59 conductor based on 59% conductivity of AL Alloy (Size as per Swedish -SS-420814)(option 1)	Minimum size of AL59 conductor based on 59% conductivity of AL Alloy (Size as per Swedish -SS-420814) (option 2)	Sub-conductor Spacing
+800 kV HVDC transmission lines (hexa bundle configuration per pole)	Lapwing: Stranding 45/4.78 mm-Al + 7/3.18 mm- Steel; 38.22 mm diameter; 807.5 sq. mm, Aluminium area;	Stranding details: 61/4.38mm, 39.5 mm diameter; 921 sq.mm Aluminium alloy	Stranding details: 61/4.36mm, 39.2 mm diameter; 910 sq.mm Aluminium alloy	Stranding details: 61/4.17 mm, 37.53 mm diameter; 833 sq.mm	457 mm

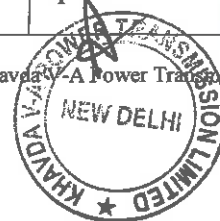
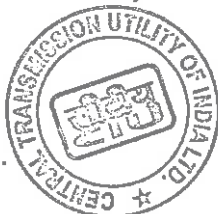

226

Transmission Service Agreement

Transmission line	ACSR Conductor	AAAC conductor based on 53% conductivity of AL Alloy (Size as per IEC-1089)	Minimum size of AL59 conductor based on 59% conductivity of AL Alloy (Size as per Swedish -SS-420814)(option 1)	Minimum size of AL59 conductor based on 59% conductivity of AL Alloy (Size as per Swedish -SS-420814) (option 2)	Sub-conductor Spacing
	Maximum DC Resistance at 20°C (Ω/km): 0.0358; Minimum UTS: 188.0 kN	area; Maximum DC Resistance at 20°C (Ω/km): 0.0361; Minimum UTS: 244.0 kN	area; Maximum DC Resistance at 20°C (Ω/km): 0.0326; Minimum UTS: 199.0 kN	Aluminium alloy area; Maximum DC Resistance at 20°C (Ω/km): 0.0356; Minimum UTS: 181.96 kN	

Central Transmission Utility of India Limited

172

Khavda V-A Power Transmission Limited

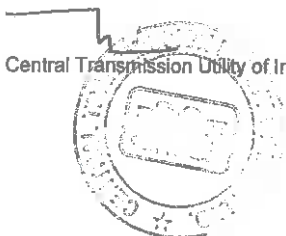

227

Transmission Service Agreement

Transmission line	ACSR Conductor	AAAC conductor based on 53% conductivity of AL Alloy (Size as per IEC-1089)	Minimum size of AL59 conductor based on 59% conductivity of AL Alloy (Size as per Swedish -SS-420814)(option 1)	Minimum size of AL59 conductor based on 59% conductivity of AL Alloy (Size as per Swedish -SS-420814) (option 2)	Sub-conductor Spacing
Twin Lapwing transmission lines for DMR (2 Nos. Dedicated Metallic Return line with Twin bundle configuration)	Lapwing: Stranding 45/4.78 mm-Al + 7/3.18 mm-Steel; 38.22 mm diameter; 807.5 sq. mm Aluminium area; Maximum DC Resistance at 20°C (Ω/km): 0.0358; Minimum UTS: 188.0 kN	Stranding details: 61/4.38mm, 39.5 mm diameter; 921 sq.mm Aluminium alloy area; Maximum DC Resistance at 20°C (Ω/km): 0.0361; Minimum UTS: 244.0 kN	Stranding details: 61/4.36mm, 39.2 mm diameter; 910 sq.mm Aluminium alloy area; Maximum DC Resistance at 20°C (Ω/km): 0.0326; Minimum UTS: 199.0 kN	Stranding details: 61/4.17 mm, 37.53 mm diameter; 833 sq.mm Aluminium alloy area; Maximum DC Resistance at 20°C (Ω/km): 0.0356; Minimum	450 mm

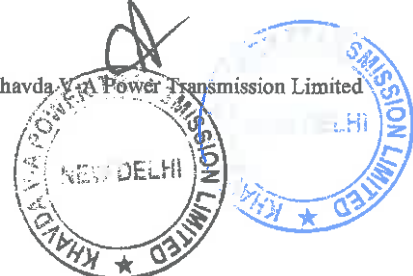

Transmission line	ACSR Conductor	AAAC conductor based on 53% conductivity of AL Alloy (Size as per IEC-1089)	Minimum size of AL59 conductor based on 59% conductivity of AL Alloy (Size as per Swedish -SS-420814)(option 1)	Minimum size of AL59 conductor based on 59% conductivity of AL Alloy (Size as per Swedish -SS-420814) (option 2)	Sub-conductor Spacing
				UTS: 181.96 kN	

Note: The transmission lines shall have to be designed for a maximum operating conductor temperature of 85 deg C.

- A.8.0 The required pole to pole spacing shall be governed by the tower design as well as minimum live metal clearances under different insulator swing angles. However, the spacing between Pole and DMR shall not be less than 9.7 m and pole to pole clearance shall not be less than 22.0 m.
- A.9.0 All electrical clearances including minimum live metal clearance, ground clearance and minimum mid span separation between earth wire and conductor shall be as per Central Electricity Authority (Measures Relating to Safety & Electric Supply) Regulations, 2023 as amended from time to time and relevant Indian Standards. For the Clearances are not included in CEA Regulation/ Indian Standard, following values shall be considered:

Central Transmission Utility of India Limited

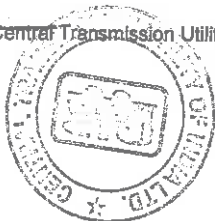

174

Khayda V-A Tower Transmission Limited



1) **Minimum live metal clearances for ± 800 kV line:**

a.(i) Swings and Clearances:

Wind pressure Condition	Minimum electrical clearance
a) Swing angle (0°)	7.7 m
b) Swing angle (21°)	6.5 m
c) Swing angle (53°)	2.0 m

a.(ii) Swings and Clearances: For Jumper

Wind pressure Condition	Minimum electrical clearance
a) Swing angle (0°)	7.7 m
b) Swing angle (25°)	6.5 m
c) Swing angle (72°)	2.0 m

a.(iii) Swings and Clearances: For Jumper with pilot insulator

Wind pressure Condition	Minimum electrical clearance
a) Swing angle (0°)	7.7 m
b) Swing angle (25°)	6.5 m
c) Swing angle (66°)	2.0 m

b) (i) Minimum ground clearance for AL 59 conductor (61/4.17 mm, 37.53 mm diameter): 19 m

c) (ii) Minimum ground clearance: 18 m

c) Minimum mid span separation between earth wire and Pole conductor: 12.0 m

2) **Minimum live metal clearances for DMR line:**

a) Swings and Clearances:



Central Transmission Utility of India Limited

175

Khavda V-A Power Transmission Limited

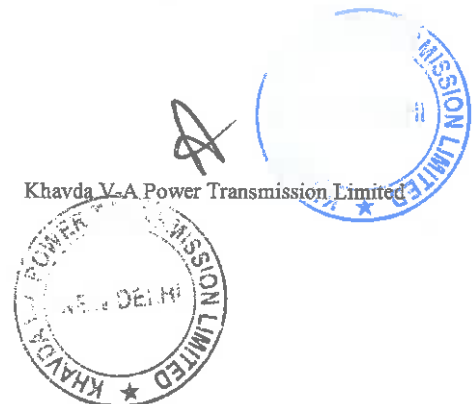
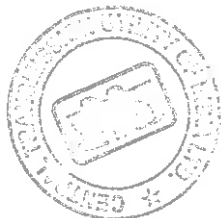

Wind pressure Condition	Minimum electrical clearance
a) Swing angle (0°)	1.53 m
b) Swing angle (15°)	1.53 m
b) Swing angle (30°)	1.37 m
d) Swing angle (45°)	1.22 m
e) Swing angle (60°)	1.07 m

b) Minimum mid span separation between earthwire and DMR conductor: 6.1 m

A.10.0 Shielding angle shall not exceed 10 deg for Pole and 30 deg for Dedicated Metallic Return.

A.11.0 At least one out of two earth wires shall be OPGW and second earth wire, if not OPGW, shall be either of galvanized standard steel (GSS) or AACSR or any other suitable conductor type depending upon span length and other technical consideration. However, minimum size of galvanized stranded steel (GSS) shall be 7/4.5 mm & diameter 13.50 mm.

A.12.0 Each tower shall be earthed such that tower footing impedance does not exceed 10 ohms. Pipe type or Counterpoise type earthing shall be provided in accordance with relevant IS. Additional earthing shall be provided on every 7 to 8 km distance for direct earthing of both shield wires. If site condition demands, multiple earthing or use of earthing enhancement compound shall be used.

A.13.0 Pile type foundation shall be used for towers located in river or creek bed or on bank of river having scourable strata or in areas where river flow or change in river course is anticipated, based on detailed soil investigation and previous years' maximum flood discharge of the river, maximum velocity of water, highest flood level, scour depth & anticipated change in course of river based on river morphology data of at least past 20 years to ensure availability and reliability of the transmission line.

A.14.0 Transmission line route shall be finalized, in consultation with appropriate authorities so as to avoid the habitant zones of endangered species and other protected species. Bird diverters, wherever required, shall be provided on the line. In order to optimize the route use of GATISHAKTI platform shall also be made.

A.15.0 The transmission lines shall be designed with porcelain/glass/ Composite Insulators as per site pollution severity level in the concerned area. However, minimum creepage distance and insulator length shall be as per follows:

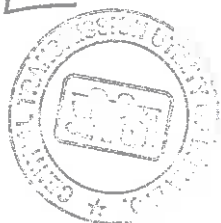

Transmission Service Agreement

Sl. No.	Description	Type of Insulator	Insulator for ±800 kV HVDC Transmission Lines	Insulator for 132 kV Dedicated Metallic Return Conductor
1.	Minimum Creepage Distance for both Light and medium as well as for Heavy and very heavy pollution level	Composite Insulator	50400 mm	8000 mm
	Minimum Creepage Distance for Light and medium pollution level	Porcelain/ Glass Insulator	37760 mm	5550 mm
2.	Minimum length of insulator	--	As per design requirement	2550 mm

A.16.0 Wherever, transmission lines are passing through cyclone prone areas (i.e. areas upto 60 km from coast)/ creek regions/ aggressive soil areas following shall also be applicable:

- a) The fabricated tower parts and stubs shall have a minimum overall zinc coating of 900 gram/m² of surface area except for plates and sections below 5 mm thickness which shall have a minimum overall zinc coating of 610 gram/m² of surface area. The average zinc coating for all sections and plates of 5 mm and above thickness shall be maintained as 127 microns and that for plates and sections below 5 mm shall be maintained as 87 microns.
- b) Ready mix concrete of M30 Grade shall be used to avoid use of locally available saline water. However, design mix concrete of M30 Grade conforming to IS 456 with potable water can be used at locations where transportation of ready-mix concrete is not feasible. Minimum cement content in any case shall not be less than 330 kg/m³.
- c) The surface of the reinforced steel shall be treated with epoxy-based coating to enhance corrosion performance of foundation. Use of epoxy coated reinforcement in foundation shall be as per IS 13620. In addition, two (2) coats of bituminous painting of minimum 1.6 kg/m² per coat shall be applied on all exposed faces of foundation (i.e. pedestal & base slab).
- d) Double coat of 20 mm thick cement plaster shall be provided on all exposed concrete surface up to 300 mm below ground level to give protection to concrete surface from environmental and saline effect.

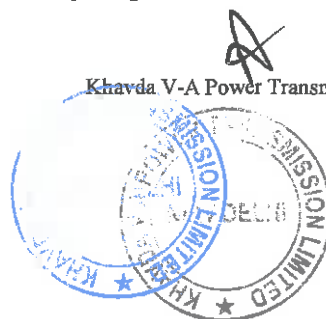

- e) Before coping of chimney top portion, three coats of anti-corrosive paint of minimum 30-35 microns dry film thickness each shall be applied on the stub in the 50 mm coping portion as well as up to 350 mm above CL portion.
- A.17.0 The raised chimney foundation is to be provided in areas prone to flooding/water stagnation like paddy field /agricultural field & undulated areas to avoid direct contact of water with steel part of tower. The top of the chimney of foundation should be at least above HFL (High Flood Level) or the historical water stagnation/ logging level (based on locally available data) or above High Tide Level or 500 mm above Natural Ground level (whichever is higher).
- A.18.0 Wherever, transmission lines are passing through cyclone prone areas i.e. areas up to 60 km from coast following shall also be applicable:
- a) Terrain category-I, with terrain roughness factor (K2) of 1.08 shall be considered for tower design for exposed open terrain with few or no obstruction, which also includes open sea coasts, open stretch of water, desert and flat treeless plains.
 - b) Importance factor for cyclonic region (K4) of 1.3 shall be considered for tower design.
 - c) The number of consecutive spans between the section points/ angle point shall not exceed 10 spans or 3 km instead of conventional practice of 15 spans or 5 km, in order to reduce the failure of such towers in coastal areas due to cascading effect. The section shall be terminated with tension tower/ angle tower and angle of deviation should be based on the site requirement.
- A.19.0 The TSP shall abide by the Guidelines of CEA w.r.t. shifting of transmission lines for NHAI projects and other projects.
- A.20.0 Safety precautions in regards to gas/oil pipe lines in vicinity of Transmission lines shall be taken in coordination with gas/ petroleum authorities.

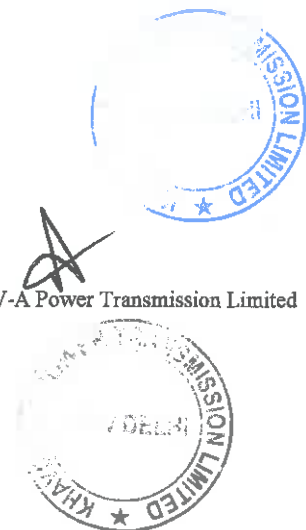
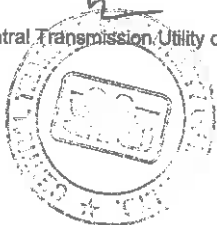

SPECIFIC TECHNICAL REQUIREMENTS FOR HVAC TRANSMISSION LINE

- A.1.0 The design, routing and construction of transmission lines shall be in accordance with Chapter V, Part A of CEA (Technical Standards for Construction of Electrical Plants and Electric Lines) Regulations 2022, as amended from time to time. Other CEA Regulations and MoP guidelines, as applicable, shall also be followed.
- A.2.0 Selection of tower type shall be made as per CEA Regulations, however in case lattice type towers are used, the following shall also be applicable:
- A.2.1 Steel section of grade E 250 and/or grade E 350 as per IS 2062, only are permitted for use in towers, extensions, gantry structures and stub setting templates. For towers in snowbound areas, steel sections shall conform to Grade-C of IS-2062.
- A.2.2 Towers shall be designed as per IS-802:2015, however the drag coefficient of the tower shall be as follows: -

Solidity Ratio	Drag Coefficient
Upto 0.05	3.6
0.1	3.4
0.2	2.9
0.3	2.5
0.4	2.2
0.5 and above	2.0

- A.3.0 Transmission Service Provider (TSP) shall adopt any additional loading/design criteria for ensuring reliability of the line, if so desired and /or deemed necessary.
- A.4.0 Transmission line shall be designed considering wind zones as specified in wind map given in National Building Code 2016, Vol.1. The developer shall also make his own assessment of local wind conditions and frequent occurrences of high intensity winds (HIW) due to thunderstorms, dust-storms, downburst etc along the line route and wherever required, higher wind zone than that given in wind map shall be considered for tower design for ensuring reliability of line. Further, for transmission line sections passing within a distance of 50 km from the boundary of two wind zones, higher of the two wind zones shall be considered for design of towers located in such sections.
- A.5.0 Selection of reliability level for design of tower shall be as per CEA Regulation (Technical Standards for Construction of Electrical Plants and Electric Lines) Regulations 2022, as amended from time to time.
- A.6.0 A) For power line crossing of 400 kV or above voltage level, large angle & dead-end towers (i.e. D/DD/QD) shall be used on either side of power line crossing.
- B) For power line crossing of 132 kV and 220 kV (or 230 kV) voltage level, angle towers (B/C/D/DB/DC/DD/QB/QC/QD) shall be used on either side of power line crossing

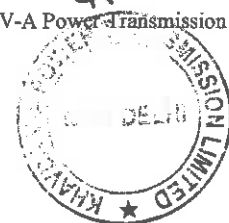
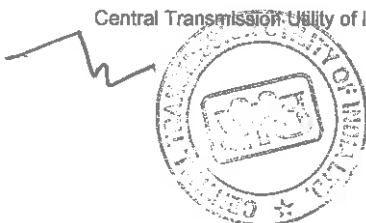

depending upon the merit of the prevailing site condition and line deviation requirement.

C) For power line crossing of 66 kV and below voltage level, suspension/tension towers shall be provided on either side of power line crossing depending upon the merit of the prevailing site condition and line deviation requirement.

D) For crossing of railways, national highways and state highways, Regulations of appropriate authorities shall be followed.

A.7.0 The relevant conductor configuration shall be as follows: -

Type of conductor: ACSR / AAAC / AL59

Basic parameters:

Transmission line	ACSR Conductor	Equivalent AAAC conductor based on 53% conductivity of Al Alloy	Equivalent AL59 conductor based on 59% conductivity of AL Alloy*	Sub-conductor Spacing
765 kV D/C (Hexa Bundle) transmission lines	Zebra: Stranding 54/3.18 mm-Al + 7/3.18 mm-Steel; 428 sq mm Aluminium area; 28.62 mm diameter; Maximum DC Resistance at 20°C (Ω/km): 0.06868; Minimum UTS: 130.32 kN	Stranding details: 61/3.19mm, 28.71 mm diameter; 487.5 sq.mm Aluminium alloy area; Maximum DC Resistance at 20°C (Ω/km): 0.06815; Minimum UTS: 135.6 kN	Stranding details: 61/3.08mm, 27.72 mm diameter; 454 sq.mm Aluminium alloy area; Maximum DC Resistance at 20°C (Ω/km): 0.0653; Minimum UTS: 108 kN	457 mm
400 kV D/C (Quad Bundle) transmission lines	Moose: Stranding 54/3.53mm-Al + 7/3.53 mm-Steel; 31.77 mm diameter;	Stranding details: 61/3.55mm 31.95mm diameter;	Stranding details: 61/3.31 mm 29.79 mm diameter;	457 mm

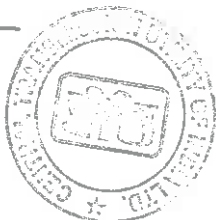

235

Transmission Service Agreement

Transmission line	ACSR Conductor	Equivalent AAAC conductor based on 53% conductivity of Al Alloy	Equivalent AL59 conductor based on 59% conductivity of AL Alloy*	Sub-conductor Spacing
	528.5 sq. mm, Aluminium area; Maximum DC Resistance at 20°C (Ω/km): 0.05552; Minimum UTS: 161.20 kN	604 sq. mm Aluminium alloy area; Maximum DC Resistance at 20°C (Ω/km): 0.05506; Minimum UTS: 159.80 kN	525 sq. mm Aluminium alloy area; Maximum DC Resistance at 20°C (Ω/km): 0.0566; Minimum UTS: 124.70 kN	

Note:

- *To select any size above the minimum, the sizes mentioned in the Indian standard i.e IS-398(part-6) should be followed.*
- The transmission lines shall have to be designed for a maximum operating conductor temperature of 85 deg C.*

A.8.0 The required phase to phase spacing and horizontal spacing for 765 kV and 400 kV line shall be governed by the tower design as well as minimum live metal clearances for 765 kV and 400 kV voltage level under different insulator swing angles. However, the phase to phase spacing for 765 kV and 400 kV lines shall not be less than 15 m and 8 m respectively.

A.9.0 All electrical clearances including minimum live metal clearance, ground clearance and minimum mid span separation between earth wire and conductor as given below shall be considered:

(a) Minimum live metal clearances for 765 kV line:

(i) Under stationary conditions:

From tower body: For 765 kV D/C: 6.1 m

For 765 kV S/C: 5.6 m



Central Transmission Utility of India Limited



181

Khavda V.A Power Transmission Limited

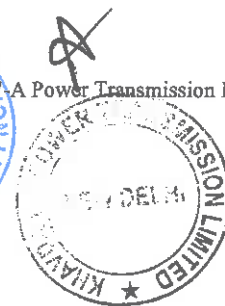

236

(ii) Under Swing conditions

Wind Pressure Condition	Minimum Electrical Clearance
a) Swing angle (25°)	4.4 m
b) Swing angle (55°)	1.3 m

(b) Minimum ground clearance for 765 kV line: 18 m

(c) Minimum mid span separation between earthwire and conductor for 765 kV line: 9.0 m

(d) Minimum live metal clearances for 400 kV line:

(i) Under stationary conditions:

From tower body: 3.05 m

(ii) Under Swing conditions

Wind Pressure Condition	Minimum Electrical Clearance
a) Swing angle (22°)	3.05 m
b) Swing angle (44°)	1.86 m

(e) Minimum ground clearance for 400 kV line: 8.84 m

(f) Minimum mid span separation between earthwire and conductor for 400 kV line: 9.0 m

A.10.0 Shielding angle shall not exceed 10 deg for 765 kV D/C and 20 deg for 400 kV transmission line.

A.11.0 The Fault current for design of line shall be 50 kA for 1 sec for 765 kV and 63 kA for 1 sec for 400 kV.

A.12.0 In case of 765 kV and 400 kV voltage class lines, at least one out of two earth wires shall be OPGW and second earth wire, if not OPGW, shall be either of galvanized standard steel (GSS) or Aluminum Alloy Conductor Steel Reinforced (AACSR) conductor type or any other suitable conductor type depending upon span length and other technical consideration.

A.13.0 Each tower shall be earthed such that tower footing impedance does not exceed 10 ohms. Pipe type or Counterpoise type earthing shall be provided in accordance with relevant IS. Additional earthing shall be provided on every 7 to 8 km distance at tension tower for direct earthing of both shield wires. If site condition demands, multiple earthing or use of earthing enhancement compound shall be used.

A14.0 Pile type foundation shall be used for towers located in river or creek bed or on bank of river having scourable strata or in areas where river flow or change in river course is anticipated, based on detailed soil investigation and previous years' maximum flood discharge of the river, maximum velocity of water, highest flood level, scour depth & anticipated change in course of river based on river morphology data of at least past 20 years to ensure availability and reliability of the transmission line.

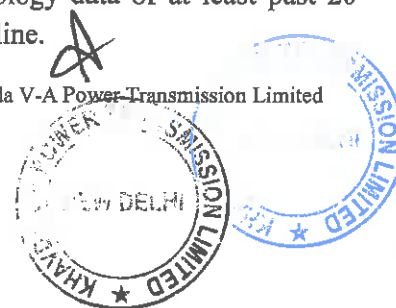
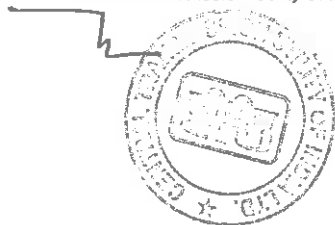

A.15.0 Transmission line route shall be finalized, in consultation with appropriate authorities so as to avoid the habitant zones of endangered species and other protected species. Bird diverters, wherever required, shall be provided on the line. In order to optimize the route use of GATISHAKTI platform shall also be made.

A. 16.0 Wherever, transmission lines are passing through cyclone prone areas i.e. areas up to 60 km from coast following shall also be applicable:

- a) Terrain category-I, with terrain roughness factor (K2) of 1.08 shall be considered for tower design for exposed open terrain with few or no obstruction which also includes open sea coasts, open stretch of water, desert and flat treeless plains
- b) Importance factor for cyclonic region (K4) of 1.3 shall be considered for tower design.
- c) The number of consecutive spans between the section points/ angle point shall not exceed 10 spans or 3 km instead of conventional practice of 15 spans or 5km, in order to reduce the failure of such towers in coastal areas due to cascading effect. The section shall be terminated with tension tower/ angle tower and angle of deviation should be based on the site requirement.

A.17.0 Wherever, transmission lines are passing through cyclone prone areas (i.e. areas up to 60 km from coast)/ creek regions/ aggressive soil areas following shall also be applicable:

- a) The fabricated tower parts and stubs shall have a minimum overall zinc coating of 900 gram/m² of surface area except for plates and sections below 5 mm thickness which shall have a minimum overall zinc coating of 610 gram/m² of surface area. The average zinc coating for all sections and plates 5 mm and above thickness shall be maintained as 127 microns and that for plates and sections below 5 mm thickness shall be maintained as 87 microns.
- b) Ready mix concrete of M30 Grade shall be used to avoid use of locally available saline water. However, design mix concrete of M30 Grade conforming to IS 456 with potable water can be used at locations where transportation of ready-mix concrete is not feasible. Minimum cement content in any case shall not be less than 330 kg/m³.
- c) The surface of the reinforced steel may be treated with epoxy-based coating to enhance corrosion performance of foundation. Use of epoxy coated reinforcement in foundation shall be as per IS 13620. In addition, two (2) coats of bituminous painting of minimum 1.6 kg/m² per coat shall be applied on all exposed faces of foundation (i.e. pedestal & base slab).
- d) Double coat of 20 mm thick cement plaster shall be provided on all exposed concrete surface up to 300 mm below ground level to give protection to concrete surface from environmental and saline effect.
- e) Before coping of chimney top portion, three coats of anti-corrosive paint of minimum 30-35 microns dry film thickness each shall be applied on the stub in the 50mm coping portion as well as up to 350 mm above CL portion.

Central Transmission Utility of India Limited



183

Khayda V-A Power Transmission Limited

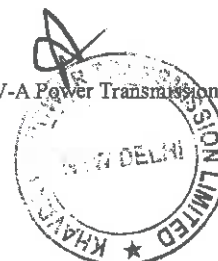

- A.18.0 The raised chimney foundation is to be provided in areas prone to flooding/water stagnation like paddy field /agricultural field & undulated areas to avoid direct contact of water with steel part of tower. The top of the chimney of foundation should be at least above HFL (High Flood Level) or the historical water stagnation/ logging level (based on locally available data) or above High Tide Level or 500 mm above Natural Ground level (whichever is higher).
- A.19.0 Routing of transmission line through protected areas of India shall be avoided to the extent possible. In case, it is not possible to avoid protected areas, the towers of the transmission line upto 400 kV level which are installed in protected areas shall be designed for Multi-circuit (4 circuits) configuration of same voltage level considering reliability level of at least two (2). The top two circuits of these multi-circuit towers shall be used for stringing of the transmission line under present scope and the bottom two circuits shall be made available for stringing of any future transmission line of any transmission service providers/ State transmission utilities/Central transmission utilities passing through the same protected area. Further, the configuration and coordinates of such transmission towers shall be submitted to CEA, CTU & BPC by the TSP.
- A.20.0 The TSP shall abide by the Guidelines of CEA w.r.t. shifting of transmission lines for NHAI projects and other projects.
- A 21.0 Safety precautions in regards to gas/oil pipe lines in vicinity of Transmission lines shall be taken in coordination with gas/ petroleum authorities.

Central Transmission Utility of India Limited

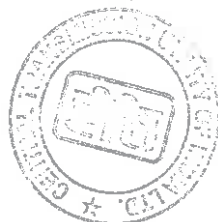

184

Khavda V-A Power Transmission Limited



SPECIFIC TECHNICAL REQUIREMENTS FOR HVAC EQUIPMENT

The proposed 765/400 kV Nagpur S/S shall be conventional AIS type and extension of Khavda PS-2 (KPS2) shall be Gas Insulated Switchgear (GIS) type generally conforming to the requirements of CEA (Technical Standards for Construction of Electrical Plants and Electric Lines) Regulations 2022 as amended from time to time.

Other CEA Regulations/guidelines as amended upto date and MoP guidelines, as applicable, shall also be followed.

B.1.0 Salient features of Substation Equipment and Facilities

The design and specification of substation equipment are to be governed by the following factors:

B.1.1 Insulation Coordination

The system design parameters for substations/switchyards shall be as given below:

Sl. No.	Description of parameters	765/400 kV Nagpur		400 kV KPS2
		765 kV System	400 kV System	400 kV System
1.	System operating voltage	765 kV	400 kV	400 kV
2.	Maximum voltage of the system (rms)	800 kV	420 kV	420 kV
3.	Rated frequency	50 Hz	50 Hz	50 Hz
4.	No. of phase	3	3	3
5.	Rated Insulation levels			
i)	Impulse withstand voltage for (1.2/50 micro sec.) - for Equipment other than Transformer and Reactors	2100 kV p	1425 kV p	1425 kV p



Transmission Service Agreement

Sl. No.	Description of parameters	765/400 kV Nagpur		400 kV KPS2
		765 kV System	400 kV System	400 kV System
	- for Insulator String	2100 kV p	1550 kV p	1550 kV p
ii)	Switching impulse withstand voltage (250/2500 micro sec.) dry and wet	1550 kV p	1050 kV p	1050 kV p
iii)	One-minute power frequency dry withstand voltage (rms)	830 kV	630 kV	650 kV
6.	Corona extinction voltage	508 kV	320 kV	320 kV
7.	Max. radio interference voltage for frequency between 0.5 MHz and 2 MHz	2500 microvolts at 508 kV rms	1000 microvolts at 266 kV rms	1000 microvolts at 266 kV rms
8.	Minimum creepage distance for insulator string/ longrod insulators/ outdoor bushings	24800 mm (31mm/ kV)	13020 mm (31mm/ kV)	13020 mm (31mm/ kV)
9.	Minimum creepage distance for switchyard equipment	20000 mm (25 mm/ kV)	10500 mm (25 mm/ kV)	13020 mm (31 mm/ kV)
10.	Max. fault current	50 kA	63 kA	63 kA
11.	Duration of fault	1 Sec	1 Sec	1 Sec

B.1.2 Switching Scheme

The switching schemes, as mentioned below, shall be adopted at various voltage levels of substation/switchyard:

Central Transmission Utility of India Limited



186

Khavda-A Power Transmission Limited

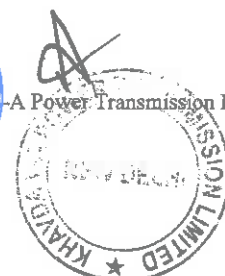

Transmission Service Agreement

Substation	765 kV side	400 kV side
765/400 kV Nagpur (AIS)	One & Half breaker	One & Half breaker
400 kV KPS2 (GIS)	-NA-	One & Half breaker

Notes: -

- i) For one and half breaker switching scheme, any double circuit line consisting of two numbers of feeders and originating from the same transmission or generating switchyard shall not be terminated in one diameter.
- ii) Two transformers of the same HV rating shall not be connected in the same diameter and similarly two bus reactors of same HV rating shall also not be connected in the same diameter.
- iii) 400kV Bus Sectionalisers shall be placed such that each section shall have even distribution of Poles, ICT, Feeders and filter bank(s)/sub-bank(s) so as to have maximum operational flexibility.
- iv) A diameter in one and half breaker scheme is a set of 3 circuit breakers with associated isolators, earth switches, current transformers etc. for controlling 2 numbers of feeders.
- v) In case of GIS substation where the bus scheme is One & Half breaker scheme, the diameters shall be complete with feeder/line side isolator and GIS duct of the future bay shall be brought outside the GIS hall/building with extension/interface module suitably.
- vi) Connection arrangement of Switchable Line reactors shall be such that it can be used as Line reactor as well as Bus reactor with suitable NGR bypass arrangement. Further, Spare 1-phase Shunt Reactor unit shall be placed and connected in such a way that the spare unit can be utilized for all the bus and switchable line reactor banks (including future reactor banks) without its physical movement.
- vii) Space provision for 765kV & 400kV Present as well as Future lines shall be kept considering switchable Line reactor for the lines.
- viii) Provision for Bus sectionalizer:

One (1) set of bus sectionalizer for 400kV shall comprise 2 nos. of bus sectionalizer bays with associated Circuit Breakers, Isolators and Current Transformers for both buses.

Space for One (1) set of future bus sectionalizer for 765kV shall comprise 2 nos. of bus sectionalizer bays with associated Circuit Breakers, Isolators and Current Transformers for both buses.

Central Transmission Utility of India Limited



187



Khayda V-A Power Transmission Limited

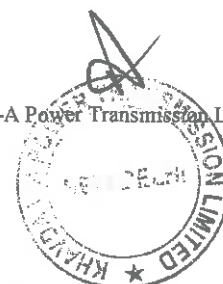

Transmission Service Agreement

Space for One (1) set of bus sectionalizer for 220 kV shall comprise 2 nos. of bus sectionalizer bays with associated Circuit Breakers, Isolators and Current Transformers for both buses.

- ix) TSP shall plan distribution of line and transformer feeders to bus bar in such a way that all power can be evacuated successfully without crossing thermal limit at any point of bus-bar.
- x) **Nagpur S/s:** Provision of 765kV Bus Sectionalization (Future) and space provision shall be with the following feeder distribution.

765kV Bus Section-1	765kV Bus Section-2 (Future)
a) 4 nos. of present 765kV Line b) 6 nos. of present 765/400kV ICT c) 2 nos. of present 765kV Bus Reactor d) 4 nos. of 765kV future lines	a) 6 nos. of future 765kV Line b) 4 nos. of future 765/400kV ICT c) 2 nos. of future 765kV Bus Reactor

Provision of 400kV Bus Sectionalization and space provision shall be with the following feeder distribution.

400kV Bus Section-1	400kV Bus Section-2	400kV Bus Section-3 (Future)
a) 2 nos. 1500 MW poles b) 3 nos. of present 765/400kV ICT c) 1 no. of present Bus Reactor d) 1 no. of future Bus Reactor	a) 2 nos. 1500 MW poles b) 3 nos. of present 765/400kV ICT c) 1 no. of present Bus Reactor d) 1 no of future 765/400kV ICT e) 3 nos. of future 400/220kV ICT f) 1 no. of future Bus Reactor g) 4 nos. of future 400kV Line	a) 3 nos. of future 765/400kV ICT b) 6 nos. of future 400/220kV ICT c) 2 nos. of future Bus Reactor d) 8 nos. of future 400kV Line

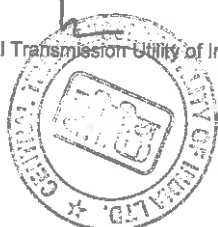

xi) **400 kV KPS-2 substation Section-I:** 2x1500 MW poles shall terminate into 400 kV bus section 1 of KPS2.

400 kV KPS-2 substation Section-II: 2x1500 MW poles shall terminate into 400 kV bus section II of KPS2.

B.2.0 Substation

Equipment and facilities (Voltage level as applicable):

The switchgear shall be designed and specified to withstand operating conditions and duty requirements. All equipment shall be designed considering the following minimum capacity.

Sl. No.	Description of bay	Ampacity		
		765/400 kV Nagpur		400 kV KPS2
		765 kV	400 kV	400 kV
1.	Bus Bar	4000 A	4000 A	4000 A
2.	Line bay	3150 A	3150 A	3150 A
3.	Converter bay	N/A	3150A	3150A
4.	ICT bay	3150 A	3150 A	NA
5.	Reactor bay	3150 A	3150 A	NA
6.	Bus Sectionaliser bays	NA	4000 A	NA

B.2.1 (765/√3)/(400/√3)/33 kV, Single Phase Autotransformer

500 MVA, (765/√3)/(400/√3)/33 kV , 1-phase Auto-Transformer (including arrangement for 3-phase bank formation of 1500 MVA) shall conform to CEA's "Standard Specifications and Technical Parameters for Transformers and Reactors (66 kV and above Voltage class)" available on CEA website.

Spare 1-phase Transformer unit shall be placed and connected in such a way that it can be utilized for any of the transformer banks (including for future transformer banks) without its physical movement.

Central Transmission Utility of India Limited

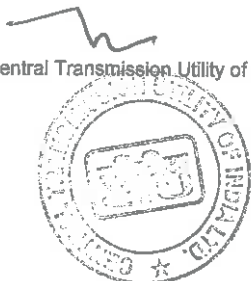

Khavda VVA Power Transmission Limited



244

B.2.2 (765/√3) kV, Single Phase Shunt Reactor

110 MVAR, 765/√3 kV, 1-Phase Reactor (including arrangement for 3-phase bank formation of 330 MVAR) & 80 MVAR, 765/√3 kV, 1-Phase Reactor (including arrangement for 3-phase bank formation of 240 MVAR) shall conform to CEA's "Standard Specifications and Technical Parameters for Transformers and Reactors (66 kV and above Voltage class)" available on CEA website.

Spare 1-phase Shunt Reactor unit shall be placed and connected in such a way that it can be utilized for all the bus and switchable line reactor banks (including for future reactor banks) without its physical movement.

Neutral Grounding Reactor and Surge Arrester for 765kV Line Reactors (as applicable):

The neutral of the line reactors (wherever provided) shall be grounded through adequately rated Neutral Grounding Reactors (NGR) to facilitate single phase auto-reclosure, provided that the NGR shall be provided with suitable bypass arrangement so that the line reactor can be used as Bus reactor as and when required. The neutral of bus reactor shall be solidly grounded.

NGR shall be oil filled or dry type air core for outdoor application. NGR shall conform to CEA's "Standard Specifications and Technical Parameters for Transformers and Reactors (66kV and above Voltage class)" as amended upto date. Technical parameters of NGR shall be as specified in Annexure-A of above-mentioned document.

The surge arresters (rated voltage of arrester in co-ordination with ohmic value of NGR shall be decided by the TSP) shall be provided & physically located between the neutral of shunt reactor (brought out at 145kV class bushing) and neutral grounding reactor. The surge arresters shall be of Station Medium (SM) class duty gapless Metal oxide (ZnO) type conforming in general to IEC-60099-4. Arresters shall be hermetically sealed units, of self-supporting construction, suitable for mounting on structures.

The Ohmic value of NGR for Line Reactors shall be as follows:

Sl. No.	Line Name	NGR value
1.	240 MVAR switchable line reactor at Nagpur end on each ckt of Nagpur – Raipur 765 kV D/c line	550 ohm

B.2.3 420kV, 3-Phase, Shunt Reactor

125MVAR, 420KV, 3-Phase Reactor shall conform to CEA's "Standard Specifications and Technical Parameters for Transformers and Reactors (66 kV and above Voltage class)" as amended up to date available on CEA website.

Central Transmission Utility of India Limited

190

Khavda V-A Power Transmission Limited



245

B.2.4 765 kV and 400 kV AIS Substation equipment (as applicable)

B.2.4.1 Circuit Breakers (AIS)

The circuit breakers and accessories shall conform to IEC: 62271-100, IEC: 62271-1 and shall be of SF6 Type. The circuit breakers shall be of class C2-M2 (as per IEC) with regard to restrike probability during capacitive current breaking and mechanical endurance. . Each breaker would have two sets of trip circuits which would be connected to separate DC supplies for greater reliability. The rated break time shall not exceed 40 ms for 765 kV & 400 kV circuit breakers. 765 kV & 400 kV Circuit breakers shall be provided with single phase and three phase auto reclosing. The Circuit breakers controlling 765 kV lines shall be provided either with pre-insertion closing resistor of about 450 ohms maximum with 9 ms insertion time or with Controlled Switching Device. The Circuit breakers controlling 400 kV lines shall be provided with pre-insertion closing resistor of about 400 ohms with 8 ms insertion time or Controlled Switching Device (CSD) for lines longer than 200 km. The short line fault capacity shall be same as the rated capacity, and this is proposed to be achieved without use of opening resistors. The controlled switching device shall be provided in Circuit breakers of switchable line reactor and in Main & Tie circuit breakers of line with non-switchable line reactors and Bus reactors and 765 kV class Transformers.

B.2.4.2 Isolators (AIS)

The isolators shall comply to IEC 62271-102 in general. 765 kV isolator design shall be double break or vertical break or knee-type. 400 kV isolator shall be double break type. All isolators and earth switches shall be motor operated. Earth switches shall be provided at various locations to facilitate maintenance. Isolator rated for 765 kV and 400 kV shall be of extended mechanical endurance class - M2 and suitable for bus transfer current switching duty as per IEC-62271-102. Main blades and earth blades shall be interlocked, and interlock shall be fail safe type. 765 kV and 400 kV earth switches for line isolator shall be suitable for induced current switching duty as defined for Class-B.

B.2.4.3 Current Transformers (AIS)

Current Transformers shall comply with IEC 61869 in general. All ratios shall be obtained by secondary taps only. Generally, Current Transformers (CT) for 765 kV & 400 kV shall have six cores (four for protection and two for metering). The burden and knee point voltage shall be in accordance with the requirements of the system including possible feeds for telemetry. Accuracy class for protection core shall be PX and for metering core it shall be 0.2S. The rated burden of cores shall be closer to the maximum burden requirement of metering & protection system (not more than 20 VA for metering core) for better sensitivity and accuracy. The instrument security factor shall be less than 5 for CTs upto 400 kV and less than 10 for CTs of 765 kV voltage class.

Central Transmission Utility of India Limited



Khavda V-A Power Transmission Limited

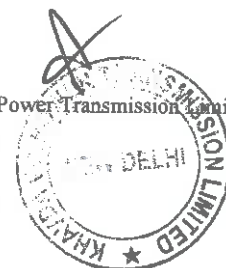

B.2.4.4 Capacitive Voltage Transformers (AIS)

Capacitive Voltage transformers shall comply with IEC 61869 in general. These shall have three secondaries out of which two shall be used for protection and one for metering. Accuracy class for protection cores shall be 3P and for metering core shall be 0.2. The Capacitive voltage transformers on lines shall be suitable for Carrier Coupling. The Capacitance of CVT for 400 kV shall be of 4400/8800 pF depending on PLCC requirements however the Capacitance of CVT for 765 kV shall be 8800 pF. The rated burden of cores shall be closer to the maximum burden requirement of metering & protection system (not more than 50 VA for metering core) for better sensitivity and accuracy.

B.2.4.5 Surge Arresters (AIS)

624 kV & 336 kV Station High (SH) duty gapless type Surge arresters with thermal energy (Wth) of minimum 13 kJ/ kV and 12 kJ/ kV conforming to IEC 60099-4 in general shall be provided for 765 kV and 400 kV systems respectively. Other characteristics of Surge arrester shall be chosen in accordance with system requirements. Surge arresters shall be provided near line entrances, Transformers and Reactors so as to achieve proper insulation coordination. Surge Arresters shall be provided with porcelain/ polymer housing fitted with pressure relief devices. A leakage current monitor with surge counter shall be provided with each surge arrester.

B.2.5 400kV GIS Substation equipment (as applicable)

GIS (Gas Insulated Switchgear) shall be Indoor type in accordance to IEC: 62271-203. The switchgear shall be designed and specified to withstand operating conditions and duty requirements. All the switchgear such as Circuit Breaker, isolator, earth switch including CT, PT etc. shall be GIS type. The Surge Arrester and Voltage Transformer shall be either GIS or outdoor AIS type.

The GIS assembly shall consist of separate modular compartments e.g. Circuit Breaker compartment, Bus bar compartment filled with SF₆ Gas and separated by gas tight partitions so as to minimize risk to human life, allow ease of maintenance and limit the effects of gas leaks failures & internal arcs etc. These compartments shall be designed to minimize the risk of damage to adjacent sections and protection of personnel in the event of a failure occurring within the compartments. Rupture diaphragms with suitable deflectors shall be provided to prevent uncontrolled bursting pressures developing within the enclosures under worst operating conditions, thus providing controlled pressure relief in the affected compartment. The arrangement of gas sections or compartments shall be such as to facilitate future extension of any make without any drilling, cutting or welding on the existing equipment. To add equipment, it shall not be necessary to move or dislocate the existing switchgear bays. The layout of Gas Insulated Bus Ducts shall be properly planned to optimize the length of bus ducts and for easy accessibility for maintenance. The length

Central Transmission Utility of India Limited

192

Khavda V-A Power Transmission Limited

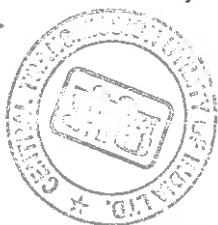

247

of busbars, bus ducts, isolator sections shall be optimized considering effects of fast transient voltage due to isolator operations.

The bus bar modules including auxiliary bus modules (wherever applicable) shall be provided with suitable End Piece (Interface) module on both sides with the test link facility for future extension as per provisions of future requirement. The end piece module shall be designed in such a way so that future GIS module may be tested without extending test voltage to existing bus and vice-versa by removing the test link.

TSP shall make available the complete details for the design of interface module such as cross section, enclosure material, enclosure dimensions (inner and outer), Flange diameter (inner and outer), conductor cross-section and connection arrangement, bolt spacing and dimension, rated gas pressure, Gasket detail etc. Further, adequate space for GIS busbar interface module shall be taken into account for future scope.

Each section shall have plug-in or easily removable connection pieces to allow for easy replacement of any component with the minimum disturbance to the remainder of the equipment. Inspection windows (View Ports) shall be provided for Disconnect Switches and both type of earth switches i.e. Maintenance and fast operating.

Local control cabinets (LCC) shall be provided as per requirement. The alarm and annunciation of GIS equipment shall be wired to the SCADA System.

The material and thickness of the enclosures shall be such as to withstand an internal flash over without burns through for a period of 300 ms at rated short time withstand current. The material shall be such that it has no effect of environment as well as from the by-products of SF₆ breakdown under arcing conditions. This shall be validated with Type Test.

Service continuity requirement for GIS:

The GIS equipment with the given bus switching arrangement shall be divided into different gas compartments. During the work such as a fault repair or major maintenance, requiring the dismantling of a gas compartment for which more than one compartments may need to be de-gassed.

TSP shall meet the following Service continuity conditions (to the extent possible) with ensuring equipment and operating personnel's safety:

- For One and half breaker bus switching scheme, during a fault in Circuit Breaker compartment, no bus bar and feeder is permitted out of service during maintenance and repair/replacement.
- During a fault in a GIS compartment other than the Circuit Breaker compartment, maximum of one bus bar and/or one feeder is permitted out of service during maintenance and repair/replacement.

UHF sensors in GIS for PD (Partial Discharge) detection:

Central Transmission Utility of India Limited

193

Khavda VVA Power Transmission Limited

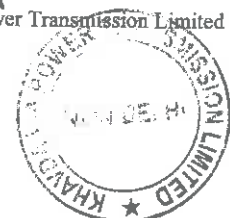
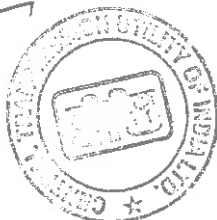

248

The adequate number of Ultra High frequency (UHF) sensors shall be provided in the offered GIS alongwith suitable portable type Partial discharge (PD) measuring instrument for detection of Partial discharge (of 5 pC and above as per IEC 60270). The number and location of these sensors shall be based on laboratory tests on the typical design of GIS as per recommendations of CIGRE Document No. 654 (Application Guide for sensitivity verification for UHF Partial discharge detection system for GIS).

B.2.5.1 Circuit Breakers (GIS)

GIS Circuit breakers shall in general be of C2-M2 class and comply with IEC-62271-100. The rated break time shall not exceed 40 ms (milli second) for 400kV. Circuit breakers shall be suitable for single phase and three phase auto reclosing. Each breaker shall have two sets of trip circuits which would be connected to separate DC supplies for greater reliability. The Circuit breakers controlling 400kV lines wherever required shall be provided with pre-insertion closing resistor of about 400 ohms with 8 ms insertion time or Controlled Switching Device (CSD) for lines longer than 200 km. The short line fault capacity shall be same as the rated capacity and this is proposed to be achieved without use of opening resistors. Controlled switching device shall be provided in Circuit Breaker of switchable line reactor bay and in 400kV & above Main & Tie bay circuit breakers of line with non-switchable line reactors, Bus reactors and Transformers.

B.2.5.2 Isolators (GIS)

The isolators shall comply to IEC 62271-102 in general. Earth switches shall be provided at various locations to facilitate maintenance. Main blades and earth blades shall be interlocked and interlock shall be fail safe type. All isolators and earth switches shall be motor operated type.

Isolator shall be of extended mechanical endurance class-M2 and suitable for Bus Transfer Current Switching duty as per IEC standard. High speed earthing switches shall be provided for grounding purpose at overhead line terminations & cable terminations and shall have fault making capability as specified. Earth switch for line isolator shall be of earthing switch class E1 and shall be suitable for induced current switching duty as defined for Class-B as per relevant standard.

B.2.5.3 Current Transformers (GIS)

Current Transformers shall comply with IEC 61869 in general. All ratios shall be obtained by secondary taps only. Generally, Current Transformers (CT) shall have five cores (four for protection and one for metering) whereas; CT in Tie bays shall have six cores (four for protections and two for metering) suitably distributed on both sides of CB (for 400kV and above voltage class). The burden and knee point voltage shall be in accordance with the requirements of the system including possible feeds for telemetry. Accuracy class for protection core shall be PX and for the metering core it shall be 0.2S. The rated burden of

Central Transmission Utility of India Limited

194

Khavda V-A Power Transmission Limited

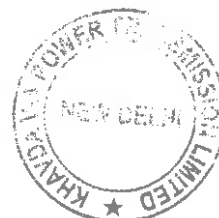

249

cores shall be closer to the maximum burden requirement of metering and protection system (not more than 20VA for metering core) for better sensitivity and accuracy.

The instrument security factor shall be less than 5 for CTs upto 400 kV voltage class.

B.2.5.4 Voltage Transformer (GIS)

The voltage transformers shall conform to IEC-61869. Voltage transformers shall be of electromagnetic type with SF₆ gas insulation. The earth end of the high voltage winding and the ends of the secondary winding shall be brought out in the terminal box. The voltage transformers shall be located as a separate bay module and will be connected phase to ground and shall be used for protection, metering and synchronization. The voltage transformers shall be of inductive type, nonresistant and shall be contained in their own-SF₆ compartment, separated from other parts of installation. The voltage transformer shall be effectively shielded against high frequency electromagnetic transients. The voltage transformer shall have three secondary windings out of which two shall be used for protection and one for metering. The voltage transformer should be thermally and dielectrically safe when the secondary terminals are loaded with the guaranteed thermal burdens. The accuracy class for protection cores shall be 3P. The accuracy of 0.2 on metering core should be maintained throughout the entire burden range on all the three windings without any adjustments during operation. The rated burden of cores shall be closer to the maximum burden requirement of metering and protection system (not more than 50VA for metering core) for better sensitivity and accuracy.

B.2.5.5 Surge Arresters (GIS) (if applicable)

336 kV Station High (SH) duty gapless type Surge arresters with thermal energy (Wth) of minimum 12 kJ/kV respectively shall be provided for 420kV system conforming to IEC 60099-4 in general. Other characteristics of Surge arrester shall be chosen in accordance with system requirements. Surge arresters shall be provided at line entrances, near Transformers and Reactors so as to achieve proper insulation coordination. A leakage current monitor with surge counter shall be provided with each surge arrester.

B.2.5.6 SF₆ to Air Bushing

Outdoor bushings, for the connection of conventional external conductors to the SF₆ metal enclosed switchgear, shall be provided. Bushings shall generally be in accordance with the requirements of IEC-60137. The creepage distance over the external surface of outdoor bushings shall not be less than 31 mm/kV. SF₆ to air Bushing shall be of Polymer / composite type and shall be robust and designed for adequate cantilever strength to meet the requirement of seismic condition. The electrical and mechanical characteristics of bushings shall be in accordance with IEC-60137. Polymer/composite insulator shall be seamless sheath of silicon rubber compound. The housing and weather sheds should have silicon content of minimum 30% by weight. It should protect the bushing against

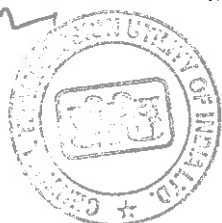

environmental influences, external pollution and humidity. The hollow silicon composite insulators shall comply with the requirements of IEC 61462 and the relevant parts of IEC-62217.

B.2.6 Protection Relaying and Control System

The protective relaying system proposed to be provided for transmission lines, auto-transformers, reactors and bus bars to minimize the damage to the equipment in the events of faults and abnormal conditions, is dealt in this section. All main protective relays shall be numerical type with IEC 61850 communication interface and should have interoperability during integration of numerical relays to communicate over IEC 61850 protocol with RTU/SAS/IEDs of different OEMs All numerical relays shall have built in disturbance recording feature.

The protection circuits and relays of transformer and reactor shall be electrically and physically segregated into two groups each being independent and capable of providing uninterrupted protection even in the event of one of the protection groups failing, to obtain redundancy, and to take protection systems out for maintenance while the equipment remains in service.

a) Transmission Lines Protection

765 kV and 400 kV transmission lines shall have Main-I numerical three zone distance protection scheme with carrier aided inter-tripping feature. 765 kV & 400 kV lines shall also have Main-II numerical distance protection scheme like Main-I but from different make that of Main-I. The Main-I and Main-II protection relays of same make may be provided only if they are of different hardware & manufacturing platform or different principle of operation.

However, Line Current Differential relay (with back up distance protection feature) as Main-I and Main-II shall be considered at both ends for short lines (line length below 30 km) having Fiber Optic communication link. Differential relay at remote end shall be provided by the TSP. Associated power & control cabling and integration with SAS at remote end shall be provided by respective bay owner.

In case of loop in loop out of transmission lines, the existing protection scheme shall be studied and suitable up-gradation (if required) shall be carried out.

Further, all 765 kV & 400 kV lines shall be provided with single and three phase auto-reclosing facility to allow reclosing of circuit breakers in case of transient faults. These lines shall also be provided with distance to fault locators to identify the location of fault on transmission lines.

All 765 kV and 400 kV lines shall also be provided with two stages over voltage protection. Over voltage protection and distance to fault locator may be provided as in-built

Central Transmission Utility of India Limited

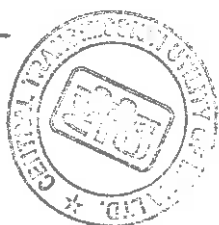

196

Khavda V-A Power Transmission Limited

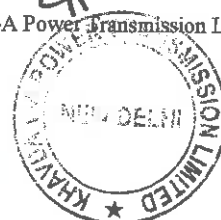

251

feature of Main-I and Main-II protection relays. Auto reclose as built-in function of Bay Control Unit (BCU) is also acceptable.

The Main-I and Main-II protection relays shall be fed from separate DC sources and shall be mounted in separate panels.

For 765 kV and 400 kV transmission lines, directional IDMT earth fault relay should be provided as standalone unit or in-built feature of Main-I and Main -II feature.

b) Auto Transformer Protection

These shall have the following protections:

- i) Numerical Differential protection
- ii) Numerical Restricted earth fault protection
- iii) Numerical Back-up Over-current and earth fault protection on High Voltage (HV) & Intermediate Voltage (IV) side
- iv) Numerical Over fluxing protection on HV & IV side
- v) Numerical Overload alarm

Further, Numerical Back-up Over-current and earth fault protection on HV and IV side of autotransformer shall not be combined with other protective functions in the main relays and shall be independent relays. Besides these, power transformers shall also be provided with Buchholz relay, Magnetic Oil Gauge (MOG) with low oil level alarm, protection against high oil and winding temperature and pressure relief device etc.

Suitable monitoring, control (operation of associated circuit breaker and isolator) and protection for LT auxiliary transformer connected to tertiary winding of auto-transformer for the purpose of auxiliary supply shall be provided. The Over current and other necessary protection shall be provided for the auxiliary transformer. These protection and control may be provided as built in feature either in the bay controller to be provided for the auxiliary system or in the control and protection IEDs to be provided for autotransformer.

c) 765 kV and 400 kV Reactor Protection

Reactor shall be provided with the following protections:

- i) Numerical Differential protection.
- ii) Numerical Restricted earth fault protection
- iii) Numerical Back-up impedance protection

Besides these, reactors shall also be provided with Buchholz relay, Magnetic Oil Gauge (MOG) with low oil level alarm, protection against oil and winding temperatures and pressure relief device, etc.

 Central Transmission Utility of India Limited

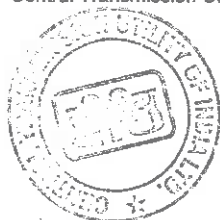

197

Khavda V-A Power Transmission Limited

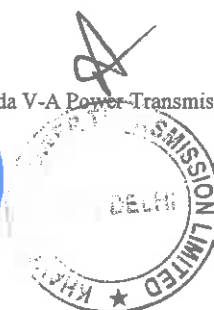

252

d) Bus Bar Protection

The high-speed low impedance type bus bar differential protection, which is essential to minimize the damage and maintain system stability at the time of bus bar faults, shall be provided for 765 kV and 400 kV buses. Duplicated bus bar protection is envisaged for 765 kV and 400 kV bus-bar protection. Bus bar protection scheme shall be such that it operates selectively for each bus and incorporate necessary features required for ensuring security. The scheme shall have complete bus bar protection for present as well as future bays envisaged i.e. input / output modules for future bays shall also be provided.

Bus Bar protection system for new substation shall be de-centralized (distributed) type.

In case, the bus section is provided, then each side of bus section shall have separate set of bus bar protection schemes.

For existing substations, the existing bus bar protection shall be augmented as per requirement.

e) Local Breaker Back up Protection

This shall be provided for each 765 kV and 400 kV circuit breakers and will be connected to de-energize the affected stuck breaker from both sides.

Notes:

1. *LBB and REF relays shall be provided separately from transformer differential relay.*
2. *LBB relay may also be provided as built-in protection function of distributed bus bar protection scheme; however, in such case separate LBB relay shall be provided for tie bays (in case of One and Half breaker scheme).*
3. *Over fluxing and overload protection can be provided as built-in feature of differential relay.*
4. *In 765 kV and 400 kV switchyard, if spare bay of half diameter is identified as future, Tie CB relay panel shall be with Auto-reclosure feature.*

B.2.6 Substation Automation System

- a) For all the new substations, state of art Substation Automation System (SAS) conforming to IEC-61850 shall be provided. The distributed architecture shall be used for Substation Automation system, where the controls shall be provided through Bay control units. The Bay control unit is to be provided bay wise for voltage level 400 kV and above. All bay control units as well as protection units are normally connected through an Optical fiber high speed network. The control and monitoring of circuit breaker, dis-connector, re-setting of relays etc. can be done from Human Machine Interface (HMI) from the control room.



Central Transmission Utility of India Limited



198



253

A

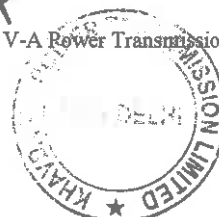

Khavda V-A Power Transmission Limited

The functions of control, annunciation, disturbance recording, event logging and measurement of electrical parameters shall be integrated in Substation Automation System.

At new substations, the Substation Automation System (SAS) shall be suitable for operation and monitoring of the complete substation including proposed future bays/elements.

In existing substations with Substation Automation System (SAS), augmentation of existing SAS shall be done for bays under present scope.

In existing Substations where Substation automation is not provided, control functions shall be done through control panels.

Necessary gateway & modems (as required) shall be provided to send data to RLDC/SLDC as per their requirement and shall be provisioned with 2+2 redundancy i.e. 2 channels for Main Control Centre and 2 channels for Backup Control Centre. In order to meet this requirement, suitable redundancy at port and card level need to be ensured by the TSP to avoid any single point of failure which may lead to interruption in real-time grid operation. Accordingly, all the hardware for communication services of station as stated above shall support dual redundancy for data transmission of station to respective main and backup RLDCs. Any augmentation work at RLDC/SLDC is excluded from TSP's scope. However, all the configuration work at substation end required to send data to RLDC/SLDC shall be in the scope of TSP.

b) Time synchronization equipment

Time synchronization equipment complete in all respect including antenna, cable, processing equipment required to receive time signal through GPS or from National Physical Laboratory (NPL) through INSAT shall be provided at new substations. This equipment shall be used to synchronize SAS and IEDs etc.

B.3.0 Substation Support facilities

Certain facilities required for operation and maintenance of substations as described below shall be provided at new substation. In existing substation, these facilities have already been provided and would be extended/ augmented as per requirement.

B.3.1 Fire Fighting System

Fire-fighting system for substation including Transformer & Reactor shall conform to CEA (Measures Relating to Safety & Electric Supply) Regulations, 2023 as amended time to time.

Further, adequate water hydrants and portable fire extinguishers shall be provided in the substations. The main header of firefighting system shall be suitable for extension to bays covered under the future scope; necessary piping interface in this regard shall be provided.

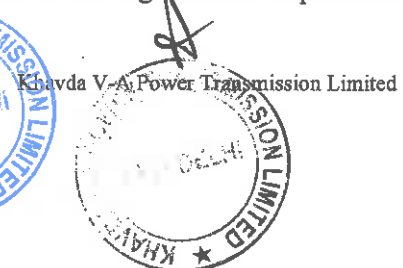
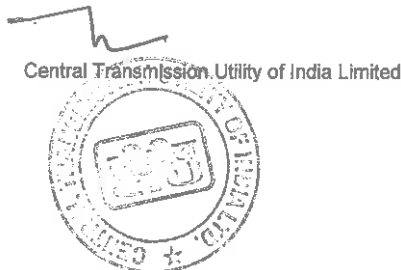

Optical Beam type heat detection for GIS hall fire protection system shall be provided for all the GIS halls.

At existing substations, the fire-fighting systems as available shall be extended to meet the additional requirements.

B.3.2 Oil evacuating, filtering, testing & filling apparatus

To monitor the quality of oil for satisfactory performance of transformers, shunt reactors and for periodical maintenance necessary oil evacuating, filtering, testing and filling apparatus would be provided at new substations. Oil storage tanks of adequate capacities for storage of transformer oil would be provided.

Online Transformer Oil Drying Out System shall be provided in line with the provisions of Standard Specification and Technical Parameters for Transformers and Reactors (66 kV & above Voltage Class) as amended up to date available on CEA website.

B.3.3 Illumination

Normal & emergency AC & DC illumination shall be provided adequately in the control room and other buildings of the substation. The switchyard shall also be provided with adequate illumination.

Lighting of the entire control room building, fire-fighting pump house, other building (if any) and switchyard shall be done by LED based low power consumption luminaires.

B.3.4 Control Room

For new substation, substation control room shall be provided to house substation workstations for station level control (SAS) along with its peripheral and recording equipment, AC & DC distribution boards, DC batteries & associated battery chargers, Fire Protection panels, Telecommunication panels and other panels as per requirements. Air conditioning shall be provided in the building as functional requirements. Main cable trenches from the control room shall have adequate space provision for laying of cables from control room for all the future bays also.

Common control room may be constructed for HVDC and HVAC systems.

At existing substations, the adequacy of size of control room shall be ascertained and the same shall be augmented as per requirement.

Central Transmission Utility of India Limited

200  Khavda V-A Power Transmission Limited

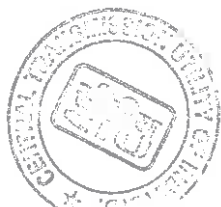

255

B.3.5 GIS hall

The Gas Insulated Switchgear (GIS) of each voltage level along with other associated equipment shall be housed inside **separate** GIS building. The panels i.e. Bay level units, bay mimic, relay and protection panels, RTCC panels, PLCC panels, panels for telecommunication system etc. are to be placed in a separate room in the GIS building. The size of the room shall be such that all the panels for the bays under present scope shall be accommodated. The panel room shall be air-conditioned. Further, the temperature of the room shall be monitored through substation automation system by providing necessary temperature transducers. Ventilation system of suitable capacity shall be provided for each GIS hall.

One EOT Crane of suitable capacity for erection & Maintenance of largest GIS component/assembly and all plant installed in the GIS switchgear room shall be provided in each GIS hall. The crane shall be capable of fulfilling all special requirements for erection and maintenance of GIS equipment. The capacity of the crane shall be sized to lift the heaviest GIS switchgear component.

For extension of existing GIS, existing facilities shall be suitably augmented/ extended for GIS equipment under present scope.

B.3.6 Control Concept

All the EHV circuit breakers in substation/switching stations shall be controlled and synchronized from the switchyard control room/remote control center. All the isolators shall have control from remote/local whereas the earth switches shall have local control only.

B.4 General Facilities

- a) Line Gantry/Towers are envisaged for bays under present scope only. However, for adjacent future line bay, tower shall be designed for extension (considering Quad conductors for 765kV and 400kV future lines) wherever applicable.
- b) Bay extension works at existing substation shall be executed by TSP in accordance with the requirement/provisions mentioned above. However, interface points shall be considered keeping in view the existing design/arrangement at the substation.
- c) TSP has to arrange for construction power and water on its own.
- d) All outdoor steel structures including anchor/foundation bolts shall be fully galvanized. The weight of the zinc coating shall be at least 610 gm/sq.m and 900 gm/sq.m for coastal/creek regions (if applicable).
- e) In 765 kV and 400 kV switchyard, if spare bay of half diameter is identified as future, all the equipment for Tie & Future bays shall be designed considering the current rating of line bay i.e. 3150 A.

Central Transmission Utility of India Limited



201



Khavda VVA Power Transmission Limited



256

- f) Boundary wall shall be brick masonry wall with RCC frame or Stone masonry wall or Precast RCC wall under present scope along the property line of complete substation area including future switchyard area to prevent encroachment and unauthorized access. Minimum height of the boundary wall shall be of 1.8 m from finished ground level (FGL).
- g) All electrical equipment shall be installed above the Highest Flood Level and where such equipment is not possible to be installed above the Highest Flood Level, it shall be ensured that there is no seepage, leakage or logging of water.

B.5 EXTENSION OF EXISTING SUBSTATION

The following drawings/details of existing substation is attached with the RFP documents for further engineering by the bidder.

Sl. No.	Drawing Title	Drawing No./Details	Rev. No.
A.	400 kV KPS2 Extension		
1.0	Single Line Diagram	CC_ENGG_SLD_KPS-2	R0
2.0	General Arrangement	KEC-SA323-KPS2-ESE-305-100	R3
3.0	Earthmat Layout	KEC-SA323-KPS-II-ESE-307-DRG-045	R2
4.0	Visual Monitoring System		
5.0	Bus Bar Protection	Make: Siemens make (765 kV & 400 kV) Models: 7SS8 (CU) & 6MU8 (Bay units)	
6.0	Substation Automation System (SAS)	Make: Siemens	

Bidder is also advised to visit the substation sites and acquaint themselves with the topography, infrastructure such as requirement of roads, cable trench, drainage etc. and also the design philosophy.

Central Transmission Utility of India Limited

Khavda V-A Power Transmission Limited



A



SPECIFIC TECHNICAL REQUIREMENTS FOR COMMUNICATION

The communication requirement shall be in accordance to CEA (Technical Standards for Communication System in Power System Operations) Regulations, 2020, CEA (Technical Standards for Construction of Electrical Plants and Electric Lines) Regulations, 2022, CERC (Communication System for inter-State transmission of electricity) Regulations, 2017, and CEA (Cyber Security in Power Sector) Guidelines, 2021, all above documents as amended from time to time.

The complete ISTS communication system commissioned by TSP under the RFP shall be the asset of ISTS and shall be available for usage of ISTS requirements as suggested by CTU from time to time.

The communication services viz. SCADA, VoIP, PMU, AGC & AMR (wherever applicable) have been identified as critical services and therefore shall be provisioned with 2+2 redundancy i.e. 2 channels for Main Control Centre and 2 channels for Backup Control Centre. In order to meet this requirement, suitable redundancy at port and card level need to be ensured by the TSP to avoid any single point of failure which may lead to interruption in real-time grid operation.

PMU to PDC communication (wherever required) shall be through 2 channels to the PDC (main) as there is no backup PDC at present.

Accordingly, all the hardware for communication services of station as stated above shall support dual redundancy for data transmission of station to respective main and backup RLDCs.

In order to meet the requirement for grid management and operation of substations, Transmission Service Provider (TSP) shall provide the following:

For smooth operation of the HVDC system, communication network with high reliability and availability shall be provided for transmission of control and protection signals between the two or more (in case of multi-terminal DC) HVDC terminals. The communication system design shall be as follows:

- Main-I
- Main-II (as hot standby to Main-I)
- Back-up communication

The TSP shall supply, install and commission SDH equipment required for the converter stations at **KPS2** and **Nagpur** and the necessary repeater stations. The repeater stations for fibre optic communication are also included in the scope of the TSP. The number and locations of repeaters shall be finalized after survey by TSP.



COMMUNICATION SYSTEMS GENERAL

Duplicated (2X100%) main communication systems (Main-I and Main-II) at KPS2 and Nagpur terminal and its repeaters shall comprise first cubicle of Main Fibre Optic Terminal equipment (FOTE) and second cubicle of Standby FOTE to be provided to meet the requirements of the control, protection, data transfer and telephone systems. System shall be based on the fibre optic communication between the converter stations through ± 800 KV DC lines. Each Main and Standby FOTE system shall be independent of each other. TSP to design the optical fibre Communication system between the converter stations in such a way that communication is available even when there is complete failure of one FOTE system. All repeater stations required for the communication system shall be provided by TSP. The TSP shall provide all required equipment, accessories, routers, modems and facilities etc., as required, for successful commissioning and use of the communication channels at KPS2 and Nagpur HVDC Bipole terminal.

The backup communication link shall also be provided through OPGW on parallel AC Lines. Necessary support shall be provided by the TSP to other TSP/s whose existing communication network is required to be configured for backup communication. Configuration work shall be done by the backup communication system owner/s for the KPS2 - Nagpur HVDC link in coordination with the TSP. TSP shall be responsible for all interface requirements with the Communication system of the other TSP(s) whose OPGW/Communication equipment are required for successful commissioning of the backup communication link including hardware/accessories etc.

1. Establishment of 6000 MW, ± 800 kV KPS2 (HVDC) [LCC] terminal station (4x1500 MW) along with associated interconnections with 400 kV HVAC Switchyard.

- (i) TSP shall supply, install & commission one or more no. FODP (144 F or higher) alongwith panel and approach Cable (24F each) with all associated hardware fittings from gantry tower to Control Room for all the incoming lines envisaged under the present scope.
- (ii) TSP shall supply, install and commission 2 nos. of STM-16 (FOTE) equipment locally patched (in redundant mode connected with separate fibre pairs of same OPGW) alongwith panel/s supporting minimum Three (3) directions with MSP (Multiplex Section Protection – 1+1, excluding local patching) at KPS2 (HVDC) S/s with necessary interfaces to meet the voice and data communication requirement among KPS2 HVDC, KPS2 GIS, Nagpur (HVDC)/ Repeater Stations. The suitable DC Power Supply and backup to be provided for each communication equipment operational in redundant mode.
- (iii) FODP and FOTE equipment with panels shall be provided in Control Room of KPS2 (HVDC) S/s. FOTE and FODP equipment can be accommodated in same

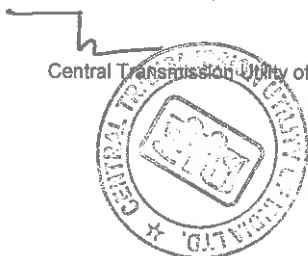

panel to optimize space.

- (iv) The FOTE under present scope at HVDC shall be integrated by TSP with the existing FOTE at control room of KPS2 GIS. TSP to provide necessary FODP sub rack / Splice trays/ Patch cords etc. and optical interfaces/ equipment in the existing FOTE/FODP panels in control room for providing required optical directions with the existing FOTE for onwards data transmission.
- (v) The new communication equipment under the present scope shall be compatible for integration with existing regional level centralized NMS. The local configuration of the new communication equipment shall be the responsibility of TSP. The configuration work in the existing centralized NMS for integration of new Communication equipment shall be done by Regional ULDC Team, however all the necessary support in this regard shall be ensured by TSP.
- (vi) TSP shall supply, install & commission Firewall in redundant mode (1+1) in line with the specification attached at Annexure F.1.
- (vii) The maintenance of all the communication equipment and software thereof including FOTE, FODP, approach cable, Repeater Station, PMU, DCPS alongwith Battery Bank & Firewall shall be the responsibility of TSP.

2. Establishment of 6000 MW, \pm 800 kV Nagpur (HVDC) [LCC] terminal station (4x1500 MW) along with associated interconnections with 400 kV HVAC Switchyard.

- (i) TSP shall supply, install & commission one or more no. FODP (240 F or more) alongwith panel and approach Cable (24F each) with all associated hardware fittings from gantry tower to Control Room for all the incoming lines envisaged under the present scope.
- (ii) TSP shall supply, install and commission 2 nos of STM-16 (FOTE) equipment locally patched (in redundant mode connected with separate fibre pairs of same OPGW) alongwith panel/s supporting minimum Five (5) directions with MSP (Multiplex Section Protection – 1+1, excluding local patching) at Nagpur (HVDC) S/s with necessary interfaces to meet the voice and data communication requirement among Nagpur HVDC, Nagpur S/s, KPS2 (HVDC), Wardha, Raipur & Repeater Stations. TSP to also provide suitable optical interfaces/equipment at Wardha & Raipur Substations FOTE to meet link budget requirement for connectivity with Nagpur (HVDC) Station. The suitable DC Power Supply and backup to be provided for each communication equipment operational in redundant mode.

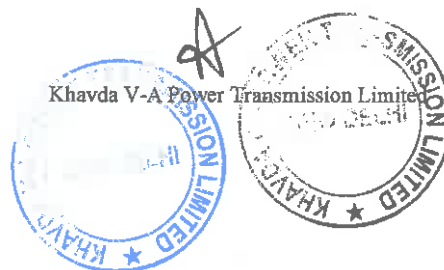

- (iii) FODP & FOTE equipment with panels shall be provided in Control Room of Nagpur (HVDC) S/s. FOTE and FODP equipment can be accommodated in same panel to optimize space.
- (iv) The FOTE under present scope at HVDC shall be integrated by TSP with the existing FOTE at control room of Nagpur AC S/s. TSP to provide necessary FODP sub rack / Splice trays/ Patch cords etc. and optical interfaces/ equipment in the existing FOTE/FODP panels in control room for providing required optical directions with the existing FOTE for onwards data transmission.
- (v) The new communication equipment under the present scope shall be compatible for integration with existing regional level centralized NMS. The local configuration of the new communication equipment shall be the responsibility of TSP. The configuration work in the existing centralized NMS for integration of new Communication equipment shall be done by Regional ULDC Team, however all the necessary support in this regard shall be ensured by TSP.
- (vi) TSP shall supply, install & commission Firewall in redundant mode (1+1) in line with the specification attached at Annexure F.1.
- (vii) The maintenance of all the communication equipment and software thereof including FOTE, FODP, approach cable, Repeater Station, PMU, DCPS alongwith Battery Bank & Firewall shall be the responsibility of TSP.

3. ± 800 kV HVDC Bipole line (Hexa lapwing) between KPS2 (HVDC) and Nagpur (HVDC) (1200 km) (with Dedicated Metallic Return) (capable to evacuate 6000 MW with overload as specified)

On KPS2 (HVDC) – Nagpur (HVDC) ± 800 KV HVDC line, TSP shall supply, install and commission One (1) no. OPGW cable containing 24 Fibres (24F) on one E/W peak and conventional earth wire on other E/W peak. OPGW diameter shall be inline with earthwire parameters mentioned in Annexure-E1 (Specific technical requirements for HVDC transmission line).

The TSP shall install this OPGW from gantry of KPS2 (HVDC) up to the gantry of Nagpur (HVDC) S/s with all associated hardware including Vibration Dampers, mid-way & gantry Joint Boxes (called OPGW Hardware hereafter) and finally terminate in Joint Boxes at end Substations. The transmission line length is 1200 kms (approx.) where repeaters are required to meet link budget requirement of KPS2 (HVDC) – Nagpur (HVDC).

TSP shall finalize the location and number of repeater stations depending upon the actual site conditions. Further TSP shall comply to the requirements mentioned as per



Appendix-F.1.

4. LILO of Wardha – Raipur 765 kV one D/c line (out of 2xD/c lines) at Nagpur.

On LILO of both circuits of one Wardha – Raipur 765kV D/c line (out of 2xD/c lines) at Nagpur, TSP to supply, install & commission OPGW and earthwire as per Tower Configurations:

- (i) For Multi Circuit Tower Configuration: Two (2) no. OPGW cable containing 24 Fibres (24F) on both the Earthwire peaks
- (ii) For Double Circuit Tower configuration (for both Loop In and Loop Out portion): One (1) no. OPGW cable containing 24 Fibres (24F) to be installed on one earthwire peak & conventional earthwire on other earthwire peak for both Loop In and Loop Out Lines.

The TSP shall install OPGW cables from Gantry of Nagpur (HVDC) up to the LILO tower with all associated hardware including Vibration Dampers, LILO Tower, mid-way & gantry Joint Boxes (called **OPGW Hardware** hereafter) and finally terminate in Joint Boxes at Nagpur (HVDC). The transmission line length of LILO portion is 30 kms (approx.). If after survey repeater is required to meet the link budget requirement of Wardha – Nagpur (HVDC) and Nagpur (HVDC) – Raipur link the same shall be provided by TSP.

TSP shall finalize the location of repeater station depending upon the actual site conditions. Further TSP shall comply to the requirements mentioned as per **Appendix-F.1.**

Maintenance of OPGW Cable, OPGW Hardware & repeater equipment and items associated with repeater shelter shall be responsibility of TSP.

Specific Requirement for Phasor Measurement Units (PMUs)

TSP shall supply, install and commission required no. of Phasor Measurement Units (PMUs) PMUs at all the locations under the scope of TSP under this RFP as per CEA (Technical Standards for Construction of Electrical Plants and Electric Lines) Regulations, 2022 (alongwith all amendments if any), and all the applicable Regulations, Standards, Guidelines issued time to time. These PMUs shall be provided with GPS clock and LAN switch and shall connect with LAN switch of control room of respective substations/ generating stations with Fibre Optic cable. These PMUs shall be connected with the FOTE at Substation/ generating stations for onwards data transmission to the PDC (Phasor Data Concentrator) located at respective RLDC. Configuration work in existing PDC at RLDC for new PMU integration shall be done by respective RLDC, however all the necessary support in this regard shall be ensured

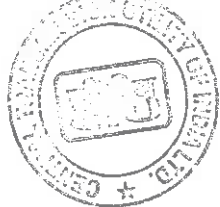

Transmission Service Agreement

by TSP. The maintenance of all the PMUs and associated equipment shall be the responsibility of TSP.

Note: Existing Station owner/s to provide necessary support to integrate different equipment and applications of new extended bays with the existing substation e.g. Communication (through FOTE), Voice etc. for smooth operation and monitoring of new added grid elements.

Central Transmission Utility of India Limited



208

Khavda V-A Power Transmission Limited



263

Repeater Requirements

FOTE to be provided by TSP in repeater station/s shall be 2x STM-16 (FOTE) equipment (in redundant mode connected with separate fibre pairs of same OPGW/UGFO/Approach Cable)

- If the repeater location is finalized in the Control Room of a nearby substation, TSP shall provide 1 no. OPGW (48F) on a single Earthwire peak with OPGW Hardware and mid-way Joint Boxes etc. of the line crossing the main line and 1 no. Approach Cable (48F) with all associated hardware fittings, to establish connectivity between crossing point of main transmission line up to the repeater equipment in substation control room.

TSP shall co-ordinate for Space and DC power supply sharing for each operational communication equipment at repeater station in redundant mode.

TSP shall provide FODP, FOTE (with STM-16 capacity) with suitable interfaces require for link budget of respective link.

OR

- If the repeater location is finalized in the nearby substation premises, the TSP shall identify the Space for repeater shelter in consultation with station owner. Further TSP shall provide 1 no. OPGW (48F) on a single Earthwire peak with OPGW Hardware & mid-way Joint Boxes etc. of the line crossing the main line and 1 no. Approach Cable (48F) / UGFO (48F) with all associated hardware fittings, to establish connectivity between crossing point of main transmission line up to the substation where the repeater shelter is to be housed.

TSP shall provide repeater shelter along with FODP, FOTE (with STM-16 capacity) with suitable interfaces require for link budget of respective link, reliable power supply provisioning for AC and DC supply, battery bank, Air Conditioner and other associated systems for each operational communication equipment at repeater station in redundant mode.

OR

- If the repeater location is finalized on land near the transmission tower. TSP shall make the provisions for Land at nearby tower for repeater shelter. Further TSP shall provide 1 no. Approach Cable (48F) / UGFO (48F) with all associated hardware fittings to establish connectivity up to the location of repeater shelter.

Central Transmission Utility of India Limited

209

Khavda V-A Power Transmission Limited

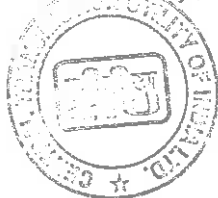

Transmission Service Agreement

TSP shall provide repeater shelter along with FODP, FOTE (with STM-16 capacity) with suitable interfaces require for link budget of respective link, reliable power supply provisioning for AC and DC supply, battery bank, Air Conditioner and other associated systems for each operational communication equipment at repeater station in redundant mode.

Maintenance of OPGW Cable and OPGW Hardware, repeater equipment & items associated with repeater shelter shall be responsibility of TSP.

Central Transmission Utility of India Limited



210

Khavda V-A Power Transmission Limited

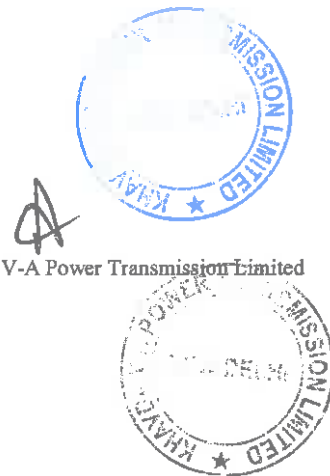

265

Proposed Communication for Transmission System for Evacuation of Power from potential renewable energy zone in Khavda area of Gujarat under Phase-V (8 GW): Part A

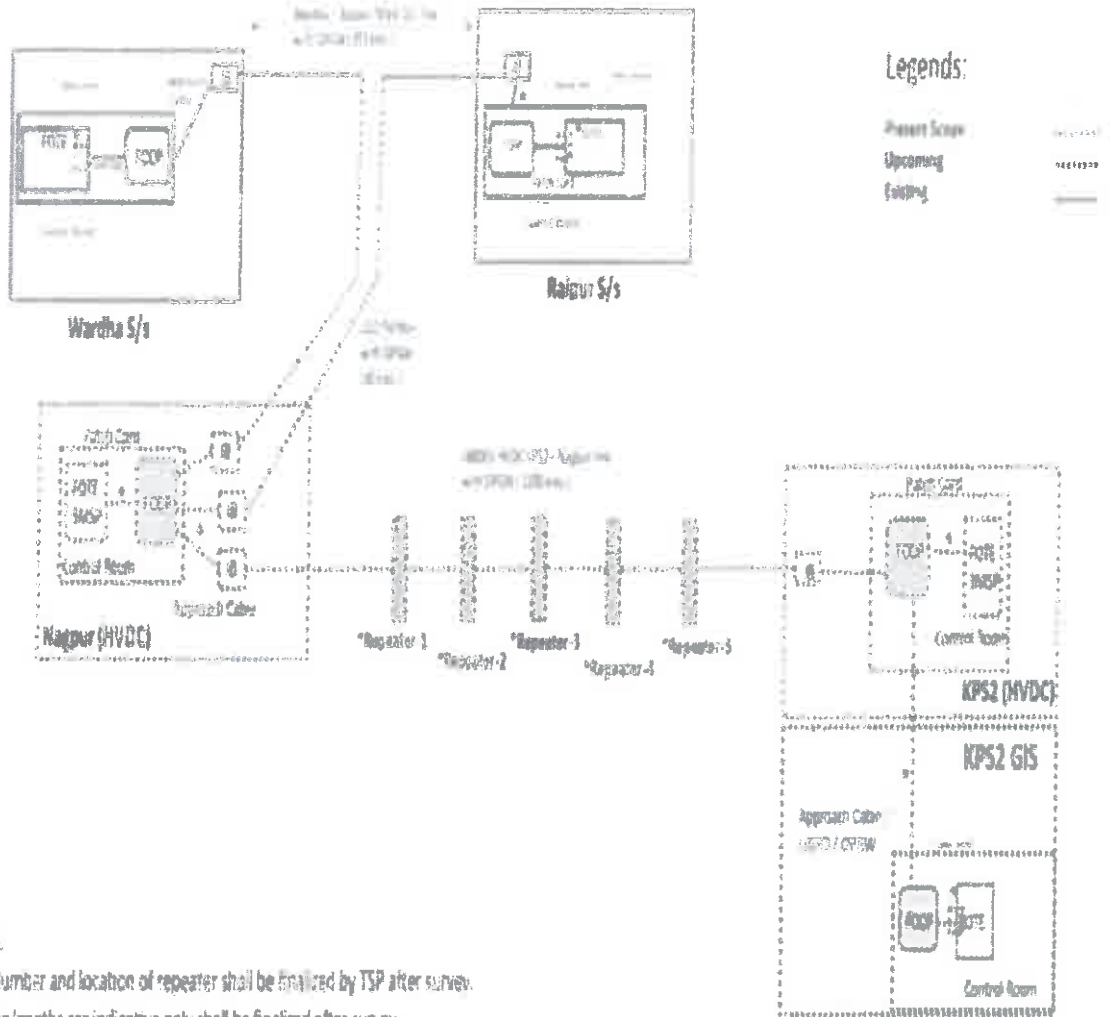
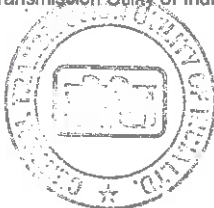

Figure F.1

Central Transmission Utility of India Limited



211

Khavda V-A Power Transmission Limited



Next Generation Firewall (NGFW)

TSP shall provide 2 NGFW one in Main and another in Standby mode having electrical ethernet interfaces/ports and placed between FOTE and SAS gateway/s at the substation. All ethernet based applications shall be terminated in the firewall ports directly (e.g. PMU, AMR, VOIP, SAS/SCADA etc.). Each port of firewall shall work as a separate zone. Firewall shall be hardware based with features of Block/Allow/drop and IPsec VPN (network encryption).

The number of ports/interfaces in each firewall (i.e. Main and Standby) shall be minimum 16 nos. TSP shall provide either single firewall or multiple firewalls to meet this interfaces requirement, each for main as well as standby firewall. Minimum throughput of firewall shall be 300 Mbps.

The Firewall shall be managed/ configured as standalone at present and shall also have compatibility to manage/configure through Centralized Management Console (CMC) remotely in future.

Firewall shall be tested and certified for ISO15408 Common Criteria for least EAL4+. Further, the OEM must certify that it conforms to Secure Product Development Life Cycle requirements as per IEC62443-4-1. The firewall shall generate reports for NERC-CIP Compliance.

The specifications for the firewalls are given at **Annexure-F.2** and schematic diagram showing firewall placement given at **Figure F.2**.

Central Transmission Utility of India Limited



212

Khavda V-A Power Transmission Limited



Specifications of Next Generation Firewall (NGFW)

1. NGFW shall have following features including but not limited to:

Encryption through IPsec VPN (Virtual Private Network), Deep Packet Inspection (DPI), Denial of service (DoS) and Distributed Denial of Service (DDoS) prevention, Port Block/ Allow, rules/ policies for block/allow, IP (Internet Protocol) and Media Access Control (MAC) spoofing protection, threat detection, Intrusion Prevention System (IPS), Anti-Virus, Anti-Spyware, Man In The Middle (MITM) attack prevention.

2. The proposed firewall shall be able to handle (alert, block or allow) unknown /unidentified applications e.g. unknown TCP and UDP packets. It shall have the provision to define application control list based on application group and/or list.
3. Firewall shall have feature and also have capability to update the definition/ Signatures of Anti-Virus online as well as offline. Firewall shall also be compatible to update the definitions/signatures through CMC. There shall be a defined process for security patching and firmware up-gradation. There shall be a feature to field validate firmware checksum. The same shall also be validated before using the OEM provided file/binary in the process of firmware up-gradation and security patching
4. Firewall shall have Management Console port to configure remotely.
5. Firewall shall be EMI/EMC compliant in Substation environment as per IEC 61850-3.
6. Firewall shall be rack mounted in existing standard equipment cabinets.
7. Firewall shall have support of SCADA applications (IEC-60870-5-104), ICCP, PMU (IEEE C37.118), Sub-Station Automation System (IEC 61850), Ethernet and other substation environment protocols.
8. Client based Encryption/ VPN must support different Operating System platforms e.g. Windows, Linux & Mac.
9. The solution must have content and comprehensive file detection policies, blocking the files as function of their types, protocols and directions.
10. Firewall shall have logging facility as per standard logs/events format. Firewall shall have features to export the generated/stored logs/events in csv (Comma Separated Value) and also any other standard formats for offline usage, analysis and compliance. Firewall shall have suitable memory architecture and solution to store and be enable to export all logs/events for a period of last 90 days at any given time.

Central Transmission Utility of India Limited



213

Khavda V-A Power Transmission Limited

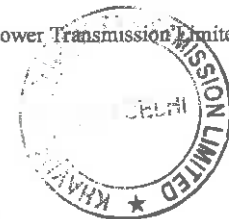

Transmission Service Agreement

11. Firewall shall have features and be compatible with local as well as central authentication system (RADIUS, LDAP, or TACACS+) for user account and access right management. It shall also have Role Based User management feature.
12. Firewall shall have the capability to configure sufficient number of VLANs.
13. Firewall shall have the capability to support sufficient number of sessions.
14. Firewall shall have provision to configure multiple IP Sec VPNs, at least 100 nos., (one-to-many or many-to-one). Shall support redundant operation with a similar router after creation of all the IP Sec VPN. IPsec VPN shall support encryption protocols as AES128, AES256 and hashing algorithms as MD5 and SHA1. IPsec VPN throughput shall support at least 300 Mbps
15. Firewall shall be capable of SNMP v3 for monitoring from Network Management system. It shall also have SNMPv3 encrypted authentication and access security
16. Firewall shall support in Active/Passive or Active-Active mode with High Availability features like load balancing, failover for firewall and IPsec VPN without losing the session connectivity.
17. Firewall should have integrated traffic shaping (bandwidth, allocation, prioritisation, etc.) functionality
18. Shall support simultaneous operation with both IPv4 and IPv6 traffic
19. Firewall shall be compatible with SNTP/NTP or any other standards for clock synchronization
20. Firewall shall have the features of port as well as MAC based security
21. Firewall shall support exporting of logs to a centralized log management system (e.g. syslog) for security event and information management.
22. Firewall time shall be kept synchronised to official Indian Timekeeping agency, time.nplindia.org.
23. Firewall product shall be provided with all applicable updates at least until 36 months since the applicable date of product shipping to the concerned utility.

Central Transmission Utility of India Limited



214

Khavda V-A Power Transmission Limited



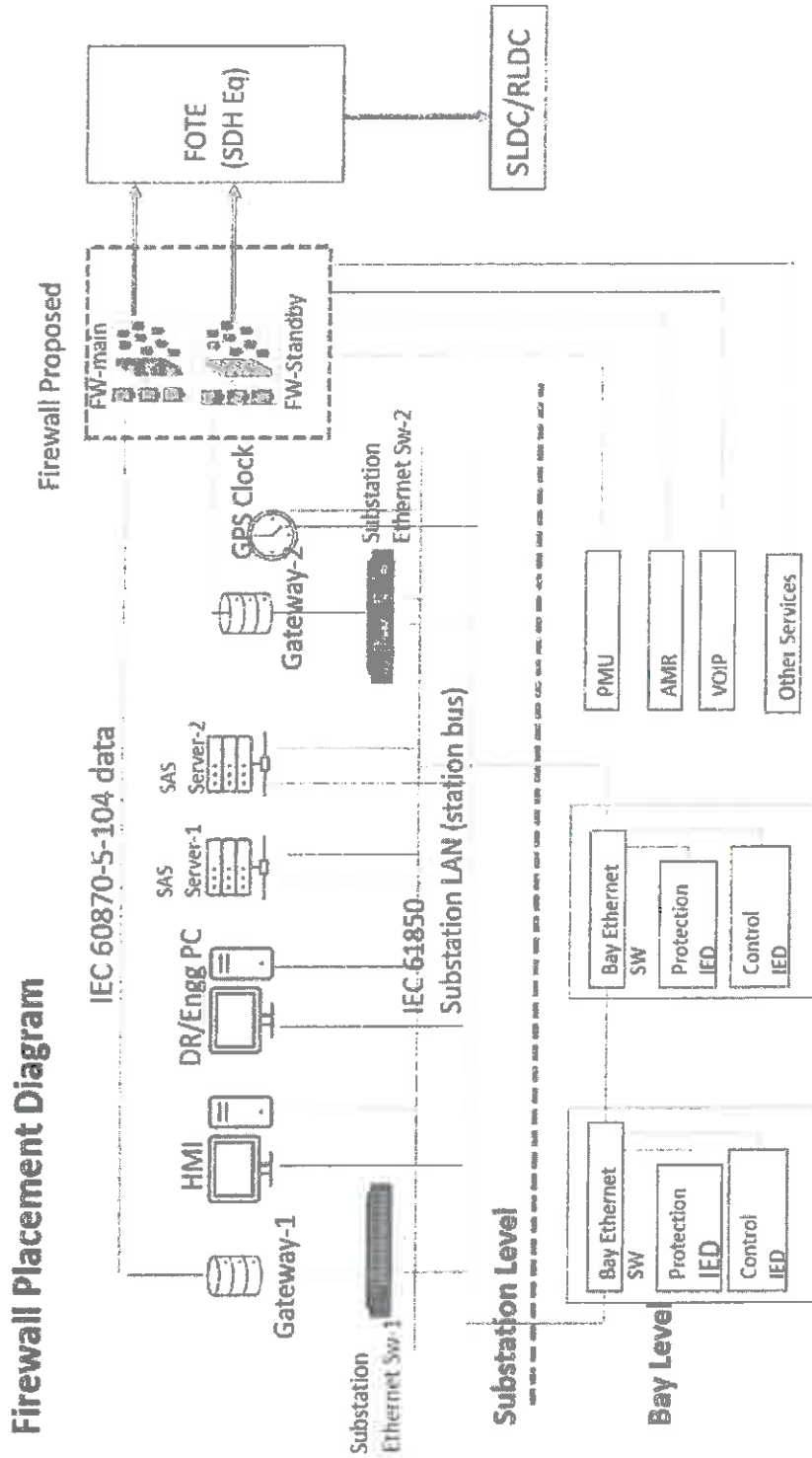
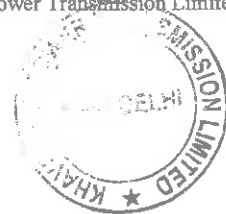

Figure F.2

Central Transmission Utility of India Limited

215

Khavda V-A Power Transmission Limited



270

C.7 PLCC and PABX :

Power line carrier communication (PLCC) equipment complete for speech, tele-protection commands and data channels shall be provided on each transmission line. The protections for transmission line and the line compensating equipment shall have hundred percent back up communication channels i.e. two channels for tele-protection in addition to one channel for speech plus data for each direction. The PLCC equipment shall in brief include the following:

- Coupling device, Coupling filters line traps, carrier terminals, protection couplers, HF cables, PABX (if applicable) and maintenance and testing instruments.
- At new substation, a telephone exchange (PABX) of 24 lines shall be provided at as means of effective communication among various buildings of the substation, remote end substations and with control centers (RLDC/SLDC) etc.
- Coupling devices shall be suitable for phase to phase coupling for 400 kV Transmission lines. The pass band of coupling devices shall have sufficient margin for adding communication channel in future if required. Necessary protection devices for safety of personnel and low voltage part against power frequency voltages and transient over voltage shall also be provided.
- The line traps shall be broad band tuned suitable for blocking the complete range of carrier frequencies. Line Trap shall have necessary protective devices such as lightning arresters for the protection of tuning device. Decoupling network consisting of line traps and coupling capacitors may also be required at certain substation in case of extreme frequency congestion.
- The carrier terminals shall be of single side-band (SSB) amplitude modulation (AM) type and shall have 4 kHz band width. PLCC Carrier terminals and Protection couplers shall be considered for both ends of the line.
- PLCC equipment for all the transmission lines covered under the scheme shall be provided by TSP as per following configuration. PLCC to be provided for following lines under present scope:

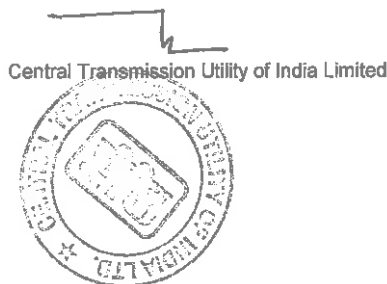

216

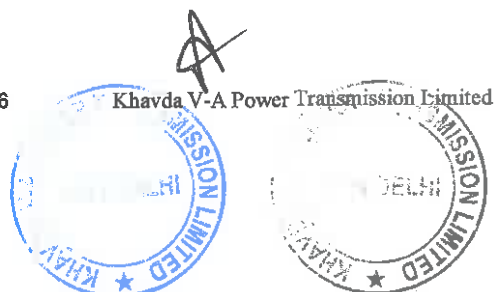

271

Transmission Service Agreement

Sl. No	Line name	PLCC configuration
1	800 kV HVDC Bipole line between KPS2 (HVDC) and Nagpur (HVDC)	2 Sets of Digital Protection Coupler for each circuit at both ends.

In case of the above-mentioned line, wave traps are not required as both the paths for tele-protection are on point to point Optical Ground Wire.

TSP shall provide/undertake necessary addition/ modification/ shifting/ re-commissioning etc. of PLCC equipment due to LILO of transmission lines (wherever applicable).

Sl. No	Line name	PLCC configuration
1.(a)	Wardha – Nagpur 765 kV D/C line [formed after LILO]	1 set Analog PLCC + 1 set Digital Protection Coupler at each end after LILO. Existing PLCC panels may also be utilized.
1.(b)	Raipur – Nagpur 765 kV D/C line [formed after LILO]	1 set Analog PLCC + 1 set Digital Protection Coupler at each end after LILO. Existing PLCC panels may also be utilized.

- All other associated equipment like cabling, coupling device and HF cable shall also be provided by the TSP.
- 2 sets of 48V battery banks for PLCC and communication equipment shall be provided at each new Substation with at least 10 hours battery backup and extended backup, if required.

Central Transmission Utility of India Limited



217

Khavda V-A Power Transmission Limited



272

Frequently Asked Queries:

1.0 Transmission Line:

1.1 Please clarify that whether shutdowns for crossing of existing transmission lines of POWERGRID/STUs/ Power Evacuation Lines from Generation Plants/ Any other Transmission Licensee will be given to TSP on chargeable basis or free of cost.

Reply: Shutdowns for crossing of existing transmission lines of POWERGRID/ STUs/ Power Evacuation Lines from Generation Plants/ Any other Transmission Licensee will be given to TSP by the concerned owner of the lines as per their own terms & conditions. As far as shutdown of ISTS lines are concerned the same can be availed by approaching respective Regional Power Committee.

1.2 We understand that the suggested swing angle criteria are applicable for Suspension Insulator in Suspension Tower. Further, you are requested to provide similar swing angle and clearance criteria for Pilot Insulator with Jumper and Jumper.

Reply: It is clarified that the swing angle criteria (as mentioned in RFP) for transmission lines is applicable for Suspension Insulator in Suspension Tower. Further, as per Clause 3.0 of Specific Technical Requirements for transmission lines, Transmission service Provider (TSP) shall adopt any additional loading/design criteria for ensuring reliability of the line, if so desired and /or deemed necessary.

1.3 We request you to kindly allow that use of diamond configuration at Power line crossings and the existing owner of the lines may be directed to allow the same for the successful bidders.

Reply: Power line crossing including Diamond configuration is responsibility of the TSP. TSP shall formally submit the profile of the crossing section to the owner of the existing line suggesting proposed crossing alternatives. The crossing will have to be carried out as per approval of owner of the existing line.

1.4 It is requested you to kindly provide present status of Forest Clearances if any transmission line corridor area falling in wildlife forest / reserve forest/ mangroves..

Reply: Based on the preliminary route survey, the process of initiation of forest clearance for the forest stretches, if any, enroute the proposed line alignment will be initiated by way of writing letters to the concerned authority(ies). However, it may be noted that it will be the responsibility of TSP for obtaining forest clearance for the forest stretches as provided in the survey report and also for any forest area encountered during

Central Transmission Utility of India Limited

218

Khavda V-A Power Transmission Limited

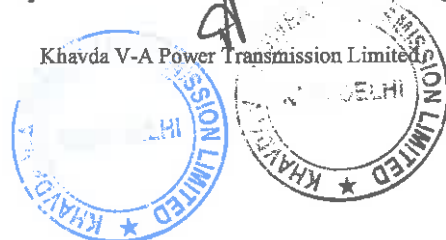

273

detailed survey.

2.0 Substation

2.1 We understand that space for storage of O&M spare shall be provided by existing owner within the station boundary without any cost. Kindly confirm.

Reply: Space for storage of O&M spares shall be arranged by TSP on its own.

2.2 We presume that the O&M for the end Termination bays will be in the scope of the TSP and TSP shall not be liable for any payment towards O&M to the existing owner of the substation. Kindly confirm.

Reply: Operation and maintenance of the bays is solely responsibility of the TSP. TSP shall follow CEA's "Operation and Maintenance (O&M) guidelines and Standard Format for Memorandum of Understanding between New TSP and Existing TSP" issued by CEA vide its letter No. I/28514/2023 dated 22.06.2023.. Copy of the guideline is available on CEA website at following link:

https://cea.nic.in/wp-content/uploads/pse___td/2023/06/om_guidelines.pdf

2.3 With reference to subject scheme of existing sub-station, we assumed following scope of work:

- (a) We assumed internal road is available and need not to consider in the present scope of work.
- (b) Drainage is available and need not to consider in the present scope of work.
- (c) Cable trench extension in adjacent to Main cable trench only under present scope of work.
- (d) Levelled area being provided by developer for bay extension.

Reply: Regarding requirement of internal road, drainage, cable trench, leveling of the bay extension area, bidder is advised to visit site and acquaint themselves with the provisions/facilities available at substation.

2.4 Kindly provide the soil investigation report of soil parameters of existing substation.

Reply: Bidder is advised to visit the substation site and ascertain the requisite parameters.

2.5 Kindly confirm, energy accounting of aux. power consumption. Whether it will be on chargeable basis or part of transmission loss.

Reply: It will be on chargeable basis.

2.6 We understand that VMS requirement is for unmanned stations only. For Manned stations VMS is not compulsory.

Reply: VMS shall be provided in line with requirements of RfP document.

2.7 It is understood that Construction water and power shall be provided free of cost

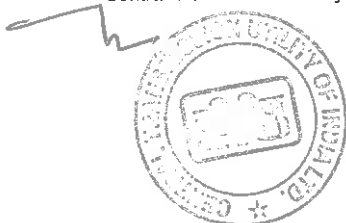

to TSP by respective substation owner for construction of new bays.

Reply: Arrangement of construction power and water is in the scope of TSP.

- 2.8 It is understood that existing fire hydrant system shall be extended by the TSP for bay extension.

Reply: Existing fire hydrant system shall be extended from existing system (if required)

- 2.9 Please clarify that Status of land acquisition for Substations. Whether the lands have been acquired by BPC and will be transferred to TSP.

Reply: The acquisition of land for substation is in the scope of TSP.

- 2.10 We understood that no dedicated metering CT and CVT required for Line/feeders. Further, we understood that requisite Energy meters for various 765 kV, 400 kV & 220 kV Feeders shall be provided and installed by CTU free of cost to TSP.

Reply: Dedicated metering CT and CVT are not required for line/feeders. Metering core of existing CT/CVT can be used provided accuracy class is matching with metering requirement. Requisite Special Energy Meters shall be provided and installed by CTU at the cost of TSP in C&P panel subject to space availability, else, in separate metering panel (to be provided by TSP at its cost).

3.0 Communication

- 3.1 What are the usage of OPGW, FOTE, PMU etc. under communication requirement of RFP?

Reply: User shall be responsible for providing compatible equipment along with appropriate interface for uninterrupted communication with the concerned control center and shall be responsible for successful integration with the communication system provided by CTU.

Communication systems e.g. OPGW, FOTE, PMU etc. are required for grid operation through RLDC/SLDC, speech communication, tele-protection and tele-metering.

- 3.2 Is space for installation of communication panels are provided to TSP in existing Substations incase new bays are in the scope of TSP?

Reply: The space related issues are deliberated in the RFP itself. TSP to carry out survey of the existing substation for physical space requirement. In case space is not available in the existing substation then TSP shall accommodate the same in the respective bay SPR (Switchyard Panel Room)/Bay Kiosk/ Relay panel room in case of GIS s/s. Further, TSP to connect and integrate the proposed FOTE with the existing FOTE in the control room.

In Case 132 kV Substation TSP shall accommodate the said panels either by extension of existing control room or other arrangements.

- 3.3 How is the OPGW laying done in case of LILO lines?

Reply: In case LILO lines are on same towers (e.g. both Line in and Line Out



portion are on same towers, generally done LILO of S/C lines). Then 2x24F OPGW shall be required to install by TSP on both earthwire peak on 400 kV & 765 kV lines where two E/W peaks are available. On 220 & 132 kV lines where only one E/W peak is available TSP to install one no. 48F OPGW.

Incase LILO lines are on different towers (e.g. both Line In and Line Out portion are on different towers, generally done LILO of D/C lines). Then 1x24F OPGW shall be required to install by TSP on one earthwire peak, on both Line in and Line Out portions of 400 kV & 765 kV lines. On 220 & 132 kV lines where only one E/W peak is available TSP to install one no. 24F OPGW in place of conventional earthwire.

3.4 How is the OPGW laying done in case Multi circuit Towers?

Reply: In case two different lines are using common multi circuit portion for some distance (originating from different stations, may be terminating on same or on different stations). Two no. 24F OPGW to be installed on both E/W peaks for common M/C portion of 765 kV and 400 kV lines.

In case 220/132 kV lines using multi circuit portion where single E/W peak is available one no. 48F may be installed for common multi circuit portion.

Central Transmission Utility of India Limited



221

Khavda V-A Power Transmission Limited

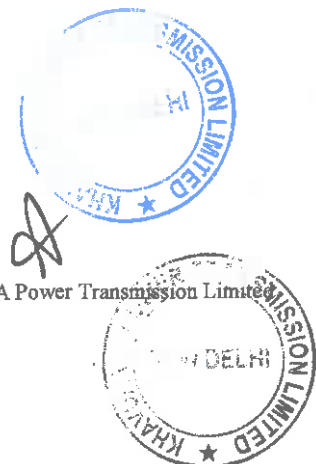

Appendix C.6

TECHNICAL REQUIREMENTS FOR THE REPLICA-SIMULATOR SETUP

1. Scope

The document mentions technical requirements that should be considered by the TSP for the implementation of one real-time laboratory for the Factory System Test (FST), commissioning, operation, training and optimization of KPS2-Nagpur parallel bipole (Bipole 1 and Bipole 2) HVDC systems in a large AC Grid. Considering the strategic importance, complexity of controls and protection, operation and dynamic performance of the bipole system, the simulation facility shall include bipole replica – real time simulator setup.

It shall be in the scope of TSP to have ± 800 kV, 6000 MW KPS2-Nagpur Bipole control and protection replica hardware (without redundancy) for both bipoles along with simulator. The software and hardware design philosophy of control and protection replica shall be based on the design of ± 800 kV, 6000 MW KPS2-Nagpur HVDC Parallel Bipole system. However, the replica shall be reconfigurable by changing parameters in the controllers. . The scope shall also include to keep simulator interface panel, station HMI, Transient Fault Recorder, Station GPS clock, network equipment, Uninterrupted Power Supply (UPS) system, communication cables, cable trays/racks, tools and tackles, suitable furniture including operator desk, spares and other accessories required to implement KPS2-Nagpur Bipole control and protection system.

The Dynamic performance test (DPS)/ Factory System Test (FST) for ± 800 kV, 6000 MW KPS2-Nagpur HVDC system shall be carried out with simulator and the same simulator shall be kept by TSP. The simulator shall contain AC network modeled as both i) voltage sources behind short circuit impedance and ii) detailed AC equivalent network as specified in TS to carry out test cases with both options.

The spare cards/ modules including maintenance spares, communication cables etc. required for operation and maintenance of the replica system and simulator shall also be a part of supply. Minimum 10% spares shall be provided. The UPS provided for replica simulator system shall have additional capacity of 10 kVA. The manufacturer of UPS shall have an operational authorized maintenance and support center in India at the time of award of the contract.

The TSP shall ensure support from OEM for KPS2-Nagpur Bipole control and protection replicas (Bipole 1 and Bipole 2) and simulator, for debugging the faults related to software and hardware and to provide software updates and hardware support for the useful life of the project.

Central Transmission Utility of India Limited

222

Khavda V-A Power Transmission Limited

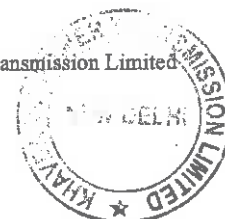

277

The Replica and Simulator system shall be made available free of charge for conducting studies and tests proposed by CEA/CTUIL/Grid-India.

2. Main specifications of simulator for Real-Time Laboratory

The Simulators for Real-Time Laboratory must comply with the following specifications.

2.1.1 Real-Time Simulation Laboratory Capability

Considering the strategic importance, complexity of controls and protection, operation and dynamic performance of the HVDC system, the simulation facility shall include a Large Scale Real-Time Simulator (LSRTS). The real-time simulation facility will enable the CEA/CTUIL/Grid India to conduct system planning, operation and engineering studies with hardware/software in the loop as needed at different stages of the project.

2.1.2 Specification of Real-Time Simulator

2.1.2.1 Simulation Capability

For the Dynamic performance test/ Factory System Test, the complete AC-system shall be represented by an equivalent network.

The simulator must be able to simultaneously simulate following:

(i) The complete parallel bipole DC system (LCC) with all converters, DC and AC equipment, and AC/DC filter bank and other associated equipment that shall be delivered at each station of the KPS2-Nagpur HVDC system.

(ii) The detailed model of each controller of the parallel bipole systems shall include all HVDC controllers, filter bank controllers.

The AC grid that will be connected to the HVDC system terminals with the following capabilities:

(i) One equivalent AC system at each terminal of the HVDC system with the possibility to modify, short-circuit inductances, resonance conditions and damping, while the simulator is running.

(ii) Detailed dynamic equivalent AC system model with at least 200 3-phase busses including a minimum of 100 transmission lines, 50 generators modeled in details with controllers, 75 (3-ph) transformers with saturation, 25 (3-ph) fixed-impedance loads and 25 dynamic loads, 20 (3-ph) arrestors, models of 5 HVDC, 10 SVCs, 20 STATCOMs and 10 TCSCs, 50 Inverter Based Resources (IBR) alongwith associated Power plant controllers (PPCs).

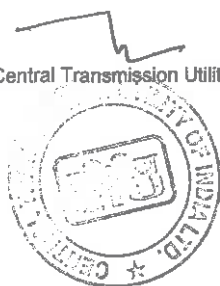

2.1.2.2 Input-Output Interface

The real-time simulator must also have all necessary digital input-output systems to interface with detailed replicas (the actual control and protection system for bipole) of all HVDC controllers that shall be supplied as part of the bipole project

2.2 Operating flexibility, modularity and re-configurability

2.2.1 Real-Time and Non-Real-Time Simulation

The real-time simulator must be able to operate in real-time simulation mode with IO interface and non-real-time simulator in non-real-time simulation mode using the same HVDC and EHVAC grid models. In non-real-time simulation mode, the simulator shall have the capability to execute simple and detailed models of HVDC, SVC and other FACTS controllers used for this project.

2.2.2 Minimum Simulation Time Step and Advanced Converter Models

The real-time simulator shall have the capability to simulate in real time with integration time step of not more than 50 microseconds for the entire - bipole system, AC reactive compensation equipment, converters, and HVDC simulation, in order to reduce the number of processors, the detailed AC system may have integration time step of 50 microseconds or less.

TSP shall seek Simulator suppliers to propose advanced switching algorithms and converter models to reach an effective switching/ firing resolution better than 10 microsecond for the slow variation of converter power as required for verifying the damping of SSR controller. The required time steps shall also be programmable. Controller shall specify any additional requirement to the Simulator supplier as necessary to meet their test objectives for the delivery of the bipole system.

2.2.3 Voltage Source Converter (VSC) Power Electronic System Simulation

Following generic models shall be supplied.

Digital simulators should be optimized for the simulation of VSC power electronic systems integrated with large power grids. Furthermore, the proposed simulator must be designed to handle models with several thousands of individually controlled IGBTs as applicable used to implement modern multi-level VSC converters.

The proposed simulator should also be able to simulate DC-AC and AC-DC three-phase power converter models built with fast power electronic devices (MOSFET, IGBT), typical of those used in micro-grids or distributed energy generation (concentrated solar cell, micro-gas turbine, photovoltaic generator, biomass, combined heat and power, battery storage system) should also be simulated accurately in real-time.

Central Transmission Utility of India Limited



Khavda V-A Power Transmission Limited



These very fast IGBT-based power electronic systems, which can performance of conventional and modern protection systems, require much smaller simulation time step values than what can be achieved through the use of conventional DSP-based real-time simulators optimized for power grid simulation.

The TSP shall seek the Supplier to provide a fully flexible VSC sub-network whereby the user can freely configure the valve topology for Modular Multi level converter (minimum 512 full bridge sub-modules per valve), crowbar circuitry, filters, etc. and still achieve the required firing accuracy.

The TSP shall seek Supplier to demonstrate that MMC based voltage source converters have a continuously variable firing instant with a resolution of 3 microseconds or better. In addition, the TSP shall also seek Supplier to demonstrate capability to simulate in real-time a chain link VSC converter model used in AC-DC-AC converters and FACTS with thousands of individually controlled switches similar to chain-link VSC systems offered by major suppliers.

influence the

2.3 Simple and Complex Controller Numerical Models

The Bipole HVDC systems shall consist of the following models.

2.3.1 Preliminary Models for Phasor -Type Simulation tools

These preliminary models shall include all basic control functions used for similar projects and developed for transient stability software used by CEA/CTU/Grid India/TSP such as PSS/E.

2.3.2 Preliminary Models for Electro-Magnetic Transient type (EMT) Simulation Tools

These preliminary models shall include all typical control and protection functions used for similar projects and developed for EMT simulation tools such as PSCAD.

2.3.3 Detailed Models for Electro-Magnetic Transient (EMT) - type Simulation Tools

These models shall include all control and protection functions that will be used in controllers to be delivered for this project. TSP shall deliver several versions of these controllers developed at different phases of the project to enable CEA/CTU/Grid India/TSP to make simulation and analysis of the impact of the - bipole system on the remaining parts of the AC grid.

3 Preferred Technology Specifications

Central Transmission Utility of India Limited

225

Khavda V-A Power Transmission Limited..

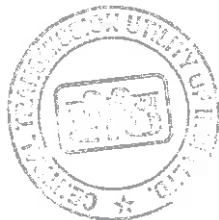

280

The following specifications in this clause are not mandatory but important optional items that will be used to select the real-time simulator technology fulfilling the mandatory specification items given in clause 2 above.

3.1 Off-the Shelf Software Technologies

The proposed simulator may take full advantage of off-the-shelf standard computer technology and commercially available software such as MATLAB, SIMULINK and SimPower Systems.

The proposed simulator should also be interfaced with PSCAD, the industry standard software for simulation and analysis of electromagnetic transients in power systems. Such non-real-time interface is very important for the model verification and to compare the results obtained from the real-time simulator with the results obtained from well-known non-real-time simulation tools accepted by the industry. The proposed simulator shall include interface software to facilitate the translation of the models used by PSCAD to the real-time simulator circuit data.

3.2 Scalability: Off-the-shelf multi-core Processor Board and Communication Fabric

The proposed digital real-time simulators may take full advantage of modern multi-core processors as soon as they become available from AMD or INTEL. Models should then be executed in - with minimum communication overhead by using on-chip and on-board shared memory. The real-time simulators may be implemented using very fast and low-latency commercial communication fabric to take advantage of communication technology evolution.

3.3 Advanced User-programmable FPGA-based I/O Systems and Co-Processors

3.3.1.1 User programmable FPGA chips and Development Software

The proposed simulator may include fast FPGA chips that can be programmed by users through graphical interface to implement specialized communication protocols, signal processing, control and protection systems.

3.3.1.2 Implementation of HVDC Controllers with time step below 1 micro-second

Users may have access to large FPGA chips so that TSP is able to implement their own models or models developed by universities of research centers.

Users may be able to implement fast PWM power converters and machine models with timestep below 500 nanoseconds used in distributed energy systems and wind farms.

Central Transmission Utility of India Limited



226

Khavda V-A Power Transmission Limited



3.4 Operating Under Windows for offline Simulation

It may be possible to execute the simulator software on standard Windows multi-core computer for non-real-time simulation to execute the same model used for real-time simulation. The simulator software may take full advantage of all processors cores available on the workstation or on the computer server to execute the simulation as fast as possible.

This feature would be useful to execute several optimization and Monte Carlo studies in nonreal-time mode before executing real-time simulations with actual controllers.

3.5 Interface with Physical Modeling Tools

The simulator may be interfaced with physical modeling tools such as tools from the Mathworks, Dassault (Dymola), LMS (AMEsim) and other tools specialized for mechanical, fluid dynamic and other systems usually integrated with electrical systems. This feature may become important for the simulation of distributed energy systems including wind farms, fuel cells and other equipment requiring complex model available in Simulink but not readily available with conventional real-time simulators.

3.6 Prototyping controller/protection systems

The proposed simulators may include optional single-processor prototyping systems to implement controller or protection system algorithms in real-time on separate computers.

These prototyping systems should have all necessary input-output interfaces to enable its connection with the main simulators.

3.7 I/O Driver Development Software and Source Code

The simulator supplier shall supply the source code and documented application examples to enable TSP and its suppliers to develop and implement software interface with custom or third-party input-output interface boards used to communicate with other equipment or other

real-time simulators. The source code example shall enable to implement fast and low latency communication interface with a maximum latency of 10 microseconds to transfer a data packet of 500 bytes in both directions.

4. Training on Control Replica

As a part of project, it shall be under the scope of TSP to provide the training for 15 man- months to the officials from CEA/CTU/Grid India regarding control/protection

Central Transmission Utility of India Limited

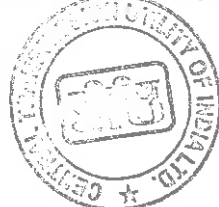

227

Khavda V-A Power Transmission Limited



Transmission Service Agreement

aspects of control replica / simulator in addition to its own manpower for the project.

5. Access to Control replica

The TSP shall provide full access to control replica/simulator to CEA/CTU/Grid India officials whenever required.

Central Transmission Utility of India Limited

228

Khavda V-A Power Transmission Limited



Schedule: 2

Scheduled COD

[Note: As referred to in the definition of "Element", "Scheduled COD", and in Articles 3.1.3 (c), 4.1 (b) and 4.3 (a) of this Agreement]

Sl. No.	Name of the Transmission Element	Scheduled COD in months from Effective Date	Percentage of Quoted Transmission Charges recoverable on Scheduled COD of the Element of the Project	Element(s) which are pre-required for declaring the commercial operation (COD) of the respective Element
1A.#	Establishment of 3000 MW, \pm 800 kV KPS2 (HVDC) [LCC] terminal station (2x1500 MW) (Bipole-1) along with associated interconnections with 400 kV HVAC Switchyard*.	48 months for Bipole-1 (2x1500 MW) and all other elements [mentioned at Sl. 1A, 2A, 3, 4, 5 & 6] (19/11/2028)	31.03%	All Elements (except Bipole 2 (2x1500MW)) are required to be commissioned simultaneously in 48 months as their utilization is dependent on commissioning of each other. The Bipole-2 (2x1500MW) shall be commissioned in 54 months.
2A#	Establishment of 3000 MW, \pm 800 kV Nagpur (HVDC) [LCC] terminal station (2x1500 MW) (Bipole-1) along with associated interconnections with 400 kV HVAC Switchyard*			
1B#	Establishment of 3000 MW, \pm 800 kV KPS2 (HVDC) [LCC] terminal station (2x1500 MW) (Bipole-2) along with associated interconnections with 400 kV HVAC Switchyard*.	54 months for Bipole-2 (2x1500 MW) [mentioned at Sl. 1B & 2B] (from date of SPV transfer). (19/05/2029)	31.03%	
2B#	Establishment of 3000 MW, \pm 800 kV Nagpur (HVDC) [LCC] terminal station (2x1500 MW) (Bipole-2) along with associated interconnections with 400 kV HVAC Switchyard*			
3.	\pm 800 kV HVDC Bipole line (Hexa lapwing) between KPS2 (HVDC) and Nagpur (HVDC) (1200 km) (with Dedicated Metallic Return) (capable to evacuate 6000 MW with overload as specified)		37.94%	
4.	Establishment of 6x1500 MVA, 765/400 kV ICTs at Nagpur-S/s along with 2x330 MVAR (765 kV) & 2x125			

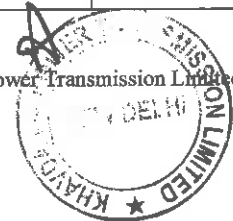

Transmission Service Agreement

Sl. No.	Name of the Transmission Element	Scheduled COD in months from Effective Date	Percentage of Quoted Transmission Charges recoverable on Scheduled COD of the Element of the Project	Element(s) which are pre-required for declaring the commercial operation (COD) of the respective Element
	MVAR, 420 kV bus reactors along with associated interconnections with HVDC Switchyard*. The 400 kV bus shall be established in 2 sections through 1 set of 400 kV bus sectionaliser so that 3x1500 MVA ICTs are placed in each section. The bus sectionaliser shall be normally closed and may be opened based on Grid requirement.			
5.	LILO of Wardha – Raipur 765 kV one D/c line (out of 2xD/c lines) at Nagpur			
6.	Installation of 240 MVAR switchable line reactor at Nagpur end on each ckt of Nagpur – Raipur 765 kV D/c line			

* The 400 kV interconnections (along with all associated equipment/ bus extension, etc.) between HVDC & HVAC switchyards shall be implemented by the TSP

#Scope w.r.t. 6000 MW, ± 800 kV HVDC [LCC] terminal station (4x1500 MW) at KPS2 & Nagpur has been split into 3000 MW, ± 800 kV HVDC [LCC] terminal station (2x1500 MW) Bipole-1 (Sl. 1A & 2A) and 3000 MW, ± 800 kV HVDC [LCC] terminal station (2x1500 MW) Bipole-2 (Sl. 1B & 2B).

Note:

The payment of Transmission Charges for any Element, irrespective of its successful commissioning on or before its Scheduled COD, shall only be considered after successful commissioning of the Element(s), which are pre-required for declaring the commercial operation of such Element as mentioned in the above table.

Scheduled COD for the Project: 54 Months (19/05/2029)

[Note: List of Element(s) along with the critical Element(s) to be provided by CEA]

Central Transmission Utility of India Limited

230

Khavda V-A Power Transmission Limited



285

Schedule: 3

Safety Rules and Procedures

[Note: As referred to in Articles 5.6 of this Agreement]

1: Site Regulations and Safety:

The TSP shall establish Site regulations within sixty (60) days from fulfilment of conditions subsequent, as per Prudent Utility Practices setting out the rules to be observed till expiry of the Agreement at the Site and shall comply therewith.

Such Site regulations shall include, but shall not be limited to, rules in respect of security, safety of the Project, gate control, sanitation, medical care, and fire prevention, public health, environment protection, security of public life, etc.

Copies of such Site regulations shall be provided to the Nodal Agency and the CEA for the purpose of monitoring of the Project.

2: Emergency Work:

In cases of any emergency, the TSP shall carry out all necessary remedial work as may be necessary.

If the work done or caused to be done by any entity, other than the TSP, the TSP shall, reimburse the actual costs incurred, to the other Party carrying out such remedial works.

3: Site Clearance:

In the course of execution of the Agreement, the TSP shall keep the Site reasonably free from all unnecessary obstruction, storage, remove any surplus materials, clear away any wreckage, rubbish and temporary works from the Site, and remove any equipment no longer required for execution of the Agreement. After completion of all Elements of the Project, the TSP shall clear away and remove all wreckage, rubbish and debris of any kind from the Site, and shall leave the Site clean and safe.

4: Watching and Lighting:

The TSP shall provide and maintain at its own expense all lighting, fencing, and watching when and where necessary for the proper construction, operation, maintenance / repair of any of the Elements of the Project, or for the safety of the owners and occupiers of adjacent property and for the safety of the public, during such maintenance / repair.

Central Transmission Utility of India Limited

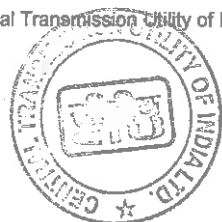

231

Khavda V-A Power Transmission Limited



286

Schedule: 4

Computation of Transmission Charges

1.1 General

The Monthly Transmission Charges to be paid to the TSP for providing Transmission Service for any Contract Year during the term of the Agreement shall be computed in accordance with this Schedule and paid as per Sharing Regulations.

Illustration regarding payment of Transmission Charges under various scenarios (considering definitions of Contract Year, Expiry Date & Monthly Transmission Charges above) is as below: -

Illustration-1: In case the Project Elements achieve COD as per Schedule

Quoted Transmission Charges: **Rs. 140 Million**

Completion Schedule:

Element No.	Completion Schedule in Months	Scheduled CoD of the Element	Actual CoD of the Element	% Charges recoverable on Scheduled CoD of the Element
Element 1	28	1-Feb-2018	1-Feb-2018	25%
Element 2	38	1-Dec-2018	1-Dec-2018	75%

Tariff Payable as follows:

Transmission Charges for Element 1			Transmission Charges for Element 2		
1-Feb-18 to 31-Mar-18	140 X 25% X ((28+31)/365)	5.65		--	0.00
1-Apr-18 to 30-Nov-18	140 X 25% X (244/365)	23.39		--	0.00
1-Dec-18 to 31-Mar-19	140 X 100% X (121/365)				46.41
2	140 X 100% X 1				140
3	140 X 100% X 1				140
4	140 X 100% X 1				140
5	140 X 100% X 1				140
.....					
.....					
36 (1-Apr to 30-Nov)	140 X 100% X (244/365)				93.59

Illustration-2: In case of extension of Scheduled COD as per Article 4.4.1 & 4.4.2 of this Agreement

Central Transmission Utility of India Limited

232

Khavda V-A Power Transmission Limited



Transmission Service Agreement

Quoted Transmission Charges: Rs. 140 Million

Completion Schedule:

Element No.	Completion Schedule in Months	Scheduled CoD of the Element	Actual CoD of the Element	% Charges recoverable on Scheduled CoD of the Element
Element 1	20	1-Feb-2018	1-Jul-2018	25%
Element 2	28	1-Oct-2018	1-Dec-2018	75%

Tariff Payable as follows:

Transmission Charges for Element 1			Transmission Charges for Element 2		
1-Feb-18 to 31-Mar-18	--	0.00		--	0.00
1-Apr-18 to 30-Jun-18	--	0.00		--	0.00
1-Jul-18 to 30-Nov-18	140 X 25% X (153/365)	14.67		--	0.00
1-Dec-18 to 31-Mar-19	140 X 100% X (121/365)				46.41
2	140 X 100% X 1				140
3	140 X 100% X 1				140
4	140 X 100% X 1				140
5	140 X 100% X 1				140
.....					
.....					
36 (1-Apr to 30-Nov)	140 X 100% X (244/365)				93.59

Central Transmission Utility of India Limited



233

Khavda V-A Power Transmission Limited



Transmission Service Agreement

Illustration-3: In case of delay in achieving COD of Project & all individual Elements (COD of the Project achieved in Contract Year 1)

Quoted Transmission Charges: Rs. 140 Million

Completion Schedule:

Element No.	Completion Schedule in Months	Scheduled CoD of the Element	Actual CoD of the Element	% Charges recoverable on Scheduled CoD of the Element
Element 1	20	1-Feb-2018	1-Dec-2018	25%
Element 2	28	1-Oct-2018	1-Dec-2018	75%

Tariff Payable as follows:

Transmission Charges for Element 1			Transmission Charges for Element 2		
1-Feb-18 to 31-Mar-18	--	0.00		--	0.00
1-Apr-18 to 30-Sept-18	--	0.00		--	0.00
1-Oct-18 to 30-Nov-18	--	0.00	1-Oct-18 to 30-Nov-18	--	0.00
1-Dec-18 to 31-Mar-19	140 X 100% X (121/365)				46.41
2	140 X 100% X 1				140
3	140 X 100% X 1				140
4	140 X 100% X 1				140
5	140 X 100% X 1				140
.....					
.....					
36 (1-Apr to 30-Nov)	140 X 100% X (244/365)				93.59

Central Transmission Utility of India Limited

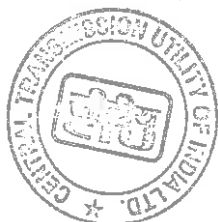

234

Khavda V-A Power Transmission Limited



Transmission Service Agreement

Illustration-4: In case of delay in achieving COD of Project & all individual Elements (COD of the Project achieved in Contract Year other than Contact Year 1)

Quoted Transmission Charges: **Rs. 140 Million**

Completion Schedule:

Element No.	Completion Schedule in Months	Scheduled CoD of the Element	Actual CoD of the Element	% Charges recoverable on Scheduled CoD of the Element
Element 1	38	1-Oct-2019	1-May-2020	25%
Element 2	38	1-Oct-2019	1-May-2020	75%

Tariff Payment to be paid as:

Transmission Charges for Element 1			Transmission Charges for Element 2		
1-Oct-19 to 31-Mar-20	--	0.00	1-Oct-19 to 31-Mar-20	--	0.00
1-Apr-20 to 30-Apr-20	-	0.00	1-Apr-20 to 30-Apr-20	-	0.00
1-May-20 to 31-Mar-21	140 X 100% X (335/365)			128.49	
2	140 X 100% X 1			140	
3	140 X 100% X 1			140	
4	140 X 100% X 1			140	
5	140 X 100% X 1			140	
.....					
.....					
36 (1-Apr to 30-Apr)	140 X 100% X (30/ 365)			11.51	

Central Transmission Utility of India Limited



235

Khavda V-A Power Transmission Limited

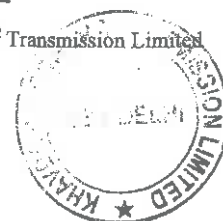

Transmission Service Agreement

Illustration5: In case of delay in achieving COD of Element but Project COD achieved on time

Quoted Transmission Charges: **Rs. 140 Million**

Completion Schedule:

Element No.	Completion Schedule in Months	Scheduled CoD of the Element	Actual CoD of the Element	% Charges recoverable on Scheduled CoD of the Element
Element 1	20	1-Feb-2018	1-Jul-2018	25%
Element 2	30	1-Dec-2018	1-Dec-2018	75%

Tariff Payable as follows:

Transmission Charges for Element 1			Transmission Charges for Element 2		
1-Feb-18 to 31-Mar-18	--	0.00		--	0.00
1-Apr-18 to 30-Jun-18	--	0.00		--	0.00
1-Jul-18 to 30-Nov-18	140 X 25% X (153/365)	14.67		--	0.00
1-Dec-18 to 31-Mar-19	140 X 100% X (121/365)				46.41
2	140 X 100% X 1				140
3	140 X 100% X 1				140
4	140 X 100% X 1				140
5	140 X 100% X 1				140
.....					
.....					
36 (1-Apr to 30-Nov)	140 X 100% X (244/365)				93.59

Central Transmission Utility of India Limited

236

Khavda V-A Power Transmission Limited



Transmission Service Agreement

Illustration-6: In case of early commissioning of Project

Quoted Transmission Charges: Rs. 140 Million

Completion Schedule:

Element No.	Completion Schedule in Months	Scheduled CoD of the Element	Actual CoD of the Element	% Charges recoverable on Scheduled CoD of the Element
Element 1	38	1-Oct-2019	1-Jul-2019	25%
Element 2	38	1-Oct-2019	1-Jul-2019	75%

Tariff Payment to be paid as:

Transmission Charges for Element 1		Transmission Charges for Element 2	
1-July-19 to 31-Mar-20	140 X 100% X (274/365)		105.09
2	140 X 100% X 1		140
3	140 X 100% X 1		140
4	140 X 100% X 1		140
5	140 X 100% X 1		140
.....			
.....			
36 (1-Apr to 30-Jun)	140 X 100% X (91/365)		34.91

Central Transmission Utility of India Limited

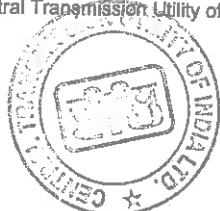

237

Khavda V-A Power Transmission Limited



292

Illustration-7: In case of early commissioning of an element

Quoted Transmission Charges: **Rs. 140 Million**
Completion Schedule:

Element No.	Completion Schedule in Months	Scheduled CoD of the Element	Actual CoD of the Element	% Charges recoverable on Scheduled CoD of the Element
Element 1	38	1-Oct-2019	1-Apr-2019	25%
Element 2	38	1-Jul-2019	1-Jul-2019	75%

Tariff Payment to be paid as:

Transmission Charges for Element 1			Transmission Charges for Element 2		
1-Apr-2019 to 30-Jun-19	140 X 25% X (91/365)	8.72	1-Apr-2019 to 30-Jun-19	--	0.00
1-July-19 to 31-Mar-20	140 X 100% X (274/ 365)				105.09
2	140 X 100% X 1				140
3	140 X 100% X 1				140
4	140 X 100% X 1				140
5	140 X 100% X 1				140
.....					
.....					
36 (1-Apr-30-Jun)	140 X 100% X (91/365)				34.91

The Transmission Charges shall be payable on monthly basis as computed above.

1.2 Computation of Monthly Transmission Charges

The Monthly Transmission Charges for any month m in a Contract Year n shall be calculated as below:

For AC System:

- a. If Actual Transmission System Availability for the month m of contract year n is greater than or equal to 98% and less than or equal to 98.5%;

$$\text{Monthly Transmission Charges MTC}(m) = T_{mn} * 1$$

- a. If Actual Transmission System Availability for the month m of contract year n exceeds 98.5% and less than or equal to 99.75%;

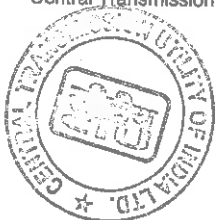

Transmission Service Agreement

Monthly Transmission Charges $MTC(m) = Tmn * (AA / 98.5\%)$

- c. If Actual Transmission System Availability for the month m of contract year n is greater than 99.75%;

Monthly Transmission Charges $MTC(m) = Tmn * (99.75\% / 98.5\%)$

- d. If Actual Transmission System Availability for the month m of contract year n is less than 98% and greater than or equal to 95.00%;

Monthly Transmission Charges $MTC(m) = Tmn * (AA / 98\%)$

- e. If Actual Transmission System Availability for the month m of contract year falls below 95%;

Monthly Transmission Charges $MTC(m) = Tmn * (AA / 98\%) - 0.02 * (Tmn * (AA / 95\%))$

For DC System:

- a. If Actual Transmission System Availability for the month m of contract year n is greater than or equal to 95% and less than or equal to 96%;

Monthly Transmission Charges $MTC(m) = Tmn * 1$

- b. If Actual Transmission System Availability for the month m of contract year n exceeds 96% and less than or equal to 99.75%;

Monthly Transmission Charges $MTC(m) = Tmn * (AA / 96\%)$

- c. If Actual Transmission System Availability for the month m of contract year n is greater than 99.75%;

Monthly Transmission Charges $MTC(m) = Tmn * (99.75\% / 96\%)$

- d. If Actual Transmission System Availability for the month m of contract year n is less than 95% and greater than or equal to 92.00%;

Monthly Transmission Charges $MTC(m) = Tmn * (AA / 95\%)$

- e. If Actual Transmission System Availability for the month m of contract year falls below 92%;

Monthly Transmission Charges $MTC(m) = Tmn * (AA / 95\%) - 0.02 * (Tmn * (AA / 92\%))$

where:

- AA is the actual Availability, as certified by RPC, as per procedure provided in Schedule 6.
- m is the month in Contract Year 'n'
- $Tmn = \text{Transmission Charges for the month 'm' in Contract Year 'n'} = (\text{Transmission Charge} / \text{no. of days in the Year n}) * \text{no. of days in month m}$

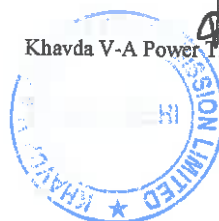

Transmission Service Agreement

Provided, no Transmission Charges shall be paid during the period for which the RLDC has not allowed the operation of the Element/Project due to the failure of the TSP to operate it as per the provisions of the Grid Code.

1.3 RLDC Fee & Charges

The payment of RLDC fee & charges, in accordance with relevant regulations of CERC, shall be the responsibility of the TSP.

Central Transmission Utility of India Limited



240

Khavda V-A Power Transmission Limited

A



295

Schedule: 5

Quoted Transmission Charges

[Quoted Transmission Charges from Annexure - 21 of the RFP of the Selected Bidder to be inserted here]

[To be incorporated from the Bid of the Selected Bidder submitted during the e-reverse auction after its selection]

Annual
Quoted Transmission Charges: Rs. 40828.67 Million

Proportionate Transmission Charges payable for each Element of the Project:

Sl. No.	Name of the Transmission Element	Percentage of Quoted Transmission Charges recoverable on Scheduled COD of the Element of the Project	Element(s) which are pre-required for declaring the commercial operation (COD) of the respective Element
1A#	Establishment of 3000 MW, \pm 800 kV KPS2 (HVDC) [LCC] terminal station (2x1500 MW) (Bipole-1) along with associated interconnections with 400 kV HVAC Switchyard*.	31.03%	All Elements (except Bipole 2 (2x1500MW)) are required to be commissioned simultaneously in 48 months as their utilization is dependent on commissioning of each other. The Bipole-2 (2x1500MW) shall be commissioned in 54 months.
2A#	Establishment of 3000 MW, \pm 800 kV Nagpur (HVDC) [LCC] terminal station (2x1500 MW) (Bipole-1) along with associated interconnections with 400 kV HVAC Switchyard*		
1B#	Establishment of 3000 MW, \pm 800 kV KPS2 (HVDC) [LCC] terminal station (2x1500 MW) (Bipole-2) along with associated interconnections with 400 kV HVAC Switchyard*.	31.03%	
2B#	Establishment of 3000 MW, \pm 800 kV Nagpur (HVDC) [LCC] terminal station (2x1500 MW) (Bipole-2) along with associated interconnections with 400 kV HVAC Switchyard*		
3.	\pm 800 kV HVDC Bipole line (Hexa lapwing) between KPS2 (HVDC) and	37.94%	

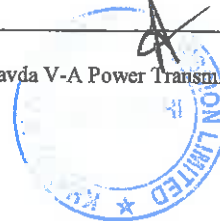
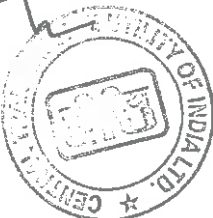

Transmission Service Agreement

Sl. No.	Name of the Transmission Element	Percentage of Quoted Transmission Charges recoverable on Scheduled COD of the Element of the Project	Element(s) which are pre-required for declaring the commercial operation (COD) of the respective Element
	Nagpur (HVDC) (1200 km) (with Dedicated Metallic Return) (capable to evacuate 6000 MW with overload as specified)		
4.	Establishment of 6x1500 MVA, 765/400 kV ICTs at Nagpur-S/s along with 2x330 MVAR (765 kV) & 2x125 MVAR, 420 kV bus reactors along with associated interconnections with HVDC Switchyard*. The 400 kV bus shall be established in 2 sections through 1 set of 400 kV bus sectionaliser so that 3x1500 MVA ICTs are placed in each section. The bus sectionaliser shall be normally closed and may be opened based on Grid requirement.		
5.	LILO of Wardha – Raipur 765 kV one D/c line (out of 2xD/c lines) at Nagpur		
6.	Installation of 240 MVAR switchable line reactor at Nagpur end on each ckt of Nagpur – Raipur 765 kV D/c line		

* The 400 kV interconnections (along with all associated equipment/ bus extension, etc.) between HVDC & HVAC switchyards shall be implemented by the TSP

#Scope w.r.t. 6000 MW, ± 800 kV HVDC [LCC] terminal station (4x1500 MW) at KPS2 & Nagpur has been split into 3000 MW, ± 800 kV HVDC [LCC] terminal station (2x1500 MW) Bipole-1 (Sl. 1A & 2A) and 3000 MW, ± 800 kV HVDC [LCC] terminal station (2x1500 MW) Bipole-2 (Sl. 1B & 2B).

Central Transmission Utility of India Limited



242

Khavda V-A Power Transmission Limited



297

Schedule: 6

Appendix –IV to Central Electricity Regulatory Commission (Terms and Conditions of Tariff) Regulations, 2024

Procedure for Calculation of Transmission System Availability Factor for a Month

1. Transmission system availability factor for nth calendar month (“TAFPn”) shall be calculated by the respective transmission licensee, verified by the concerned Regional Load Dispatch Centre (RLDC) and certified by the Member-Secretary, Regional Power Committee of the region concerned, separately for each AC and HVDC transmission system and grouped according to sharing of transmission charges. In the case of the AC system, transmission System Availability shall be calculated separately for each Regional Transmission System and inter-regional transmission system. In the case of the HVDC system, transmission System Availability shall be calculated on a consolidated basis for all inter-state HVDC systems.
2. Transmission system availability factor for nth calendar month (“TAFPn”) shall be calculated by considering the following:
 - i) **AC transmission lines:** Each circuit of AC transmission line shall be considered as one element;
 - ii) **Inter-Connecting Transformers (ICTs):** Each ICT bank (three single-phase transformers together) shall form one element;
 - iii) **Static VAR Compensator (SVC):** SVC, along with SVC transformer, shall form one element;
 - iv) **Bus Reactors or Switchable line reactors:** Each Bus Reactors or Switchable line reactors shall be considered as one element;
 - v) **HVDC Bi-pole links:** Each pole of the HVDC link, along with associated equipment at both ends, shall be considered as one element;
 - vi) **HVDC back-to-back station:** Each block of the HVDC back-to-back station shall be considered as one element. If the associated AC line (necessary for the transfer of inter-regional power through the HVDC back-to-back station) is not available, the HVDC back-to-back station block shall also be considered unavailable;
 - vii) **Static Synchronous Compensation (“STATCOM”):** Each STATCOM shall be considered as a separate element.
3. The Availability of the AC and HVDC portion of the Transmission system shall be calculated by considering each category of transmission elements as under:

Central Transmission Utility of India Limited

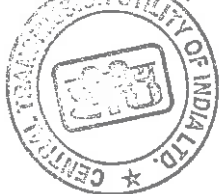

243

Khavda V-A Power Transmission Limited



298

Transmission Service Agreement

TAFPN (in %) for AC system:

$$= \frac{(o \times AV_o) + (p \times AV_p) + (q \times AV_q) + (r \times AV_r) + (u \times AV_u)}{(o + p + q + r + u)} \times 100$$

Where,

- o** = Total number of AC lines.
- AV_o** = Availability of o number of AC lines
- p** = Total number of bus reactors/switchable line reactors
- AV_p** = Availability of p number of bus reactors/switchable line reactors
- q** = Total number of ICTs
- AV_q** = Availability of q number of ICTs
- r** = Total number of SVCs
- AV_r** = Availability of r number of SVCs
- u** = Total number of STATCOM
- AV_u** = Availability of u number of STATCOM

TAFMN (in %) for HVDC System:

$$= \frac{\sum_{x=1}^s C_{xpb}(\text{act}) \times AV_{xpb} + \sum_{y=1}^t C_{ybtb}(\text{act}) \times AV_{ybtb}}{\sum_{x=1}^s C_{xpb} + \sum_{y=1}^t C_{ybtb}} \times 100$$

Where

- C_{xpb}(act)** = Total actual operated capacity of xth HVDC pole
- C_{xpb}** = Total rated capacity of xth HVDC pole
- AV_{xpb}** = Availability of xth HVDC pole
- C_{ybtb}(act)** = Total actual operated capacity of yth HVDC back-to-back station block
- C_{ybtb}** = Total rated capacity of yth HVDC back-to-back station block
- AV_{ybtb}** = Availability of yth HVDC back-to-back station block
- s** = Total no of HVDC poles
- t** = Total no of HVDC Back to Back blocks

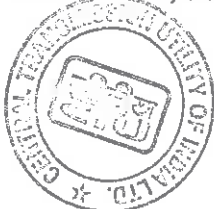

Transmission Service Agreement

4. The availability for each category of transmission elements shall be calculated based on the weightage factor, total hours under consideration and non-available hours for each element of that category. The formulae for calculation of the Availability of each category of the transmission elements are as per **Appendix-V**. The weightage factor for each category of transmission elements shall be considered as under:

- (a) For each circuit of the AC line – The number of sub-conductors in the line multiplied by ckt-km;
- (b) For each HVDC pole- The rated MW capacity x ckt-km;
- (c) For each ICT bank – The rated MVA capacity;
- (d) For SVC- The rated MVAR capacity (inductive and capacitive);
- (e) For Bus Reactor/switchable line reactors – The rated MVAR capacity;
- (f) For HVDC back-to-back stations connecting two Regional grids- Rated MW capacity of each block; and
- (g) For STATCOM – Total rated MVAR Capacity.

5. The transmission elements under outage due to the following reasons shall be deemed to be available:

- i. Shut down availed for maintenance of another transmission scheme or construction of new element or renovation/upgradation/additional capitalization in an existing system approved by the Commission. If the other transmission scheme belongs to the transmission licensee, the Member Secretary, RPC may restrict the deemed availability period to that considered reasonable by him for the work involved. In case of a dispute regarding deemed availability, the matter may be referred to the Chairperson, CEA, within 30 days.
- ii. Switching off of a transmission line to restrict over-voltage and manual tripping of switched reactors as per the directions of the concerned RLDC.
- iii. Shut down of a transmission line due to the Project(s) of NHAI, Railways and Border Road Organization, including for shifting or modification of such transmission line or any other infrastructure project approved by Ministry of Power. Member Secretary, RPC may restrict the deemed availability period to that considered reasonable by him for the work involved; Provided that apart from the deemed availability, any other costs involved in the process of such shutdown of transmission line shall not be borne by the DICs.

Provided that such deemed availability shall be considered only for the period for which DICs are not affected by the shutdown of such transmission line.

6. For the following contingencies, the outage period of transmission elements, as certified by the Member Secretary, RPC, shall be excluded from the total time of the element under the period of consideration for the following contingencies:

- i) Outage of elements due to force majeure events beyond the control of the transmission licensee. However, whether the same outage is due to force majeure (not design failure) will be verified by the Member Secretary, RPC. A reasonable restoration time for the element shall be considered by the Member Secretary, RPC, and any additional time taken by the transmission licensee for restoration of

Central Transmission Utility of India Limited



245

Khavda V-A Power Transmission Limited



300

Transmission Service Agreement

the element beyond the reasonable time shall be treated as outage time attributable to the transmission licensee. Member Secretary, RPC may consult the transmission licensee or any expert for estimation of reasonable restoration time. Circuits restored through ERS (Emergency Restoration System) shall be considered as available;

- ii) Outage caused by grid incident/disturbance not attributable to the transmission licensee, e.g. faults in a substation or bays owned by another agency causing an outage of the transmission licensee's elements, and tripping of lines, ICTs, HVDC, etc., due to grid disturbance. However, if the element is not restored on receipt of direction from RLDC while normalizing the system following grid incident/disturbance within reasonable time, the element will be considered not available for the period of outage after issuance of RLDC's direction for restoration;
 - iii) The outage period which can be excluded for the purpose of sub-clause (i) and (ii) of this clause shall be declared as under:
 - a. Maximum up to one month by the Member Secretary, RPC;
 - b. Beyond one month and up to three months after the decision at RPC;
 - c. Beyond three months by the Commission for which the transmission license shall approach the Commission along with reasons and steps taken to mitigate the outage and restoration timeline.
7. Time frame for certification of transmission system availability: (1) The following schedule shall be followed for certification of availability by the Member Secretary of the concerned RPC:
- Submission of outage data along with documentary proof (if any) and TAFPn calculation by Transmission Licensees to RLDC/ constituents
 - By the 5th of the following month;
 - Review of the outage data by RLDC / constituents and forward the same to respective RPC
 - by 20th of the month;
 - Issue of availability certificate by respective RPC – by the 3rd of the next month.

Central Transmission Utility of India Limited

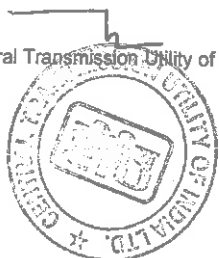

246

Khavda V-A Power Transmission Limited



201

Appendix-V

FORMULAE FOR CALCULATION OF AVAILABILITY OF EACH CATEGORY OF TRANSMISSION ELEMENTS

For AC transmission system

$$AV_o(\text{Availability of } o \text{ no. of AC lines}) = \frac{\sum_{k=1}^o W_k(T_k - TNA_k)T_k}{\sum_{k=1}^o W_k}$$

$$AV_q(\text{Availability of } q \text{ no. of ICTs}) = \frac{\sum_{k=1}^q W_k(T_k - TNA_k)T_k}{\sum_{k=1}^q W_k}$$

$$AV_r(\text{Availability of } r \text{ no. of SVCs}) = \frac{\sum_{k=1}^{r-1} W_k(T_k - TNA_k)T_k}{\sum_{k=1}^r W_k}$$

$$AV_p(\text{Availability of } p \text{ no. of Switched Bus reactors}) = \frac{\sum_{m=1}^p W_m(T_m - TNA_m)T_m}{\sum_{m=1}^p W_m}$$

$$AV_u(\text{Availability of } u \text{ no. of STATCOMs}) = \frac{\sum_{n=1}^u W_n(T_n - TNA_n)T_n}{\sum_{n=1}^u W_n}$$

$$AV_{xtp}(\text{Availability of an individual HVDC pole}) = \frac{(T_x - TN)}{T_x}$$

AV_{ytp} (Availability of an individual HVDC

$$\text{Back-to-back Blocks}) = \frac{(T_y - TNA_y)}{T_y}$$

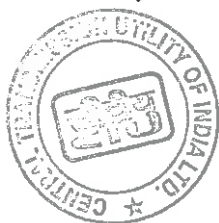

302

Transmission Service Agreement

For the HVDC transmission system

For the new HVDC commissioned but not completed twelve months:

For first 12 months: $[(AV_{xtp} \text{ or } AV_{ytb}) \times 95\% \text{ or } 85\%]$, subject to a ceiling of 95%.

Where,

o	=	Total number of AC lines;
AV_o	=	Availability of o number of AC lines;
p	=	Total number of bus reactors/switchable line reactors;
AV_p	=	Availability of p number of bus reactors/switchable line reactors;
q	=	Total number of ICTs;
AV_q	=	Availability of q number of ICTs;
r	=	Total number of SVCs;
AV_r	=	Availability of r number of SVCs;
U	=	Total number of STATCOM;
AV_u	=	Availability of u number of STATCOMs;
W_i	=	Weightage factor for i th transmission line;
W_k	=	Weightage factor for k th ICT;
W_l	=	Weightage factors for inductive & capacitive operation of l th SVC;
W_m	=	Weightage factor for m th bus reactor;
W_n	=	Weightage factor for n th STATCOM.
$T_i, T_k, T_l, T_m, T_n, T_x, T_y$	=	The total hours of i th AC line, k th ICT, l th SVC, m th Switched Bus Reactor & n th STATCOM, x th HVDC pole, y th HVDC back-to-back blocks during the period under consideration (excluding time period for outages not attributed to transmission licensee for the reasons given in Para 5 of the procedure)
T_{xal}, T_{xat}	=	The non-availability hours (excluding the time period for outages not attributed to transmission licensee taken as deemed availability as $T_{xal}, T_{xar}, T_{xax}, T_{xay}$ per Para 5 of the procedure) for i th AC line, k th ICT, l th SVC, m th Switched Bus Reactor, n th STATCOM, x th HVDC pole and y th HVDC back-to-back block.

Central Transmission Utility of India Limited

248

Khavda V-A Power Transmission Limited



283

Transmission Service Agreement

Schedule: 7

Entire Bid (both financial bid and technical bid) of the Selected Bidder to be attached here

Central Transmission Utility of India Limited



249

Khavda V-A Power Transmission Limited

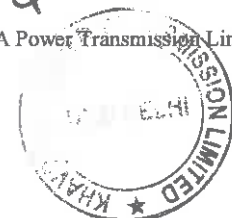

304

Schedule: 8

Contract Performance Guarantee

(To be on non-judicial stamp paper of appropriate value as per Stamp Act relevant to place of execution. Foreign entities submitting Bids are required to follow the applicable law in their country.)

In consideration of the[Insert name of the SPV or Selected Bidder on behalf of the TSP, or Lead Member in case of the Consortium, with address] agreeing to undertake the obligations under the Transmission Service Agreement datedand the other RFP Project Documents and the Nodal Agency and the[Insert the name of the BPC], agreeing to execute the *RFP Project Documents* with the Selected Bidder, regarding setting up the Project, the [Insert name and address of the bank issuing the guarantee and address of the head office] (hereinafter referred to as "Guarantor Bank") hereby agrees unequivocally, irrevocably and unconditionally to pay to (being the Nodal Agency) at[Insert the Place from the address of the Nodal Agency indicated in the TSA] forthwith on demand in writing from the Nodal Agency or any Officer authorized by it in this behalf, any amount up to and not exceeding Rupees Crores (Rs.) only [Insert the amount of the bank guarantee] on behalf of M/s. [Insert name of the Selected Bidder or SPV].

This guarantee shall be valid and binding on the Guarantor Bank up to and includingand shall not be terminable by notice or any change in the constitution of the Bank or the term of the Transmission Service Agreement or by any other reasons whatsoever and our liability hereunder shall not be impaired or discharged by any extension of time or variations or alternations made, given, or agreed with or without our knowledge or consent, by or between parties to the respective agreement.

Our liability under this Guarantee is restricted to Rs. Crores (Rs.) only. Our Guarantee shall remain in force until [Insert the date of validity of the Guarantee as per Article 3.1.2 of this Agreement]. The Nodal Agency, shall be entitled to invoke this Guarantee up to three hundred sixty five (365) days of the last date of the validity of this Guarantee.

The Guarantor Bank hereby expressly agrees that it shall not require any proof in addition to the written demand from (in its roles as the Nodal Agency), made in any format, raised at the above-mentioned address of the Guarantor Bank, in order to make the said payment to Nodal Agency.

Central Transmission Utility of India Limited



250

Khavda V-A Power Transmission Limited

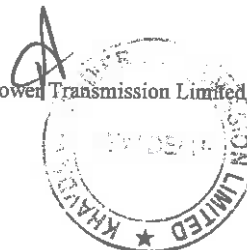
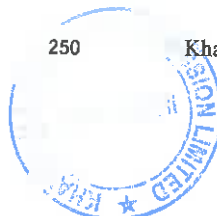

305

Transmission Service Agreement

The Guarantor Bank shall make payment hereunder on first demand without restriction or conditions and notwithstanding any objection by [Insert name of the Selected Bidder], [Insert name of the TSP] and / or any other person. The Guarantor Bank shall not require Nodal Agency to justify the invocation of this BANK GUARANTEE, nor shall the Guarantor Bank have any recourse against Nodal Agency in respect of any payment made hereunder.

THIS BANK GUARANTEE shall be interpreted in accordance with the laws of India.

The Guarantor Bank represents that this BANK GUARANTEE has been established in such form and with such content that it is fully enforceable in accordance with its terms as against the Guarantor Bank in the manner provided herein.

THIS BANK GUARANTEE shall not be affected in any manner by reason of merger, amalgamation, restructuring, liquidation, winding up, dissolution or any other change in the constitution of the Guarantor Bank.

THIS BANK GUARANTEE shall be a primary obligation of the Guarantor Bank and accordingly Nodal Agency shall not be obliged before enforcing this BANK GUARANTEE to take any action in any court or arbitral proceedings against [Insert name of the SPV] or the Selected Bidder, as the case may be, to make any claim against or any demand on [Insert name of the SPV] or the Selected Bidder, as the case may be, or to give any notice to [Insert name of the SPV] or the Selected Bidder, as the case may be, or to enforce any security held by the Nodal Agency or to exercise, levy or enforce any distress, diligence or other process against [Insert name of the SPV] or the Selected Bidder, as the case may be.

The Guarantor Bank acknowledges that this BANK GUARANTEE is not personal to Nodal Agency and may be assigned, in whole or in part, (whether absolutely or by way of security) by Nodal Agency to any entity to whom the Nodal Agency is entitled to assign its rights and obligations under the Transmission Service Agreement.

The Guarantor Bank hereby agrees and acknowledges that Nodal Agency shall have a right to invoke this Bank Guarantee either in part or in full, as it may deem fit.

Notwithstanding anything contained hereinabove, our liability under this Guarantee is restricted to Rs. Crores (Rs.) only and it shall remain in force until [Date to be inserted on the basis of Article 3.1.2 of the Transmission Service Agreement], with an additional claim period of three hundred sixty five (365) days thereafter. This BANK GUARANTEE shall be extended from time to time for such period, as may be desired by [Insert name of the Selected Bidder or Lead Member in case of the Consortium or SPV]. We are liable to pay the guaranteed amount or any part thereof under this Bank Guarantee only if Nodal Agency serves upon us a written claim or demand.

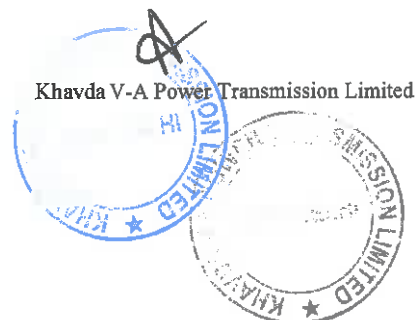
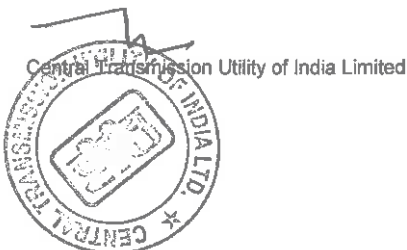

306

Transmission Service Agreement

In witness where of:

Signature

Name:

Power of attorney No.:

For:

..... [Insert Name of the Bank]

Banker's Seal and Full Address, including mailing address of the Head Office

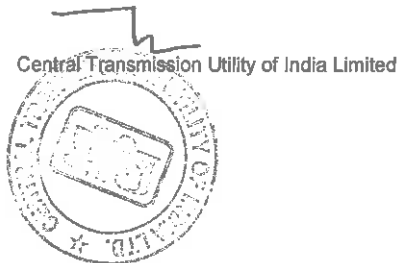

252

307



Schedule: 9

Methodology for determining the Relief Under Force Majeure Event & Change in Law during Construction Period

The relief in the form of revision in tariff due to Force Majeure Event leading to extension of Scheduled COD for a period beyond one hundred eighty (180) days and/ or Change in Law during the construction period shall be as under:

$$\Delta T = [(P \times d)] \div [1 - (1 + d)^{-n}]$$

Where,

ΔT = Change in Transmission Charges for each year

P = Sum of cumulative increase or decrease in the cost of the Project due to Change in Law and interest cost during construction corresponding to the period exceeding one hundred eighty (180) due to Force Majeure Event leading to extension of Scheduled COD for a period beyond one hundred eighty (180) days

n = number of years over which the Transmission Charges has to be paid

d = Discount rate as notified by the CERC, applicable on the Bid Deadline

The increase in Transmission Charges as stated above shall be applicable only if the value of increase in Transmission Charges as calculated above exceeds 0.30% (zero point three percent) of the quoted Transmission Charges of the TSP.

Central Transmission Utility of India Limited

253



Khavda V-A Power Transmission Limited



308

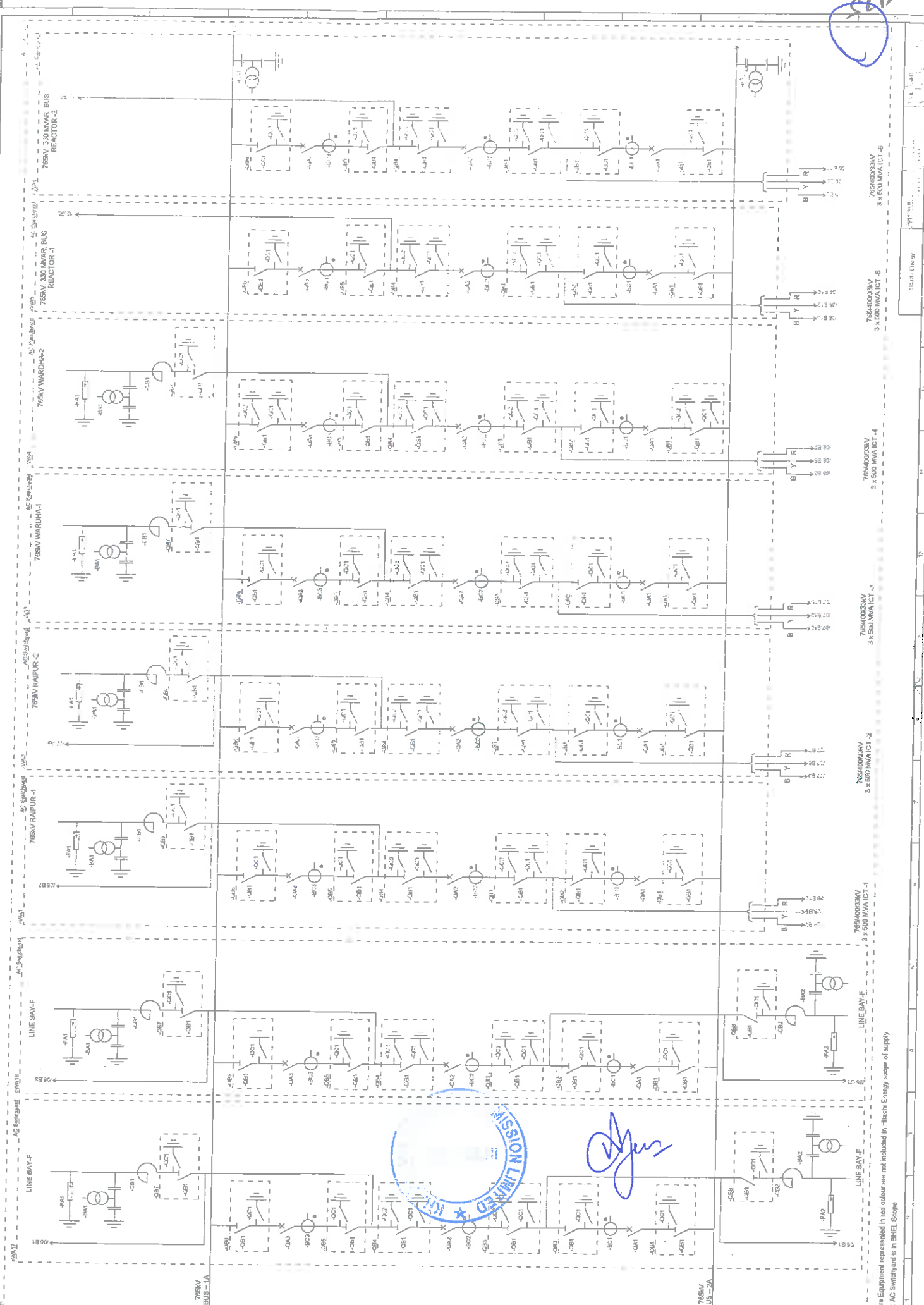

310



MISSION LIMITED

[Handwritten Signature]

209

Note: AC Switchgear is in BHTEL Scope
 Figure Equipment represented in red colour are not included in Hitech Energy scope of supply

1. Particulars of the Applicant

Sl No	Particulars	Particulars
I	Name of the Applicant	KHAVDA V-A POWER TRANSMISSION LIMITED
II	Status	Public Limited Company
III	Address	B-9, Qutab Institutional Area, Katwaria Sarai, New Delhi 110 016
IV	Name, Designation & Address of the contact person	Shri Amit Kumar Jain Finance Incharge, KHAVDA V-A POWER TRANSMISSION LIMITED (100% wholly owned subsidiary of Power Grid Corporation of India Limited) C/o Shri Pankaj Pandey ED (TBCB) Power Grid Corporation of India Limited Saudamini, Plot no.2, Sector -29, Gurgaon 122001
V	Contact Tele. No.	Shri Amit Kumar Jain - 9971492658 Shri Pankaj Pandey - 9910378037
VI	Fax No.	0124-2822062
VII	Email ID	tbcb@powergrid.in
VIII	Place of Incorporation / Registration	New Delhi, India
IX	Year of Incorporation / Registration	2023
X	Copies of the following documents are enclosed:	
a.	Certificate of Registration	Enclosed as Enclosure 1
b.	Copy of Power of Attorney	Enclosed as Enclosure 3

2. Particulars of the Project:

(a) Transmission lines

S.No	Name (end points location)	Voltage class (kV)	Length# (km)	Type (S/C or D/C)
1.	±800 kV HVDC Bipole line (Hexa lapwing) between KPS2 (HVDC) and Nagpur (HVDC) (with Dedicated Metallic Return) (capable to evacuate 6000 MW with overload as specified)	±800 kV HVDC	1206.149 km	Bipole
2.	LILO of Wardha – Raipur 765 kV one D/c line (out of 2xD/c lines) at Nagpur	765kV	LILO In- 18.861 km LILO Out- 19.086 km	D/C

As per the survey report furnished by BPC



Amit

310

(b) Sub-stations :

S.No	Name of substation	Voltage Level	Transformer	Reactive Compensation	STATCOM	No of bays
1.	±800 KV HVDC [LCC] terminal station (4x1500 MW) at KPS2	±800 KV	4x1500 MW (±800/±400 kV Converter Transformer)			Bipole-1 (2x1500MW) on Bus Section-1 Bipole-2 (2x1500MW) on Bus Section-2
2.	±800 KV HVDC [LCC] terminal station (4x1500 MW) at Nagpur	±800 KV	4x1500 MW (±800/±400 kV Converter Transformer)			Bipole-1 (2x1500MW) on Bus Section-1 Bipole-2 (2x1500MW) on Bus Section-2
3.	765/400 kV Nagpur (HVAC) Substation	765kV	6x1500MVA, (765/400kV ICTs)	765kV, 330MVar (Bus Reactor) – 2 nos. 765kV, 240MVar (Switchable line reactor) – 2 nos.		765 kV ICT bays- 6 Nos. 765 kV reactor bay- 2 Nos. 765 kV line bay- 4 Nos. 765 kV switchable line reactors- 2 Nos.
4.	765/400 kV Nagpur (HVAC) Substation	400kV		420kV, 125MVar (Bus Reactor) – 2 nos.		400 kV ICT bays- 6 Nos. (3 on each section) 400 kV reactor bay- 2 Nos. (one on each section) 400 kV Bus sectionaliser - 1 Set

- a) Remarks: Application is being filed for grant of a fresh license
b) Scheduled COD: 48 months for Bipole-1 (2x1500 MW) and all other elements except Bipole 2 (2x1500MW) and 54 months for Bipole-2 (2x1500 MW) (from date of SPV acquisition i.e., 19.11.2024).
c) Ageements with CTU (Nodal Agency) for the Project: Transmission Service Agreement (TSA) is enclosed as Annexure-6 to the application



3. Quoted transmission charges : Rs. 40828.67 millions per annum

4. (a) Approval of Central Government as per Electricity (Transmission System Planning, Development and Recovery of Inter-state Transmission Charges) Rules, 2021 } Copy of Gazettee notification is enclosed as Annexure-1 to the application

(b) Evaluation report (if made public) by the Bid Process Coordinator } Certificate of Bid Evaluation Committee as furnished by BPC is enclosed as Enclosure-2

5. List of documents enclosed:

- a) Certificate of Registration, MoA & AoA: Enclosure-1
- b) Certificate of Bid Evaluation Committee as furnished by BPC: Enclosure-2
- c) Copy of Power of Attorney: Enclosure-3

Date: 19/11/2024
Place: New Delhi

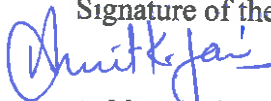
Signature of the Applicant

Represented by Amit Kumar Jain



1. अर्जदाराचा तपशील

अनु क्रमांक	विशेष	विशेष
I	अर्जदाराचे नाव	खावडा V-A पॉवर ट्रान्समिशन लिमिटेड
II	स्थान	पब्लिक लिमिटेड कंपनी
III	पत्ता	बी-9, कुतब इंस्टिटयुशनल एरिया, कटवारिया सराई, नवी दिल्ली-110 016
IV	संपर्क व्यक्तीचे नाव, पद आणि पत्ता	श्री अमित कुमार जैन वित्त प्रभारी, खावडा V-A पॉवर ट्रान्समिशन लिमिटेड (पॉवर ग्रीड कॉर्पोरेशन ऑफ इंडिया लिमिटेडची १००% पूर्ण मालकीची उपकंपनी) C/o श्री पंकज पांडेय ईडी (टीबीसीबी) पॉवर ग्रीड कॉर्पोरेशन ऑफ इंडिया लि. सौदामिनी, प्लॉट नंबर 2, सेक्टर-29, गुडगाव 122001
V	संपर्क दूरध्वनी क्रमांक	अमित कुमार जैन - 9971492658 श्री पंकज पांडे - 9910378037
VI	फॅक्स क्र.	0124-2822062
VII	ईमेल आयडी	tbcb@powergrid.in
VIII	समाविष्ट करण्याचे ठिकाण / नोंदणी	नवी दिल्ली, भारत
IX	समावेश / नोंदणीचे वर्ष	2023
X	खालील कागदपत्रांच्या प्रती संलग्न आहेत:	
a.	नोंदणी प्रमाणपत्र	एन्क्लोजर 1 म्हणून संलग्न
b.	पॉवर ऑफ अ‍ॅटर्नीची प्रत	एन्क्लोजर 3 म्हणून संलग्न

2. प्रकल्पाचा तपशील :

(a) पारेषण वाहिन्या

S.No	नाव (अंतिम बिंदू स्थान)	व्होल्टेज वर्ग (केव्ही)	लांबी# (किमी)	प्रकार (एस / सी किंवा डी / सी)
1.	केपीएस 2 (एचव्हीडीसी) आणि नागपूर (एचव्हीडीसी) दरम्यान ±800 केव्ही एचव्हीडीसी बायपोल लाइन (हेक्सा लॅपविंग) (डेडिकेटेड मेटॅलिक रिटर्नसह) (निर्दिष्ट केल्याप्रमाणे)	±800 केव्ही एचव्हीडीसी	1206.149 कि.मी.	Bipole



Agar

	ओव्हरलोडसह 6000 मेगावॉट रिकामी करण्यास सक्षम)			
2.	वर्धा - रायपूर येथील लिलो ७६५ केव्ही वन डी/सी लाइन (२एक्सडी/सी लाइनपैकी) नागपूर येथे	765 केव्ही	लिलो इन- 18.861 किमी लिलो आऊट- 19.086 किमी	D/C

बीपीसीने सादर केलेल्या सर्वेक्षण अहवालानुसार

(b) उपकेंद्रे :

S.No	सबस्टेशनचे नाव	व्होल्टेज पातळी	ट्रान्सफॉर्म करा	प्रतिक्रियात्मक नुकसान भरपाई	STATC OM	खाडींची संख्या
1.	केपीएस 2 येथे ±800 केव्ही एचव्हीडीसी [एलसीसी] टर्मिनल स्टेशन (4x1500 मेगावॉट)	±800 केव्ही	4x1500 मेगावॉट (±800/±400 केव्ही कन्व्हर्टर ट्रान्सफॉर्मर)			बस सेक्शन-१ वर बायपोल-१ (२x१५०० मेगावॉट) बस सेक्शन-२ वर बायपोल-२ (२x१५०० मेगावॉट)
2.	नागपूर येथे ±८०० केव्ही एचव्हीडीसी टर्मिनल स्टेशन (४ बाय १५०० मेगावॉट)	±800 केव्ही	4x1500 मेगावॉट (±800/±400 केव्ही कन्व्हर्टर ट्रान्सफॉर्मर)			बस सेक्शन-१ वर बायपोल-१ (२x१५०० मेगावॉट) बस सेक्शन-२ वर बायपोल-२ (२x१५०० मेगावॉट)
3.	765/400 केव्ही नागपूर (एचव्हीएसी) सबस्टेशन	765 केव्ही	6x1500 एमव्हीए, (765/400 केव्ही आयसीटी)	765 केव्ही, 330 एमव्हीएआर (बस रिअॅक्टर) - 2 नंबर. 765 केव्ही, 240 एमव्हीएआर (स्विचेबल लाइन रिअॅक्टर) - 2 नंबर.		७६५ केव्ही आयसीटी खाडी- ६ क्र. ७६५ केव्ही रिअॅक्टर बे- २ क्र. ७६५ केव्ही लाइन खाडी- ४ क्र. ७६५ केव्ही स्विचेबल लाइन रिअॅक्टर बे- २ क्र.
4.	765/400 केव्ही नागपूर (एचव्हीएसी) सबस्टेशन	400 केव्ही		420 केव्ही, 125 एमव्हीएआर (बस रिअॅक्टर) - 2 नंबर.		४०० केव्ही आयसीटी खाडी- ६ क्रमांक (प्रत्येक विभागावर ३) ४०० केव्ही रिअॅक्टर खाडी- २ क्रमांक (प्रत्येक विभागावर एक) 400 केव्ही बस सेक्शनलायझर - 1 सेट

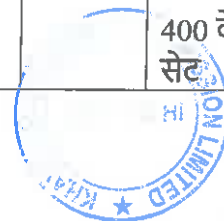

Signature

- a) टिप्पणी : नवीन परवाना देण्यासाठी अर्ज दाखल केला जात आहे
- b) शेड्यूल्ड सीओडी : बायपोल-१ (२x१५०० मेगावॉट) आणि बायपोल-२ (२x१५०० मेगावॉट) वगळता इतर सर्व घटकांसाठी ४८ महिने आणि बायपोल-२ (२x१५०० मेगावॉट) साठी ५४ महिने (प्रभावी तारखेपासून म्हणजे १९.११.२०२४).
- c) प्रकल्पासाठी सीटीयू (नोडल एजन्सी) शी करार: ट्रान्समिशन सर्व्हिस अॅग्रीमेंट (टीएसए) अर्जाच्या परिशिष्ट -6 म्हणून संलग्न आहे

3. ट्रान्समिशन चार्जेस (रु.) दशलक्ष प्रतिवर्ष: रु. 40828.67 मिलियन वार्षिक

4. (अ) विद्युत (पारेषण प्रणाली नियोजन, विकास व आंतरराज्य पारेषण शुल्काची वसुली) नियम, २०२१ नुसार केंद्र सरकारची मान्यता } राजपत्रित अधिसूचनेची प्रत अर्जाला परिशिष्ट-१ म्हणून संलग्न केली आहे

- (ब) निविदा प्रक्रिया समन्वयकाद्वारे मूल्यमापन अहवाल (सार्वजनिक केल्यास) } बीपीसीने सादर केलेले निविदा मूल्यमापन समितीचे प्रमाणपत्र एन्क्लोजर-२ म्हणून संलग्न आहे

5. संलग्न कागदपत्रांची यादी :

- a) नोंदणी प्रमाणपत्र, एमओए आणि एओए: एन्क्लोजर-1
- ब) बीपीसीने सादर केलेले निविदा मूल्यमापन समितीचे प्रमाणपत्र : एन्क्लोजर-२
- क) पॉवर ऑफ अॅटर्नीची प्रत : एन्क्लोजर-३

तारीख: 19/11/2024
स्थळ : नवी दिल्ली

अर्जदाराची स्वाक्षरी

अमित कुमार जैन



૧. અરજદાર ની વિગત :

ક્રમ	વિગત	વિગત
I	અરજદાર નું નામ	ખાવડા વી-એ પાવર ટ્રાન્સમિશન લિમિટેડ
II	હોદ્દો	જાહેર નિમિત કંપની
III	સરનામું	બી-૯, કુતાબ ઇન્સ્ટીટ્યુશન એરિયા, કત્વરિયા સરાઈ, નવી દિલ્હી-૧૧૦૦૧૬
IV	સંપર્ક કરનાર વ્યક્તિ નું નામ, સરનામું અને હોદ્દો	શ્રી અમિતકુમાર જૈન ફાયનાન્સ ઈન્ચાર્જ, ખાવડા વી-એ પાવર ટ્રાન્સમિશન લિમિટેડ (પાવર િડ કોર્પોરેશન ઓફ ઈન્ડિયા લિમિટેડની ૧૦૦% સંપૂર્ણ માલિકીની પેટાકંપની) C/o શ્રી પંકજ પાંડે ED (TBCB) પાવર િડ કોર્પોરેશન ઓફ ઈન્ડિયા લિમિટેડ સૌદામિની, પ્લોટ નં.2, સેક્ટર-૨૯, ગુડગાંવ ૧૨૨૦૦૧
V	સંપર્ક નંબર	શ્રી અમિતકુમાર જૈન - 9971492658 શ્રી પંકજ પાંડે - 9910378037
VI	ફેક્સ નંબર	૦૧૨૪-૨૮૨૨૦૬૨
VII	ઈ-મેલ આઈ.ડી.	tbcob@powergrid.in
VIII	નિગમ / નોંધણી નું સ્થળ	નવી દિલ્હી, ભારત
IX	નિગમ / નોંધણી નું વર્ષ	2023
X	નીચે મુજબ ના આધારો સામેલ રાખેલ છે.	
a.	નોંધની નું પ્રમાણપત્ર	બીડાણ ૧ મુજબ
b.	પાવર ઓફ એટોરની ની નકલ	બીડાણ ૩ મુજબ



(Signature)

૨. પ્રોજેક્ટ ની વિગત :

(a) પરિવહન લીટીઓ

S.No	નામ (અંતિમ બિંદુઓનું સ્થાન)	વોલ્ટેજ વર્ગ (કે.વી.)	લંબાઈ # (કિ.મી.)	પ્રકાર (S/C અથવા D/C)
1.	±800 કેવી એયવીડીસી બાયપોલ લાઇન (હેક્સા લેપવિંગ) કેપીએસ2 (એયવીડીસી) અને નાગપુર (એયવીડીસી) વચ્ચે (સમર્પિત મેટાલિક રિટર્ન સાથે) (નિર્ધારિત કર્યા મુજબ ઓવરલોડ સાથે 6000 મેગાવોટને ખાલી કરવામાં સક્ષમ)	±800 kV HVDC	1206.149 કિ.મી.	બાયપોલ
2.	નાગપુર ખાતે વર્ધાની LILo - રાયપુર 765 kV D/c લાઇન (2x D/c લાઇનમાંથી એક)	765kV	LILo In- 18.861 કિ.મી. LILo Out- 19.086 કિ.મી.	D/C

બી.પી.સી. દ્વારા રજૂ કરવામાં આવેલા સર્વે અહેવાલ મુજબ

(b) સબ-સ્ટેશન્સ :

S.No	સબસ્ટેશનનું નામ	વોલ્ટેજ સ્તર	રૂપાંતરણ કરો	પ્રત્યાઘાતી વળતર	સ્ટેટકોમ	ખાડીઓની કોઈ નથી
1.	±800 કેવી એયવીડીસી [LCC] ટર્મિનલ સ્ટેશન (4x1500 મેગાવોટ) કેપીએસ2 ખાતે	±800 KV	4x1500 MW (±800/±400 કેવી કન્વર્ટર ટ્રાન્સફોર્મર)			બસ વિભાગ- 1 પર બાયપોલ-1 (2x1500 મેગાવોટ) બસ વિભાગ- 2 પર બાયપોલ-2 (2x1500 મેગાવોટ)
2.	±800 કેવી એયવીડીસી [એલસીસી] ટર્મિનલ સ્ટેશન (4x1500 મેગાવોટ) નાગપુર ખાતે	±800 KV	4x1500 MW (±800/±400 કેવી કન્વર્ટર ટ્રાન્સફોર્મર)			બસ વિભાગ- 1 પર બાયપોલ-1 (2x1500 મેગાવોટ) બસ વિભાગ- 2 પર બાયપોલ-2 (2x1500 મેગાવોટ)
3.	765/400 કેવી નાગપુર (એયવીએસી) સબસ્ટેશન	765kV	6x1500MVA, (765/400kV ICTs)	765kV, 330MVA (બસ રિએક્ટર) - 2 નં.		765 કેવી આઇસીટી બેઇઝ- 6 નંબર. 765 કેવી રિએક્ટર ખાડી- 2 નં.

317



Signature

				765kV, 240MVA (સ્વિચેબલ લાઇન રિએક્ટર) - 2 નંબર.	765 કેવી લાઇન ખાડી- 4 નં. 765 કેવીની સ્વિચેબલ લાઇન રિએક્ટર ખાડીઓ- 2 નંબર.
4.	765/400 કેવી નાગપુર (એચવીએસી) સબસ્ટેશન	૪૦૦kV		420kV, 125MVA (બસ રિએક્ટર) - 2 નંગ.	400 કેવી આઇસીટી ખાડીઓ- 6 નંબર (દરેક વિભાગ પર 3) 400 કેવી રિએક્ટર ખાડી- 2 નંબર (દરેક સેક્શન પર એક) 400 kV બસ સેક્શનેલિઝર - 1 સેટ

અ) ટિપ્પણી: નવેસરથી લાઇસન્સ આપવા માટે અરજી દાખલ કરવામાં આવી રહી છે

બ) અનુસૂચિત સમાપ્ત તારીખ : બાયપોલ-1 (2x1500 મેગાવોટ) માટે 48 મહિના અને બાયપોલ 2 (2x1500 મેગાવોટ) સિવાયના અન્ય તમામ તત્ત્વો માટે 48 મહિના અને બાયપોલ-2 (2x1500 મેગાવોટ) માટે 54 મહિના (અસરકારક તારીખથી એટલે કે 19.11.2024).

સી) પ્રોજેક્ટ માટે સી.ટી.યુ. (નોડલ એજન્સી) સાથેના કરારો: ટ્રાન્સમિશન સર્વિસ એગ્રીમેન્ટ (ટી.એસ.એ.) અરજી સાથે જોડાણ-6 તરીકે જોડાયેલ છે.

૩. અવતરિત ટ્રાન્સમિશન શુલ્ક: રૂ. 40828.67 મિલિયન પ્રતિ વર્ષ

૪ (અ) વીજળી (ટ્રાન્સમિશન સિસ્ટમ પ્લાનિંગ,
ડેવલપમેન્ટ એન્ડ રિકવરી ઓફ ઇન્ટર-સ્ટેટ
ટ્રાન્સમિશન યાર્જિસ) નિયમો, ૨૦૨૧ મુજબ
કેન્દ્ર સરકારની મંજૂરી

ગ્રેડેટ નોટિફિકેશનની નકલ
અરજી સાથે પરિશિષ્ટ-1 તરીકે
જોડાયેલ છે

(બ) ભાવ ભરવાની પ્રક્રિયા સંયોજક દ્વારા
મૂલ્યાંકન અહેવાલ (જો જાહેર કરવામાં આવે તો).

બીપીસી દ્વારા આપવામાં આવેલ
બિડ મૂલ્યાંકન સમિતિનું
પ્રમાણપત્ર બિડાણ-2 તરીકે
જોડાયેલ છે

૫. સામેલ દસ્તાવેજોની સૂચિ:



Signature

- a) નોંધણીનું પ્રમાણપત્ર, MoA&AoA: બિડાણ-1 થી મૂળ અરજી
- b) બીપીસી દ્વારા આપવામાં આવેલ ભાવ ભરવાની પ્રક્રિયા મૂલ્યાંકન સમિતિનું પ્રમાણપત્ર: બિડાણ-2 થી મૂળ અરજી
- c) પાવર ઓફ એટર્નાની નકલ: બિડાણ -3

અરજદારની સહી

Amitkumar

શ્રી અમિતકુમાર

તારીખ: ૧૧/૧૧/૨૦૨૫
સ્થળ: નવી દિલ્હી



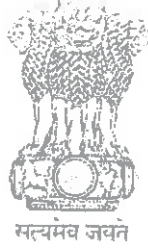

GOVERNMENT OF INDIA
MINISTRY OF CORPORATE AFFAIRS

Central Registration Centre

Certificate of Incorporation

[Pursuant to sub-section (2) of section 7 and sub-section (1) of section 8 of the Companies Act, 2013 (18 of 2013) and rule 18 of the Companies (Incorporation) Rules, 2014]

I hereby certify that KHAVDA V-A POWER TRANSMISSION LIMITED is incorporated on this TENTH day of OCTOBER TWO THOUSAND TWENTY THREE under the Companies Act, 2013 (18 of 2013) and that the company is Company limited by shares

The Corporate Identity Number of the company is **U42202DL2023GOI421022**

The Permanent Account Number (PAN) of the company is **AAKCK5613N***

The Tax Deduction and Collection Account Number (TAN) of the company is **DELK26928G***

Given under my hand at Manesar this TENTH day of OCTOBER TWO THOUSAND TWENTY THREE

Signature Not Verified

Digitally signed by
DS MINISTRY OF CORPORATE
AFFAIRS 10
Date: 2023.10.20 12:28:34 IST

Pankaj Srivastava

Assistant Registrar of Companies/ Deputy Registrar of Companies/ Registrar of Companies

For and on behalf of the Jurisdictional Registrar of Companies

Registrar of Companies

Central Registration Centre

Disclaimer: This certificate only evidences incorporation of the company on the basis of documents and declarations of the applicant(s). This certificate is neither a license nor permission to conduct business or solicit deposits or funds from public. Permission of sector regulator is necessary wherever required. Registration status and other details of the company can be verified on mca.gov.in

Mailing Address as per record available in Registrar of Companies office:

KHAVDA V-A POWER TRANSMISSION LIMITED

CORE-4, SCOPE COMPLEX, 7, LODHI ROAD, Lodi Road, Delhi, Central Delhi- 110003, Delhi

*as issued by Income tax Department

320



Form No. INC-33



Form language

English Hindi

e-MOA (e-Memorandum of Association)
[Pursuant to Schedule I (see Sections 4 and 5) to
the Companies Act, 2013]]

Refer instruction kit for filing the form

All fields marked in * are mandatory

* Table applicable to company as notified under schedule I of the Companies Act, 2013

- (A - MEMORANDUM OF ASSOCIATION OF A COMPANY LIMITED BY SHARES
- B - MEMORANDUM OF ASSOCIATION OF A COMPANY LIMITED BY GUARANTEE AND NOT HAVING A SHARE CAPITAL
- C - MEMORANDUM OF ASSOCIATION OF A COMPANY LIMITED BY GUARANTEE AND HAVING A SHARE CAPITAL
- D - MEMORANDUM OF ASSOCIATION OF AN UNLIMITED COMPANY AND NOT HAVING SHARE CAPITAL
- E - MEMORANDUM OF ASSOCIATION OF AN UNLIMITED COMPANY AND HAVING SHARE CAPITAL)

A - MEMORANDUM OF
ASSOCIATION OF A COMPANY
LIMITED BY SHARES

Table A/B/C/D/E

1 The name of the company is

KHAVDA V-A POWER
TRANSMISSION LIMITED

2 The registered office of the company will be situated in the State of

Delhi

3 (a) The objects to be pursued by the company on its incorporation are:

1. To plan, promote and develop an integrated and efficient power transmission system network in all its aspects including planning, investigation, research, design and engineering, preparation of preliminary, feasibility and definite project reports, construction, operation and maintenance of transmission lines, sub-stations, load dispatch stations and communication facilities and appurtenant works, coordination of integrated operation of regional and national grid system, execution of turn-key jobs for other utilities/organizations and wheeling of power in accordance with the policies, guidelines and objectives laid down by the Central Government from time to time.

2. To study, investigate, collect information and data, review operation, plan, research, design and prepare Report, diagnose operational difficulties and weaknesses and advise on the remedial measures to improve,

Attested from Pg 321- Pg 327
ATTESTED TRUE COPY

[Signature]
Authorized Signatory

KHAVDA V-A POWER TRANSMISSION LIMITED



undertake development of new and innovative product connected with business of the Company as well as modernize existing EHV, HV lines and Sub-Stations.

3.To act as consultants, technical advisors, surveyors and providers of technical and other services to Public or Private Sector enterprises engaged in the planning, investigation, research, design and preparations of preliminary, feasibility and definite project reports, manufacture of power plant and equipment, construction, generation, operation and maintenance of power transmission system from power generating stations and projects, transmission and distribution of power.

4.To plan, promote, develop, erect and maintain, operate and otherwise deal in Telecommunication networks and services in all its aspects including planning, investigation, research, design and engineering, preparation of preliminary, feasibility and definite project reports: to purchase, sell, import, export, assemble, manufacture, install, commission, maintain, operate commercially whether on own or along with other, on lease or otherwise. These networks and for such purposes to set up and/or install all requisite communications facilities and other facilities including fibre optic links, digital microwave links, communication cables, other telecommunication means, telephone and other exchanges, co-axial stations, microwave stations, repeater stations, security system databases, billing systems, subscriber management systems and other communication systems whether consisting of sound, visual impulse, or otherwise, existing or that may be developed or invented in the future and to manufacture, purchase, sell, import, export, assemble, take or give on lease/rental/subscription



basis or by similar means or otherwise deal in all components and other support and ancillary hardware and software systems, accessories, parts and equipments etc. used in or in connection with the operation of the above communication systems and networks including to deal with telecommunication operations or directly with the general public, commercial companies or otherwise.

1. To plan, promote and develop an integrated and efficient power transmission system network in all its aspects including planning, investigation, research, design and engineering, preparation of preliminary, feasibility and definite project reports, construction, operation and maintenance of transmission lines, sub-stations, load dispatch stations and communication facilities and appurtenant works, coordination of integrated operation of regional and national grid system, execution of turn-key jobs for other utilities/organizations and wheeling of power in accordance with the policies, guidelines and objectives laid down by the Central Government from time to time.

2. To study, investigate, collect information and data, review operation, plan, research, design and prepare Report, diagnose operational difficulties and weaknesses and advise on the remedial measures to improve, undertake development of new and innovative product connected with business of the Company as well as modernize

(b) *Matters which are necessary for furtherance of the objects specified in clause 3(a) are

1. To plan, promote and develop an integrated and efficient power transmission system network in all its aspects including planning, investigation, research, design and engineering, preparation of preliminary, feasibility and definite project reports,



construction, operation and maintenance of transmission lines, sub-stations, load dispatch stations and communication facilities and appurtenant works, coordination of integrated operation of regional and national grid system, execution of turn-key jobs for other utilities/organizations and wheeling of power in accordance with the policies, guidelines and objectives laid down by the Central Government from time to time.

2. To study, investigate, collect information and data, review operation, plan, research, design and prepare Report, diagnose operational difficulties and weaknesses and advise on the remedial measures to improve, undertake development of new and innovative product connected with business of the Company as well as modernize existing EHV, HV lines and Sub-Stations.

3. To act as consultants, technical advisors, surveyors and providers of technical and other services to Public or Private Sector enterprises engaged in the planning, investigation, research, design and preparations of preliminary, feasibility and definite project reports, manufacture of power plant and equipment, construction, generation, operation and maintenance of power transmission system from power generating stations and projects, transmission and distribution of power.

4. To plan, promote, develop, erect and maintain, operate and otherwise deal in Telecommunication networks and services in all its aspects including planning, investigation, research, design and engineering, preparation of preliminary, feasibility and definite project reports: to purchase, sell, import, export, assemble, manufacture, install, commission, maintain, operate commercially whether on own or along with other, on lease or



324

otherwise. These networks and for such purposes to set up and/or install all requisite communications facilities and other facilities including fibre optic links, digital microwave links, communication cables, other telecommunication means, telephone and other exchanges, co-axial stations, microwave stations, repeater stations, security system databases, billing systems, subscriber management systems and other communication systems whether consisting of sound, visual impulse, or otherwise, existing or that may be developed or invented in the future and to manufacture, purchase, sell, import, export, assemble, take or give on lease/rental/subscription basis or by similar means or otherwise deal in all components and other support and ancillary hardware and software systems, accessories, parts and equipments etc. used in or in connection with the operation of the above communication systems and networks including to deal with telecommunication operations or directly with the general public, commercial companies or otherwise.

4 The liability of the member(s) is limited, and this liability is limited to the amount unpaid if any, on the shares held by them.

The liability of the member(s) is limited

The liability of the member(s) is Unlimited

5 Every member of the company undertakes to contribute:

(i) to the assets of the company in the event of its being wound up while he is a member, or within one year after he ceases to be a member, for payment of the debts and liabilities of the company or of such debts and liabilities as may have been contracted before he ceases to be a member; and

(ii) to the costs, charges and expenses of winding up (and for the adjustment of the rights of the contributories among

themselves), such amount as may be required, not exceeding * _____ rupees.

(iii) The share capital of the company is 500000 rupees, divided into

50000	Equity Share	Shares of	10	Rupees each	
-------	--------------	-----------	----	-------------	--

325



We, the several persons, whose names and address are subscribed, are desirous of being formed into a company in pursuance of this memorandum of association, and we respectively agree to take the number of shares in the capital of the company set against our respective names:

I, whose name and address is given below, am desirous of forming a company in pursuance of this memorandum of association and agree to take all the shares in the capital of the company:

We, the several persons, whose names and addresses are subscribed, are desirous of being formed into a company in pursuance of this memorandum of association:

Subscriber Details					
S. No.	*Name, Address, Description and Occupation	DIN / PAN / Passport number	No. of shares taken	DSC	Dated
1	ARVIND KUMAR S/O NAND KISHOR SINGH NOMINEE OF REC POWER DEVELOPMENT AND CONSULTANCY LIMITED R/O T4-8A, SAI VATIKA APARTMENT, SECTOR-63, FARIDABAD - 121004, OCCUPATION-SERVICE	10342637	1 Equity,0 Preference	ARVIND KUMAR	06/10/2023
2	REC POWER DEVELOPMENT AND CONSULTANCY LIMITED, CORE-4, SCOPE COMPLEX, 7, LODHI ROAD, NEW DELHI-110003, THROUGH ITS CEO RAJESH KUMAR S/O SHRINIWAS GUPTA R/O L-187, NAG MANDIR KE PAS SHASTRI NAGAR, ASHOK VIHAR, DELHI-110052, OCCUPATION-SERVICES	06941428	49994 Equity,0 Preference	RAJESH KUMAR	06/10/2023
3	MOHAN LAL KUMAWAT S/O SHRI RAMU RAM KUMAWAT NOMINEE OF REC POWER DEVELOPMENT AND CONSULTANCY LIMITED FLAT NO 142 TOWER -1 GC EMERALD, RAMPRASTHA GREENS VAISHALI SECTOR-7, GHAZIABAD-201010, UTTAR PRADESH, OCCUPATION-SERVICE	07682898	1 Equity,0 Preference	Mohan Lal Kumawat	06/10/2023
4	THANGARAJAN BOSH S/O SHRI SITHAN THANGARAJAN NOMINEE OF REC POWER DEVELOPMENT AND CONSULTANCY LIMITED R/O APARTMENT NO S-2, MIDDLE PORTION 2-B, JANGPURA, MATHURA ROAD, NEW DELHI-110014, OCCUPATION-SERVICE	02772316	1 Equity,0 Preference	Thangarajan Bosh	06/10/2023



5	SAHAB NARAIN S/O HARI NARAIN NOMINEE OF REC POWER DEVELOPMENT AND CONSULTANCY LIMITED R/O A-1, FLAT NO 103, SOAMI NAGAR, MALVIYA NAGAR, DELHI-110017, OCCUPATION-SERVICE	03641879	1 Equity,0 Preference	SAHAB NARAIN	06/10/2023
6	ALOK SINGH S/O JAGDHARI SINGH NOMINEE OF REC POWER DEVELOPMENT AND CONSULTANCY LIMITED R/O MF-23, ELDECO MANSIONZ, SECTOR-48, SOHNA ROAD, GURUGRAM - 122018, OCCUPATION- SERVICE	07498786	1 Equity,0 Preference	ALOK SINGH	06/10/2023
7	PUTHIYARKATTU SHIVARAMAN HARIHARAN S/ O SHRI PUTHIYARAKAT VELAYUDHAN SIVARAMAN NOMINEE OF REC POWER DEVELOPMENT AND CONSULTANCY LIMITED FLAT NO.104, SADAR APARTMENT, MAYUR VIHAR EXTENTION, PHASE-1, PLOT NO.9, NEW DELHI-110091, OCCUPATION- SERVICE	08657652	1 Equity,0 Preference	P S HARIHAR AN	06/10/2023
Total shares taken			50000 Equity,0 Preference		

Signed before me

Membership type of the witness (ACA/FCA/ACS/FCS/ ACMA/FCMA)	*Name of the witness	*Address, Description and Occupation	DIN / PAN / Passport number / Membership number	DSC	Dated
FCA	VINAY KUMAR	1803, TOWER-9, LA RESIDENTIA, TECH ZONE-4, GREATER NOIDA WEST-201306	402996	Vinay Kumar <small>Digitally signed by Vinay Kumar Date: 2023.10.06 15:13:02 +05:30</small>	06/10/2023

7 Shri / Smt

aged

Of

resident of

years shall be the nominee in the event of death of the sole member.

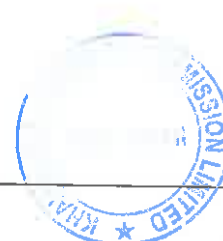

Form No. INC-34

Form language

e-AOA (e-Articles of Association)
 English Hindi

[Pursuant to Section 5 of the Companies Act, 2013
and rules made thereunder read with Schedule I]

Refer instruction kit for filing the form.

All fields marked in * are mandatory

Table applicable to company as notified under schedule I of the Companies Act, 2013
(F, G, H)

F

Table F / G / H (basis on the selection of above-mentioned field) as notified under schedule I of
the companies Act, 2013 is applicable to

(F – a company limited by shares

G – a company limited by guarantee and having a share capital

H – a company limited by guarantee and not having share capital)

F - A COMPANY LIMITED BY
SHARES

The name of the company is

KHAVDA V-A POWER
TRANSMISSION LIMITED

Check if not applicable	Check if altered	Article No.	Description
			Interpretation
<input type="checkbox"/>	<input checked="" type="checkbox"/>	I	<ul style="list-style-type: none"> (1) In these regulations- (a) the Act means the Companies Act 2013 (b) the seal means the common seal of the company. (2) Unless the context otherwise requires words or expressions contained in these regulations shall bear the same meaning as in the Act or any statutory modification thereof in force at the date at which these regulations become binding on the company. (3) Public company means a company which- (a) is not a private company (b) has a minimum paid-up share capital as may be prescribed Provided that a company which is a subsidiary of a company not being a private company shall be deemed to be public company for the purposes of this Act even where such subsidiary company continues to be a private company in its articles.
			Share Capital and Variation of rights
<input type="checkbox"/>	<input type="checkbox"/>	II 1	<ul style="list-style-type: none"> Subject to the provisions of the Act and these Articles the shares in the capital of the company shall be under the control of the Directors who may issue allot or otherwise dispose of the same or any of them to such persons in such proportion and on such terms and conditions and either at a premium or at par and at such time as they may from time to time think fit. Every person whose name is entered as a member in the register

ATTESTED TRUE COPY
Attested from Pg 328 - Pg 344
Authorized Signatory
KHAVDA V-A POWER TRANSMISSION LIMITED
328



<input type="checkbox"/>	<input checked="" type="checkbox"/>	2	<p>of members shall be entitled to receive within two months after incorporation in case of subscribers to the memorandum or after allotment or within one month after the application for the registration of transfer or transmission or within such other period as the conditions of issue shall be provided one certificate for all his shares without payment of any charges or several certificates each for one or more of his shares upon payment of twenty rupees for each certificate after the first. Every certificate shall be under the seal and shall specify the shares to which it relates and the amount paid - up thereon. In respect of any share or shares held jointly by several persons the company shall not be bound to issue more than one certificate and delivery of certificate for a share to one of several joint holders shall be sufficient delivery to all such holders.</p>
<input type="checkbox"/>	<input type="checkbox"/>	3	<ul style="list-style-type: none"> If any share certificate be worn out defaced mutilated or torn or if there be no further space on the back for endorsement of transfer then upon production and surrender thereof to the company a new certificate may be issued in lieu thereof and if any certificate is lost or destroyed then upon proof thereof to the satisfaction of the company and on execution of such indemnity as the company deem adequate a new certificate in lieu thereof shall be given. Every certificate under this Article shall be issued on payment of twenty rupees for each certificate. The provisions of Articles (2) and (3) shall mutatis mutandis apply to debentures of the company.
<input type="checkbox"/>	<input type="checkbox"/>	4	<ul style="list-style-type: none"> Except as required by law no person shall be recognised by the company as holding any share upon any trust and the company shall not be bound by or be compelled in any way to recognise (even when having notice thereof) any equitable contingent future or partial interest in any share or any interest in any fractional part of a share or (except only as by these regulations or by law otherwise provided) any other rights in respect of any share except an absolute right to the entirety thereof in the registered holder.
<input type="checkbox"/>	<input type="checkbox"/>	5	<ul style="list-style-type: none"> The company may exercise the powers of paying commissions conferred by sub-section (6) of section 40 provided that the rate per cent or the amount of the commission paid or agreed to be paid shall be disclosed in the manner required by that section and rules made thereunder. The rate or amount of the commission shall not exceed the rate or amount prescribed in rules made under sub-section (6) of section 40. The commission may be satisfied by the payment of cash or the allotment of fully or partly paid shares or partly in the one way and partly in the other.
<input type="checkbox"/>	<input type="checkbox"/>	6	<ul style="list-style-type: none"> If at any time the share capital is divided into different classes of shares the rights attached to any class (unless otherwise provided by the terms of issue of the shares of that class) may subject to the provisions of section 48 and whether or not the company is being wound up be varied with the consent in writing of the holders of three-fourths of the issued shares of that class or with the sanction of a special resolution passed at a separate meeting of the holders of the shares of that class. To every such separate meeting the provisions of these regulations relating to general meetings shall mutatis mutandis apply but so that the necessary quorum shall be at least two persons holding at least one-third of the issued shares

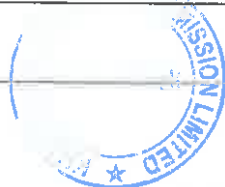

			of the class in question.
<input type="checkbox"/>	<input type="checkbox"/>	7	<ul style="list-style-type: none"> The rights conferred upon the holders of the shares of any class issued with preferred or other rights shall not unless otherwise expressly provided by the terms of issue of the shares of that class be deemed to be varied by the creation or issue of further shares ranking pari passu therewith.
<input type="checkbox"/>	<input type="checkbox"/>	8	<ul style="list-style-type: none"> Subject to the provisions of section 55 any preference shares may with the sanction of an ordinary resolution be issued on the terms that they are to be redeemed on such terms and in such manner as the company before the issue of the shares may by special resolution determine.
			Lien
<input type="checkbox"/>	<input type="checkbox"/>	9	<ul style="list-style-type: none"> The company shall have a first and paramount lien on every share (not being a fully paid share) for all monies (whether presently payable or not) called or payable at a fixed time in respect of that share and on all shares (not being fully paid shares) standing registered in the name of a single person for all monies presently payable by him or his estate to the company Provided that the Board of directors may at any time declare any share to be wholly or in part exempt from the provisions of this clause. The company's lien if any on a share shall extend to all dividends payable and bonuses declared from time to time in respect of such shares.
<input type="checkbox"/>	<input type="checkbox"/>	10	<ul style="list-style-type: none"> The company may sell in such manner as the Board thinks fit any shares on which the company has a lien Provided that no sale shall be made unless a sum in respect of which the lien exists is presently payable or b until the expiration of fourteen days after a notice in writing stating and demanding payment of such part of the amount in respect of which the lien exists as is presently payable has been given to the registered holder for the time being of the share or the person entitled thereto by reason of his death or insolvency.
<input type="checkbox"/>	<input type="checkbox"/>	11	<ul style="list-style-type: none"> To give effect to any such sale the Board may authorise some person to transfer the shares sold to the purchaser thereof The purchaser shall be registered as the holder of the shares comprised in any such transfer. The purchaser shall not be bound to see to the application of the purchase money nor shall his title to the shares be affected by any irregularity or invalidity in the proceedings in reference to the sale.
<input type="checkbox"/>	<input type="checkbox"/>	12	<ul style="list-style-type: none"> The proceeds of the sale shall be received by the company and applied in payment of such part of the amount in respect of which the lien exists as is presently payable. The residue if any shall subject to a like lien for sums not presently payable as existed upon the shares before the sale be paid to the person entitled to the shares at the date of the sale.
			Calls on shares
<input type="checkbox"/>	<input type="checkbox"/>		<ul style="list-style-type: none"> The Board may from time to time make calls upon the members in respect of any monies unpaid on their shares (whether on account

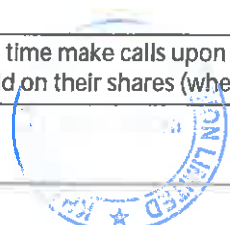

380

		13	of the nominal value of the shares or by way of premium) and not by the conditions of allotment thereof made payable at fixed times Provided that no call shall exceed one-fourth of the nominal value of the share or be payable at less than one month from the date fixed for the payment of the last preceding call. Each member shall subject to receiving at least fourteen days notice specifying the time or times and place of payment pay to the company at the time or times and place so specified the amount called on his shares. A call may be revoked or postponed at the discretion of the Board.
<input type="checkbox"/>	<input type="checkbox"/>	14	<ul style="list-style-type: none"> A call shall be deemed to have been made at the time when the resolution of the Board authorizing the call was passed and may be required to be paid by instalments.
<input type="checkbox"/>	<input type="checkbox"/>	15	<ul style="list-style-type: none"> The joint holders of a share shall be jointly and severally liable to pay all calls in respect thereof.
<input type="checkbox"/>	<input type="checkbox"/>	16	<ul style="list-style-type: none"> If a sum called in respect of a share is not paid before or on the day appointed for payment thereof the person from whom the sum is due shall pay interest thereon from the day appointed for payment thereof to the time of actual payment at ten per cent per annum or at such lower rate if any as the Board may determine. The Board shall be at liberty to waive payment of any such interest wholly or in part.
<input type="checkbox"/>	<input type="checkbox"/>	17	<ul style="list-style-type: none"> Any sum which by the terms of issue of a share becomes payable on allotment or at any fixed date whether on account of the nominal value of the share or by way of premium shall for the purposes of these regulations be deemed to be a call duly made and payable on the date on which by the terms of issue such sum becomes payable. In case of non-payment of such sum all the relevant provisions of these regulations as to payment of interest and expenses forfeiture or otherwise shall apply as if such sum had become payable by virtue of a call duly made and notified.
<input type="checkbox"/>	<input type="checkbox"/>	18	<ul style="list-style-type: none"> The Board - a. may if it thinks fit receive from any member willing to advance the same all or any part of the monies uncalled and unpaid upon any shares held by him and b. upon all or any of the monies so advanced may (until the same would but for such advance become presently payable) pay interest at such rate not exceeding unless the company in general meeting shall otherwise direct twelve per cent per annum as may be agreed upon between the Board and the member paying the sum in advance.
			Transfer of shares
<input type="checkbox"/>	<input type="checkbox"/>	19	<ul style="list-style-type: none"> The instrument of transfer of any share in the company shall be executed by or on behalf of both the transferor and transferee. The transferor shall be deemed to remain a holder of the share until the name of the transferee is entered in the register of members in respect thereof.
<input type="checkbox"/>	<input type="checkbox"/>	20	<ul style="list-style-type: none"> The Board may subject to the right of appeal conferred by section 58 decline to register the transfer of a share not being a fully paid share to a person of whom they do not approve or any transfer of



			shares on which the company has a lien.
<input type="checkbox"/>	<input type="checkbox"/>	21	<ul style="list-style-type: none"> The Board may decline to recognise any instrument of transfer unlessa. the instrument of transfer is in the form as prescribed in rules made under sub-section (1) of section 56b. the instrument of transfer is accompanied by the certificate of the shares to which it relates and such other evidence as the Board may reasonably require to show the right of the transferor to make the transfer andc. the instrument of transfer is in respect of only one class of shares.
<input type="checkbox"/>	<input type="checkbox"/>	22	<ul style="list-style-type: none"> On giving not less than seven days previous notice in accordance with section 91 and rules made thereunder the registration of transfers may be suspended at such times and for such periods as the Board may from time to time determineProvided that such registration shall not be suspended for more than thirty days at any one time or for more than forty-five days in the aggregate in any year.
			Transmission of shares
<input type="checkbox"/>	<input type="checkbox"/>	23	<ul style="list-style-type: none"> On the death of a member the survivor or survivors where the member was a joint holder and his nominee or nominees or legal representatives where he was a sole holder shall be the only persons recognised by the company as having any title to his interest in the shares Nothing in clause (i) shall release the estate of a deceased joint holder from any liability in respect of any share which had been jointly held by him with other persons.
<input type="checkbox"/>	<input type="checkbox"/>	24	<ul style="list-style-type: none"> Any person becoming entitled to a share in consequence of the death or insolvency of a member may upon such evidence being produced as may from time to time properly be required by the Board and subject as hereinafter provided elect either to be registered himself as holder of the share or to make such transfer of the share as the deceased or insolvent member could have made. The Board shall in either case have the same right to decline or suspend registration as it would have had if the deceased or insolvent member had transferred the share before his death or insolvency.
<input type="checkbox"/>	<input type="checkbox"/>	25	<ul style="list-style-type: none"> If the person so becoming entitled shall elect to be registered as holder of the share himself he shall deliver or send to the company a notice in writing signed by him stating that he so elects. If the person aforesaid shall elect to transfer the share he shall testify his election by executing a transfer of the share. All the limitations restrictions and provisions of these regulations relating to the right to transfer and the registration of transfers of shares shall be applicable to any such notice or transfer as aforesaid as if the death or insolvency of the member had not occurred and the notice or transfer were a transfer signed by that member.
<input type="checkbox"/>	<input type="checkbox"/>		<ul style="list-style-type: none"> A person becoming entitled to a share by reason of the death or insolvency of the holder shall be entitled to the same dividends and other advantages to which he would be entitled if he were the registered holder of the share except that he shall not before being registered as a member in respect of the share be entitled in



332

		26	respect of it to exercise any right conferred by membership in relation to meetings of the company Provided that the Board may at any time give notice requiring any such person to elect either to be registered himself or to transfer the share and if the notice is not complied with within ninety days the Board may thereafter withhold payment of all dividends bonuses or other monies payable in respect of the share until the requirements of the notice have been complied with.
<input checked="" type="checkbox"/>	<input type="checkbox"/>	27	<ul style="list-style-type: none"> In case of a One Person Company on the death of the sole member the person nominated by such member shall be the person recognised by the company as having title to all the shares of the member the nominee on becoming entitled to such shares in case of the members death shall be informed of such event by the Board of the company such nominee shall be entitled to the same dividends and other rights and liabilities to which such sole member of the company was entitled or liable on becoming member such nominee shall nominate any other person with the prior written consent of such person who shall in the event of the death of the member become the member of the company.
			Forfeiture of shares
<input type="checkbox"/>	<input type="checkbox"/>	28	<ul style="list-style-type: none"> If a member fails to pay any call or instalment of a call on the day appointed for payment thereof the Board may at any time thereafter during such time as any part of the call or instalment remains unpaid serve a notice on him requiring payment of so much of the call or instalment as is unpaid together with any interest which may have accrued.
<input type="checkbox"/>	<input type="checkbox"/>	29	<ul style="list-style-type: none"> The notice aforesaid shall name a further day (not being earlier than the expiry of fourteen days from the date of service of the notice) on or before which the payment required by the notice is to be made and state that in the event of non-payment on or before the day so named the shares in respect of which the call was made shall be liable to be forfeited.
<input type="checkbox"/>	<input type="checkbox"/>	30	<ul style="list-style-type: none"> If the requirements of any such notice as aforesaid are not complied with any share in respect of which the notice has been given may at any time thereafter before the payment required by the notice has been made be forfeited by a resolution of the Board to that effect.
<input type="checkbox"/>	<input type="checkbox"/>	31	<ul style="list-style-type: none"> A forfeited share may be sold or otherwise disposed of on such terms and in such manner as the Board thinks fit. At any time before a sale or disposal as aforesaid the Board may cancel the forfeiture on such terms as it thinks fit.
<input type="checkbox"/>	<input type="checkbox"/>	32	<ul style="list-style-type: none"> A person whose shares have been forfeited shall cease to be a member in respect of the forfeited shares but shall notwithstanding the forfeiture remain liable to pay to the company all monies which at the date of forfeiture were presently payable by him to the company in respect of the shares. The liability of such person shall cease if and when the company shall have received payment in full of all such monies in respect of the shares.
			<ul style="list-style-type: none"> A duly verified declaration in writing that the declarant is a director



		33	<p>the manager or the secretary of the company and that a share in the company has been duly forfeited on a date stated in the declaration shall be conclusive evidence of the facts therein stated as against all persons claiming to be entitled to the share The company may receive the consideration if any given for the share on any sale or disposal thereof and may execute a transfer of the share in favour of the person to whom the share is sold or disposed of The transferee shall thereupon be registered as the holder of the share and The transferee shall not be bound to see to the application of the purchase money if any nor shall his title to the share be affected by any irregularity or invalidity in the proceedings in reference to the forfeiture sale or disposal of the share.</p>
		34	<ul style="list-style-type: none"> The provisions of these regulations as to forfeiture shall apply in the case of non-payment of any sum which by the terms of issue of a share becomes payable at a fixed time whether on account of the nominal value of the share or by way of premium as if the same had been payable by virtue of a call duly made and notified.
			Alteration of capital
		35	<ul style="list-style-type: none"> The company may from time to time by ordinary resolution increase the share capital by such sum to be divided into shares of such amount as may be specified in the resolution.
		36	<ul style="list-style-type: none"> Subject to the provisions of section 61 the company may by ordinary resolution consolidate and divide all or any of its share capital into shares of larger amount than its existing shares convert all or any of its fully paid-up shares into stock and reconvert that stock into fully paid-up shares of any denomination sub-divide its existing shares or any of them into shares of smaller amount than is fixed by the memorandum cancel any shares which at the date of the passing of the resolution have not been taken or agreed to be taken by any person.
		37	<ul style="list-style-type: none"> Where shares are converted into stock the holders of stock may transfer the same or any part thereof in the same manner as and subject to the same regulations under which the shares from which the stock arose might before the conversion have been transferred or as near thereto as circumstances admit Provided that the Board may from time to time fix the minimum amount of stock transferable so however that such minimum shall not exceed the nominal amount of the shares from which the stock arose. the holders of stock shall according to the amount of stock held by them have the same rights privileges and advantages as regards dividends voting at meetings of the company and other matters as if they held the shares from which the stock arose but no such privilege or advantage (except participation in the dividends and profits of the company and in the assets on winding up) shall be conferred by an amount of stock which would not if existing in shares have conferred that privilege or advantage. such of the regulations of the company as are applicable to paid-up shares shall apply to stock and the words share and shareholder in those regulations shall include stock and stock-holder respectively.

334



<input type="checkbox"/>	<input type="checkbox"/>	38	<ul style="list-style-type: none"> The company may by special resolution reduce in any manner and with and subject to any incident authorised and consent required by law its share capital any capital redemption reserve account or any share premium account.
			Capitalisation of profits
<input type="checkbox"/>	<input type="checkbox"/>	39	<ul style="list-style-type: none"> The company in general meeting may upon the recommendation of the Board resolve that it is desirable to capitalise any part of the amount for the time being standing to the credit of any of the company's reserve accounts or to the credit of the profit and loss account or otherwise available for distribution and that such sum be accordingly set free for distribution in the manner specified in clause (ii) amongst the members who would have been entitled thereto if distributed by way of dividend and in the same proportions. The sum aforesaid shall not be paid in cash but shall be applied subject to the provision contained in clause (iii) either in or towards paying up any amounts for the time being unpaid on any shares held by such members respectively paying up in full unissued shares of the company to be allotted and distributed credited as fully paid-up to and amongst such members in the proportions aforesaid partly in the way specified in sub-clause (A) and partly in that specified in sub-clause (B) A securities premium account and a capital redemption reserve account may for the purposes of this regulation be applied in the paying up of unissued shares to be issued to members of the company as fully paid bonus shares The Board shall give effect to the resolution passed by the company in pursuance of this regulation.
<input type="checkbox"/>	<input type="checkbox"/>	40	<ul style="list-style-type: none"> Whenever such a resolution as aforesaid shall have been passed the Board shall make all appropriations and applications of the undivided profits resolved to be capitalised thereby and all allotments and issues of fully paid shares if any and generally do all acts and things required to give effect thereto. The Board shall have power to make such provisions by the issue of fractional certificates or by payment in cash or otherwise as it thinks fit for the case of shares becoming distributable in fractions and to authorise any person to enter on behalf of all the members entitled thereto into an agreement with the company providing for the allotment to them respectively credited as fully paid-up of any further shares to which they may be entitled upon such capitalisation or as the case may require for the payment by the company on their behalf by the application thereto of their respective proportions of profits resolved to be capitalised of the amount or any part of the amounts remaining unpaid on their existing shares Any agreement made under such authority shall be effective and binding on such members
			Buy-back of shares
<input type="checkbox"/>	<input type="checkbox"/>	41	<ul style="list-style-type: none"> Notwithstanding anything contained in these articles but subject to the provisions of sections 68 to 70 and any other applicable provision of the Act or any other law for the time being in force the company may purchase its own shares or other specified securities.

335



			General meetings
<input type="checkbox"/>	<input type="checkbox"/>	42	<ul style="list-style-type: none"> All general meetings other than annual general meeting shall be called extraordinary general meeting.
<input type="checkbox"/>	<input type="checkbox"/>	43	<ul style="list-style-type: none"> The Board may whenever it thinks fit call an extraordinary general meeting. If at any time directors capable of acting who are sufficient in number to form a quorum are not within India any director or any two members of the company may call an extraordinary general meeting in the same manner as nearly as possible as that in which such a meeting may be called by the Board.
			Proceedings at general meetings
<input type="checkbox"/>	<input type="checkbox"/>	44	<ul style="list-style-type: none"> No business shall be transacted at any general meeting unless a quorum of members is present at the time when the meeting proceeds to business. Save as otherwise provided herein the quorum for the general meetings shall be as provided in section 103.
<input type="checkbox"/>	<input type="checkbox"/>	45	<ul style="list-style-type: none"> The chairperson if any of the Board shall preside as Chairperson at every general meeting of the company.
<input type="checkbox"/>	<input type="checkbox"/>	46	<ul style="list-style-type: none"> If there is no such Chairperson or if he is not present within fifteen minutes after the time appointed for holding the meeting or is unwilling to act as chairperson of the meeting the directors present shall elect one of their members to be Chairperson of the meeting.
<input type="checkbox"/>	<input type="checkbox"/>	47	<ul style="list-style-type: none"> If at any meeting no director is willing to act as Chairperson or if no director is present within fifteen minutes after the time appointed for holding the meeting the members present shall choose one of their members to be Chairperson of the meeting.
<input checked="" type="checkbox"/>	<input type="checkbox"/>	48	<ul style="list-style-type: none"> In case of a One Person Company the resolution required to be passed at the general meetings of the company shall be deemed to have been passed if the resolution is agreed upon by the sole member and communicated to the company and entered in the minutes book maintained under section 118 such minutes book shall be signed and dated by the member the resolution shall become effective from the date of signing such minutes by the sole member.
			Adjournment of meeting
<input type="checkbox"/>	<input type="checkbox"/>	49	<ul style="list-style-type: none"> The Chairperson may with the consent of any meeting at which a quorum is present and shall if so directed by the meeting adjourn the meeting from time to time and from place to place. No business shall be transacted at any adjourned meeting other than the business left unfinished at the meeting from which the adjournment took place. When a meeting is adjourned for thirty days or more notice of the adjourned meeting shall be given as in the case of an original meeting. Save as aforesaid and as provided in section 103 of the Act it shall not be necessary to give any notice of an adjournment or of the business to be transacted at an

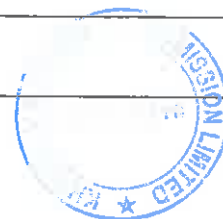

adjourned meeting.

Voting rights

- Subject to any rights or restrictions for the time being attached to any class or classes of shares on a show of hands every member present in person shall have one vote and on a poll the voting rights of members shall be in proportion to his share in the paid-up equity share capital of the company.

- A member may exercise his vote at a meeting by electronic means in accordance with section 108 and shall vote only once.

- In the case of joint holders the vote of the senior who tenders a vote whether in person or by proxy shall be accepted to the exclusion of the votes of the other joint holders. For this purpose seniority shall be determined by the order in which the names stand in the register of members.

- A member of unsound mind or in respect of whom an order has been made by any court having jurisdiction in lunacy may vote whether on a show of hands or on a poll by his committee or other legal guardian and any such committee or guardian may on a poll vote by proxy.

- Any business other than that upon which a poll has been demanded may be proceeded with pending the taking of the poll.

- No member shall be entitled to vote at any general meeting unless all calls or other sums presently payable by him in respect of shares in the company have been paid

- No objection shall be raised to the qualification of any voter except at the meeting or adjourned meeting at which the vote objected to is given or tendered and every vote not disallowed at such meeting shall be valid for all purposes. Any such objection made in due time shall be referred to the Chairperson of the meeting whose decision shall be final and conclusive.

Proxy

- The instrument appointing a proxy and the power-of-attorney or other authority if any under which it is signed or a notarised copy of that power or authority shall be deposited at the registered office of the company not less than 48 hours before the time for holding the meeting or adjourned meeting at which the person named in the instrument proposes to vote or in the case of a poll not less than 24 hours before the time appointed for the taking of the poll and in default the instrument of proxy shall not be treated as valid.

- An instrument appointing a proxy shall be in the form as prescribed in the rules made under section 105

- A vote given in accordance with the terms of an instrument of proxy shall be valid notwithstanding the previous death or insanity



	59	of the principal or the revocation of the proxy or of the authority under which the proxy was executed or the transfer of the shares in respect of which the proxy is given Provided that no intimation in writing of such death insanity revocation or transfer shall have been received by the company at its office before the commencement of the meeting or adjourned meeting at which the proxy is used.
		Board of Directors
<input type="checkbox"/>	<input checked="" type="checkbox"/>	<p>60</p> <ul style="list-style-type: none"> The day to day management of the business of the Company shall be vested with the Board of Directors of the Company or such persons as may be authorized by the Board from time to time. The Board may exercise all such powers of the Company and do all such acts, deeds and things as are not prohibited by the Act or any other law for the time being in force or by the Memorandum of Association of the Company and without prejudice to the foregoing shall be responsible for all policy matters and the supervision, direction and control of the conduct of the business affairs and operations of the Company. The first Directors of the Company shall be 1. JASPAL SINGH KUSHWAHA 2. RAJKUMAR SONKAR 3. ARVIND KUMAR. At every annual general meeting one third of such of the directors for the time being as are liable to retire by rotation or if their number is neither three nor a multiple of three then the number nearest to one third shall retire from office. The directors to retire by rotation at every annual general meeting shall be those who have been longest in office since their last appointment but as between persons who became directors on the same day those who are to retire shall in default of and subject to any subject to any agreement among themselves be determined by lot at annual general meeting at which a director retires as aforesaid the company may fill up the vacancy by appointing there retiring director or some other person there to. The Board of Directors of the Company shall consist of not less than but not more than Directors. The appointment of Directors including the Chairman, Managing Director, Whole time Director, Part time Directors shall be done in the General Meetings in accordance with the provisions of the Companies Act and Rules made there under and shall be eligible for appointment. However till the Company is a Government Company REC Power Development and Consultancy Limited (RECPDCL) the holding company shall have the full powers to recommend, nominate the name of any Directors to be appointed on the Board of the Company. Further RECPDCL shall also have the power to remove any director from office at any time in its absolute discretion. RECPDCL shall also have the right to fill any vacancies in the office of director caused by removal, resignation, death or otherwise. Subject to provisions of the Act the Company may by passing the resolution in General Meeting increase or decrease the maximum number of Directors and may alter their qualification. Further the Company may subject to the provisions of the Act remove any Director before the expiration of his period of office and appoint another person in place of him. The Board may appoint any person to act as alternate director for a Director during the later absence for a period of not less than three months from India and such appointment shall have effect and such appointee whilst he holds office as an alternate director shall be entitled to notice of meeting of the Board and to attend and vote there at accordingly but he shall not require any qualification and shall ipso facto vacate office if and when the absent Director returns to India.



338

			<p>Casual vacancies among Directors may be filled by the Board of Directors at their meeting and any person so appointed shall hold the office as per the provision of section of the Act Subject to the provisions of Section and other applicable provisions if any of the Act the Board shall have power at any time and from time to time to appoint a person as an Additional Director but so that the total number of Directors shall not at any time exceed the maximum number fixed by these Articles The Additional Director so appointed shall retire from Office at next annual General Meeting but shall be eligible for election by the company at that meeting as a Director</p>
<input type="checkbox"/>	<input type="checkbox"/>	61	<ul style="list-style-type: none"> The remuneration of the directors shall in so far as it consists of a monthly payment be deemed to accrue from day-to-day. In addition to the remuneration payable to them in pursuance of the Act the directors may be paid all travelling hotel and other expenses properly incurred by them in attending and returning from meetings of the Board of Directors or any committee thereof or general meetings of the company or in connection with the business of the company.
<input type="checkbox"/>	<input type="checkbox"/>	62	<ul style="list-style-type: none"> The Board may pay all expenses incurred in getting up and registering the company.
<input type="checkbox"/>	<input type="checkbox"/>	63	<ul style="list-style-type: none"> The company may exercise the powers conferred on it by section 88 with regard to the keeping of a foreign register and the Board may (subject to the provisions of that section) make and vary such regulations as it may think fit respecting the keeping of any such register.
<input type="checkbox"/>	<input type="checkbox"/>	64	<ul style="list-style-type: none"> All cheques promissory notes drafts hundis bills of exchange and other negotiable instruments and all receipts for monies paid to the company shall be signed drawn accepted endorsed or otherwise executed as the case may be by such person and in such manner as the Board shall from time to time by resolution determine
<input type="checkbox"/>	<input type="checkbox"/>	65	<ul style="list-style-type: none"> Every director present at any meeting of the Board or of a committee thereof shall sign his name in a book to be kept for that purpose.
<input type="checkbox"/>	<input type="checkbox"/>	66	<ul style="list-style-type: none"> Subject to the provisions of section 149 the Board shall have power at any time and from time to time to appoint a person as an additional director provided the number of the directors and additional directors together shall not at any time exceed the maximum strength fixed for the Board by the articles. Such person shall hold office only up to the date of the next annual general meeting of the company but shall be eligible for appointment by the company as a director at that meeting subject to the provisions of the Act.
			<i>Proceedings of the Board</i>
<input type="checkbox"/>	<input type="checkbox"/>	67	<ul style="list-style-type: none"> The Board of Directors may meet for the conduct of business adjourn and otherwise regulate its meetings as it thinks fit. A director may and the manager or secretary on the requisition of a director shall at any time summon a meeting of the Board.

339



<input type="checkbox"/>	<input type="checkbox"/>	68	<ul style="list-style-type: none"> Save as otherwise expressly provided in the Act questions arising at any meeting of the Board shall be decided by a majority of votes. In case of an equality of votes the Chairperson of the Board if any shall have a second or casting vote.
<input type="checkbox"/>	<input type="checkbox"/>	69	<ul style="list-style-type: none"> The continuing directors may act notwithstanding any vacancy in the Board but if and so long as their number is reduced below the quorum fixed by the Act for a meeting of the Board the continuing directors or director may act for the purpose of increasing the number of directors to that fixed for the quorum or of summoning a general meeting of the company but for no other purpose.
<input type="checkbox"/>	<input type="checkbox"/>	70	<ul style="list-style-type: none"> The Board may elect a Chairperson of its meetings and determine the period for which he is to hold office. If no such Chairperson is elected or if at any meeting the Chairperson is not present within five minutes after the time appointed for holding the meeting the directors present may choose one of their number to be Chairperson of the meeting.
<input type="checkbox"/>	<input type="checkbox"/>	71	<ul style="list-style-type: none"> The Board may subject to the provisions of the Act delegate any of its powers to committees consisting of such member or members of its body as it thinks fit. Any committee so formed shall in the exercise of the powers so delegated conform to any regulations that may be imposed on it by the Board.
<input type="checkbox"/>	<input type="checkbox"/>	72	<ul style="list-style-type: none"> A committee may elect a Chairperson of its meetings. If no such Chairperson is elected or if at any meeting the Chairperson is not present within five minutes after the time appointed for holding the meeting the members present may choose one of their members to be Chairperson of the meeting.
<input type="checkbox"/>	<input type="checkbox"/>	73	<ul style="list-style-type: none"> A committee may meet and adjourn as it thinks fit. Questions arising at any meeting of a committee shall be determined by a majority of votes of the members present and in case of an equality of votes the Chairperson shall have a second or casting vote.
<input type="checkbox"/>	<input type="checkbox"/>	74	<ul style="list-style-type: none"> All acts done in any meeting of the Board or of a committee thereof or by any person acting as a director shall notwithstanding that it may be afterwards discovered that there was some defect in the appointment of any one or more of such directors or of any person acting as aforesaid or that they or any of them were disqualified be as valid as if every such director or such person had been duly appointed and was qualified to be a director.
<input type="checkbox"/>	<input type="checkbox"/>	75	<ul style="list-style-type: none"> Save as otherwise expressly provided in the Act a resolution in writing signed by all the members of the Board or of a committee thereof for the time being entitled to receive notice of a meeting of the Board or committee shall be valid and effective as if it had been passed at a meeting of the Board or committee duly convened and held.
<input checked="" type="checkbox"/>	<input type="checkbox"/>	76	<ul style="list-style-type: none"> In case of a One Person Company where the company is having only one director all the businesses to be transacted at the meeting of the Board shall be entered into minutes book maintained under section 118 such minutes book shall be signed and dated by the director the resolution shall become effective from the date of



			signing such minutes by the director.
			Chief Executive Officer, Manager, Company Secretary or Chief Financial Officer
<input type="checkbox"/>	<input type="checkbox"/>	77	<ul style="list-style-type: none"> Subject to the provisions of the Act a chief executive officer manager company secretary or chief financial officer may be appointed by the Board for such term at such remuneration and upon such conditions as it may think fit and any chief executive officer manager company secretary or chief financial officer so appointed may be removed by means of a resolution of the Board A director may be appointed as chief executive officer manager company secretary or chief financial officer
<input type="checkbox"/>	<input type="checkbox"/>	78	<ul style="list-style-type: none"> A provision of the Act or these regulations requiring or authorising a thing to be done by or to a director and chief executive officer manager company secretary or chief financial officer shall not be satisfied by its being done by or to the same person acting both as director and as or in place of chief executive officer manager company secretary or chief financial officer.
			The Seal
<input type="checkbox"/>	<input type="checkbox"/>	79	<ul style="list-style-type: none"> The Board shall provide for the safe custody of the seal. The seal of the company shall not be affixed to any instrument except by the authority of a resolution of the Board or of a committee of the Board authorised by it in that behalf and except in the presence of at least two directors and of the secretary or such other person as the Board may appoint for the purpose and those two directors and the secretary or other person aforesaid shall sign every instrument to which the seal of the company is so affixed in their presence.
			Dividends and Reserve
<input type="checkbox"/>	<input type="checkbox"/>	80	<ul style="list-style-type: none"> The company in general meeting may declare dividends but no dividend shall exceed the amount recommended by the Board.
<input type="checkbox"/>	<input type="checkbox"/>	81	<ul style="list-style-type: none"> Subject to the provisions of section 123 the Board may from time to time pay to the members such interim dividends as appear to it to be justified by the profits of the company.
<input type="checkbox"/>	<input type="checkbox"/>	82	<ul style="list-style-type: none"> The Board may before recommending any dividend set aside out of the profits of the company such sums as it thinks fit as a reserve or reserves which shall at the discretion of the Board be applicable for any purpose to which the profits of the company may be properly applied including provision for meeting contingencies or for equalizing dividends and pending such application may at the like discretion either be employed in the business of the company or be invested in such investments (other than shares of the company) as the Board may from time to time think fit. The Board may also carry forward any profits which it may consider necessary not to divide without setting them aside as a reserve
<input type="checkbox"/>	<input type="checkbox"/>		<ul style="list-style-type: none"> Subject to the rights of persons if any entitled to shares with special rights as to dividends all dividends shall be declared and paid according to the amounts paid or credited as paid on the shares in



341

		83	respect whereof the dividend is paid but if and so long as nothing is paid upon any of the shares in the company dividends may be declared and paid according to the amounts of the shares. No amount paid or credited as paid on a share in advance of calls shall be treated for the purposes of this regulation as paid on the share. All dividends shall be apportioned and paid proportionately to the amounts paid or credited as paid on the shares during any portion or portions of the period in respect of which the dividend is paid but if any share is issued on terms providing that it shall rank for dividend as from a particular date such share shall rank for dividend accordingly.
<input type="checkbox"/>	<input type="checkbox"/>	84	<ul style="list-style-type: none"> The Board may deduct from any dividend payable to any member all sums of money if any presently payable by him to the company on account of calls or otherwise in relation to the shares of the company.
<input type="checkbox"/>	<input type="checkbox"/>	85	<ul style="list-style-type: none"> Any dividend interest or other monies payable in cash in respect of shares may be paid by cheque or warrant sent through the post directed to the registered address of the holder or in the case of joint holders to the registered address of that one of the joint holders who is first named on the register of members or to such person and to such address as the holder or joint holders may in writing direct. Every such cheque or warrant shall be made payable to the order of the person to whom it is sent.
<input type="checkbox"/>	<input type="checkbox"/>	86	<ul style="list-style-type: none"> Any one of two or more joint holders of a share may give effective receipts for any dividends bonuses or other monies payable in respect of such share.
<input type="checkbox"/>	<input type="checkbox"/>	87	<ul style="list-style-type: none"> Notice of any dividend that may have been declared shall be given to the persons entitled to share therein in the manner mentioned in the Act.
<input type="checkbox"/>	<input type="checkbox"/>	88	<ul style="list-style-type: none"> No dividend shall bear interest against the company.
			Accounts
<input type="checkbox"/>	<input type="checkbox"/>	89	<ul style="list-style-type: none"> The Board shall from time to time determine whether and to what extent and at what times and places and under what conditions or regulations the accounts and books of the company or any of them shall be open to the inspection of members not being directors. No member (not being a director) shall have any right of inspecting any account or book or document of the company except as conferred by law or authorised by the Board or by the company in general meeting.
			Winding up
<input type="checkbox"/>	<input type="checkbox"/>		<ul style="list-style-type: none"> Subject to the provisions of Chapter XX of the Act and rules made thereunder if the company shall be wound up the liquidator may with the sanction of a special resolution of the company and any other sanction required by the Act divide amongst the members in specie or kind the whole or any part of the assets of the company whether they shall consist of property of the same kind or not. For the purpose aforesaid the liquidator may set such value as he



342

		90	deems fair upon any property to be divided as aforesaid and may determine how such division shall be carried out as between the members or different classes of members. The liquidator may with the like sanction vest the whole or any part of such assets in trustees upon such trusts for the benefit of the contributories if he considers necessary but so that no member shall be compelled to accept any shares or other securities whereon there is any liability.
			<i>Indemnity</i>
		91	<ul style="list-style-type: none"> Every officer of the company shall be indemnified out of the assets of the company against any liability incurred by him in defending any proceedings whether civil or criminal in which judgment is given in his favour or in which he is acquitted or in which relief is granted to him by the court or the Tribunal.
			<i>Others</i>
		92	•

Subscriber Details

S. No.	Subscriber Details				
	*Name, Address, Description and Occupation	DIN / PAN / Passport number	*Place	DSC	Dated
1	REC POWER DEVELOPMENT AND CONSULTANCY LIMITED, CORE-4, SCOPE COMPLEX, 7, LODHI ROAD, NEW DELHI-110003, THROUGH ITS CEO RAJESH KUMAR S/O SHRINIWAS GUPTA R/O L-187, NAG MANDIR KE PAS SHASTRI NAGAR, ASHOK VIHAR, DELHI-110052, OCCUPATION-SERVICES	06941428	NEW DELHI	RAJESH KUMAR	06/10/2023
2	MOHAN LAL KUMAWAT S/O SHRI RAMU RAM KUMAWAT NOMINEE OF REC POWER DEVELOPMENT AND CONSULTANCY LIMITED FLAT NO 142 TOWER -1 GC EMERALD, RAMPRASTHA GREENS VAISHALI SECTOR-7, GHAZIABAD-201010, UTTAR PRADESH, OCCUPATION-SERVICE	07682898	NEW DELHI	Mohan Lal Kumawat	06/10/2023
3	THANGARAJAN BOSH S/O SHRI SITHAN THANGARAJAN NOMINEE OF REC POWER DEVELOPMENT AND CONSULTANCY LIMITE D R/O APARTMENT NO S-2, MIDDLE PORTION 2-B, JANGPURA, MATHURA ROAD, NEW DELHI-110014, OCCUPATION-SERVICE	02772316	NEW DELHI	Thangarajan S. Bosh Chandra Bosh	06/10/2023
4	SAHAB NARAIN S/O HARI NARAIN NOMINEE OF REC POWER DEVELOPMENT AND CONSULTANCY LIMITED R/O A-1, FLAT NO 103, SOAMI NAGAR, MALVIYA NAGAR,	03641879	NEW DELHI	SAHAB NARAIN	06/10/2023



	DELHI-110017, OCCUPATION-SERVICE				
5	ALOK SINGH S/O JAGDHARI SINGH NOMINEE OF REC POWER DEVELOPMENT AND CONSULTANCY LIMITED R/O MF-23, ELDECO MANSIONZ, SECTOR-48, SOHNA ROAD, GURUGRAM - 122018, OCCUPATION-SERVICE	07498786	NEW DELHI	ALOK SINGH	06/10/2023
6	PUTHIYARKATTU SHIVARAMAN HARIHARAN S/O SHRI PUTHIYARAKAT VELAYUDHAN SIVARAMAN NOMINEE OF REC POWER DEVELOPMENT AND CONSULTANCY LIMITED FLAT NO.104, SADAR APARTMENT, MAYUR VIHAR EXTENTION, PHASE-1, PLOT NO.9, NEW DELHI-110091, OCCUPATION-SERVICE	08657652	NEW DELHI	P.S. HARIHARAN	06/10/2023
7	ARVIND KUMAR S/O NAND KISHOR SINGH NOMINEE OF REC POWER DEVELOPMENT AND CONSULTANCY LIMITED R/O T4-8A, SAI VATIKA APARTMENT, SECTOR-63, FARIDABAD - 121004, OCCUPATION-SERVICE	10342637	NEW DELHI	ARVIND KUMAR	06/10/2023

Signed before me

Name Prefix (ACA/FCA/ACS/ FCS/ACMA/ FCMA)	*Name of the witness	*Address, Description and Occupation	*DIN / PAN / Passport number / Membership		DSC	Dated
FCA	VINAY KUMAR	1803, TOWER-9, LA RESIDENTIA, TECH ZONE-4, GREATER NOIDA WEST-201306	402996	NEW DELHI	Vinay Digitally signed by Vinay Kumar DN: cn=Vinay Kumar, o=REC 402996	06/10/2023



Date: 21.10.2024

CERTIFICATE BY BID EVALUATION COMMITTEE

Subject: Selection of Successful Bidder as Transmission Service Provider to establish "Transmission System for evacuation of power from Potential Renewable Energy Zone in Khavda Area of Gujarat under Phase-V (8 GW): Part A" through tariff based competitive bidding process.

It is certified that:

- The entire bid process has been carried out in accordance with the "Tariff based Competitive Bidding Guidelines for Transmission Service" and "Guidelines for encouraging competition in development of the Transmission Projects" issued by Ministry of Power, Govt. of India under Section 63 of the Electricity Act, 2003 as amended from time to time.
- M/s Power Grid Corporation of India Limited, with the lowest annual transmission charges of Rs. 40,828.67 million, emerged as the successful Bidder after the conclusion of electronic reverse auction.
- The transmission charges of Rs. 40,828.67 million discovered after electronic reverse auction is acceptable.



(Rajesh Kumar Singh)
General Manager,
CCGRO-II, SBI
Chairman, BEC

(Bhagwan Sahay Bairwa)
Chief Engineer (I/C),
PSPA-II Division, CEA
Member, BEC

(Bhanwar Singh Meena)
Director (PSE&TD), CEA
Member, BEC

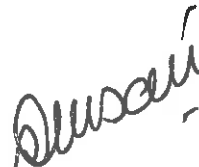
(P. D. Lone)
SE, WRPC
Member, BEC

(S. M. Soni)
SE, GETCO
Member, BEC

(Rajkumar Sonkar)
Chairman -SPV
Convener - Member, BEC





345

1. To constitute, and defend legal cases, sign and verify plaints, written statements, petitions and objections, memorandum of appeal, claims, affidavits, applications, re-applications and pleadings of all kinds and to file them in Central Electricity Regulatory Commission (CERC), State Electricity Regulatory Commissions (SERCs), Appellate Tribunal for Electricity (ATE), Civil, Criminal or Revenue courts, Arbitration, Labour Court, Industrial Tribunal, High Court and Supreme Court, whether having original or appellate jurisdiction and before Government or Local Authorities or Registration Authorities, Tax Authorities, Tribunals, etc.
2. To appear, before various Courts / Tribunals / CERC / SERCs / Appellate Tribunal for Electricity.
3. To appoint any Advocate, Vakil, Pleader, Solicitor or any other legal practitioner as Attorney to appear and conduct case proceedings on behalf of the company and to sign Vakalatnama.
4. To compromise, compound or withdraw cases from any Court / Tribunal / CERC / SERCs / Appellate Tribunal for Electricity.
5. To file petitions/applications or affidavits before the Supreme Court / High Court / CERC / SERCs / Appellate Tribunal for Electricity and to obtain the copies of documents, papers, records etc.
6. To file and receive back documents, to deposit and withdraw money from Courts, Tribunal, Registrar's Office and other Government or Local Authorities and to issue valid receipts thereof.
7. To apply for and obtain refund of stamp duty or court fee, etc.
8. To issue notices and accept service of any summons, notices or orders issued by any Court / Tribunal / CERC / SERCs / Appellate Tribunal for Electricity on behalf of the Company.
9. To execute deeds, agreements, bonds and other documents and returns in connection with the affairs of the company and file them or cause to be filed for Registration, whenever necessary.
10. To issue Project Authority Certificate(s) in respect of contracts for Load Despatch & Communication Systems, Transmission Systems etc. and to lodge claims with the Railways, Transporters, Shipping Agents and Clearing Agents and to settle/compromise such claims.
11. To lodge claims with the Insurance companies, to settle/compromise such claims and on satisfactory settlement thereof, to issue letters of subrogation/power of attorney in favour of Insurance companies.
12. To execute, sign and file applications, undertakings, agreements etc. to or with the Central / State Government(s) / Body(ies) to obtain 'right of way' or any of other Right(s) / Privilege(s) etc.
13. To execute, sign and file applications, undertakings, agreements, bills, documents etc. to or with the Central / State Government(s) / Body(ies) and other authorities / entities including Central Transmission Utility (CTU)/Power System Operation Corporation Limited (POSOCO) / Central Electricity Authority (CEA)/ CERC with respect to Commissioning



of the Project, realization of Transmission charges, to obtain 'right of way' or any of other Right(s) / Privilege(s) etc.

14. To execute Transmission Service Agreement (TSA) with Central Transmission Utility of India Limited (CTUIL)
15. To execute Consultancy, Funding and other Agreements.
16. To act as administrator for e-filing process with CERC and other Statutory authorities.
17. Generally to do all lawful acts. necessary for the above mentioned purposes.

The Company hereby agrees to ratify and confirm all and whatsoever the said Attorney shall lawfully do execute or perform or cause to be done, executed or performed in exercise of the power or authority conferred under and by virtue of this Power of Attorney.

M.P. Rathore
.....

Signed by the within named
Khavda V-A Power Transmission Limited
through the hand of
Duly authorized by the Board to issue such Power of Attorney

Dated this 19th day of Nov, 2024

Accepted

* *Amit Kumar Jain*
.....
Signature of Attorney

Name: Sh. Amit Kumar Jain
Designation: Finance Incharge, Khavda V-A Power Transmission Limited
Address: A-801, Times Residency, Sector-63, Gurgaon - 122001

* *Amit Kumar Jain*
Attested
M.P. Rathore
.....

(Signature of the Executant)

Name: *M.P. Rathore*
Designation: *Director*

Address: B-9, Qutab Institutional Area, Katwaria Sarai, New Delhi - 110 016



.....
Signature and Stamp of Notary of the place of execution
WITNESS



ATTESTED
NOTARY PUBLIC
DELHI

19 NOV 2024