

**BEFORE THE CENTRAL ELECTRICITY REGULATORY COMMISSION  
NEW DELHI**

APPLICATION No :.....

**IN THE MATTER OF**

Application under Section 63 of the Electricity Act, 2003 for Adoption of Transmission Charges with respect to the Transmission System being established by the Bhadla III Transmission Limited (a 100% wholly owned subsidiary of Power Grid Corporation of India Limited)

**Bhadla III Transmission Limited**

**(A 100% wholly owned subsidiary of Power Grid Corporation of India Limited)**

**Registered office:** B-9, Qutab Institutional Area, Katwaria Sarai, New Delhi 110 016

**Address for correspondence:** C/o ED (TBCB), Power Grid Corporation of India Limited, Saudamini, Plot no.2, Sector -29, Gurgaon 122001

**AND**

Chief Operating Officer,  
Central Transmission Utility of India Ltd,  
Saudamini, Plot no.2, Sector -29,  
Gurgaon 122001.....

**RESPONDENT(S)**

And Others

**INDEX**

Sl. No.	Description	Enclosures	Page No.
1	CERC Letter	-	iii
2	Form 1	-	iv-v
3	Memo of Appearance		vi
4	Dispatch proof	-	vii-ix
5	Letter for registration	-	4
6	Memo of parties	-	5-7
7	Affidavit	-	8-9
8	Application	-	10-16
9	Extract of Gazette notification no. CG-DL-E-08122021-231686 dated 06.12.2021 has notified PFC Consulting Limited to be the Bid Process Coordinator (BPC)	Annexure-1	17-21
10	Certificate of Incorporation of Bhadla III Transmission Limited	Annexure-2	22
11	Memorandum of Association and Articles of Association of Bhadla III Transmission Limited	Annexure-3	23-61
12	Global Invitation for Qualification as published in the newspapers	Annexure-4	62-64
13	Extract of the RFP document as provided by BPC	Annexure-5	65-66
14	Certificate by Bid Evaluation Committee	Annexure-6	67
15	Copy of Letter of Intent (LoI)	Annexure-7	68-71
16	Copy of relevant extract of Request for Proposal (RFP) along with letters from BPC	Annexure-8	72-74



i

Duo.

17	Copy of Transmission Service Agreement (TSA)	Annexure-9	75-291
18	Copy of the BPC letters dated 06.06.2023 and 18.09.2023	Annexure-10	292-296
19	Copy of Share purchase agreement (SPA)	Annexure-11	297-313
20	SLD of the transmission scheme	Annexure-12	314

Place: New Delhi

Date: 4/10/23



310.. FILED BY  
Bhadla III Transmission Limited

# Bhadla III Transmission Limited

( A 100% wholly owned subsidiary Power Grid Corporation of India Limited)

B-9, Qutab Institutional Area, Katwaria Sarai, New Delhi - 110 016

CIN : U74999DL2022GOI399208

Ref: PG\_BIIITL/

Dated: 4/10/23

To,  
The Secretary,  
Central Electricity Regulatory Commission,  
3<sup>rd</sup> & 4<sup>th</sup> Floor, Chanderlok Building,  
36, Janpath, New Delhi - 110 001.

Sub.: Application under Section 63 of the Electricity Act, 2003 for Adoption of Transmission Charges with respect to the Transmission System being established by the Bhadla III Transmission Limited (a 100% wholly owned subsidiary of Power Grid Corporation of India Limited)

Sir,

Three copies (1 original + 2 copies) of the application for the above subject matter have been enclosed and e-filing has been done on CERC website. As per the public notice issued on 28.08.2010 by the Hon'ble Commission, the amount of Rs. 25,00,000/- (Rupees Twenty Five Lakhs only) for filing the application is being paid through RTGS and in accordance with the Regulations 12 (2), Payment of Fees Regulations 2012, Form-1 duly filled in against the aforementioned application is also enclosed herewith.

Copies of the application are being forwarded to the CTUIL (Nodal Agency) and to the Bid Process Coordinator and beneficiaries of the Northern Region as party to the Petition based on the list of the beneficiaries furnished by the CTUIL. The complete application along with Annexure is posted on the website: [www.powergrid.in/subsidiaries](http://www.powergrid.in/subsidiaries)

Thanking You,



Yours faithfully,

*Uendra Singh*

(Uendra Singh)  
Project Incharge

**Bhadla III Transmission Limited**

Mobile: +91-9001894202; email : [tbcb@powergrid.in](mailto:tbcb@powergrid.in)

Enclosures: As above

iii



**Form-I**

**Particulars**

1. Name of the Petitioner : **Bhadla III Transmission Limited**  
(A 100% wholly owned subsidiary of  
Power Grid Corporation of India Limited)
2. Address of the Petitioner/Applicant : **Bhadla III Transmission Limited**  
(A 100% wholly owned subsidiary of Power Grid  
Corporation of India Limited)  
Regd. Address:  
B-9, Qutab Institutional Area,  
Katwaria Sarai, New Delhi-110 016  
Address for correspondence:  
Project Incharge, Bhadla III  
Transmission Limited, C/o  
ED(TBCB), Power Grid Corporation  
of India Ltd, Saudamini, Plot no.2,  
Sector - 29, Gurgaon 122001
3. Subject Matter : Application under Section 63 of the  
Electricity Act, 2003 for Adoption of  
Transmission Charges with respect to the  
Transmission System being established  
by the Bhadla III Transmission Limited  
(a 100% wholly owned subsidiary of  
Power Grid Corporation of India  
Limited)
4. Petition No., if any : Not yet received
5. Details of generation assets : NOT APPLICABLE  
(a) generating station/units  
(b) Capacity in MW  
(c) Date of commercial operation  
(d) Period for which fee paid  
(e) Amount of fee paid  
(f) Surcharge, if any
6. Details of transmission assets : Assets under implementation by  
(a) Transmission line and sub-stations Bhadla III Transmission Limited  
(b) Date of commercial operation  
(c) Period for which fee paid  
(d) Amount of fee paid  
(g) Surcharge, if any
7. Fee paid for Adoption of tariff for :  
(a) Generation asset NO

iv





- (b) Transmission asset : YES
8. Application fee for licence : NOT APPLICABLE  
(a) Trading licence  
(b) Transmission licence  
(c) Period for which paid  
(d) Amount of fee paid
9. Fees paid for Miscellaneous Application : NOT APPLICABLE
10. Fees paid for Interlocutory Application : NOT APPLICABLE
11. Fee paid for Regulatory Compliance petition : NOT APPLICABLE
12. Fee paid for Review Application : NOT APPLICABLE
13. Licence fee for inter-State Trading : NOT APPLICABLE  
(a) Category  
(b) Period  
(c) Amount of fee paid  
(d) Surcharge, if any
14. Licence fee for inter-State Transmission : NOT APPLICABLE  
(a) Expected/Actual transmission charge  
(b) Period  
(c) Amount of fee calculated as a percentage of transmission charge.  
(d) Surcharge, if any
15. Annual Registration Charge for Power Exchange : NOT APPLICABLE  
(a) Period  
(b) Amount of turnover  
(c) Fee paid  
(d) Surcharge, if any
16. Details of fee remitted  
(a) UTR No. : ICICR 22023100300022432  
(b) Date of remittance : 3/10/2023  
(c) Amount remitted : Rs.25,00,000 (Rupees Twenty Five Lakh only)



Mo.  
Signature of the authorized signatory with date

✓

**BEFORE  
THE CENTRAL ELECTRICITY REGULATORY COMMISSION  
NEW DELHI**

Petition No.: -----

**IN THE MATTER OF:** Application under Section 63 of the Electricity Act, 2003 for Adoption of Transmission Charges with respect to the Transmission System being established by the Bhadla III Transmission Limited (a 100% wholly owned subsidiary of Power Grid Corporation of India Limited)

**MEMO OF APPEARANCE**

**Bhadla III Transmission Limited** --- PETITIONER

1. Pankaj Pandey, ED, POWERGRID
2. Shri Upendra Singh, Project Incharge, Bhadla III Transmission Limited
3. Ashwini Kumar Das, GM, POWERGRID

**Place:** Gurgaon  
**Date:** 4/10/23



**Filed by  
Bhadla III Transmission Limited  
Represented by**

*Upendra Singh*  
**Upendra Singh  
Project Incharge  
(Bhadla III Transmission Limited)**



पावरग्रिड

# पावरग्रिड कॉर्पोरेशन ऑफ इंडिया लिमिटेड

कार्पोरेट आफिस : प्लॉट नं-02, सेक्टर-29, गुडगाँव (हरियाणा)

(स्पीड पोस्ट बुकिंग लिस्ट)

भारतीय डाक



India Post

बी.एन.पी.एल. कोड : एच-जी आर जी, एन.एस.पी.सी. गुडगाँव - 122016

दिनांक ५/10/2023

पृष्ठ संख्या 1

क्रम.सं.	नाम	पता	शहर	राज्य	पिनकोड	वजन	बारकोड	टिप्पणी
1.	Director (SO)	Genl Controller of India Ltd, New Delhi	New Delhi		110016	1500g	EH470885106IN	
2.	Director (PRC)	Hpptcl. Panjaji, Shimla			171005	11	EH470885110IN	
3.	Director (WPP)	UP Power Transmission, Lucknow			226001	11	EH470885123IN	
4.	Director	Punjab State Transmission, Patiala			147001	11	EH470885137IN	
5.	Development Commissioner	Power, Jammu			-	11	EH470885145IN	
6.	Director (projects)	Power Transmission, Dehradun			-	11	EH470885154IN	
7.	Director (Technical)	Rajasthan Rajya, Jaipur			302005	11	EH470885168IN	







पावरग्रिड

# पावरग्रिड कॉर्पोरेशन ऑफ इंडिया लिमिटेड

कार्पोरेट आफिस : प्लॉट नं-02, सेक्टर-29, गुडगाँव (हरियाणा)

(स्पीड पोस्ट बुकिंग लिस्ट)

भारतीय डाक



India Post

बी.एन.पी.एल. कोड : एच-जी आर जी, एन.एस.पी.सी. गुडगाँव - 122016

दिनांक. 4/10/2025

पृष्ठ संख्या 2

क्रम सं.	नाम	पता	शहर	राज्य	पिनकोड	वजन	बारकोड	टिप्पणी
8.	Director (Technical)	Har yama vidyut prasarak	panchkula	Haryana	150001	11	EH4708851711N	
9.	Chief operating officer,	C.T.U Gurgaon	Gurgaon	Haryana	122001	11	EH4708851851N	
10.	Gen.PFC Consulting Limited,	new Delhi	New Delhi	Delhi	110001	11	EH4708851991N	
11.	Shri Rajesh Kumar Gupta,	Adani Renewable,	Ahmedabad	Gujarat	382421	11	EH4708852081N	
12.	Chief Engineer, Central Electricity,	New Delhi	New Delhi	Delhi	110066	11	EH4708852111N	
13.	Chief Engineer, Chandigarh Electricity,	Chandigarh	Chandigarh	Chandigarh	161009	11	EH4708852251N	
14.	Director, Delhi Transco Ltd.	New Delhi	New Delhi	Delhi	110002	11	EH4708852391N	





पावरग्रिड

# पावरग्रिड कॉर्पोरेशन ऑफ इंडिया लिमिटेड

कार्पोरेट ऑफिस : प्लॉट नं-02, सेक्टर-29, गुडगाँव (हरियाणा)

(स्पीड पोस्ट बुकिंग लिस्ट)

भारतीय डाक



बी.एन.पी.एल. कोड : एच-जी आर जी, एन.एस.पी.सी. गुडगाँव - 122016

दिनांक 4/10/2023

पृष्ठ संख्या 3

क्रम.सं.	नाम	पता	शहर	राज्य	पिनकोड	वजन	बारकोड	टिप्पणी
15.	Member Secretary, North Western Regional power, New Delhi				110016	150kg	 EH470885242IN	



**BEFORE**  
**THE CENTRAL ELECTRICITY REGULATORY**  
**COMMISSION**  
**NEW DELHI**

**Application under Section 63 of the Electricity Act, 2003 for adoption of Transmission charges with respect to the Transmission System being established by the Bhadla III Transmission Limited (a 100% wholly owned subsidiary of Power Grid Corporation of India Limited)**

**APPLICATION NO :**

**Bhadla III Transmission Limited**  
(A 100% wholly owned subsidiary of Power Grid Corporation of India Limited)

**Registered office:**

B-9, Qutab Institutional Area, Katwaria Sarai, New Delhi 110 016

**Address for correspondence:**

C/o ED (TBCB), Power Grid Corporation of India Limited  
Saudamini, Plot no.2, Sector -29, Gurgaon 122001  
GURGAON-122 001 (HARYANA)





**BEFORE THE CENTRAL ELECTRICITY REGULATORY COMMISSION  
NEW DELHI**

APPLICATION No :.....

**IN THE MATTER OF**

Application under Section 63 of the Electricity Act, 2003 for Adoption of Transmission Charges with respect to the Transmission System being established by the Bhadla III Transmission Limited (a 100% wholly owned subsidiary of Power Grid Corporation of India Limited)

**Bhadla III Transmission Limited**

(A 100% wholly owned subsidiary of Power Grid Corporation of India Limited)

Registered office: B-9, Qutab Institutional Area, Katwaria Sarai, New Delhi 110 016

Address for correspondence: C/o ED (TBCB), Power Grid Corporation of India Limited, Saudamini, Plot no.2, Sector -29, Gurgaon 122001

**AND**

Chief Operating Officer,  
Central Transmission Utility of India Ltd,  
Saudamini, Plot no.2, Sector -29,  
Gurgaon 122001.....

**RESPONDENT(S)**

And Others

**INDEX**

Sl. No	Description	Annexure No.	Page No.
1.	Letter for registration	-	4
2.	Memo of parties	-	5-7
3.	Affidavit	-	8-9
4.	Application	-	10-16
5.	Extract of Gazette notification no. CG-DL-E-08122021-231686 dated 06.12.2021 has notified PFC Consulting Limited to be the Bid Process Coordinator (BPC)	Annexure-1	17-21
6.	Certificate of Incorporation of Bhadla III Transmission Limited	Annexure-2	22-22
7.	Memorandum of Association and Articles of Association of Bhadla III Transmission Limited	Annexure-3	23-61
8.	Global Invitation for Qualification as published in the newspapers	Annexure-4	62-64
9.	Extract of the RFP document as provided by	Annexure-5	65-66

2

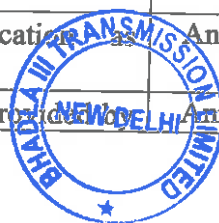

300..

	BPC		
10.	Certificate by Bid Evaluation Committee	Annexure-6	67
11.	Copy of Letter of Intent (LoI)	Annexure-7	68-71
12.	Copy of relevant extract of Request for Proposal (RFP) along with letters from BPC	Annexure-8	72-74
13.	Copy of Transmission Service Agreement (TSA)	Annexure-9	75-291
14.	Copy of the BPC letters dated 06.06.2023 and 18.09.2023	Annexure-10	292-296
15.	Copy of Share purchase agreement (SPA)	Annexure-11	297-313
16.	SLD of the transmission scheme	Annexure-12	314

**Filed by**  
**Bhadla III Transmission Limited**  
(A 100% wholly owned subsidiary of Power Grid Corporation of India Limited)

*Signature*

**Represented by Upendra Singh**  
**Project Incharge, Bhadla III Transmission Limited**

**Place: New Delhi**  
**Date: 27/09/2023**



**BEFORE THE CENTRAL ELECTRICITY REGULATORY COMMISSION  
NEW DELHI**

**APPLICATION No :.....**

**IN THE MATTER OF**

Application under Section 63 of the Electricity Act, 2003 for Adoption of Transmission Charges with respect to the Transmission System being established by the Bhadla III Transmission Limited (a 100% wholly owned subsidiary of Power Grid Corporation of India Limited)

**Bhadla III Transmission Limited**

**(A 100% wholly owned subsidiary of Power Grid Corporation of India Limited)**

**Registered office:** B-9, Qutab Institutional Area, Katwaria Sarai, New Delhi 110 016

**Address for correspondence:** C/o ED (TBCB), Power Grid Corporation of India Limited, Saudamini, Plot no.2, Sector -29, Gurgaon 122001

**AND**

Chief Operating Officer,  
Central Transmission Utility of India Ltd,  
Saudamini, Plot no.2, Sector -29,  
Gurgaon 122001.....

**RESPONDENT(S)**

And Others

To  
The Secretary  
Central Electricity Regulatory Commission  
New Delhi

Sir,

The application filed under Section 63 of the Electricity Act, 2003 for Adoption of Transmission Charges with respect to the Transmission System being established by the Bhadla III Transmission Limited (A 100% wholly owned subsidiary of Power Grid Corporation of India Limited) for which transmission charges are determined through transparent process of bidding in accordance with the guidelines issued by the Central Government, may please be registered.

**Applicant**

**Bhadla III Transmission Limited**

**(A 100% wholly owned subsidiary of Power Grid Corporation of India Limited)**

*U.S.*

**Represented by Upendra Singh**

**Project Incharge, Bhadla III Transmission Limited**

**Place: New Delhi**

**Date: 27/09/2023**

4





**BEFORE THE CENTRAL ELECTRICITY REGULATORY COMMISSION  
NEW DELHI**

**APPLICATION No :.....**

**IN THE MATTER OF**

Application under Section 63 of the Electricity Act, 2003 for Adoption of Transmission Charges with respect to the Transmission System being established by the Bhadla III Transmission Limited (a 100% wholly owned subsidiary of Power Grid Corporation of India Limited)

**Bhadla III Transmission Limited**

**(A 100% wholly owned subsidiary of Power Grid Corporation of India Limited)**

**Registered office:** B-9, Qutab Institutional Area, Katwaria Sarai, New Delhi 110 016  
**Address for correspondence:** C/o ED (TBCB), Power Grid Corporation of India Limited, Saudamini, Plot no.2, Sector -29, Gurgaon 122001

**AND**

Chief Operating Officer,  
Central Transmission Utility of India Ltd,  
Saudamini, Plot no.2, Sector -29,  
Gurgaon 122001

And Others

To  
The Secretary  
Central Electricity Regulatory Commission  
New Delhi

**MEMO OF PARTIES**

**Bhadla III Transmission Limited**

**(A 100% wholly owned subsidiary of Power Grid Corporation of India Limited)**

**Registered office:** B-9, Qutab Institutional Area, Katwaria Sarai, New Delhi 110 016  
**Address for correspondence:** C/o ED (TBCB), Power Grid Corporation of India Limited, Saudamini, Plot no.2, Sector -29, Gurgaon 122001

**VERSUS**

1.	Chief Operating Officer, Central Transmission Utility of India Ltd, Saudamini, Plot no.2, Sector -29, Gurgaon 122001	...Respondent
----	---	---------------



*me.*

2.	General Manager, PFC Consulting Limited 9 <sup>th</sup> Floor, A-Wing, Statesman House Connaught Place, New Delhi - 110001, India	....Respondent
3	Shri Rajesh Kumar Gupta General Manager Adani Renewable Energy Holding Four Limited, 4th Floor, South Wing, Adani Corporate House, Shantigram, S G Highway Ahmedabad 382421	....Respondent
4.	Chief Engineer (PSP&A - I) Central Electricity Authority Sewa Bhawan, R.K.Puram, New Delhi-110 066	....Respondent
5.	Member Secretary Northern Regional Power Committee 18A, Shaheed Jeet Singh Sansanwal Marg, Katwaria Sarai, New Delhi - 110 016	....Respondent
6.	Director (Operations) Delhi Transco Ltd. Shakti Sadan, Kotla Road, New Delhi-110 002	....Respondent
7.	Director (SO) Grid Controller of India Limited (erstwhile Power System Operation Corporation Ltd.) 9th Floor, IFCI Towers, 61, Nehru Place, New Delhi-110 016	....Respondent
8.	Director (P&C) HPPTCL, Head office, Himfed Bhawan, Panjari, Shimla- 171005	....Respondent
9.	Director(W&P) UP Power Transmission Company Ltd. Shakti Bhawan Extn, 3rd floor, 14, Ashok Marg, Lucknow-226001	....Respondent
10.	Director (Technical) Punjab State Transmission Corp. Ltd. Head Office, The Mall, Patiala - 147001, Punjab	....Respondent
11.	Director (Projects) Power Transmission Corporation of Uttarakhand Ltd. Vidyut Bhawan, Near ISBT Crossing, Saharanpur Road, Majra, Dehradun	....Respondent
12.	Development Commissioner (Power) Power Development Department Grid Substation Complex, Janipur, Jammu	....Respondent



*210..*

13.	Director (Technical) Rajasthan Rajya Vidyut Prasaran Nigam Ltd. Vidyut Bhawan, Jaipur, Rajasthan-302005	....Respondent
14.	Director (Technical) Haryana Vidyut Prasaran Nigam Ltd. Shakti Bhawan, Sector-6, Panchkula-134109, Haryana	....Respondent
15.	Chief Engineer (Operation) Administration of Chandigarh Electricity Department, UT Secretariat Sector-9 D, Chandigarh - 161009	....Respondent

Do..





**BEFORE THE HON'BLE CENTRAL ELECTRICITY REGULATORY COMMISSION  
NEW DELHI**

**APPLICATION NO:.....**

**IN THE MATTER OF**

Application under Section 63 of the Electricity Act, 2003 for Adoption of Transmission Charges with respect to the Transmission System being established by the Bhadla III Transmission Limited (a 100% wholly owned subsidiary of Power Grid Corporation of India Limited)

**Bhadla III Transmission Limited**

**(A 100% wholly owned subsidiary of Power Grid Corporation of India Limited)**

**Registered office:** B-9, Qutab Institutional Area, Katwaria Sarai, New Delhi 110 016

**Address for correspondence:** C/o ED (TBCB), Power Grid Corporation of India Limited, Saudamini, Plot no.2, Sector -29, Gurgaon 122001

**AND**

Chief Operating Officer,  
Central Transmission Utility of India Ltd,  
Saudamini, Plot no.2, Sector -29,  
Gurgaon 122001.....

**RESPONDENT(S)**

And Others

**AFFIDAVIT**

I, Upendra Singh, son of Late Shri R.D. Singh residing at House No. 5-D-66, Jai Narayan Vyas (JNV) Colony, Bikaner (Rajasthan) do hereby solemnly affirm and state as follows:

1. I am the Authorised Signatory of the Applicant Company in the above matter and I am duly authorized by the Applicant Company to affirm this affidavit. I say that I am conversant with the facts and circumstances of this case.
2. The statements made in paragraphs of the application, are true to my knowledge and belief based on the information received and I believe them to be true.
3. I say that there are no proceedings pending in any court of law/ tribunal or arbitrator or any other authority, wherein the Applicant is a party and where issues arising and/ or reliefs sought are identical or similar to the issues in the matter pending before the Hon'ble Commission.



*Upendra Singh*

8

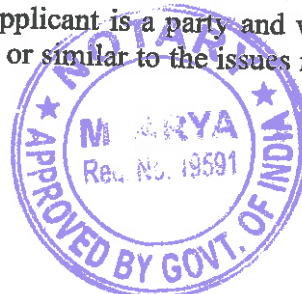

Do.

**Upendra Singh**  
Authorised Signatory  
**Bhadla III Transmission Limited**  
(A 100% wholly owned subsidiary of Power Grid Corporation of India Limited)

Place: New Delhi  
Date: 27/09/2023

**VERIFICATION:**

I, the Deponent above named hereby solemnly hereby affirms that the contents of my above affidavit are true to my knowledge, no part of it is false and nothing material has been concealed there from. Verified by me on this the 27<sup>th</sup> day of September 2023 at New Delhi.

27 SEP 2023

Do.  
Deponent

Witness



**ATTESTED**  
**NOTARY PUBLIC**

27 SEP 2023



BEFORE THE CENTRAL ELECTRICITY REGULATORY COMMISSION  
NEW DELHI

APPLICATION NO:.....

IN THE MATTER OF

Application under Section 63 of the Electricity Act, 2003 for Adoption of Transmission Charges with respect to the Transmission System being established by the Bhadla III Transmission Limited (a 100% wholly owned subsidiary of Power Grid Corporation of India Limited)

**Bhadla III Transmission Limited**

(A 100% wholly owned subsidiary of Power Grid Corporation of India Limited)

Registered office: B-9, Qutab Institutional Area, Katwaria Sarai, New Delhi 110 016

Address for correspondence: C/o ED (TBCB), Power Grid Corporation of India Limited, Saudamini, Plot no.2, Sector -29, Gurgaon 122001

AND

Chief Operating Officer,  
Central Transmission Utility of India Ltd,  
Saudamini, Plot no.2, Sector -29,  
Gurgaon 122001.....

RESPONDENT(S)

And Others

Application

The Applicant respectfully submits as under:

1. The Government of India, Ministry of Power, vide Gazette notification CG-DL-E-08122021-231686 dated 06.12.2021 has notified PFC Consulting Limited (PFCCL) as the Bid Process Coordinator (hereinafter referred to as BPC) for the purpose of selection of Bidder as Transmission Service Provider (TSP) to establish Inter-State Transmission System for "Transmission system for evacuation of power from REZ in Rajasthan (20GW) under Phase-III Part B1" on build, own, operate and transfer basis. A copy of the notification is enclosed and marked as Annexure-1, (Page .....17... to Page .....21.....).



3/10..

The project consists of the following elements:

Sl. No.	Name of the Transmission Element	Scheduled COD in months from Effective Date	Percentage of Quoted Transmission Charges recoverable on Scheduled COD of the Element of the Project	Element(s) which are pre-required for declaring the commercial operation (COD) of the respective Element
1.	<p>Establishment of 2x1500 MVA 765/400kV &amp; 3x500 MVA 400/220 kV pooling station at Bhadla-3 along with 2x330 MVAR (765kV) Bus Reactor &amp; 2x125 MVAR (420kV) Bus Reactor</p> <ul style="list-style-type: none"> <li>· 765/400kV 1500 MVA ICTs: 2 nos. (7x500 MVA including one spare unit)</li> <li>· 765kV ICT bays - 2 nos.</li> <li>· 400/220 kV, 500 MVA ICT - 3 nos.</li> <li>· 765kV line bays - 2 nos.</li> <li>· 400 kV ICT bays - 5 nos.</li> <li>· 220 kV ICT bays - 3 nos.</li> <li>· 220 kV line bays: 5 nos.</li> <li>· 330 MVAR Bus Reactor-2 nos. (7x110 MVAR, including one spare unit)</li> <li>· 765kV reactor bay - 2 nos.</li> <li>· 125 MVAR, 420kV bus reactor - 2 nos.</li> <li>· 420 kV reactor bay - 2 nos.</li> </ul> <p>Future provisions:</p>	18 months	20.08%	Elements marked at Sl. No. 1, 2 & 3 are required to be commissioned simultaneously as their utilization is dependent on commissioning of each other.



*3/10..*

11



	<p>Space for</p> <ul style="list-style-type: none"> <li>· 765/400kV ICTs along with bays: 2 nos.</li> <li>· 765kV line bay along with switchable line reactor: 6 nos.</li> <li>· 765kV line bay: 4 nos.</li> <li>· 765kV Bus Reactor along with bays: 2 nos.</li> <li>· 400/220 kV ICTs along with bays: 10 nos.</li> <li>· 400 kV line bays: 8 nos.</li> <li>· 400 kV line bays along with switchable line reactor: 8 Nos.</li> <li>· 400kV Bus Reactor along with bays: 2 nos.</li> <li>· 400kV Sectionalization bay: 2 sets</li> <li>· 220 kV line bays: 12 nos.</li> <li>· 220kV sectionalization bay: 2 sets</li> </ul>			
2.	<p>Bhadla -3 PS – Sikar - II S/s 765 kV D/c line along with 330 MVAR Switchable line reactor for each circuit at each end of Bhadla -3 PS – Sikar -II S/s 765 kV D/c line</p> <ul style="list-style-type: none"> <li>· Switching equipment for 765 kV 330 MVAR switchable line reactor – 4 nos.</li> <li>· 765 kV, 330 MVAR Switchable line reactor - 4 nos.</li> </ul>		78.16%	
3.	<p>765 kV line bays at Sikar - II</p> <ul style="list-style-type: none"> <li>· 765 kV line bays – 2 nos.</li> </ul>		1.76%	

Note:

- i. Provision of suitable sectionalization shall be kept at Bhadla-3 at 400 kV & 220 kV level to limit short circuit level.

12



- ii. Developer of Sikar-II S/s to provide space for 2 nos. of 765 kV line bays at Sikar-II S/s along with space for switchable line reactors.
  - iii. Space provision for future 2 nos. 220kV Bus Coupler bay and 2 nos. Transfer Bus Coupler Bay shall be kept for bus switching scheme requirement.
2. That a company under the Companies Act 2013 by the name “**Bhadla III Transmission Limited**” having its registered office at New Delhi has been incorporated on 27.05.2022 by PFC Consulting Limited (PFCCL) as its wholly owned subsidiary to initiate the activities for execution of the Project and subsequently to act as Transmission Service Provider (TSP) after being acquired by the successful bidder selected through Tariff Based Competitive Bidding process. A copy of the Certificate of Incorporation is enclosed and marked as **Annexure-2, (Page ..22..... to Page ..22.....)** and a copy of the Memorandum of Association and Articles of Association is enclosed and marked as **Annexure-3, (Page ..23..... to Page ...6.1.....)**.
  3. BPC has initiated the selection of successful bidder to acquire the TSP in accordance with the “Tariff Based Competitive Bidding Guidelines for Transmission Service” and “Guidelines for Encouraging Competition in Development of Transmission Projects” issued by Government of India, Ministry of Power under section – 63 of The Electricity Act, 2003 and as amended from time to time. Copy of the Global Invitation for Qualification as published in the newspapers as furnished by BPC is enclosed and marked as **Annexure-4, (Page ..6.2... to Page ..6.4.....)**.
  4. That in the RFP documents, the following is stated  
Quote  
“The Transmission Charges shall be payable by the Designated ISTS Customers in Indian Rupees through the CTU as per Central Electricity Regulatory Commission (Sharing of Inter-State Transmission Charges and Losses) Regulations as amended from time to time.”  
Unquote  
Copy of the relevant extract of the RFP document issued by the BPC is enclosed and marked as **Annexure-5, (Page ..6.5.... to Page ..6.6.....)** which are integral part of the RFP bidding documents furnished by BPC for bidding.
  5. Subsequent to the process of competitive bidding conducted by the BPC, Power Grid Corporation of India Limited has been declared as the successful bidder. Copy of the Certificate by Bid Evaluation Committee report as furnished by BPC is enclosed and marked as **Annexure-6, (Page ...6.7.... to Page ..6.7.....)**. The Letter of Intent was issued to Power Grid Corporation of India Limited on 28.07.2023 by the BPC. A copy of the Letter of Intent (LoI) alongwith the details of Annual Transmission Charges is enclosed and marked as **Annexure-7, (Page ..6.8..... to Page ...7.1.....)**.



Bha.

6. As per the provisions 2.15.2 of Request for Proposal (RFP) and the Letter of Intent issued to Power Grid Corporation of India Limited, within 10 days of issuance of Letter of Intent by the BPC, the Successful Bidder is required to inter-alia provide the Contract Performance Guarantee, execute Share Purchase Agreement & the Transmission Service Agreement and acquire the SPV. Vide letter dated 27.09.2023, the BPC in terms of provisio Clause 2.15.2 of RFP has extended the date upto 27.09.2023 for completion of activities by the successful bidder. A copy of the relevant extract of the RFP and the letter from BPC is enclosed and marked as Annexure-8, (Page ...72.... to Page ...74.....).
7. That in accordance with the LoI, Power Grid Corporation of India Limited on 27.09.2023 furnished Contract Performance Guarantee of Rs 60 Crore (Rupees Sixty Crore Only) in favour of Central Transmission Utility of India Limited (CTUIL).
8. A copy of the Transmission Service Agreement (TSA) entered between and "Bhadla III Transmission Limited" is enclosed and marked as Annexure-9, (Page ...75.... to Page ...79.....).
9. That the BPC vide letter dated 06.06.2023 had intimated to the bidders that the Acquisition Price payable by the Selected Bidder for Acquisition of one hundred percent of equity shareholding of Bhadla III Transmission Limited along with all its related assets and liabilities as Rs.20,11,16,595/-. Subsequent to the bidding and during acquisition the BPC vide letter dated 18.09.2023 intimated the successful bidder - the applicant, the final Acquisition Price as Rs.20,11,16,595/- with the following break-up:

PFCCL Management Fees .....	Rs. 15,00,00,000/-
Goods and Service Tax on PFCCL Management Fees .....	Rs. 2,70,00,000/-
Other Administrative Expenses.....	Rs. 2,40,16,595/-
Share Capital .....	Rs. 1,00,000/-

-----  
**Total** **Rs. 20,11,16,595/-**  
 -----

The aforesaid acquisition price of Rs. 20,11,16,595/- has been paid on 27.09.2023 to the PFCCL.

A copy of the BPC letters dated 06.06.2023 and 18.09.2023 with regard to the Acquisition Price is enclosed and marked as Annexure - 10, (Page ...92. to Page ...96..).

14



10. Thereafter, Power Grid Corporation of India Limited has acquired the **Bhadla III Transmission Limited on 27.09.2023** after execution of the Share Purchase Agreement, Transmission Service Agreement and completing all procedural requirements specified in the RFP documents. A copy of the Share purchase agreement is enclosed and marked as **Annexure -11 (Page 297 to Page 313....)**.
11. The Applicant has mapped Nodal Agency i.e. on the e-portal of this Hon'ble Commission. The Applicant shall also send a copy of the present Application to the via e-mail. The Application has been hosted on the website and is accessible on [www.powergrid.in/subsidiaries](http://www.powergrid.in/subsidiaries) and a copy of the Application has also been marked to .
- That a copy of the Application has also been marked to BPC to enable submission of the requisite documents / information by BPC before this Hon'ble Commission regarding the Bidding process undertaken and thereby ensure processing of application
- That a copy of the Application has also been marked to beneficiaries of the Northern Region as party to the Petition based on the list of the beneficiaries furnished by the CTUIL.
12. That a copy of SLD of the transmission scheme is enclosed and marked as **Annexure -12 (Page 314.. to Page 314....)**.
13. That POWERGRID has acquired the TSP on 27.09.2023 and the same is effective date of the project as per provisions of TSA. The schedule construction period of the project is 18 months. As such Scheduled CoD of the project works out to be 27.03.2025.
14. That **Bhadla III Transmission Limited** hereby submits this application under Section 63 of the Electricity Act, 2003 for Adoption of Transmission Charges to establish the Project under build, own, operate and transfer basis, which has been determined through transparent process of competitive bidding in accordance with the guidelines issued by the Central Government.
15. It is submitted that Section 63 of the Electricity Act, 2003 empowers the Appropriate Commission for Adoption of Transmission Charges.

Keeping in view the above, Hon'ble Commission may kindly adopt the Transmission Charges with respect to the Transmission System being established by the **Bhadla III Transmission Limited (a 100% wholly owned subsidiary of Power Grid Corporation of India Limited)**.

15



Buo

## 16. PRAYER

The applicant hereby humbly prays the Hon'ble Commission to:

- a) Adoption of Transmission Charges for **Inter-State Transmission System for "Transmission system for evacuation of power from REZ in Rajasthan (20GW) under Phase-III Part B1"** discovered through competitive bidding process.
- b) Allow the sharing and recovery of Transmission Charges for **Inter-State Transmission System for "Transmission system for evacuation of power from REZ in Rajasthan (20GW) under Phase-III Part B1"** as per Sharing of Inter-state Transmission Charges and Losses CERC Regulations 2020 and any other amendment thereon issued from time to time by CERC.
- c) Pass such other order / orders, as may be deemed fit and proper in the facts and circumstances of the case.

**Bhadla III Transmission Limited**

**Applicant**

*310..*

**Represented by Upendra Singh  
Project Incharge, Bhadla III Transmission Limited**

**Place: New Delhi**

**Date: 27/09/2023**





**MINISTRY OF POWER**

**NOTIFICATION**

New Delhi, the 3rd December, 2021

**S.O. 5032(E).**—In exercise of the powers conferred by sub- para 3.2 of Para 3 of the Guidelines circulated under Section 63 of the Electricity Act, 2003 (no. 36 of 2003), the Central Government hereby appoints the following Bid-Process Coordinators (BPCs) for the Transmission Schemes, as shown against the name of the Transmission Schemes:

Sl. No.	Name & Scope of the Transmission Scheme	Bid Process Coordinator						
1.	<p><b>Transmission system for evacuation of power from Neemuch SEZ:</b></p> <p><b>Scope:</b></p> <table border="1" data-bbox="225 1671 1118 2022"> <thead> <tr> <th data-bbox="225 1671 304 1738">Sl. No</th> <th data-bbox="304 1671 759 1738">Scope of the Transmission Scheme</th> <th data-bbox="759 1671 1118 1738">Capacity /km</th> </tr> </thead> <tbody> <tr> <td data-bbox="225 1738 304 2022">1</td> <td data-bbox="304 1738 759 2022"> <p>Establishment of 2x500 MVA, 400/220 kV Pooling Station (AIS) at Neemuch with 1x125 MVAr Bus Reactor</p> <p>Future provisions: Space for 400/220 kV ICTs along with bays: 2</p> </td> <td data-bbox="759 1738 1118 2022"> <p>400/220 kV, 500 MVA ICT –2 nos.</p> <p>400 kV ICT bays – 2 nos.</p> <p>220 kV ICT bays – 2 nos.</p> <p>400 kV line bays (2 each for Chittorgarh &amp; Mandasaur</p> </td> </tr> </tbody> </table>	Sl. No	Scope of the Transmission Scheme	Capacity /km	1	<p>Establishment of 2x500 MVA, 400/220 kV Pooling Station (AIS) at Neemuch with 1x125 MVAr Bus Reactor</p> <p>Future provisions: Space for 400/220 kV ICTs along with bays: 2</p>	<p>400/220 kV, 500 MVA ICT –2 nos.</p> <p>400 kV ICT bays – 2 nos.</p> <p>220 kV ICT bays – 2 nos.</p> <p>400 kV line bays (2 each for Chittorgarh &amp; Mandasaur</p>	
Sl. No	Scope of the Transmission Scheme	Capacity /km						
1	<p>Establishment of 2x500 MVA, 400/220 kV Pooling Station (AIS) at Neemuch with 1x125 MVAr Bus Reactor</p> <p>Future provisions: Space for 400/220 kV ICTs along with bays: 2</p>	<p>400/220 kV, 500 MVA ICT –2 nos.</p> <p>400 kV ICT bays – 2 nos.</p> <p>220 kV ICT bays – 2 nos.</p> <p>400 kV line bays (2 each for Chittorgarh &amp; Mandasaur</p>						



*Attested from pg 17 to 21*

**ATTESTED TRUE COPY**

*2021*

**Authorised Signatory**  
**BHAOLA IN TRANSMISSION LIMITED**

	nos. 400 kV Sectionalization bay: 1 nos. 220 kV line bays: 10 nos. 220 kV sectionalization bay: 2 nos.	granted to RE developers (4 no. of bays considered at present). 125 MVAR, 420 kV bus reactor - 2 nos. 420 kV reactor bay - 2 nos.
2.	Fatehgarh-4- Fatehgarh-3 400 kV D/c twin HLTS* line (50 km)	Length - 50 km
3.	2 no. of 400 kV line bays at Fatehgarh- 3	400 kV line bays - 2 nos.

\* with minimum capacity of 2100 MVA on each circuit at nominal voltage

Note:

- Provision of suitable sectionalization shall be kept at Fatehgarh-4 at 400kV & 220kV level to limit short circuit level
- Developer of Fatehgarh-3 S/s(new section) to provide space for 2 nos. of 400 kV line bays at Fatehgarh-3 S/s for termination of Fatehgarh-4- Fatehgarh-3 400 kV D/c twin HLTS line
- The line lengths mentioned above are approximate as the exact length shall be obtained after the detailed survey
- Scheme to be awarded after SECI/REIA awards first bid of RE project at Fatehgarh-4 pooling station.

**Implementation Timeframe:** 18 months from date of SPV acquisition.

**6 Transmission system for evacuation of power from REZ in Rajasthan (20GW) under Phase-III Part A3**

Scope :

Sl. No.	Scope of the Transmission Scheme	Capacity /km
1.	Fatehgarh 3- Bhadla-3 400kV D/c line(Quad) along with 50 MVAR Switchable line reactor for each circuit at both ends of Fatehgarh 3- Bhadla-3 400kV D/c line	Length - 200 km 400 kV 50 MVAR Switchable line reactor - 4 nos. Switching equipment for 400 kV 50 MVAR switchable line reactor - 4 nos. 400 kV line bays Bhadla-3 S/s & Fatehgarh-3 S/s - 4 nos. (2+2)

Note:

- Fatehgarh 3- Bhadla-3 400 kV D/c line may be taken up for evacuation requirement beyond 2000 MW at Fatehgarh-4.
- Developer of Fatehgarh-3 S/s(new section) to provide space 2 nos. of 400 kV line bays along with space for switchable line reactors at Fatehgarh-3
- Developer of Bhadla -3 substation to provide space for 2 nos. of 400 kV line bays along with space for switchable line reactors at Bhadla -3

**Implementation Timeframe:** 18 months from date of SPV acquisition.

PFCCCL

**7 Transmission system for evacuation of power from REZ in Rajasthan (20GW) under Phase-III Part B1**

Scope:



Sl. No.	Scope of the Transmission Scheme	Capacity /km
1.	Establishment of 2x1500 MVA, 765/400kV & 3x500 MVA, 400/220 kV pooling station at Bhadla-3 along with 2x330 MVAR (765kV) Bus Reactor & 2x125 MVAR (420kV) Bus Reactor <u>Future provisions:</u> Space for 765/400kV ICTs along with bays: 2nos. 765kV line bay along with switchable line reactor: 4nos. 765kV line bay: 4nos. 765kV Bus Reactor along with bays: 2 nos. 400/220 kV ICTs along with bays: 10nos. 400 kV line bays: 8 nos. 400 kV line bays along with switchable line reactor:4 400 kV Bus Reactor along with bays: 2 nos. 400 kV Sectionalization bay: 2 nos. 220 kV line bays: 12 nos. 220 kV sectionalization bay: 2nos.	765/400kV 1500 MVA ICTs: 2 nos (7x500 MVA, including one spare unit) 765kV ICT bays - 2 nos. 400/220 kV, 500 MVA ICT - 3 nos. 765kV line bays - 2 nos. 400 kV ICT bays - 5 nos. 220 kV ICT bays - 3 nos. 400 kV line bays - 2 nos 220 kV line bays: As per connectivity granted to RE developers (5 no. of bays considered at present) 330 MVAR Bus Reactor-2 nos. (7x110 MVAR, including one spare unit) 765kV reactor bay- 2 nos. 125 MVAR, 420kV bus reactor - 2 nos. 420 kV reactor bay - 2 nos.
2.	Fatehgarh-2 – Bhadla-3 400 kV D/c line (Quad moose) along with 50 MVAR Switchable line reactor for each circuit at both ends of Fatehgarh 2- Bhadla-3 400 kV D/c line	Length – 200 km 400 kV 50 MVAR switchable line reactor –4 Switching equipment for 400 kV 50 MVAR switchable line reactor –4
3.	2 nos. of 400 kV line bays at Fatehgarh-2 for Fatehgarh-2 – Bhadla-3 400kV D/c line	400 kV line bays - 2 nos.
4.	Bhadla-3 – Sikar-II 765 kV D/c line along with 330 MVAR Switchable line reactor for each circuit at each end of Bhadla-3 – Sikar-II 765 kV D/c line	Length – 380km Switching equipment for 765 kV 330 MVAR switchable line reactor –4 765 kV, 330 MVAR Switchable line reactor- 4
5	2 nos. of 765 kV line bays at Sikar-II	765 kV line bays - 2nos

PFCCCL

Note:

- Scheme to be awarded after SECI/REIA awards first bid of RE project at Ramgarh PS/Bhadla-3 PS
- Provision of suitable sectionalization shall be kept at Bhadla-3 at 400kV & 220kV level to limit short circuit level
- Powergrid to provide space for 2 nos. of 400 kV line bays along with space for switchable line reactors at Fatehgarh-2 S/s
- The line lengths mentioned above are approximate, as the exact length shall be obtained after detailed survey.
- Developer of Sikar-II S/s to provide space for 2 nos. of 765 kV line bays at Sikar-



II S/s along with space for switchable line reactors Implementation Timeframe: 18 months from date of SPV acquisition.		
8 Transmission system for evacuation of power from REZ in Rajasthan (20GW) under Phase-III Part C1		
Scope :		
Sl. No.	Scope of the Transmission Scheme	Capacity /km
1.	Establishment of 2x1500 MVA, 765/400kV & 2x500 MVA, 400/220 kV pooling station at Ramgarh along with 2x240 MVA (765kV) Bus Reactor & 2x125 MVA (420kV) Bus reactor  <u>Future provisions:</u> Space for 765/400kV ICTs along with bays: 3nos. 765kV line bay along with switchable line reactor: 2nos. 765kV Bus Reactor along with bays: 2 nos. 400/220 kV ICTs along with bays: 6 nos. 400 kV line bays along with switchable line reactor: 4nos. 400 kV line bays: 4 nos. 400kV Bus Reactor along with bays: 2 nos. 400kV Sectionalization bay: 3 nos. 220 kV line bays: 8 nos. 220kV sectionalisation bay: 2 nos.	765/400kV 1500 MVA ICTs: 2 nos (7x500 MVA including one spare unit) 765kV ICT bays - 2 nos. 400/220 kV, 500 MVA ICT - 2nos. 400 kV ICT bays - 4 nos. 220 kV ICT bays - 2 nos. 400 kV line bays - As per connectivity granted to RE developers (2 no. of bays considered at present) 220 kV line bays - As per connectivity granted to RE developers (4 no. of bays considered at present) 765 kV line bays - 2 nos. 240 MVA Bus Reactor-2 nos. (7x80 MVA considering one spare unit) 765kV reactor bay- 2 nos. 125 MVA, 420kV bus reactor - 2 nos. 420 kV reactor bay - 2 nos.
2.	Ramgarh - Bhadla-3 765 kV D/c line (180 km) along with 240 MVA switchable line reactor at each circuit at Ramgarh end of Ramgarh - Bhadla-3 765kV D/c line	Length - 180km 765 kV, 240 MVA switchable line reactor- 2 nos Switching equipment for 765 kV 240 MVA switchable line reactor - 2 nos.
3.	2 nos. of 765kV line bays at Bhadla-3	765 kV line bays - 2nos
<b>Note:</b>		
i. Implementation schedule of Phase III -Part C1 package is to match with package Phase III -Part B1 (establishment of Bhadla-3 PS, 765kV Bhadla-3 PS-Sikar-2 D/c line, 400kV Bhadla-3 PS-Fatehgarh-2 D/c line)		
ii. Developer of Bhadla-3 S/s to provide space for 2 nos. of 765 kV line bays at Bhadla-3 S/s for termination of Ramgarh - Bhadla-3 765kV D/c line		
iii. The line lengths mentioned above are approximate as the exact length shall be obtained after the detailed survey		
iv. Provision of suitable sectionalization shall be kept at Ramgarh at 400kV & 220kV level to limit short circuit level		
v. Scheme to be awarded after SECI/RELA awards first bid of RE project at		

RECPDCL





Ramgarh PS/Bhadla-3 PS

**Implementation Timeframe:** 18 months from date of SPV acquisition.**9 Transmission system for evacuation of power from REZ in Rajasthan (20GW) under Phase-III Part D****Scope:**

Sl.No.	Scope of the Transmission Scheme	Capacity /km
1.	Sikar-II – Khetri 765 kV D/c line	Length – 90 km
2	Sikar-II – Narela 765 kV D/c line along with 240 MVAr Switchable line reactor for each circuit at each end of Sikar-II – Narela 765 kV D/c line	Length – 260 km Switching equipment for 765 kV 240 MVAR switchable line reactor –4 nos. 240 MVAr, 765kV Switchable line reactor- 4 nos.
3	Jhatikara – Dwarka 400kV D/c line (Quad) (20km)	Length – 20 km
4	765kV line bays at Sikar -II for Sikar-II – Khetri 765 kV D/c line and Sikar-II – Narela 765 kV D/c line	765 kV line bays - 4nos
5	2 nos. of 765kV line bays at both Khetri and Narela S/s	765 kV line bays - 4nos
6	2 nos. of 400kV line bays at both Jhatikara and Dwaraka S/s	400 kV line bays - 4nos

**Note:**

- Developer of Sikar-II S/s to provide space for 4 nos. of 765 kV line bays at Sikar-II S/s along with space for two nos. of switchable line reactors
- Developer of Narela S/s to provide space for 2 nos. of 765 kV line bays along with space for switchable line reactors at Narela S/s
- Powergrid to provide space for two nos. of 765 kV line bays at Khetri substation
- Powergrid and DTL to provide space for two nos. of 400kV line bays both at Jhatikara and Dwarka S/s respectively
- The line lengths mentioned above are approximate as the exact length shall be obtained after the detailed survey.
- Scheme to be implemented in matching time frame of Transmission system for evacuation of power from REZ in Rajasthan (20GW) under Phase-III Part C1

**Implementation Timeframe:** 18 months from date of SPV acquisition

RECPDCL

**10 Transmission system for evacuation of power from REZ in Rajasthan (20GW) under Phase-III Part F****Scope :**

Sl.No.	Scope of the Transmission Scheme	Capacity /km
1	Establishment of 2x1500MVA, 765/400kV Substation at suitable location near Beawar along with 2x330 MVAr 765kV Bus Reactor & 2x125 MVAr 420kV Bus Reactor <u>Future provisions:</u> Space for 765/400kV ICTs along with bays:2 nos.	765/400kV 1500 MVA ICTs: 2 nos (7x500 MVA, including one spare unit) 330 MVAr, 765 kV bus reactor- 2 (7x110 MVAr, including one





सत्यमेव जयते

GOVERNMENT OF INDIA  
MINISTRY OF CORPORATE AFFAIRS

Central Registration Centre

## Certificate of Incorporation

[Pursuant to sub-section (2) of section 7 and sub-section (1) of section 8 of the Companies Act, 2013 (18 of 2013) and rule 18 of the Companies (Incorporation) Rules, 2014]

I hereby certify that BHADLA III TRANSMISSION LIMITED is incorporated on this Twenty seventh day of May Two thousand twenty-two under the Companies Act, 2013 (18 of 2013) and that the company is limited by shares.

The Corporate Identity Number of the company is U74999DL2022GOI399208.

The Permanent Account Number (PAN) of the company is **AAKCB7906R** \*

The Tax Deduction and Collection Account Number (TAN) of the company is **DELB25235A** \*

Given under my hand at Manesar this Twenty seventh day of May Two thousand twenty-two .



Digital Signature Certificate  
KAMAL HARJANI

For and on behalf of the Jurisdictional Registrar of Companies  
Registrar of Companies  
Central Registration Centre

Disclaimer: This certificate only evidences incorporation of the company on the basis of documents and declarations of the applicant(s). This certificate is neither a license nor permission to conduct business or solicit deposits or funds from public. Permission of sector regulator is necessary wherever required. Registration status and other details of the company can be verified on [www.mca.gov.in](http://www.mca.gov.in)

Mailing Address as per record available in Registrar of Companies office:

BHADLA III TRANSMISSION LIMITED

Urjanidhi, First Floor, 1, Barakhamba Lane, Connaught Place, NewDelhi,  
Central Delhi, Delhi, India, 110001



\* as issued by the Income Tax Department



210..

22

[Pursuant to Schedule I (see sections 4 and 5) to the Companies Act, 2013] FORM NO. INC-33

**SPICE+MOA**  
(e-Memorandum of Association)

\* Table applicable to company as notified under schedule I of the companies Act, 2013

A

**Table A- MEMORANDUM OF ASSOCIATION OF A COMPANY LIMITED BY SHARES**

1. The Name of the Company is

BHADLA III TRANSMISSION LIMITED

2. The Registered office of the company will be situated in the state of

Delhi-DL

3.(a) The objects to be pursued by the company on its incorporation are

1. To develop Power System Network  
To plan, promote and develop an integrated and efficient power transmission system network in all its aspects including planning, investigation, research, design and engineering, preparation of preliminary, feasibility and definite project reports, construction, operation and maintenance of transmission lines, sub-stations, load dispatch stations and communication facilities and appurtenant works, coordination of integrated operation of state, regional and national grid system, execution of turn-key jobs for other utilities/organizations and wheeling of power in accordance with the policies, guidelines and objectives laid down by the Central Government from time to time.
2. To study, investigate, collect information and data  
To study, investigate, collect information and data, review operation, plan, research, design and prepare Report, diagnose operational difficulties and weaknesses and advise on the remedial measures to improve, undertake development of new and innovative product connected with business of the Company as well as modernize existing EHV, HV lines and Sub-Station.
3. To act as Consultants/ Technical Advisers of public/ private sector enterprises etc.  
To act as consultants, technical advisors, surveyors and providers of technical and other services to Public or Private Sector enterprises engaged in the planning, investigation, research, design and preparations of preliminary, feasibility and definite project reports, manufacture of power plant and equipment, construction, generation, operation and maintenance of power transmission system from power generating stations and projects, transmission, distribution and sale of power

3.(b) Matters which are necessary for furtherance of the objects specified in clause 3(a) are

1. To obtain authority etc. to carry out its objects  
To obtain license, approvals and authorization from Governmental Statutory and Regulatory Authorities, as may be necessary to carry out and achieve the Objects of the Company and connected matters which may seem expedient to develop the business interests of the Company in India and abroad.
2. To obtain charters, concession etc.  
To enter into any arrangement with the Government of India or with any State Government or with other authorities/ commissions, local bodies or public sector or private sector undertakings, Power Utilities, Financial Institutions, Banks, International Funding Agencies and obtain such charters, subsidies, loans, advances or other money, grants, contracts, rights, sanctions, privileges, licenses or concessions whatsoever (whether statutory or otherwise) which the Company may think it desirable to obtain for carrying its activities in furthering the interests of the Company or its members
3. To enter into Implementation/ Construction Agreement  
To enter into any agreement, contract or any arrangement for the implementation of the power generation, evacuation, transmission and distribution system and network with Power/Transmission Utilities, State Electricity Boards, Vidyut Boards, Transmission Companies, Generation Companies, Licensees, Statutory bodies, other organizations (whether in Private, Public or Joint Sector Undertaking) and bulk consumers of power etc.
4. To carry on the business or purchasing, importing, exporting and trading power  
To carry on the business or purchasing, importing, exporting and trading of power subject to the provisions of Electricity Act, 2003 and to



Attested from Pg 23 to 28

2010..

Authorised Signatory  
BHADLA III TRANSMISSION LIMITED

supply electric power generated by other plants to distribution companies, trading companies, other generation companies and other Persons, and in this regard execute agreements with Central and State generating authorities, departments or companies, Independent Power Producers and other Persons.

5. To enter into Agreements; etc.

To secure the payments of money, receivables on transmission and distribution of electricity and sale of fuel, as the case may be, to the State Electricity Boards, Vidyut Boards, Transmission Utilities, Generating Companies, Transmission Companies, Distribution Companies, State Governments, Licensees, statutory bodies, other organizations (whether in Private, Public or Joint Sector Undertaking) and bulk consumers of power etc. through Letter of Credits/ESCROW and other security documents.

6. To execute transmission service Agreements

To execute Transmission Service Agreements or other agreements for transmission of power to distribution, trading, and other companies, State Electricity Boards, State Utilities and any other organization and Persons.

7. To co-ordinate with Central Transmission Utility

To coordinate with the Central Transmission Utility for transmission of electricity under the provisions of Electricity Act 2003.

8. To borrow money

Subject to provisions of Sections 73, 179, 180 and other applicable provisions of the Companies Act, 2013 and subject to other laws or directives, if any, of SEBI/RBI, to borrow money in Indian rupees or foreign currencies and obtain foreign lines of credits/ grants/aids etc. or to receive money or deposits from public for the purpose of the Company's business in such manner and on such terms and with such rights, privileges and obligations as the Company may think fit. The Company may issue bonds/ debentures whether secured or unsecured; bills of exchange, promissory notes or other securities, mortgage or charge on all or any of the immovable and movable properties, present or future and all or any of the uncalled capital for the time being of the Company as the Company may deem fit and to repay, redeem or pay off any such securities or charges.

9. To lend money

To lend money on property or on mortgage of immovable properties or against Bank guarantee and to make advances of money against future supply of goods and services on such terms as the Directors may consider necessary and to invest money of the Company in such manner as the Directors may think fit and to sell, transfer or to deal with the same.

10. To acquire, own, lease or dispose off the property

To own, possess, acquire by purchase, lease or otherwise rights, title and interests in and to, exchange or hire real estate, equipment, Transmission lines, lands, buildings, apartments, plants, equipment, machinery, fuel blocks and hereditaments of any tenure or descriptions situated in India or abroad or any estate or interest therein and any right over or connected with land so situated and turn the same to account in any manner as may seem necessary or convenient for the purpose of business of the Company and to hold, improve, exploit, re-organize, manage, lease, sell, exchange or otherwise dispose of the whole or any part thereof.

11. To deal in Scrips/Govt. Securities

Subject to applicable provisions of law, to subscribe for, underwrite, or otherwise acquire, hold, dispose of and deal with the shares, stocks, debentures or other securities and titles of indebtedness or the right to participate in profits or other similar documents issued by any Government authority, Corporation or body or by any company or body of persons and any option or right in respect thereof.

12. To create funds and appropriate profits

To create any depreciation fund, reserve fund, sinking fund, insurance fund, gratuity, provident fund or any other fund, for depreciation or for repairing, improving extending or maintaining any of the properties of the Company or for any other purposes whatsoever conducive to the interests of the Company.

13. To purchase or otherwise acquire companies

To acquire shares, stocks, debentures or securities of any company carrying on any business which this Company is entitled to carry on or acquisition of undertaking itself which may seem likely or calculated to promote or advance the interests of the Company and to sell or dispose of or transfer any such shares, stocks or securities and the acquired undertaking.

14. To enter into partnership Agreement or Merge /amalgamate

To enter into partnership or into any agreement for joint working, sharing or pooling profits, joint venture, amalgamation, union of interests, co-operation, reciprocal concessions or otherwise or amalgamate with any person or company carrying on or engaged in or about to carry on or engaged in any business or transaction in India or abroad which the Company is authorized to carry on or engage in any business undertaking having objects identical or similar to, as are being carried on by this Company.

15. To have agencies and branch offices in India and abroad

To establish and maintain agencies, branch offices and local agencies, to procure business in any part of India and world and to take such steps as may be necessary to give the Company such rights and privileges in any part of the world as deemed proper in the interest of the Company.

16. To promote institutions or other companies

To promote and undertake the formation of any institution or Company or subsidiary company or for any aforesaid objects intended to benefit the Company directly or indirectly and to coordinate, control and guide their activities.

17(a) To acquire know how and import-export of machinery and tools etc.

To negotiate and enter into agreements and contracts with domestic and foreign companies, persons or other organizations, banks and financial institutions, in relation to the business of the Company including that of technical know-how, import, export, purchase or sale of plant, machinery, equipment, tools, accessories and consumables, financial assistance and for carrying out all or any of the objects of the Company.

17(b) To negotiate and enter into agreements etc

To negotiate and enter into agreements and contracts for execution of turnkey jobs, works, supplies and export of plant, machinery, tools and accessories etc.

18. To enter into contracts/arrangements in connection with issue of shares/securities.

Upon and for the purpose of any issue of shares, debentures or any other securities of the Company, to enter into agreement with intermediaries including brokers, managers of issue/commission agents and underwriters and to provide for the remuneration of such persons for their services by way of payment in cash or issue of shares, debentures or other securities of the Company or by granting options to take the same or in any other manner as permissible under the law.

19. To enter into contracts of indemnity and/or guarantee

To enter into contracts of indemnity and get guarantee and allocations for the business of the Company.

20. To arrange for Training and Development





To make arrangements for training of all categories of employees and to employ or otherwise engage experts, advisors, consultants etc. in the interest of achieving the Company's objects.

21. To promote conservation, protect environment, theft etc.

To promote conservation and protection of electricity from theft, safety of life and to protect environments including air, land and water etc.

22. To provide for welfare of employees

To pay and provide for the remuneration, amelioration and welfare of persons employed or formerly employed by the Company and their families providing for pension, allowances, bonuses, other payments or by creating for the purpose from time to time the Provident Fund, Gratuity and other Funds or Trusts. Further to undertake building or contributing to the building or houses, dwellings or chawls by grants of money, or by helping persons employed by the Company to effect or maintain insurance on their lives by contributing to the payment of premium or otherwise and by providing or subscribing or contributing towards educational institutions, recreation, hospitals and dispensaries, medical and other assistance as the Company may deem fit.

23. To take Insurance

To ensure any rights, properties, undertakings, contracts, guarantees or obligations or profits of the Company of every nature and kind in any manner with any person, firm, association, institution or company.

24. To share the profits pay, dividends and provide bonus etc

To distribute among members of the Company dividend including bonus shares out of profits, accumulated profits or funds and resources of the Company in any manner permissible under law.

25. To institute and defend the legal proceedings

To institute, conduct, defend, compound or abandon any legal proceedings by or against the Company or its officers or otherwise concerning the affairs of the Company and also to compound and to allow time for payment or satisfaction of any debts or recovery due, claims or demands by or against the Company and to refer any claims or demands by or against the Company or any differences arising in execution of contracts to conciliation and arbitration and to observe, comply with and/or challenge any awards preliminary, interim or final made in any such arbitration.

26. To pay and subsequently write off preliminary expenses

To pay out of the funds of the Company all costs, charges, expenses and preliminary and incidental to the promotion, formation, establishment and registration of the Company or other expenses incurred in this regard.

27. To contribute and make donations

Subject to provisions of Companies Act, 2013 to contribute money or otherwise assist to charitable, benevolent, religious, scientific national, defense, public or other institutions or objects or purposes.

28. To open accounts in Banks

To open an account or accounts with any individual, firm or company or with any bank bankers or shrofs and to pay into and withdraw money from such account or accounts.

29. To accept gifts, donations etc.

To accept gifts, bequests, devises and donations from members and others and to make gifts to members and others of money, assets and properties of any kind.

30. To pursue the objects of the Company as principal, agents, trustee or in any other capacity

To carry out all or any of the objects of the company and do all or any of the above things in any part of the world and either as principal, agent, contractor or trustee or otherwise and either alone or in conjunction with others.

31. To enter into Contracts

To negotiate and/or enter into agreement and contract with individuals, companies, corporations, foreign or Indian, for obtaining or providing technical, financial or any other assistance for carrying on all or any of the objects of the Company and also for the purpose of activating, research, development of projects on the basis of know-how and/or financial participation and for technical collaboration, and to acquire or provide necessary formulate and patent rights for furthering the objects of the company.

32. To contribute towards promotion of trade and industry

To aid pecuniary or otherwise, any association, body or movement having for its object the solution, settlement or surmounting of industrial or labour problems or trouble or the promotion of industry or trade.

33. To take all necessary steps for winding up of the company

Subject to the provisions of Companies Act, 2013 or any amendment or re-enactment thereof in the event of winding up to distribute among the members in specie any property of the Company or any proceeds of sale on disposal of any property in accordance with the provisions of the Act.

34. To do and perform all coincidental and ancillary acts for the attainment of its objects

To do all such other things as may be deemed incidental or conducive to the attainment of the above Objects or any of them and to carry on any business which may seem to the Company capable of being conveniently carried in connection with any of the Company's Objects or calculated directly or indirectly to enhance the value of or render profitable any of the Company's property or rights.

35. To take up studies and research experiments

To establish, provide, maintain and conduct or otherwise subsidies research laboratories and experimental workshops for scientific, technical or researches, experiments and to undertake and carry on directly or in collaboration with other agencies scientific and technical research experiments and tests of all kinds and to process, improve and invent new products and their techniques of manufacture and to promote, encourage, reward in every manner studies and research, scientific and technical investigations and inventions of any kind that may be considered likely to assist, encourage and promote rapid advances in technology, economies, import substitution or any business which the Company is authorized to carry on.

36. To evolve scheme for restructuring or arrangement.

Subject to provisions of the Companies Act, 2013, to evolve scheme for restructuring or arrangement, to amalgamate or merge or to enter into partnership or into any consortium or arrangement for sharing of profits, union of interests, co-operation, joint venture with any Person or Persons, partnership firm/firms, or company or companies carrying on or engaged in any operation capable of being conducted so conveniently in co-operation with the business of the Company or to benefit the Company or to the activities for which the Company has been established.

37. To apply for purchase, or otherwise acquire.

To apply for purchase, or otherwise acquire any trademarks, patents, brevets, inventions, licenses, concessions and the like, conferring any exclusive or nonexclusive or limited rights to use, or any secret or other information as to any invention which may be capable of being used for any of the purposes of the Company, or the acquisition of which may benefit the Company and to use, exercise, develop or grant

25



licenses in respect of or otherwise turn to account the property, rights or information so acquired.

38. To sell, dispose or hive off an undertaking of the Company  
 To sell, dispose or hive off an undertaking of the Company or any part thereof for such consideration as the Company may think fit and in particular for shares, debentures or securities of any other association, corporation or company.

39. To sell, improve, manage, develop  
 To sell, improve, manage, develop, exchange, loan, lease or let, under-lease, sub - let, mortgage, dispose of, deal with in any manner, turn to account or otherwise deal with any rights or property of the Company.

40. To outsource parts of its activities  
 To outsource parts of its activities to achieve higher efficiencies and throughputs in the achievement of its business goals.

4. The liability of the member(s) is limited and this liability is limited to the amount unpaid, if any, on the shares held by them.

5. The share capital of the company is 100,000.00 rupees, divided into,

10,000.00	Equity	shares of	10.00	rupees each	,and
-----------	--------	-----------	-------	-------------	------

- 6  We, the several persons, whose names and addresses are subscribed, are desirous of being formed into a company in pursuance of this memorandum of association, and we respectively agree to take the number of shares in the capital of the company set against our respective names:
- I, whose name and address is given below, am desirous of forming a company in pursuance of this memorandum of association and agree to take all the shares in the capital of the company (Applicable in case of one person company):



S.No.	Subscriber Details					
	Name, Address, Description and Occupation	DIN/PAN/Passport Number	No. of shares taken	DSC	Dated	
1	PFC Consulting Limited, having its Registered office at First floor, Urjanidhi, 1 Barakhamba Lane, Cannought Place ND 110001, through Sh. Manish Kumar Agarwal, S/o Shri Narender Agarwal, R/o A-3/905, Krishna Apra Garden, Vaibhav khand, Indirapuram, Ghaziabad, Uttar Pradesh 201014 Occupation Service (As Authorised Signatory of PFC Consulting Limited)	AIEPK3387Q	9,400	Equity	MANISH KUMAR AGARWAL Digitally signed by MANISH KUMAR AGARWAL Date: 2022.05.24 12:03:02 +05'30'	24/05/22
				Preference		
2	Manoj Kumar Rana R/o A-32/E, DDA Flats, Munirka ND 110067 (As a Nominee of PFC Consulting Limited) Occupation: Service	02263302	100	Equity	MANOJ KUMAR RANA Digitally signed by MANOJ KUMAR RANA Date: 2022.05.24 12:34:07 +05'30'	24/05/22
				Preference		
3	Dharuman Manavalan R/o A-703, Saheta Apartment, Plot No-30, Dwarka, Sector-4 ND 110078 (As a Nominee of PFC Consulting Limited) Occupation: Service	08102722	100	Equity	D Manavalan Digitally signed by D Manavalan Date: 2022.05.24 12:05:13 +05'30'	24/05/22
				Preference		
4	Milind Madhusudan Dafade R/o Flat C-31, Aishwarya M Aptt. Sector-4 Plot No. 17 Dwarka ND 110078 (As a Nominee of PFC Consulting Limited) Occupation: Service	09587967	100	Equity	MILIND MADHU SUDAN DAFADE Digitally signed by MILIND MADHU SUDAN DAFADE Date: 2022.05.24 12:35:44 +05'30'	24/05/22
				Preference		
5	Neeraj Singh R/o C-703, F-2, The Crescent Apartment, Sec-50, Noida, Gautam Budha Nagar, UP 201301 (As a Nominee of PFC Consulting Limited) Occupation: Service	08613892	100	Equity	Neeraj Singh Digitally signed by Neeraj Singh Date: 2022.05.24 17:10:18 +05'30'	24/05/22
				Preference		
6	Sanjay Nayak, R/o K-713, Jalvayu Tower, Sec-56, Gurgaon, Haryana, 122011 (As a Nominee of PFC Consulting Limited) Occupation: Service	08197193	100	Equity	SANJAY KUMAR NAYAK Digitally signed by SANJAY KUMAR NAYAK Date: 2022.05.24 12:37:01 +05'30'	24/05/22
				Preference		
7	Sachin Shukla, R/o C 5/804 PWO Complex Sec-43, Galleria, DLF-IV, Gurgaon 122009 (As a Nominee of PFC Consulting Limited) Occupation: Service	08613963	100	Equity	Sachin Shukla Digitally signed by Sachin Shukla Date: 2022.05.24 12:38:20 +05'30'	24/05/22
				Preference		
Total Shares taken			10,000.0	Equity		
				Preference		

Signed before Me

Name	Address, Description and Occupation	DIN/PAN/Passport Number/ Membership Number	DSC	Dated
------	-------------------------------------	---	-----	-------



27

FCS	Naresh Kumar Sinha	121, Vinayak Apartment C58/19, Sector-62, Noida-201307, UP	1807	NARE SH KUMA R SINHA <small>Digitally signed by NARESH KUMAR SINHA Date: 2022.05.24 18:04:23 +05'30'</small>	24/05/22
-----	--------------------	---	------	---	----------

Modify

Check Form



28

[Pursuant to Schedule I (see Sections 4 and 5) to the Companies Act, 2013)] FORM NO. INC-34

**SPICE+ AOA**  
(e-Articles of Association)

\*Table  F  as notified under schedule I of the companies Act, 2013 is applicable to the company

BHADLA III TRANSMISSION LIMITED

A COMPANY LIMITED BY SHARES

Check if not applicable	Check if altered	Article No	Description
			<i>Interpretation</i>
<input type="checkbox"/>	<input checked="" type="checkbox"/>		<p>In the interpretation of these Articles, unless repugnant to the subject or context:-</p> <p><b>Act</b> The Act means The Companies Act, 2013 as amended from time to time and includes any statutory modification or re-enactment thereof for the time being in force.</p> <p><b>Articles of the Company</b> Articles means the articles of association of a company as originally framed or as altered from time to time or applied in pursuance of any previous company law or of this Act.</p> <p><b>Auditor(s)</b> Auditor(s) mean and include persons appointed as such for the time being by the Comptroller &amp; Auditor General of India.</p> <p><b>Board or Board of Directors</b> Board or Board of Directors, in relation to a company, means the collective body of the directors of the company.</p> <p><b>Books of Account</b> Books of account includes records maintained in respect of (i) all sums of money received and expended by a company and matters in relation to which the receipts and expenditure take place; (ii) all sales and purchases of goods and services by the company; (iii) the assets and liabilities of the company; and (iv) the items of cost as may be prescribed under section 148 in the case of a company which belongs to any class of companies specified under that section.</p> <p><b>Capital</b> Capital means the share capital for the time being raised or authorized to be raised for the purpose of the Company.</p> <p><b>Company</b> Shall means BHADLA III TRANSMISSION LIMITED.</p> <p><b>Debenture</b> Debenture includes debenture stock, bonds or any other instrument of a company evidencing a debt, whether constituting a charge on the assets of the company or not.</p> <p><b>Director(s)</b> Director means a director appointed to the Board of a company under Section 2(34) of the Act.</p> <p><b>Dividend</b> Dividend includes any interim dividend.</p> <p><b>Financial Institution</b> Financial Institution includes a scheduled bank, and any other financial institution defined or notified under the Reserve Bank of India Act, 1934.</p> <p><b>Gender</b> Words importing the masculine gender also include the feminine gender.</p> <p><b>Generation Company</b> Generation Company shall mean any entity engaged in the business of generation of electricity</p> <p>In Writing and Written</p>



Attested from 19/29 to 6/1

**ATTESTED TRUE COPY**

30  
Authorized Signatory  
BHADLA III TRANSMISSION LIMITED

29



In writing and Written include printing, lithography and other modes of representing or reproducing words in a visible form.

key managerial personnel

key managerial personnel, in relation to a company, means

(i) the Chief Executive Officer or the managing director or the manager;

(ii) the company secretary;

(iii) the whole-time director;

(iv) the Chief Financial Officer; and

(v) such other officer as may be prescribed.

Meeting or General Meeting

Meeting means Annual General Meeting or Extraordinary General Meeting of Members duly called and constituted including an adjourned meeting. In the context of Board of Directors, it shall mean the meeting of the Directors including an adjourned meeting.

Member

Member, in relation to a company, means

(i) the subscriber to the memorandum of the company who shall be deemed to have agreed to become member of the company, and on its registration, shall be entered as member in its register of members;

(ii) every other person who agrees in writing to become a member of the company and whose name is entered in the register of members of the company;

(iii) every person holding shares of the company and whose name is entered as a beneficial owner in the records of a depository.

Month

Month means a calendar month.

Office

Office means the Registered Office of the company for the time being.

paid-up share capital or share capital paid-up means

such aggregate amount of money credited as paid-up as is equivalent to the amount received as paid up in respect of shares issued and also includes any amount credited as paid-up in respect of shares of the company, but does not include any other amount received in respect of such shares, by whatever name called;

Persons

Persons include Corporations and firms as well as individuals.

Power/Transmission Utility

Power / Transmission Utility shall mean any entity engaged in the business of power / transmission.

Proxy

Proxy includes Attorney duly constituted under a valid Power of Attorney.

Project-In-Charge

A Director of the Company designated as Project In-charge for administrating day to day activities of the Company.

Public Company

"Public Company" means a company which?

a. is not a private company and

b. has a minimum paid-up share capital as may be prescribed

Provided that a company which is a subsidiary of a company, not being a private company, shall be deemed to be public company for the purposes of this Act even where such subsidiary company continues to be a private company in its articles ;

Registrar

Registrar means a Registrar, an Additional Registrar, a Joint Registrar, a Deputy Registrar or an Assistant Registrar, having the duty of registering companies and discharging various functions under this Act.

Register of Members

Register of Members means the Register of Members to be kept pursuant to the Act.

Related Party

Section 2(76) of the Act describes related party, with reference to a company, which means?

(i) a director or his relative;

(ii) a key managerial personnel or his relative;

(iii) a firm, in which a director, manager or his relative is a partner;

(iv) a private company in which a director or manager is a member or director;

(v) a public company in which a director or manager is a director or holds along with his relatives, more than two per cent. of its paid-up share capital;

(vi) any body corporate whose Board of Directors, managing director or manager is accustomed to act in accordance with the advice, directions or instructions of a director or manager;

(vii) any person on whose advice, directions or instructions a director or manager is accustomed to act;



Provided that nothing in sub-clauses (vi) and (vii) shall apply to the advice, directions or instructions given in a professional capacity;  
(viii) any company which is  
(A) a holding, subsidiary or an associate company of such company; or  
(B) a subsidiary of a holding company to which it is also a subsidiary;  
(ix) such other person as may be prescribed.

**Seal**

Means the common seal of the company for the time being.

**Securities Exchange Board**

Securities and Exchange Board means the Securities and Exchange Board of India established under section 3 of the Securities & Exchange Board of India Act, 1992.

**Securities**

Securities means the securities as defined in clause (h) of section 2 of the Securities Contracts (Regulation) Act, 1956.

**Share**

Means a share in the share capital of a company and includes stock.

**Share Capital**

Share Capital means the total equity share capital of the Company agreed to be issued and called the "Authorized Capital" of the Company, as mentioned in the Memorandum of Association of the Company.

**Singular Number**

Words importing the singular number include, where the context admits the plural number and vice-versa.

**State Electricity Board**

State Electricity Board means the Electricity Board or Vidyut Board or any other body by whatever name called, set up by the State Governments under Electricity (Supply) Act 1948, as amended, which expression shall include its successors, administrators, authorized representatives and permitted assigns.

**Transmission Company**

Transmission Company shall mean any entity engaged in the business of transmission of electricity.  
**Year or Financial Year**

**Meaning of Words** Year means English calendar year and Financial Year shall have the meaning assigned thereto by Section 2(41) of the Act.

Unless the context otherwise requires, words or expressions contained in these regulations shall bear the same meaning as in the Act or any statutory modification thereof in force at the date at which these regulations become binding on the company.

**Marginal Notes**

Marginal Notes are for ease of reference only and shall not affect the construction and interpretation of these Articles.

**Other Expressions**

Other words or expressions contained in these Articles shall bear the same meaning as are assigned to them in the Act or any statutory modifications thereof.

**2. Table F not to Apply**

The regulations contained in Table F in the First Schedule to the Companies Act, 2013, shall not apply except to the extent that the same are repeated or contained or expressly made applicable by these Articles or by the Act but the regulations for the management of the Company and for the observance of the members thereof and their representatives shall, subject to any exercise of the statutory powers of the Company with reference to the repeal or alteration of, or addition to its regulations by Special Resolution, as prescribed by the said Companies Act, 2013 be such as contained in these Articles.

**BUSINESS PURPOSE**

**3 Business Purpose**

The Company shall be engaged in the business of Transmission of Electricity, including construction, operation, maintenance and other related activities.



**Share capital and variation of rights**

4 Share Capital / Increase of capital by the Company and how carried into effect

The Authorized Share Capital of the Company is as mentioned in clause V of the Memorandum of Association of the Company. The Company in General Meeting may from time to time, by resolution, increase its authorized share capital by creation of new shares, such increase to be of such aggregate amount and to be divided into shares of such respective amounts as may be determined by the General Meeting subject to the provisions of the Act.

5 New Capital same as existing capital

Any capital raised by the creation of new shares shall be considered as part of the original capital, and shall be subject to the same provisions herein contained, with reference to the payment of calls and installments, forfeiture, lien, surrender, transfer and transmission, voting and otherwise.

6 Reduction of Capital

The Company may, from time to time, by special resolution reduce its capital, which may be paid off either with or without extinguishing or reducing liability on shares, which is in excess of the wants of the company or canceling such share capital which has been lost or is unrepresented by available assets.

7 Subdivision and consolidation of shares

The Company in general meeting may, from time to time, sub-divide or consolidate its shares or any of them and exercise any of the other powers conferred by Section 61 of the Act and shall file with the Registrar such notice of exercise of any such powers as may be required by the Act.

8 Register and Index of Members/ Beneficial owners

The Company shall cause to be kept a Register and also an Index of Members and Debenture-holders in accordance with Sections 88 of the Act. Further, as permissible under Section 88 of the Act, the register and Index of beneficial owners maintained by a Depository shall be deemed to be the corresponding Register and Index for the purpose of this Act.

9 Foreign Register of members

The Company shall be entitled to keep in any country outside India a Foreign Register of members resident in that country, subject to compliance with the provisions of Section 88 of the Act.

10 Shares to be numbered distinctively

The shares in the capital held otherwise than in the depository mode shall be numbered progressively in sequence and given distinctive number, Except and in the manner herein mentioned, no share shall be forfeited or surrendered and shall continue to bear the number which it had originally borne.

11 Share Application Money

The Company shall ensure that the share application money paid is held by it in an account with a Scheduled Commercial Bank (in the name of the Company)

12 Further Issue of Capital

(a) Where at any time the Company wishes to raise its subscribed share capital by issue of further shares, it shall first offer such shares to its existing shareholders in proportion to their existing shareholdings on the date of such issue. Such offer to the existing shareholders shall be in accordance with the provisions of Section 62 of the Act.

(b) The Company shall subject to applicable provisions of the Act and Articles of Association, make uniform calls from time to time upon all the Shareholders in respect of the moneys remaining unpaid on the issued share capital within 30 days or such time, as the Board may deem fit and appropriate.

13 Shares under control of Directors

Subject to the provisions of these Articles and of the Act, the shares including any shares forming part of any increased capital of the Company shall be under the control of the Directors, who may allot or otherwise dispose off the shares to such persons in such proportion, on such terms and conditions and at such times as the Directors may think fit and subject to the sanction of the Company in General Meeting, subject to the provisions of Sections 52 and section 54 of the Act at a premium or par and such option being exercisable for such time and for such consideration as the Directors think fit. The Board shall cause to be filed the returns as to allotment provided for in Section 39(4) of the Act.

14 Issue of shares for consideration other than cash

Subject to these Articles and the provisions of the Act, if any, the Board may issue and allot shares in the capital of the Company as payment or in consideration or as part payment or in part consideration of the purchase or acquisition of any property or for services, rendered to the Company in the conduct of its business and shares which may be so issued or allotted shall be credited or deemed to be credited as fully paid up or partly paid up shares.

15 Power of Company to Issue Shares

The Company in General Meeting may subject to the provisions of Section 42 & 62 of the Act provide that any shares (whether forming part of the original capital or of any increased capital of the Company) shall be offered to such persons (whether a Member or not), in such proportion and on such terms and conditions of



32

the Act) at a premium or at par or at a discount, as such General Meeting shall determine and with full power to give any person (whether a Member or not) the option to call for or be allotted shares of any class of the Company either subject to compliance with the provisions of Sections 52 and 54 of the Act at a premium or at par or at discount, such option being exercisable at such times and for such consideration as may be directed by such General Meeting or the Company in General Meeting may make any other provisions whatsoever for the issue, allotment or disposal of any shares.

16 Acceptance of shares

Any person applying for shares in the Company followed by an allotment of any shares and subscribers to the Memorandum, shall be a shareholder within the meaning of these Articles, and every person whose name is on the Register of Members shall, for the purposes of these Articles, be a Member of the Company.

17 Deposit & call to be a debt payable Immediately

The Money, (if any), which the Board shall, on the application for allotment of any shares being made by them, require or direct to be paid by way of deposit, call or otherwise, in respect of any shares allotted by them, shall immediately on the insertion of the name of the allottee in the Register of Members as the name of the holder of such shares, become a debt due to and recoverable by the Company from the allottee thereof, and shall be paid by him accordingly.

18 Liability of Members

Every Member, or his heirs, executors or administrators, shall pay to the Company the portion of the capital and premium, if any, represented by or payable on, his share or shares which may, for the time being, remain unpaid thereon, in such amounts, at such time or times and in such manner as the Board shall, from time to time, in accordance with the Company's regulations, require or fix for the payment thereof.

19 Share Certificates

A certificate, issued under the common seal of the company, specifying the shares held by any person, shall be prima facie evidence of the title of the person to such shares.

11  
1

(a) Every Member or allottee of shares who is holding such shares in the physical form shall be entitled, without payment, to receive certificate specifying the name of the person in whose favour it is issued, the shares to which it relates and the amount paid-up thereof. Such certificates shall be issued only in pursuance of a resolution passed by the Board and on surrender to the Company of the letter of allotment or the fractional coupons of requisite value, save in case of issues against letters of acceptance or of renunciation or in cases of issue of bonus shares. Every such certificate shall be issued under the seal of the Company, which shall be affixed in the presence of two Directors and the Secretary or some other person appointed by the Board for the purpose, and the two directors and the Secretary or other persons as authorized by the Board shall sign the share certificate. Provided, if the composition of the Board permits of it, at least one of the aforesaid two directors shall be a person other than a Managing or a Whole Time Director. Particulars of every share certificate issued shall be entered in the Register of Members against the name of the person, to whom it has been issued, indicating the date of issue. For issue of any further duplicate certificate, the Board shall be entitled to charge such amount which shall not exceed fifty Rupees per Certificate.

(b) A Director may sign a share certificate by affixing his signature thereon by means of any machine, equipment or other mechanical means such as engraving in metal or lithography, but not by means of a rubber stamp. PROVIDED that the Director shall be personally responsible for the safe custody of such machine equipment or other material used for the purpose.

20 Renewal of Share Certificates

(a) No certificate of any share or shares shall be issued either in exchange for those which are sub-divided or consolidated or in replacement of those which are defaced, mutilated, torn or old, decrepit, destroyed or where the pages on the reverse for recording transfers have been duly utilized, unless the certificate in lieu of which it is issued is surrendered to the Company and for issuing such share certificate the company may charge such fee as the Board thinks fit, not exceeding twenty rupees per certificate.

(b) When a new share certificate has been issued in pursuance of clause (a) of this Article, it shall state on the face of it and against the stub or counterfoil to the effect that it is ?issued in lieu of share certificate No \_\_\_\_\_ sub-divided/replaced/on consolidation.?

(c) If a share certificate is lost or destroyed a new certificate in lieu thereof shall be issued only with the prior consent of the Board and on such reasonable terms, such as furnishing supporting evidence and indemnity and the payment of out-of-pocket expenses incurred by the Company in investigating evidence produced, as the Board thinks fit.

(d) When a new share certificate has been issued in pursuance of clause (c) of this Article, it shall state on the face of it and against the stub or counterfoil to the effect that it is ?duplicate issued in lieu of share certificate No. \_\_\_\_\_? and the word ?duplicate? shall be stamped or printed prominently on the face of the share certificate.



33



(e) Where a new share certificate has been issued in pursuance of clause (a) and/ or clause (c) of this Article, particulars of every such share certificate shall be entered in a Register of Renewed and Duplicate Share Certificates indicating against the name(s) of the person(s) to whom the certificate is issued, the number and date of issue of the share certificate in lieu of which the new certificate is issued and the necessary changes indicated in the Register of Members by suitable cross reference in the 'Remarks' column.

(f) All blank forms to be used for issue of share certificates shall be printed and the printing shall be done only on the authority of a resolution of the Board and the blank forms shall be consecutively machine-numbered and the forms and the blocks, engravings, facsimiles relating to the printing of such forms shall be kept in the custody of the Secretary or of such other person as the Board may appoint for the purpose; and the Secretary or the other person aforesaid shall be responsible for rendering an account of these forms to the Board.

(g) The Committee of the Board, Company Secretary of the Company or a Director specifically authorized by the Board for such purpose shall be responsible for the maintenance, preservation and safe custody of all books and documents relating to the issue of share certificates including the blank forms of share certificates referred to in clause (f).

(h) All books referred to in clause (g) shall be preserved in good order for not less than thirty years and in disputed cases shall be preserved permanently.

21 Joint holders

(a) Where two or more persons are registered as the holders of any share, they shall be treated as a single shareholder and shall be deemed to hold the same as joint holders with benefits of survivorship subject to the following and other provisions contained in these Articles.

(b) The Company shall be entitled to decline to register more than four persons as the holders of any share.

(c) The Joint holders of any share shall be liable, severally as well as jointly, for and in respect of all calls and other payments which ought to be made in respect of such shares.

(d) On the death of any such joint holder, the survivor or survivors shall be the only person or persons recognized by the Company as having any title to the share, but the Directors may require such evidence of death as they may deem fit and nothing herein contained shall be taken to release the estate of the deceased joint holder from any liability on shares held by him jointly with any other person.

(e) Delivery of share certificate to any one of such joint holders shall be deemed to be delivery to all of them and any one of such joint holders may give effectual discharge and receipts for any dividends or other moneys payable in respect of such shares and/or in respect of any other obligation of the Company towards them.

(f) Only the person whose name stands in the Register of Members as the first of the joint holders of any shares shall be entitled to delivery of the certificate relating to such share or to receive notices from the Company, and any notice given to such person shall be deemed proper notice to all joint holders.

(g) Any one of two or more joint holders may vote at any meeting either personally or by proxy in respect of such share as if he were solely entitled thereto, and if more than one of such joint holders be present at any meeting personally or by proxy, the holder whose name stands first or higher (as the case may be) on the Register of Members in respect of such share shall alone be entitled to vote in respect thereof.

PROVIDED always that a member present at any meeting personally shall be entitled to vote in preference to a person present by proxy although the name of such person present by proxy stands first on the Register of Members in respect of such shares.

22 Terms and Conditions of Preference Shares Subject to the provisions of section 55, any preference shares may, with the sanction of an ordinary resolution, be issued on the terms that they are to be redeemed on such terms and in such manner as the company before the issue of the shares may, by special resolution, determine.

<input type="checkbox"/>	<input checked="" type="checkbox"/>	2	
<input type="checkbox"/>	<input checked="" type="checkbox"/>	3	
<input type="checkbox"/>	<input checked="" type="checkbox"/>	4	
<input type="checkbox"/>	<input checked="" type="checkbox"/>	5	





<input type="checkbox"/>	<input checked="" type="checkbox"/>	6	
<input type="checkbox"/>	<input checked="" type="checkbox"/>	7	
<input type="checkbox"/>	<input checked="" type="checkbox"/>	8	
			<b>Lien</b>
<input type="checkbox"/>	<input checked="" type="checkbox"/>	9	<p>23 Company to have lien on shares The Company shall have a first and paramount lien upon all shares (other than fully paid up shares) registered in the name of each member (whether solely or jointly with others) and upon the sale proceeds thereof, for all moneys (whether presently payable or not) called or payable at a fixed time in respect of all such shares (not being fully paid up) for all moneys presently payable by him or his estate to the Company. Any such lien shall extend to all dividends payable and bonuses declared from time to time declared in respect of such shares.</p> <p>24 Enforcing lien by sale For the purpose of enforcing such lien, the Board may sell the shares subject thereto in such manner as they shall think fit, and for that purpose it may cause to be issued a duplicate certificate in respect of such shares and may authorize one of their Directors to execute a transfer thereof on behalf of and in the name of the Board. No sale shall be made until notice period for making call as aforesaid have expired and until notice in writing of the intention to sell shall have been made known to the shareholder for default in payment and default has been made by him in the payment of money called in respect of such shares for thirty days after the date of such notice. Upon issue of a duplicate certificate or certificates in lieu of the original share, the certificate or certificates originally issued shall stand cancelled and become null and void and the same shall have no effect.</p> <p>25 Application of proceeds of sale  The net proceeds of any such sale shall be received by the Company and applied in or towards payment of such part of the amount as is presently payable and the residue, if any, shall (subject to a like lien for sums not presently payable as existed upon the shares before sale) be paid to the person entitled to the shares, at the date of the sale.</p>
<input type="checkbox"/>	<input checked="" type="checkbox"/>	10	
<input type="checkbox"/>	<input checked="" type="checkbox"/>	11	
<input type="checkbox"/>	<input checked="" type="checkbox"/>	12	
			<b>Calls on shares</b>
<input type="checkbox"/>	<input checked="" type="checkbox"/>		<p>26 Directors may make calls The Board may, from time to time, subject to the terms on which any shares may have been issued and subject to the conditions of allotment, by a resolution passed at a meeting of the Board (and not by resolution by circulation) make such call as it thinks fit upon the Members in respect of all moneys unpaid on the shares held by them respectively and each member shall pay the amount of every call so made on him to the person or persons and at the times and places appointed by the board. A call may be made payable by installments.</p> <p>27 Notice of calls Not less than thirty days? notice in writing of any call shall be given by the Company specifying the time and place of payment, and the person or persons to whom such call shall be paid.</p> <p>28 When call made A call shall be deemed to have been made at the time when the resolution of the Board authorizing such call was passed at a meeting of the Board and demand notice is issued.</p> <p>29 Calls may be revoked or postponed A call may be revoked or postponed at the discretion of the Board.</p> <p>30 Directors may extend time The Board may, from time to time at its discretion, extend the time fixed for the payment of any call, and may extend such time as to all or any of the Members for reasons which the Board may consider satisfactory, but no Member shall be entitled to such extension save as a matter of grace.</p> <p>31 Calls to carry interest If any Member fails to pay any call due from him on the day appointed for payment thereof, or any such extension thereof as aforesaid, he shall be liable to pay interest on the same from the day appointed for</p>



35

		13	<p>the payment thereof to the time of actual payment at rate not exceeding 10 per cent per annum as maybe decided by the Board, but the Board may in its absolute discretion and in special circumstances waive or reduce the levy of interest as deemed appropriate.</p> <p>32 Sums deemed to be call</p> <p>Any sum, which by the terms of issue of a share becomes payable on allotment or at any fixed date, whether on account of the nominal value of the share or by way of premium, shall, for the purposes of these Articles be deemed to be a call duly made and payable on the date on which by the terms of issue the same becomes payable, and in case of non-payment all the relevant provisions of these Articles as to payment of interest and expenses, forfeiture or otherwise shall apply as if such sum had become payable by virtue of a call duly made and notified.</p> <p>33 Partial payment not to preclude Forfeiture Neither the receipt by the Company of a portion of any money which shall from time to time be due from any Member to the Company in respect of his shares, either by way of principal or interest nor any indulgence granted by the Company in respect of the payment of any such money, shall preclude the Company from thereafter proceeding to enforce a forfeiture of such shares as hereinafter provided.</p> <p>34 Payment in anticipation of calls may carry interest The Board may, if it thinks fit, agree to and in anticipation receive from any Member willing to advance the same, all of calls money or any part of the amounts of his respective shares beyond the sums actually called up, and upon the moneys so paid in advance, or upon so much thereof, from time to time, and at any time thereafter as exceeds the amount of the calls then made upon and due in respect of the shares on account of which such advances are made, the Board may pay or allow interest, at such rate as the Member paying the sum in advance and the Board agree upon. The Board may agree to repay at any time any amount so advanced or may at any time repay the same upon giving to the Member three months? notice in writing.</p> <p>PROVIDED that moneys paid in advance of calls on any shares may carry interest but shall not confer a right to dividend or to participate in profits.</p> <p>(b) No Member paying any such sum in advance shall be entitled to voting rights in respect of the moneys so paid by him until the same would but for such payment become presently payable.</p>
<input type="checkbox"/>	<input checked="" type="checkbox"/>	14	
<input type="checkbox"/>	<input checked="" type="checkbox"/>	15	
<input type="checkbox"/>	<input checked="" type="checkbox"/>	16	
<input type="checkbox"/>	<input checked="" type="checkbox"/>	17	
<input type="checkbox"/>	<input checked="" type="checkbox"/>	18	
			<b>Transfer of shares</b>
<input type="checkbox"/>	<input checked="" type="checkbox"/>	35	<p><b>Register of Transfers</b> The Company shall maintain a Register of Transfers and therein shall be fairly and distinctively enter the particulars of every transfer or transmission of any share in the physical form.</p> <p>36 <b>Form of transfer</b>The instrument of transfer shall be in writing and in such form as prescribed under the Act. All the provisions of Section 56 of the Act shall be duly complied with in respect of all transfers and of the registration thereof. The Company shall not charge any fee for registration of a transfer of shares or debentures.</p> <p>37 <b>Instrument of Transfer to be completed and presented to the Company</b> The Instrument of Transfer duly stamped and executed by the transferor and the transferee shall be delivered to the Company in accordance with the provisions of the Act. The instrument of transfer shall be accompanied by the Share Certificate or such evidences the Board may require to prove the title of transferor and his right to transfer the shares and every registered Instrument of Transfer shall remain in the custody of the Company until destroyed by order of the Board. Any instrument of transfer which the Directors may decline to register shall be returned to the person depositing the same.</p> <p>38 <b>Transferor deemed to be holder</b> The transferor shall be deemed to be the holder of such shares until the name of the transferee shall have entered in the Register of Members in respect thereof. Before the registration of a transfer, the certificate</p>



36

			<p>or certificates of the shares must be delivered to the Company along with Transfer Deed.</p> <p>39 No transfer to insolvent etc. No transfer shall be made to a person of unsound mind or to an insolvent.</p> <p>40 Closure of Register of Members/Debenture holders The Directors shall have power, on giving not less than seven days' previous notice as required by Section 91 of the Act, to close the Register of Transfer, Register of Members or Register of Debenture holders or the register of other security holders of the Company for any period or periods not exceeding in the aggregate forty-five days in each year (but not exceeding thirty days at any one time) as they may determine.</p> <p>41 Nomination by shareholder Every share-holder or debenture holder may at any time, nominate in the prescribed manner, a person to whom his shares or debenture shall vest in the event of his death, as provided in Section 72 of the Act.</p> <p>42 Title to shares of deceased holder</p> <p>19</p> <p>In the event there is no nomination, the executors or administrators of a deceased Member or the holder of a Succession Certificate in respect of the shares of a deceased Member (not being one of two or more joint holders) shall be the only persons whom the Company will be bound to recognize as having any title to the shares registered in the name of such Member, and the Company shall not be bound to recognize such executors or administrators or holders unless such executors, administrators or holders shall have first obtained probate or Letters of Administration or Succession Certificate as the case may be, from a duly constituted Court in India.</p> <p>PROVIDED that the Directors may, at their absolute discretion dispense with production of Probate, Letters of Administration or Succession Certificate upon such terms as to indemnity or otherwise as they think fit and may enter the name of the person who claims to be absolutely entitled to the shares standing in the name of a deceased Member, as a Member</p>
<input type="checkbox"/>	<input checked="" type="checkbox"/>	20	
<input type="checkbox"/>	<input checked="" type="checkbox"/>	21	
<input type="checkbox"/>	<input checked="" type="checkbox"/>	22	
			<b>Transmission of shares</b>
<input type="checkbox"/>	<input checked="" type="checkbox"/>	43	<p>Transmission of Shares</p> <p>Subject to the provisions of the Act, any person becoming entitled to any share in consequence of the death, lunacy or insolvency of any Member or by any lawful means other than by a transfer in accordance with these Articles, may, with the consent of the Directors (which they shall be under no obligation to give) and upon producing such evidence that he sustains the character in respect of which he proposes to act under this Article or of his title as the Directors may require, and upon such indemnity as the Directors may require, either be registered as a Member in respect of such shares or elect to have some person nominated by him and approved by the Directors registered as a Member in respect of such shares. PROVIDED that if such persons shall elect to have his nominee registered, he shall testify his election by executing in favor of his nominee an</p>



		23	<p>instrument of transfer in accordance with these Articles, and until he does so he shall not be freed from any liability in respect of such shares.</p> <p>44 Right of Board to decline or suspend registration (i) Any person becoming entitled to a share in consequence of the death or insolvency of a member may, upon such evidence being produced as may from time to time properly be required by the Board and subject as hereinafter provided, elect, either --  (a) to be registered himself as holder of the share; or  (b) to make such transfer of the share as the deceased or insolvent member could have made.</p> <p>(ii) The Board shall, in either case, have the same right to decline or suspend registration as it would have had, if the deceased or insolvent member had transferred the share before his death or insolvency.</p> <p>45 The Company not liable for disregard of notice prohibiting registration of transfer  The Company shall incur no liability or responsibility whatever in consequence of its registering or giving effect to any transfer of shares made or purported to be made by any apparent legal owner thereof (as shown or appearing in register of Members) to the prejudice of persons having or claiming any equitable right, title or interest to or in the same shares, notwithstanding that the Company may have had notice of such equitable right, title or interest or notice prohibiting registration of such transfer, and may have entered such notice or referred to it in any book, or attended or given effect to any notice which may have been given to it of any equitable right, title or interest or be under any liability whatsoever for refusing or neglecting so to do though it may have been entered or referred to in some book of the Company, but the Company shall nevertheless be at liberty to regard and attend to any such notice and give effect thereto, if the Directors shall so think fit.</p> <p>46 Rights of successors  A person becoming entitled to a share by reason of the death or insolvency of the holder shall be entitled to the same dividends and other advantages to which he would have been entitled if he were the registered holder of the shares, except that he shall not, before being registered as a Member in respect of the shares, be entitled to exercise any right conferred by membership in relation to meetings of the Company. PROVIDED that the Directors shall, at any time, give notice requiring any such person to elect to be registered himself or to transfer the shares, and if the notice is not complied within ninety days from the date of issue of the notice, the Directors may thereafter withhold payment of all dividends, bonuses or other moneys payable in respect of the shares until the requirements of the notice have been complied with.</p>
<input type="checkbox"/>	<input checked="" type="checkbox"/>	24	
<input type="checkbox"/>	<input checked="" type="checkbox"/>	25	
<input type="checkbox"/>	<input checked="" type="checkbox"/>	26	
			<b>Forfeiture of shares</b>
<input type="checkbox"/>	<input checked="" type="checkbox"/>		<p>47 If money payable on shares not paid notice to be given to members If any Member fails to pay any call, or installment of a call, on or before the day appointed for the payment of the same or any such extension thereof as aforesaid, the Board may, at any time thereafter, during such time as any part of the call or installment remains unpaid, serve a notice on him requiring him to pay the same together with any interest which may have accrued and all expenses that may have been incurred by the Company by reason of such non-payment.</p> <p>48 Contents of Notice The notice shall name a further day (not being less than fourteen days from the date of the service of notice) and a place or places on and at which such call or installment and such interest thereon at such rate as the Directors shall determine from the day on which such call or installment ought to have been paid and expenses as aforesaid are to be paid. The notice shall also state that in the event of the non-payment on or before the day, at or before the time and at the place appointed, the shares in respect of which the call was made or installment is payable, shall be liable to be forfeited.</p> <p>49 In default of payment, shares to be Forfeited If the requirement of any such notice as aforesaid are not complied with, every or any share in respect of which such notice has been given may, at any time thereafter, but before payment of all calls or installments, interest and expenses due in respect thereof, be forfeited by a resolution of the Board to that effect. Such forfeiture shall include all dividends declared or any other moneys payable in respect of the aforesaid share and not actually paid before the forfeiture. In default of payment, shares to be Forfeited</p> <p>50 Notice of forfeiture to a Member When any share shall have been so forfeited, notice of the forfeiture shall be given to the Member in whose name it stood immediately prior to the forfeiture, and an entry of the forfeiture, with the date thereof, shall forthwith be made in the Register of Members, but no forfeiture shall be in any manner invalid by any omission or neglect to make any such entry as aforesaid in the Register.</p> <p>51 Forfeited share to be property of the Company and may be sold etc. Any share so forfeited shall be deemed to be the property of the Company, and may be sold, re-allotted, or otherwise disposed of, either to</p>

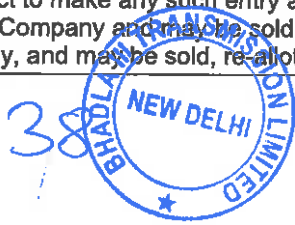



		27	<p>the original holder thereof or to any person, upon such terms and in such manner as the Board shall think fit.</p> <p>52 Member still liable to pay calls owing at the time of forfeiture and interest Any members whose shares have been forfeited shall notwithstanding the forfeiture be liable to pay and shall forthwith pay to the Company, on demand, all calls, installment, interest and expenses owing upon or in respect of such shares at the time of the forfeiture together with interest accrued thereon at the time of the forfeiture at such rate as the Board may determine, and the Board may enforce the payment thereof, if it thinks fit.</p> <p>53 Effect of forfeiture The forfeiture of a share shall involve extinction, at the time of the forfeiture, of all interest in and all claims and demands against the Company, in respect of the share and all other rights incidental to the share, except only such of those rights as by these Articles are expressly saved.</p> <p>54 Evidence of forfeiture A declaration in writing by Chairman or Managing Director of the Company or by any person duly authorised in this regard that certain shares in the Company have been duly forfeited on a date stated in the declaration, shall be conclusive evidence of the facts therein stated as against all persons claiming to be entitled to the shares and such declaration, and the receipt of the Company for the consideration, if any, given for the shares on the sale or disposition thereof shall constitute a good title to such shares and the person to whom the shares are sold shall be registered as the holder of such shares and shall not be bound to see as to the application of the purchase money nor shall his title to such shares be affected by any irregularity or invalidity in the proceedings in reference to such forfeiture, sale or disposition.</p> <p>55 Validity of sale under Articles of forfeited shares Upon any sale after forfeiture or for enforcing a lien in purported exercise of the powers herein before given, the board may appoint some person to execute an instrument of transfer of the shares sold and cause the purchaser's name to be entered in the Register of Members in respect of the shares sold, and the purchaser shall not be bound to see the regularity of the proceedings, or to the application of the purchase money, and after his name has been entered in the Register in respect of such shares the validity of the sale shall not be impeached by any person and the remedy of any person aggrieved by the sale shall be in damages only and against the Company exclusively.</p> <p>56 Cancellation of Share Certificates in respect of forfeited shares Upon any sale, re-allotment or other disposal under the provisions of the preceding Articles, the certificate or certificates originally issued in respect of the relative shares shall (unless the same shall on demand by the Company have been (previously) surrendered to it by the defaulting member) stand cancelled and become null and void and of no effect, and the Directors shall be entitled to issue a duplicate certificate or certificates in respect of the said shares to the person or persons entitled thereto.</p> <p>57 Power to annul forfeiture The Board may at any time before any share so forfeited, shall have been sold, re-allotted or otherwise disposed of, annul the forfeiture thereof upon such terms and conditions as it thinks fit.</p>
<input type="checkbox"/>	<input checked="" type="checkbox"/>	28	
<input type="checkbox"/>	<input checked="" type="checkbox"/>	29	
<input type="checkbox"/>	<input checked="" type="checkbox"/>	30	
<input type="checkbox"/>	<input checked="" type="checkbox"/>	31	
<input type="checkbox"/>	<input checked="" type="checkbox"/>	32	
<input type="checkbox"/>	<input checked="" type="checkbox"/>	33	
			<b>Alteration of capital</b>
<input type="checkbox"/>	<input checked="" type="checkbox"/>		<p>58 Alteration of Share Capital The company may, from time to time, by ordinary resolution increase the share capital by such sum, to be divided into shares of such amount, as may be specified in the resolution.</p> <p>Subject to the provisions of section 61, the company may, by ordinary resolution, the Company may from time to time:--</p> <p>(a) consolidate and divide all or any of its share capital into shares of larger amount than its existing shares;</p> <p>(b) convert all or any of its fully paid-up shares into stock, and reconvert that stock into fully paid-up shares of any denomination;</p> <p>(c) Sub-divide its shares, or any of them into shares of smaller amount than is fixed by the memorandum, so, however, that in the sub-division the proportion between the amount paid and the amount, if any, unpaid on each reduced share shall be the same as it was in the case of the share from which the reduced share is</p>

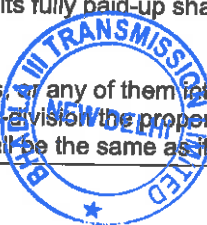

39



		34	<p>derived.;</p> <p>(d) Cancel any shares which as the date of the passing of the resolution, have not been taken or agreed to be taken by any person and diminish the amount of its share capital by the amount of the shares so cancelled.</p> <p>The resolution whereby any share is sub-divided may determine that, as between the holders of the shares resulting from such sub-division, one or more of such shares shall have some preference or special advantage as regards dividend, capital, voting or otherwise over or as compared with the others or other, subject, to the provisions of the Act.</p> <p>Subject to the provisions of Sections 66 of the Act, the Board may accept from any member the surrender on such terms and conditions as shall be agreed of all or any of his shares.</p> <p>The company may, by special resolution, reduce in any manner and with, and subject to, any incident authorised and consent required by law, --</p> <p>(a) its share capital;  (b) any capital redemption reserve account; or  (c) any share premium account.</p>
<input type="checkbox"/>	<input checked="" type="checkbox"/>	35	
<input type="checkbox"/>	<input checked="" type="checkbox"/>	36	
<input type="checkbox"/>	<input checked="" type="checkbox"/>	37	
			<b>Capitalisation of profits</b>
<input type="checkbox"/>	<input checked="" type="checkbox"/>	38	<p>59 Capitalization of Profits (1) Any General Meeting of the Company may resolve that any amounts standing to the credit of the Free Reserve or Share Premium Account or the Capital Redemption Reserve Account or any moneys, investment or other assets forming part of the undivided profits including profits or surplus moneys arising from the realization and (when permitted by the law) from the appreciation in value of any capital assets of the Company standing to the credit of the General Reserve or any other Reserve or Reserve Fund or any other Fund of the Company or in the hands of the Company and available for dividend be capitalized:-</p> <p>(a) by the issue and distribution of shares, as fully paid-up, and to the extent permitted by the Act, debentures, debenture stock, bonds or other obligations of the Company ; or</p> <p>(b) by crediting share of the Company, which may have been issued and are not fully paid-up, with the whole or any part of the sum remaining unpaid thereon;</p> <p>PROVIDED that any amounts standing to the credit of the Share Premium Account or the Capital Redemption Reserve Account shall be applied only in crediting the payment of capital on shares to be issued to Members as fully paid bonus shares (Further capitalization of reserve created by the revaluation of assets are not to be used for issuance of Bonus Shares as per section 63 of the Act).</p> <p>(2) Such issue and distribution under sub-clause (1) (a) of this Article and payment to the credit of unpaid share capital under sub-clause (1) (b) of this Article shall be made among and in favour of the Members or any class of them or any of them entitled thereto and in accordance with their respective rights and interests and in proportion to the amount of capital paid-up on the shares held by them respectively in respect of which such distribution or payment shall be made, on the footing that such Members become entitled thereto as capital.</p> <p>(3) The Directors shall give effect to any such resolution and for the said purpose the Board may settle any difficulty which may arise in regard to distribution as it thinks expedient including in regard to fractional entitlements, and shall apply such profits, General Reserve, other Reserve or any other Fund or account as aforesaid as may be required for the purpose of making payment in full on the shares, or other obligations of the Company so distributed under sub clause (1) (a) of this Article or (as the case may be) for the purpose of paying, in whole or in part, the amount remaining unpaid on the shares which may have been issued and are not fully paid-up under sub-clause (1)(b) above.</p> <p>PROVIDED that no such distribution or payment shall be made unless recommended by the Directors, and, if so recommended, such distribution and payment shall be accepted by such Members as aforesaid in full satisfaction of their interest in the said capitalized fund.</p> <p>(4) For the purpose of giving effect to any such resolution, the Directors may settle any difficulty which may</p>



40

			<p>arise in regard to the distribution or payment as aforesaid as they think expedient, and, in particular, they may issue fractional certificates and may fix the value for distribution of any specific asset and may determine that any cash payment be made to any Members on the footing of the value so fixed and may vest any such cash, shares, debentures stock, bonds or other obligations in trustees upon such trusts for the persons entitled thereto as may seem expedient to the directors, and generally may make arrangement for the acceptance, allotment and sale of such shares, debentures, debentures stock, bonds or other obligations and fractional certificates or otherwise as they may think fit.</p> <p>(5) When deemed requisite, a proper contract shall be filed in accordance with the Act and the Board may appoint any person to sign such contract on behalf of the Members entitled as aforesaid.</p> <p>Subject to the provisions of the Act and these Articles, in cases where some of the shares of the Company are fully paid and others are partly paid, such capitalization may be effected by the distribution of further shares in respect of the fully paid shares and by crediting the partly paid shares with the whole or part of the unpaid liability thereon, but so that as between the holders of the fully paid shares and the partly paid shares, the sums so applied in the payment of such further shares and in the extinguishment or diminution of the liability on the partly paid shares shall be applied pro rata in proportion to the amount then already paid or credited as paid on the existing fully paid and partly paid shares respectively.</p>
<input type="checkbox"/>	<input checked="" type="checkbox"/>	39	
			<b>Buy-back of shares</b>
<input type="checkbox"/>	<input checked="" type="checkbox"/>	40	<p>60 Buy Back of Shares Notwithstanding anything contained in these articles but subject to the provisions of sections 68 to 70 and any other applicable provision of the Act or any other law for the time being in force, the company may purchase its own shares or other specified securities.</p>
			<b>General meetings</b>
<input type="checkbox"/>	<input checked="" type="checkbox"/>	41	<p>61 Annual General Meeting The Company shall in each year hold a General Meeting as its Annual General Meeting in addition to any other meeting in that year. All General Meetings other than Annual General Meetings shall be called Extraordinary General Meetings. If for any reason beyond the control of the Board, the general meeting (including an Annual General meeting) cannot be held on the appointed day, the Board shall have power to postpone the General meeting of which a notice should be given to the members. Every member of the Company shall be entitled to attend either in person or by proxy and the Auditor of the Company shall have the right to attend and to be heard at any General Meeting which he attends on any part of the business which concerns him as Auditor.</p> <p>62 Extraordinary General Meeting The Board may, whenever it thinks fit, call an Extraordinary General Meeting of the Company. The Board shall at the requisition in writing by a Member or Members holding in the aggregate not less than one-tenth of such of the paid-up capital of the company on that date and carries the right of voting in regard to the matter in respect of which the requisition has been made.</p> <p>63 Requisition of Members to state object of Meeting Any valid requisition so made by Members must state the object or objects of the meeting proposed to be called, and must be signed by the requisitionists and deposited at the registered office of the company. PROVIDED that such requisition may consist of several documents in like form, each signed by one or more requisitionists.</p> <p>65 On receipt of requisition Directors to call meeting and in default requisitionists may do so Upon the receipt of any such requisition, the Board shall forthwith call an Extraordinary General Meeting, and if they do not proceed within twenty-one days from the date of the requisition being deposited at the Registered Office to cause a meeting to be called on a day not later than forty-five days from the date of deposit of the requisition, the requisitionists, or such of their number as represent either a majority in value of the paid-up share capital held by all of them or one-tenth of such of the paid-up share capital of the Company as is referred to in Section 100(2) of the Act, whichever is less, may themselves call the meeting, but in either case, any meeting so called shall be held within three months from the date of the deposit of the requisition, as aforesaid.</p> <p>66 Meeting called by requisitionists Any meeting called under the foregoing Articles by the requisitionists shall be called in the same manner, as nearly as possible, as that in which meetings are to be called by the Board.</p> <p>67 Twenty-one days? notice of meeting to be given A general meeting of a Company may be called by giving not less than clear twenty-one days? notice either in writing or through electronic mode in such a manner as may be prescribed, Every notice of a meeting shall specify the place, date, day and the hour of meeting, and shall contain statement of the business to be transacted at such meeting. And, The notice of every meeting shall be given to every member of the Company, Legal Representative of any deceased member or the assignee of an insolvent member, auditor or auditors of the Company and every director of the Company and all such persons as are under these Articles entitled to receive notice from the Company</p> <p>"Provided that a general meeting may be called after giving shorter notice than that specified in this sub-section if consent, in writing or by electronic mode, is accorded thereto ?</p>



(i) in the case of an annual general meeting, by not less than ninety-five per cent. of the members entitled to vote thereat; and  
(ii) in the case of any other general meeting, by members of the company?  
(a) holding, if the company has a share capital, majority in number of members entitled to vote and who represent not less than ninety-five per cent. of such part of the paid-up share capital of the company as gives a right to vote at the meeting; or  
(b) having, if the company has no share capital, not less than ninety-five per cent. of the total voting power exercisable at that meeting;

Provided further that where any member of a company is entitled to vote only on some resolution or resolutions to be moved at a meeting and not on the others, those members shall be taken into account for the purposes of this sub-section in respect of the former resolution or resolutions and not in respect of the latter."

42

**Proceedings at general meetings**

68 Business to be transacted at the General Meeting and nature thereof In the case of an Annual General Meeting, all business to be transacted thereat shall be deemed special, other than (i) the consideration of the financial statements and the reports of the Board of Directors and Auditors; (ii) the declaration of any dividend; (iii) the appointment of Directors in place of those retiring; (iv) the appointment of, and the fixing of the remuneration of, the Auditors, and in the case of any other meeting, all business shall be deemed to be Special Business, and there shall be annexed to the notice of the Meeting an Explanatory statement setting out all material facts concerning each such item of special business, including in particular the nature of the concern or interest, financial or otherwise, if any, therein of (i) every Director, and the Manager (if any); (ii) every other key managerial personnel; and relatives of the persons mentioned in sub clauses (i) and (ii). Where any such item of Special Business relates to, or affects any other company, the extent of shareholding interest in such other company of every promoter, director and the manager, if any, and of every other key managerial personnel of the Company shall also be set out in the statement if the extent of such shareholding interest is not less than two per cent of the paid-up share capital of that other company and where any item of business consists of the according of approval to any documents by the meeting, the time and place where the document can be inspected shall be specified in the statement aforesaid. The annual general meeting shall be called during business hours on any day that is not a National Holiday and it is to be held either at the registered office of the company or at some other place within the city in which the registered office of the company is situate.

69 Omission to give notice not to invalidate a resolution passed The accidental omission to give any such notice as aforesaid to any of the Members, or the non-receipt thereof, shall not invalidate any resolution passed at any such meeting.

70 Meeting not to transact business not mentioned in notice No General Meeting, Annual or Extraordinary, shall be competent to enter upon, discuss or transact any business which has not been mentioned in the notice or notices, upon which it was convened.

71 Body Corporate deemed to be personally present A body corporate being a Member shall be deemed to be personally present if it is represented in accordance with Section 113 of the Act.

72 Quorum at General Meeting No business shall be transacted at any general meeting unless a quorum of members is present at the time when the meeting proceeds to business. Save as otherwise provided herein, the quorum for the general meetings shall be as provided in section 103 of the Companies Act, 2013

73 If quorum not present meeting to be dissolved or adjourned If, at the expiration of half an hour from the time appointed for holding a general meeting of the Company, a quorum is not present, the meeting, if convened by or upon the requisition of Members, shall stand dissolved, but in any other case, the meeting shall stand adjourned to the same day in the next week or, if that day is a public holiday, until the next succeeding day which is not a public holiday, at the same time and place, or to such other day and at such other time & place as the Board may determine, and if at such adjourned meeting a quorum is not present at the expiration of half an hour from the time appointed for holding the meeting, the Members present shall form the quorum, and may transact the business for which the meeting was called.

74 Chairman of General Meeting The Chairman of the Board shall be entitled to take the Chair at every General Meeting whether Annual or Extraordinary. If at any meeting the Chairman is not present within fifteen minutes of the time appointed for holding such meeting or he has informed that he shall be unable or unwilling to take the Chair then any one of directors with mutual consent shall so preside at the meeting. If no Director be present or if all the Directors present decline to take the Chair, then the Members present shall elect one of the members to be the Chairman of the Meeting

75 No Business whilst chair vacant No business shall be discussed at any General Meeting except the election of a Chairman, whilst the Chair is vacant.





- 76 Chairman with consent may adjourn meeting The Chairman, with the consent of the Members, may adjourn any meeting from time to time and from place to place within the city, town or village in which the Registered Office of the Company is situated, but no business shall be transacted at any adjourned meeting other than the business left unfinished at the meeting from which the adjournment took place. Notwithstanding, the provision as above in the event of disorder at a validly convened meeting the Chairman may adjourn the meeting provided that such an adjournment shall not be a longer period than the Chairman considers necessary to bring order at the meeting and Chairman communicates his decision to those present in so far as it is possible.
- 77 Questions at General Meeting how Decided Every question submitted to a meeting shall be decided in the first instance unless a poll is demanded, on a show of hands. Before or on the declaration of the result of the voting on any resolution on a show of hands, a poll may be ordered to be taken by the Chairman of the meeting on his own motion and shall be ordered to be taken by him on a demand made in that behalf by any member or members present in person or by proxy, and holding shares in the Company, which confer a power to vote on the resolution not being less than one-tenth of the total voting power in respect of the Resolution or on which an aggregate sum of not less than five lakh rupees has been paid up. The demand for a poll may be withdrawn at any time by the person or persons making the demand. Unless a poll is so demanded, a declaration by the Chairman that a resolution has, on show of hands, been carried through unanimously or by a particular majority or lost and an entry to that effect in the Minutes Book of the Company shall be conclusive evidence of the fact without proof of the number or proportion of the votes recorded in favour of or against the resolution.
- 78 Chairman's Casting Vote In the case of an equality of votes, the Chairman shall have a casting vote in addition to the vote or votes to which he may be entitled otherwise.
- 79 Poll to be taken, if demanded If a poll is demanded as aforesaid, the same shall be taken at such time (not later than forty-eight hours from the time when the demand was made) and place in the city or town in which the Registered office of the Company is for the time being situated, as the Chairman shall direct, either at once or after an interval or adjournment and the result of the poll shall be deemed to be the resolution of the meeting.
- 80 In which case poll taken without Adjournment Any poll duly demanded on the election of the Chairman of a meeting or on any question of adjournment shall be taken at the meeting forthwith.
- 81 Demand for poll not to prevent transaction of other business  
The demand for a poll except on the questions of the election of the Chairman and of an adjournment shall not prevent the continuance of a meeting for the transaction of any business other than the question on which the poll has been demanded.
- 82 Minutes of General Meetings (a) The Company shall cause minutes of the proceedings of every General Meeting or every resolution passed by postal ballot to be kept by making within thirty days of the conclusion of every such meeting concerned, record thereof kept with Minute Book for that purpose with their pages consecutively numbered.
- (b) Each page of every such book shall be initialed or signed and the last page of the record of proceedings of each meeting in such book shall be dated and signed by the Chairman of the same meeting within the aforesaid period of thirty days or in the event of the death or inability of that Chairman within that period, by a Director duly authorised by the Board for the purpose.
- (c) In no case the minutes of proceedings of a meeting shall be attached to any such book as aforesaid by pasting or otherwise.
- (d) The minutes of each meeting shall contain a fair and correct summary of the proceedings thereat.
- (e) All decisions taken and appointments of officers made at any meeting aforesaid shall be included in the minutes of the meeting.
- (f) Nothing herein contained shall require or be deemed to require the inclusion in any such minutes of any matter which in the opinion of the Chairman of the meeting (a) is or could reasonably be regarded as defamatory of any person, or (b) is irrelevant or immaterial to the proceedings, or (c) is detrimental to the interests of the Company. The Chairman of the meeting shall exercise an absolute discretion in regard to the inclusion or non-inclusion of any matter in the minutes on the aforesaid grounds.
- (g) Any such minutes shall be evidence of the proceedings recorded therein. Where the minutes have been kept in accordance with section then, until the contrary is proved, the meeting shall be deemed to have been duly called and held, all appointments of directors, key managerial personnel, auditors or company secretary in practice, shall be deemed to be valid. No document purporting to be a report of the proceedings of any general meeting of a company shall be circulated or advertised at the expense of the company, unless it includes the matters required to be contained in the minutes of the proceedings of such meeting. The company shall observe secretarial standards with respect to general and Board meetings specified by the Institute of Company Secretaries of India constituted under section 3 of the Company Secretaries Act, 1980, and approved as such by the Central Government.



43

			(h) The book containing the minutes of the proceedings of any general meeting of the Company or of a resolution passed by postal ballot, shall be kept at the registered office of the Company and shall be open, during business hours, to the inspection by any member without any charge, for such period not being less than two hours in each business day are allowed for inspection.
<input type="checkbox"/>	<input checked="" type="checkbox"/>	44	
<input type="checkbox"/>	<input checked="" type="checkbox"/>	45	
<input type="checkbox"/>	<input checked="" type="checkbox"/>	46	
			<b>Adjournment of meeting</b>
<input type="checkbox"/>	<input checked="" type="checkbox"/>	47	<p>83 Adjournment of Meeting (i) The Chairperson may, with the consent of any meeting at which a quorum is present, and shall, if so directed by the meeting, adjourn the meeting from time to time and from place to place.</p> <p>(ii) No business shall be transacted at any adjourned meeting other than the business left unfinished at the meeting from which the adjournment took place.</p> <p>(iii) When a meeting is adjourned for thirty days or more, notice of the adjourned meeting shall be given as in the case of an original meeting.</p> <p>(iv) Save as aforesaid, and as provided in section 103 of the Act, it shall not be necessary to give any notice of an adjournment or of the business to be transacted at an adjourned meeting.</p>
			<b>Voting rights</b>
<input type="checkbox"/>	<input checked="" type="checkbox"/>	48	<p>84 Members in arrears not to vote No member shall be entitled to vote either personally or by proxy at any General Meeting or Meeting of a class of shareholders either upon a show of hands or upon a poll in respect of any shares registered in his name on which any calls or other sums presently payable by him have not been paid or in regard to which the Company has exercised any right of lien.</p> <p>85 Number of votes to which Member Entitled Subject to the provisions of these Articles and without prejudice to any special privileges or restrictions as to voting for the time being attached to any class of shares for the time being forming part of the capital of the Company, every Member shall be entitled to be present, and to speak and vote at such meeting by show of hand for which the Member present in person shall have one vote. On a poll taken at a meeting of a company, a member entitled to more than one vote, or his proxy, need not to use all his votes or cast in the same way all the votes he uses.</p> <p>86 Votes by a Member entitled to more than one vote On a poll taken at a meeting of the Company, a Member entitled to more than one vote by virtue of his share-holding or his proxy or other person entitled to vote for him, as the case may be, need not, if he votes, use all his votes or cast in the same way all the votes he uses and he may vote in different manner as he deems fit.</p> <p>87 Vote of Member who is a minor If any shareholder be a minor, the vote in respect of his share or shares shall be by his guardian, or any one of his guardians, if more than one, to be selected in case of dispute by the Chairman of the meeting.</p> <p>88 Votes of Joint Members If there be joint registered holders of any shares, the vote of the senior who tenders a vote, whether in person or by proxy, shall be accepted to the exclusion of the votes of the other joint holders. For this purpose, seniority shall be determined by the order in which the names stand in the register of members.</p> <p>89 Voting in person or by proxy or Representative Subject to the provisions of these Articles, votes may be given either personally or by proxy. A body corporate being a Member may vote either by proxy or by a representative duly authorised in accordance with Section 113 of the Act and such representative shall be entitled to exercise the same rights and powers (including the right to vote by proxy) and by postal ballot, on behalf of the body corporate which he represents as that body could exercise if it were an individual Member of the Company.</p> <p>90 Votes in respect of shares of Deceased Any person entitled under the Transmission Clause to transfer any shares may vote at any General Meeting in respect thereof in the same manner as if he were the registered holder of such shares. PROVIDED that forty-eight hours at least before the time of holding the meeting or adjourned meeting, as the case may be, at which he proposes to vote he shall satisfy the Chairman of his right to transfer such shares and give such indemnity (if any) as the Chairman may require or the Chairman shall have previously admitted his right to vote at such meeting in respect thereof.</p> <p>91 Time for objection to vote No objection shall be made to the validity of any vote, except at the meeting or poll at which such vote was tendered, and every vote whether given personally or by proxy, not</p>

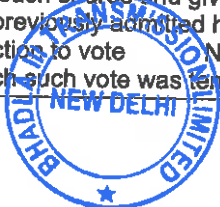



			disallowed at such meeting or poll, shall be deemed valid for purposes of such meeting or poll whatsoever. 92 Chairman of the meeting to be the judge of the validity of any Vote The Chairman of any meeting shall be the sole judge of the validity of every vote tendered at such meeting. The Chairman present at the taking of a poll shall be the sole judge of the validity of every vote tendered at such poll.
<input type="checkbox"/>	<input checked="" type="checkbox"/>	49	
<input type="checkbox"/>	<input checked="" type="checkbox"/>	50	
<input type="checkbox"/>	<input checked="" type="checkbox"/>	51	
<input type="checkbox"/>	<input checked="" type="checkbox"/>	52	
<input type="checkbox"/>	<input checked="" type="checkbox"/>	53	
<input type="checkbox"/>	<input checked="" type="checkbox"/>	54	
			<b>Proxy</b>
<input type="checkbox"/>	<input checked="" type="checkbox"/>	55	93 Appointment of proxy A person can act as proxy on behalf of members not exceeding fifty and holding in the aggregate not more than ten percent of the total share capital of the company carrying voting rights:  Provided that a member holding more than ten percent of the total share capital of the Company carrying voting rights may appoint a single person as proxy and such person shall not act as proxy for any other person or shareholder.  Every proxy shall be appointed in writing under the hand of the Member or if such Member is a body corporate under the common seal of such corporation, or be signed by an appointer or his attorney duly authorised in writing. The proxy so appointed shall not have any right to speak at the meetings. 94 Deposit of instrument of Proxy etc. The instrument appointing a proxy and the power of attorney or other authority (if any), under which it is signed or a notarized copy of that power or authority, shall be deposited at the Registered Office of the Company not later than forty-eight hours before the time for holding the meeting at which the person named in the instrument proposes to vote, and in default, the instrument of proxy shall not be treated as valid. No instrument appointing a proxy shall be valid after the expiration of twelve months from the date of its execution. 95 Form of proxy An instrument appointing a proxy shall be in the form No. MGT-11 as prescribed in the rules made under section 105 of the Companies Act, 2013 96 Proxy either for specified meeting or for a period An instrument of proxy may appoint a proxy either for the purpose of a particular meeting specified in the instrument and any adjournment thereof or it may appoint for the purpose of every meeting of the Company, or of every meeting to be held before a date specified in the instrument and every adjournment of any such meeting. 97 Validity of votes given by proxy notwithstanding death of Member A vote given in accordance with the terms of an instrument of proxy shall be valid, notwithstanding the previous death or insanity of the principal or the revocation of the proxy or of the authority under which the proxy was executed, or the transfer of the shares in respect of which the proxy is given.  Provided that no intimation in writing of such death, insanity, revocation or transfer shall have been received by the company at its office before the commencement of the meeting or adjourned meeting at which the proxy is used.
<input type="checkbox"/>	<input checked="" type="checkbox"/>	56	
<input type="checkbox"/>	<input checked="" type="checkbox"/>	57	
			<b>Board of Directors</b>
<input type="checkbox"/>	<input checked="" type="checkbox"/>	98	Management of Affairs The day to day management of the business and affairs of the Company shall be vested with Project-in-charge under the supervision, direction & control of the Board. The Board, may exercise all such powers of the Company and do all such acts, deeds and things as are not prohibited by the Act or any other statute or by the Memorandum of Association of the Company and without prejudice to the foregoing, shall be responsible for all policy matters and the supervision, direction and control of the conduct of



the business, affairs & operations of the Company.

99 First Directors Shri Milind M. Dafade, Shri Prashant Moundekar and Shri Sanjay Nayak shall be the First Directors of the Company.

100 Number and appointment of Directors The Board of Directors of the Company shall consist of not less than 3 but not more than 15 Directors. A Director shall not be required to hold any qualification shares in the Company.

Notwithstanding anything to the contrary contained in these Articles, so long as any moneys remain owing by the Company to a Financial Institution or any other person by the Company or the Company has entered into any agreement or undertaking or arrangement (hereinafter refer as 'agreement?') with Bodies (like State Electricity Board/Nigam) or the Board of Directors have decided to seek nomination on the Board from the beneficiary state or any Financial Institution or PFC Consulting Limited or person holds Debentures in the Company by direct subscription or private placement, the Company may agree to grant to such Financial Institution, PFC Consulting Limited, person or other Bodies as a condition of such loan or subscription to Debenture or any other agreement or to a Debenture Trustee, the right to appoint from time to time any person or persons as Director or Directors of the Company, (which director or directors is /are hereinafter referred to as 'Nominee Director/s?'), retiring or non-retiring, subject to and on such terms and conditions as the Company may agree with such Financial Institutions, PFC Consulting Limited, Person, other Bodies and/or Debenture Trustee. The Company shall have a right to remove from office Nominee Director(s) at the option of the Company in consultation with Financial Institutions, PFC Consulting Limited, Bodies, persons or Debenture Trustee.

Such Nominee Director(s) shall not be required to hold any Share qualification in the Company. Also at the option of the Company such Nominee Director(s) shall not be liable to retirement by rotation of the Directors. Subject as aforesaid, the Nominee Director(s) shall be entitled to the same rights and privileges and be subject to the same obligations as any other Director of the Company.

The Nominee Director(s) so appointed shall hold the said office only so long as moneys remain owing by the Company to the Financial Institution or so long as the Debenture Trustee hold debenture in the Company or operation of agreement and the Nominee Director/s so appointed in the exercise of the said person shall ipso facto vacate such office immediately the money owing by the Company to the Financial institution, or on the Debenture Trustee ceasing to hold Debentures/ Shares on the satisfaction of liability of the Company arising out of any Guarantee furnished by the Financial Institutions or satisfactory completion of term of agreement with Bodies.

The Nominee Director(s) appointed under this article shall be entitled to receive all notice of and attend all General meeting, Board Meeting and of the meetings of the Committee of which the Nominee Director(s) is/are member(s) as also the minutes of meetings. The financial institutions/Debenture Trustee/persons/bodies shall also be entitled to receive all such notice and minutes.

The Company shall pay to the Nominee Director(s) sitting fees and expenses which other Director of the Company are entitled, but if any other fees, commission, remuneration in any form is payable to the Director of the Company the fees, commission, money and remuneration in relation to such Nominee Director(s) shall accrued to Debenture Trustee and same shall accordingly be paid by the Company directly to the debenture trustee. Any expenses that may incurred by the financial institution or such Nominee Director(s) in connection with their appointment or Directorship shall also be paid or reimbursed by the Company to the financial institution or as the case may be to such Nominee Director(s).

Provided that if any such Nominee Director(s) is/are an officer of the Financial Institution, the sitting fees in relation to such Nominee Director(s) shall also accrue to the Financial Institute and the same shall accordingly be paid by the Company directly to that Financial Institution.

Provided further that if such Nominee Director(s) is/are an official of any of the Reserve Bank of India, the sitting fees in relation to such Nominee Director(s) shall also accrue to Financial Institution to whom he represents as Nominee Director from Reserve Bank of India and the same shall accordingly be paid by the Company directly to that Financial Institution.

Provided also that in the event of the Nominee Director(s) being appointed as Whole Time Director(s) such Nominee Director(s) shall exercise such powers and duties as may be approved by the Lenders or Bodies in consultation with Board and have such rights as are usually exercised or available to a Whole Time Director, in management of the Borrower or Bodies and such Nominee Director(s) shall be entitled to receive such remuneration fees commission and moneys as may be approved by the Lenders or Bodies in consultation with Board.

101 Company may increase the number of Directors Subject to Section 149 of the Act, the Company may subject to special resolution in General Meeting increase the maximum number of Directors.



46

Further the Company may, subject to the provisions of Section 169 of the Act, by passing the ordinary resolution in the General Meeting of the members, may remove any Director before the expiration of his period of office and appoint another person in the place of director so removed.

102 Appointment of Alternate Directors In accordance with Section 161 and other applicable provisions (if any) of the Act, the Board shall have power at any time and from time to time, to, appoint a person, not being a person holding any alternate directorship for any other Director in the Company, to act as an alternate director for a director (hereinafter called 'the original Director?') during his absence for a period of not less than three months from India.

103 Directors? power to fill up casual Vacancies Casual vacancies among Directors may be filled by the Board of Directors at their meeting and any person so appointed shall hold the office as per the provision of section 161.

104 Appointment of Additional Director Subject to the provisions of Section 161 and other applicable provisions (if any) of the Act, the Board shall have power at any time and from time to time, to appoint a person as an Additional Director but so that the total number of Directors shall not at any time exceed the maximum number fixed by these Articles. The Additional Director so appointed shall retire from Office at next following Annual General Meeting but shall be eligible for election by the company at that meeting as a Director.

105 Directors may act notwithstanding any vacancy The continuing Directors may act notwithstanding any vacancy in their body, but if, and so long as their number is reduced below the minimum number fixed by Article 100 thereof, the continuing Directors may act for the purpose of increasing the number of Directors to that number, or of summoning a General Meeting for that purpose.

106 Remuneration of Directors Subject to the provisions of the Act, the Chairman or Managing Director or any other functional Directors who is/are in the whole-time employment of the Company may be paid remuneration either by way of a monthly payment or at a specified percentage of the net profit of the Company or partly by one way and partly by the other, keeping in view the limiting provisions governing the Managerial remuneration under the provisions of the Act.

58

Subject to the provisions of the Act, a Director, who is neither in the whole-time employment nor a Chairman cum Managing Director of the Company may be paid remuneration either:-

- (a) by way of monthly, quarterly or annual payment with the approval of the Central Government, or
- (b) by way of commission if the Company by a special resolution authorizes such payment; and

The sitting fee payable to a Director (excluding Whole-time Director) for attending a meeting of the Board or Committee thereof shall be such sum as may be fixed by the Board provided that the same shall not exceed Rs. 1,00,000/- or such other sum as prescribed in the Act as amended from time to time.

Travelling expenses incurred by Director going out on Company?s Business

The Board may allow and pay to any Director who is not a bona-fide resident of the place where the Registered Office of the Company or where the meetings of the Board are actually held and who has to come to such place for the purpose of attending any meeting, such sum as the Board may consider fair compensation for travelling, boarding, lodging and other actual incidental expenses, in addition to his fee for attending such meeting as specified above. If any Director be called upon to go or reside out of the bonafide place of his residence on the Company?s business, he shall be entitled to be paid and reimbursed any travelling or other actual expenses incurred by him in connection with the business of the Company.

107 When office of Directors to become Vacant Subject to Section 167 of the Act, the office of a Director shall become vacant if:-

- (a) he incurs any of the disqualifications specified in section 164 under the act;
  - (b) he absents himself from all the meetings of the Board of Directors held during a period of twelve months with or without seeking leave of absence of the Board;
  - (c) he acts in contravention of the provisions of entering into contracts or arrangements in which he is directly or indirectly interested;
  - (d) he fails to disclose his interest in any contract or arrangement in which he is directly or indirectly interested;
  - (e) he becomes disqualified by an order of a court or the Tribunal;
  - (f) he is convicted by a court of any offence, whether involving moral turpitude or otherwise and sentenced in respect thereof to imprisonment for not less than six months:  
Provided that the office shall be vacated by the director even if he has filed an appeal against the order of such court;
  - (g) he is removed in pursuance of the provisions of this Act;
  - (h) he, having been appointed a director by virtue of his holding any office or other employment in the holding, subsidiary or associate company, ceases to hold such office or other employment in that company.
- 108 Directors may contract with Company Except with the consent of the Board of Directors given by a resolution at a meeting of the Board and subject to such conditions, the company shall not enter into any contract or arrangement with a related party with respect to?



47



- (a) sale, purchase or supply of any goods or materials;
- (b) selling or otherwise disposing of, or buying, property of any kind;
- (c) leasing of property of any kind;
- (d) availing or rendering of any services;
- (e) appointment of any agent for purchase or sale of goods, materials, services or property;
- (f) such related party's appointment to any office or place of profit in the company, its subsidiary company or associate company;
- (g) underwriting the subscription of any securities or derivatives thereof, of the company.

Every contract or arrangement entered as related party transaction shall be referred in the Board's report to the shareholders along with the justification for entering into such contract or arrangement.

109 Disclosure of interest by Directors 1) Every Director of the Company, who is in any way, whether directly or indirectly, concerned or interested in a contract or arrangement, or proposed by Directors interested in a contract or arrangement, or proposed contract or arrangement entered into or to be entered into, by or on behalf of the Company, shall disclose the nature of his concern or interest at every financial year or whenever there is change in the disclosure of interest.

(2) Nothing in sub-clause (1) of this Article shall apply to any contract or arrangement entered into or to be entered into between the Company and any other company, where any of the Directors of the Company or two or more of the Directors together holds or hold not more than two per cent of the paid-up share capital in the other company

110 Interested Directors not to participate or vote in Board's proceedings An interested director, who is in any way, whether by himself or through any of his relatives or firm, body corporate or other association of individuals in which he or any of his relatives is a partner, director or a member, interested in a contract or arrangement, or proposed contract or arrangement, entered into or to be entered into by or on behalf of a company, shall, take any part in the discussion of, or vote on any contract or arrangement entered into, or to be entered into, by or on behalf of the Company, if he is in any way, whether directly or indirectly, concerned or interested in such contract or arrangement, nor shall his presence count for the purpose of forming a quorum at the time of any such discussion or vote, and if he does vote, his vote shall be void.

A contract or arrangement entered into by the company without disclosure or with participation by a director who is concerned or interested in any way, directly or indirectly, in the contract or arrangement, shall be voidable at the option of the company.

111 Register of Contracts in which Directors are interested The company shall keep registers in accordance with Section 189(1) giving separately the particulars of all contracts or arrangements to which to matter of disclosure of interest by directors and related party transaction applies, in such manner and containing such particulars as may be prescribed and after entering the particulars, such registers shall be placed before the next meeting of the Board and signed by all the directors present at the meeting and shall within thirty days of appointment make such disclosure as are necessary for the purpose of same.

The Register shall be kept at the Registered office of the Company and shall be open to inspection at such office shall be open for inspection at such office during business hours and extracts may be taken there from, and copies thereof as may be required by any member of the company shall be furnished by the company to such extent, in such manner, and on payment of same fee as in the case of the Register of Members of the Company.

112 Director may be Director of companies promoted by the Company A Director may become a Director of any other company promoted by the Company, or in which it may be interested as a vendor, shareholder, or otherwise and no such Director shall be accountable for any benefits received as Director or shareholder of such a company except in so far as Section 188 of the Act may be applicable.

113 Register of Directors and key managerial personnel and their Shareholding The Company shall keep at its registered office a Register containing such particulars of its Directors and key managerial personnel, Manager as may be prescribed under Section 170 of the Act and shall comply with the provisions of the said Section in all respects. The register shall include the details of securities held by each of them in the company or its holding, subsidiary, subsidiary of company's holding company or associate companies.

<input type="checkbox"/>	<input checked="" type="checkbox"/>	59	
<input type="checkbox"/>	<input checked="" type="checkbox"/>	60	
<input type="checkbox"/>	<input checked="" type="checkbox"/>	61	
<input type="checkbox"/>	<input checked="" type="checkbox"/>	62	



48

<input type="checkbox"/>	<input checked="" type="checkbox"/>	63	
<input type="checkbox"/>	<input checked="" type="checkbox"/>	64	

**Proceedings of the Board**

<input type="checkbox"/>	<input checked="" type="checkbox"/>	<p>114 Meetings of Directors The Directors may meet together as a Board for the dispatch of business from time to time, so that at least four such meetings shall be held in every year in such a manner that not more than one hundred and twenty days shall intervene between two consecutive meetings of the Board. The Directors may adjourn and regulate their meetings as they think fit.</p> <p>115 Board may appoint Chairman All meetings of the Directors shall be presided over by the Chairman, if present, but, if at any meeting of the Directors, the Chairman is not present at the time appointed for holding the same then in that case the Directors shall choose one of the Directors present to preside over the meeting.</p> <p>116 Certain persons not to be appointed Chairman &amp; Managing Directors &amp; Functional Director The Company shall not appoint a person as its Chairman, Managing Director or Whole-time Director who:-          (a) is an undischarged insolvent, or had at any time been adjudged an insolvent;          (b) is or has at any time been, convicted by a Court of an offence involving moral turpitude.</p> <p>117 Notice of Director's Meeting A meeting of the Board shall be called by giving not less than seven days' notice in writing to every director at his address registered with the company and such notice shall be sent by hand delivery or by post or by electronic means. Board may be called at shorter notice to transact urgent business where at least one independent director, if any, shall be present.</p> <p>Every notice convening a meeting of the Board of Directors shall set out the agenda of the business to be transacted thereat in sufficient detail provided however that the meeting may consider any other business with the permission of the chair.</p> <p>118 When meeting to be convened The Company Secretary or any director of the Company may, as and when directed by the Chairman to do so, convene a meeting of the Board by giving a notice in writing to every Director.</p> <p>119 Quorum at Board Meeting No business shall be transacted at any Board meeting unless a quorum of Board of Director is present at the time when the meeting proceeds to business. Save as otherwise provided herein, the quorum for the Board meetings shall be as provided in section 174.</p> <p>120</p> <p>Questions at Board meetings how to be decided All questions arising at a Meeting of the Board or any committee thereof shall be decided by majority of votes of directors present and in case of equality of votes, the Chairperson shall have a second and casting vote.</p> <p>121 Committee of Board Subject to the restrictions contained in Section 179, 180 and other applicable provisions of the Act and preceding Articles, the Board may delegate any of its powers to Committees of the Board consisting of such member or members of its body as it may think fit.</p> <p>PROVIDED that the Board may, from time to time, revoke, modify and discharge any such Committee of the Board either wholly or in part. Every Committee of the Board so formed shall in the exercise of the powers so delegated conform to any Policy/regulations that may, from time to time, be laid down by the Board. All acts done by any such Committee of the Board in conformity with such regulations and in fulfillment of the purposes of their appointment shall have the like force and effect as if done by the Board</p> <p>122 Meeting of Committee how to be Governed The meetings and proceedings of any such Committee of the Board consisting of two or more members shall be governed by the provisions of the act and guidelines laid down for regulating the meetings and proceedings of the Directors, so far as the same are applicable thereto and are not superseded by any regulations made by Directors under the last preceding Article.</p> <p>123 Resolution by circulation No resolution on matters shall be deemed to have been duly passed by the Board or by a Committee thereof by circulation, unless the resolution has been circulated in draft, together with the necessary papers, if any, to all the Directors, or members of the Committee, as the case may be, at their addresses registered with the company in India by hand delivery or by post or by courier, or through such electronic means as may be prescribed and has been approved by a majority of the directors or members, who are entitled to vote on the resolution. Resolution passed in such circulation shall be made part of the minutes of such meeting.</p> <p>Provided that, where not less than one-third of the total number of directors of the company for the time being require that any resolution under circulation must be decided at a meeting, the chairperson shall put the resolution to be decided at a meeting of the Board.</p> <p>124 Defects in appointment of Directors not to invalidate actions taken All acts done by any meeting</p>
--------------------------	-------------------------------------	---



49



of the Board, or by a Committee of the Board, or by any person acting as a Director shall notwithstanding that it was subsequently noticed that there was some defect in the appointment of such Director or persons acting as aforesaid, or that they, or any of them, were disqualified or had vacated office or that the appointment of any of them had been terminated by virtue of any provisions contained in the Act or these Articles, be as valid as if every such person had been duly appointed and was qualified to be a Director and had not vacated his office or his appointment had not been terminated.

PROVIDED that nothing in this Article shall be deemed to give validity to acts done by a Director after his appointment had been noticed by the Company to be invalid or to have terminated.

125 Minutes of proceedings of meetings of the Board (a) The Company shall cause minutes of all proceedings of every meeting of the Board and committee thereof to be kept by making within thirty days of the conclusion of every such meeting record thereof in Minute Book kept for that purpose with their pages consecutively numbered.

(b) Each page of every such book shall be initialed or signed and the last page of the record of proceedings of each meeting in such book shall be dated and signed by the Chairman of the said meeting or the Chairman of the next succeeding meeting.

The minute books of the Board and committee meetings shall be preserved permanently and kept in the custody of the company secretary of the company or any director duly authorized by the Board for the purpose and shall be kept in the registered office or such place as Board may decide.

The minutes shall also contain:-

(i) the names of the Directors present at the meeting;

And

(ii) in the case of each resolution passed at the meeting, the names of the Directors, if any, dissenting from, or not concurring with the resolution.

Nothing deemed to require the inclusion in any such minutes of any matter which, in the opinion of the Chairman of the meeting ?

(i) is, or could reasonably be regarded as, defamatory of any person.

(ii) is irrelevant or immaterial to the proceedings, or

(iii) is detrimental to the interests of the Company. The Chairman shall exercise an absolute discretion in regard to the inclusion or non-inclusion of any matter in the minutes on the grounds specified in this sub-clause.

(c) Minutes of meetings kept in accordance with the aforesaid provisions shall be evidence of the proceedings recorded therein.

126 Powers of Board The Board may exercise all such powers of the Company and do all such acts and things as it is entitled to do under section 179 of the Act and rules made thereunder, or by the Memorandum or Articles of the Company but shall not decide matters required to be exercised or done by the Company in General Meeting, Subject to these Articles no regulation made by the Company in General Meeting shall invalidate any prior act of the Board which would have been valid if that regulation had not been so made.

#### Certain powers of the Board

Without prejudice to the general powers conferred by the Act and preceding Article and so as not in any way to limit or restrict those powers, and without prejudice to the other powers conferred by these Articles and by General Body, it is hereby declared that the Directors shall have the following powers, that is to say, power:-

(1) to pay and charge to the capital account of the Company any commission or interest lawfully payable there out under the provisions of Sections 40 of the Act;

(2) Subject to Sections 179 and 180 of the Act, to purchase or otherwise acquire for the Company any property, rights or privileges which the Company is authorised to acquire, at or for such price or consideration and generally on such terms and conditions as they may think fit, and in any such purchase or other acquisition to accept such title as the Directors may believe or may be advised to be reasonably satisfactory;

(3) At their discretion and subject to the provisions of the Act, to pay for any property, rights or privileges acquired by, or services rendered to, the Company either wholly or partially, in cash or in shares, bonds, debentures, mortgages, or other securities of the Company, and any such shares may be issued either as fully paid-up or with such amount credited as paid-up thereon as may be agreed upon, and any such bonds,



65

debentures, mortgages or other securities may be either specially charged upon all or any part of the property of the Company and its uncalled capital or not so charged;

(4) To secure the fulfillment of any contract or engagement entered into by the Company in the normal course of business, by mortgage or charge any of the property of the Company and its uncalled capital for the time being or in such manner as they may think fit;

(5) To accept from any Member, as far as may be permissible by law, a surrender of his shares or any part thereof, on such terms and conditions as shall be agreed upon;

(6) To appoint any person to accept and hold in trust for the Company any property belonging to the Company, in which it is interested, or for any other purposes and to execute and do all such deeds and things as may be required in relation to any such trust, and to provide for the remuneration of such trust or trustees;

(7) To institute, conduct, defend, compound, or abandon any legal proceedings by or against the Company or its officers, or otherwise concerning the affairs of the Company, and also to compound and allow time for payment or satisfaction of any debts due and of any claim or demand by or against the Company and to refer any differences to arbitration, and observe and execute any awards made thereon;

(8) To act on behalf of the Company in all matters relating to bankruptcy and insolvency;

(9) To make and give receipts, releases, and other discharges for moneys payable to the Company and for the claims and demands of the Company;

(10) Subject to applicable provisions of the Act, to invest and deal with any moneys of the Company not immediately required for the purposes thereof upon such security (not being shares of this Company), or without security and in such manner as they may think fit, and from time to time to vary or realise such investments. Save as provided in Section 187 of the Act, all investments shall be made and held in the Company's own name;

(11) To execute, in the name and on behalf of the Company, in favour of any Director or other person who may incur or going to incur any personal liability whether as principal or surety, for the benefit of the Company, such mortgages of the Company's property (present and future) as they think fit, and any such mortgage may contain a power of sale and such other powers, provisions covenants as shall be agreed upon;

(12) To open account with any bank or banks and to determine from time to time who shall be entitled to sign, on the Company's behalf bills, notes, receipts, acceptances, endorsements, cheques dividend warrants, releases, contracts and documents and to issue the necessary authority for such purpose;

(13) To distribute by way of bonus or commission amongst the staff of the Company on the profits of any particular business or transaction, and to charge such bonus or commission as part of the working expense of the Company;

(14) To provide for the welfare of employees or ex-employees of the Company and their families or connections of such persons, by building or contributing to the building of houses, dwellings or chawls, or by grants of money, pension, gratuities, allowances, bonus or other payments, or by creating, and from time to time subscribing or contributing to provident and other funds, associations, institutions or trusts and by providing or subscribing or contributing towards places of instrument and recreation, hospitals and dispensaries, medical and other attendance and other assistance as the Board shall think fit; and to subscribe or contribute or otherwise to assist or to guarantee money to charitable, benevolent, religious, scientific, national or other institutions or objects which shall have any moral or other claim to support or aid by the Company either by reason of locality of operation, or of public and general utility or otherwise;

(15) Before recommending any dividend, to set aside out of the profits of the Company such sums as they may think proper for depreciation or to a Depreciation Fund, or to an Insurance Fund, or as a Reserve Fund or Sinking Fund or any Special Fund to meet contingencies or to repay debentures or debenture stock; or for special dividends or for equalizing dividends or for repairing, improving, extending and maintaining any of the property of the Company and for such other purposes (including the purposes referred to in the preceding clause), as the Board may, in their absolute discretion, think conducive to the interest of the Company, and subject to Section 179 of the Act, to invest the several sums so set aside or so much thereof as required to be invested, upon such investments (other than shares of the Company) as they may think fit, and from time to time to deal with and vary such investments and dispose of and apply and expend all or any part thereof for the benefit of the Company, in such manner and for such purposes as the Board, in their absolute discretion, think conducive to the interest of the Company notwithstanding that the matters to which the Board apply or upon which they expend the same or any part thereof, may be matters to or upon which the capital moneys of the Company might rightly be applied or expended, and to divide the Reserve Fund or division or a reserve



51

Fund to another Reserve Fund or division of a Reserve Fund and with full power to employ the assets constituting all or any of the above funds, including the Depreciation Fund, in the business of the Company or in the purchase or repayment of Debentures or debenture stock, and without being bound to keep the same separate from the other assets, and without being bound to pay interest on the same with power however to the Board at their discretion to pay or allow to the credit of such funds interest at such rate as the Board may think proper;

(16) To appoint and at their discretion remove or suspend such officers such as Executive Director, general managers, managers, secretaries, assistants, supervisors, clerks, agents and servants etc. for permanent, temporary or special services as they may from time to time think fit, and to determine their powers and duties and fix their salaries or emoluments or remunerations and to require security in such instances and to such amounts as they may think fit. And also from time to time to provide for the management and transaction of the affairs of the Company in any specified locality in India or abroad in such manner as they think fit, and the provisions contained in the following sub-clauses shall be without prejudice to the general powers conferred by this sub clause;

(17) From time to time and at any time to establish any number of offices and establishment for properly managing the affairs of the Company in any specified locality in India or elsewhere and to appoint staff for such offices and to fix their remuneration;

(18) Subject to the provisions of the Act, from time to time and at any time, to delegate to any such local Board, or any member or members thereof or any managers or agents so appointed or to any other person(s) any of the powers, authorities, and discretions for the time being vested in the Board, and to authorise the members for the time being of any such local Board, or any of them to fill up any vacancies, therein and to act notwithstanding vacancies and any such appointment or delegation under the preceding and this sub-clause may be made on such terms and subject to such conditions as the Board may think fit, and the Board may at any time remove any person so appointed, and may annul or vary any such delegation;

(19) At any time and from time to time by Power of Attorney under the Seal of the Company, to appoint any person or persons to be the Attorney or Attorneys of the Company for such purposes and with such powers, authorities and discretions (not exceeding those vested in or exercisable by the Board under these presents and excluding the power to make calls and excluding also those which are to be exercised by the Board, in its Meetings) and for such period and subject to such conditions as the Board may from time to time think fit, and any such appointment may (if the Board thinks fit) be made in favour of the members or any of the members of any local Board, established as aforesaid or in favour of any company, or the shareholders, directors, nominees, or managers or any company or firm or otherwise in favour of any persons whether appointed by name or designation by the Board and any such Power of Attorney may contain such powers for the protection or convenience of such Attorney as the Board may think fit, and Board may specifically bestow powers enabling any such delegate or attorneys to sub-delegate all or any of the powers, authorities and discretions for the time being vested in them;

(20) Subject to Sections 188 of the Act, for or in relation to any of the matters aforesaid or otherwise for the purposes of the Company, to enter into such negotiations and contracts and rescind and vary such contracts, and execute and do all such acts deeds and things in the name and on behalf of the Company as they may consider expedient;

(21) From time to time to make vary and repeal bye-laws for the regulations of the business of the Company regulate employment of its officers and servants by making service Rules and Regulations;

(22) Maintain proper records at places as per provisions of the Act and where the Company has a branch office, whether in or outside India, the Company shall be deemed to have complied with this Article if proper Books of Account relating to the transactions effected at the branch office are kept at the branch office and proper summarized returns, made up-to-date at intervals of not more than three months, are sent by the branch office to the Company at its Office or other place in India, at which the Company's Books of Accounts are kept as aforesaid;

(23) Ensure proper maintenance of the Books of Account which shall give a true and fair view of the state of the affairs of the Company or branch office, as the case may be, and explain its transactions. The Books of Account and other books and papers shall be open to inspection by any Director during business hours.

66

67



52

<input type="checkbox"/>	<input checked="" type="checkbox"/>	68	
<input type="checkbox"/>	<input checked="" type="checkbox"/>	69	
<input type="checkbox"/>	<input checked="" type="checkbox"/>	70	
<input type="checkbox"/>	<input checked="" type="checkbox"/>	71	
<input type="checkbox"/>	<input checked="" type="checkbox"/>	72	
<input type="checkbox"/>	<input checked="" type="checkbox"/>	73	
			<b>Chief Executive Officer, Manager, Company Secretary or Chief Financial Officer</b>
<input type="checkbox"/>	<input checked="" type="checkbox"/>	74	<p>127 CEO, MANAGER, CS AND CFO Subject to the provisions of the Act, --</p> <p>(i) A chief executive officer, manager, company secretary or chief financial officer may be appointed by the Board for such term, at such remuneration and upon such conditions as it may think fit; and any chief executive officer, manager, company secretary or chief financial officer so appointed may be removed by means of a resolution of the Board;</p> <p>(ii) A director may be appointed as chief executive officer, manager, company secretary or chief financial officer</p> <p>As per provisions of the Act or these regulations requiring or authorising a thing to be done by or to a director and chief executive officer, manager, company secretary or chief financial officer shall not be satisfied by its being done by or to the same person acting both as director and as, or in place of, chief executive officer, manager, company secretary or chief financial officer.</p>
<input type="checkbox"/>	<input checked="" type="checkbox"/>	75	
			<b>The Seal</b>
<input type="checkbox"/>	<input checked="" type="checkbox"/>	76	<p>128 The Seal its custody and use The Board shall provide a Common Seal for the purpose of the Company, and shall have power, from time to time, to destroy the same and substitute a new Seal in lieu thereof, and the Board shall provide for the safe custody of the Seal for the time being, and the seal shall never be used except on the authority of the Board or by Committee of the Board as authorised.'</p> <p>129 Deeds how executed Every deed or other instrument, to which the Seal of the Company is required to be affixed, shall unless the same is executed by a duly constituted attorney issued under the seal; be signed by two Directors or one Director and Secretary or some other person authorised by the Board for the purpose:</p> <p>PROVIDED that in respect of the Share Certificate, the Seal shall be affixed in accordance with Article as mentioned above.</p>
			<b>Dividends and Reserve</b>
<input type="checkbox"/>	<input checked="" type="checkbox"/>	130	<p>Division of profits and dividends in proportion to amount paid-up</p> <p>(a) The profits of the Company, subject to any special rights relating thereto created or authorised to be created by these Articles and subject to the provisions of these Articles, shall be divisible among the Members in proportion to the amount of capital paid-up or credited as paid-up on the shares held by them.</p> <p>(b) All dividends shall be apportioned and paid proportionately to the amounts paid or credited as paid on the shares held during any portion or portions of the period in respect of which the dividend is paid, but if any share is issued on terms providing that it shall rank for dividend from a particular date, such share shall rank for dividend accordingly.</p> <p>131 The Company in General Meeting may declare a dividend Company in General Meeting may declare dividends to be paid to Members according to their respective rights, but no dividends shall exceed the amount recommended by the Board, but the Company in General Meeting may declare a smaller dividend.</p> <p>132 Dividends only to be paid out of Profits a) No dividend shall be declared or paid by the Company for any financial year except out of its profits for that year arrived at in the manner set out in Section 123 of the Act.</p> <p>(b) Where, owing to inadequacy or absence of profits in any financial year, any Company proposes to declare dividend out of the accumulated profits earned by it in previous years and transferred by the company to reserves, such declaration of dividend shall not be made except in accordance with such rules as may be</p>



S3



made in that behalf.  
 (c) No dividend shall be declared or paid by a company from its reserves other than free reserves.  
 133 Interim Dividend Subject to the provisions of Section 123, the Board may, from time to time, pay the Members such interim dividend as appear to it to be justified by the profits of the Company.  
 134 Capital paid - up in advance to carry Interest Where capital is paid in advance of calls such capital may carry interest but shall not in respect thereof confer a right to dividend or participate in profits.  
 135 Retention of dividends until completion of transfer The Board may retain the dividends payable on shares in terms of Section 126 in respect of which any person is entitled to become a Member, or on completion any person under those Articles is entitled to transfer, or until such person shall become a Member in respect of such shares or shall duly transfer the same.  
 136 Transfer of shares must be Registered A transfer of shares shall not pass the right to any dividend declared thereon before the registration of transfer. Provided that where any instrument of transfer of shares has been delivered to the Company for registration and the transfer of such shares has not been registered by the Company, it shall, notwithstanding anything contained in any other provision of this Act

77

a) transfer the dividend in relation to such shares to the Unpaid Dividend Account referred to in Section 124 of the Act unless the Company is authorised by the registered holder of such shares in writing to pay such dividend to the transferee specified in such instrument of transfer ;and

(b) keep in abeyance in relation to such shares, any offer of rights shares under clause (a) of sub-section (1) of section 62 of the Act and any issue of fully paid-up bonus shares in pursuance of first proviso to sub-section (5) of section 123 of the Act.

137 No Member to receive dividend whilst indebted to the Company & Company's right of reimbursement Thereon No Member shall be entitled to receive payment as interest or dividend in respect of his shares, whilst any money may be due or owing from him to the Company in respect of such share or shares or otherwise howsoever, either alone or jointly with any person or persons, and the Board may deduct from the interest or dividend payable to any Member all sums of money so due from him to the Company.

138 Dividends how remitted (1) Unless otherwise directed any dividend payable in cash may be paid by cheque or warrant or in any electronic mode or by a pay slip or receipt or in any other manner having the force of a cheque or warrant sent through the post to the registered address of the Member or person entitled or in case of joint holders to that one of them first named in the Register in respect of the joint holdings. Every such cheque or warrant shall be made payable to the order of the person to whom it is sent the Company shall not be liable or responsible for any cheque or warrant or pay slip or receipt lost in transmission, or for any dividend lost to the Member or person entitled thereto by the forged endorsement of any cheque or warrant or the forged signature of any pay slip or receipt or the fraudulent recovery of the dividend by any other means.

(2) Notwithstanding anything contained in these Articles any dividend declared, may be paid by Electronic Clearing System through any Sponsor Bank, after getting registration with the Reserve Bank of India for using this facility and collecting from the members necessary bank mandate in the prescribed format.

139 Dividends and call together Any General Meeting declaring a dividend, may, on the recommendation of the Board, make a call on the Members of such amount as the meeting may fix, but so that the call on each Member shall not exceed the dividend payable to him and so that the call be made payable at the same time as the dividend, and the dividend may, if so arranged between the Company and the Member, be set off against the calls.

140 Unclaimed dividend No unclaimed dividend shall be forfeited and all unclaimed dividends shall be dealt with in accordance with the provisions of Section 124 and other applicable provisions of the Act.

141 No interest against Dividend No dividend shall bear interest against the company.

<input type="checkbox"/>	<input checked="" type="checkbox"/>	78	
<input type="checkbox"/>	<input checked="" type="checkbox"/>	79	
<input type="checkbox"/>	<input checked="" type="checkbox"/>	80	
<input type="checkbox"/>	<input checked="" type="checkbox"/>	81	
<input type="checkbox"/>	<input checked="" type="checkbox"/>	82	
<input type="checkbox"/>	<input checked="" type="checkbox"/>	83	
<input type="checkbox"/>	<input checked="" type="checkbox"/>	84	

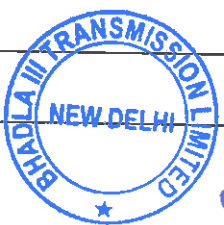

54



<input type="checkbox"/>	<input checked="" type="checkbox"/>	85	
			<b>Accounts</b>
<input type="checkbox"/>	<input checked="" type="checkbox"/>	86	<p>142 Directors to keep true accounts (a) Every company shall prepare and keep at its registered office including its branch office or offices or at such other place in India as the Board thinks fit, Books of Accounts and other relevant books and papers and financial statement for every financial year which give a true and fair view of the state of the affairs of the company in accordance with Section 128 of the Act with respect to-</p> <p>(i) all sums of money received and expended by the Company and the matters in respect of which the receipts and expenditure take place;</p> <p>(ii) all sales and purchases of goods by the Company;</p> <p>(iii) the assets and liabilities of the Company.</p> <p>(iv) state of affairs of the company.</p> <p>(b) Where the Board decides to keep all or any of the Books of Account at any place other than the Office of the Company, the Company shall within seven days of the decision file with the Registrar a Notice in writing giving the full address of that other place in accordance with Section 128 of the Act.</p> <p>(c) The company may keep such books of account or other relevant papers in electronic mode in such manner as may be prescribed.</p> <p>(d) The Company shall preserve in good order the Books of Account relating to a period of not less than eight financial years immediately preceding a financial year. The books of account and other relevant books and papers maintained in electronic mode shall remain accessible in India so as to be usable for subsequent reference together with the vouchers relevant to any entry in such Books of Account.</p> <p>143 Inspection of accounts or record by members No Member (not being a director) shall have any right of inspecting any account or books or documents of the Company except as conferred by Section 94 of the Act or authorised by the Board or by the company in general meeting.</p> <p>The Board may determine whether and to what extent and at what time and place and under what conditions or regulations the accounts and books of the Company or any of them may be open to inspection of the Members. Notwithstanding anything to the contrary contained hereinabove, the authorised representative of Promoters shall have a right to inspect the accounts books, plant, facility, documents, records, premises, equipment and machinery and all other property of the Company at convenient time(s), after giving advance notice to the Company.</p> <p>144 Statement of Accounts to be furnished to General Meeting The Directors shall, from time to time, in accordance with Sections 129 and 134 and other applicable provisions of the Act, cause to be prepared and to be laid before the Company in General Meeting, such Balance Sheets, Profit and Loss Accounts and Reports as are required by these Sections.</p> <p>145 Copies shall be sent to each Member Without prejudice to the provisions of Section 101 and subject to the provisions of Section 136 of the Act, a copy of the financial statements, including consolidated financial statements, auditors' report and every other document required by law to be annexed or attached to the Balance Sheet shall at least twenty-one days before the General Body Meeting at which the same are to be laid before the members, be sent to the members of the company, to every trustee for every holder of any debenture issued by the company and to all persons other than such members or trustee, being the person so entitled to attend the General Body Meeting.</p> <p>146 Copy of financial statement to be filed with registrar The Company shall comply with Section 137 of the Act as to filing copies of the Balance Sheet and Profit and Loss Account and documents required to be annexed or attached thereto with the Registrar.</p>
			<b>Winding up</b>
<input type="checkbox"/>	<input checked="" type="checkbox"/>	87	<p>147 Procedure for winding up If the Company shall be wound up and the assets available for distribution among the members as such shall be insufficient to repay the whole of the paid up capital such assets shall be distributed so that as nearly as may be the losses shall be borne by the members in proportion to the capital paid up or which ought to have been paid up at the commencement of the winding-up on the shares held by them respectively. And if in a winding-up the assets available for distribution among the members shall be more than sufficient to repay the whole of the capital paid up at the commencement of the winding-up, the excess shall be distributed amongst the members in proportion to the capital at the commencement of the winding-up paid up or which ought to have been paid up on the shares held by them respectively. But this Article is to be without prejudice to the rights of the holders of shares issued upon special terms and conditions.</p>



55

			If the Company shall be wound up, whether voluntarily or otherwise, the liquidators may, with the sanction of a Special Resolution, divide among the contributions, in specie or kind, any part of the assets of the Company and may, with the like sanction, vest any part of the assets of the Company in Trustees upon such trusts for the benefit of the contributories, or any of them, as the liquidators, with the like sanction, shall think fit.
			<b>Indemnity</b>
<input type="checkbox"/>	<input checked="" type="checkbox"/>	88	148 Officers to be indemnified Subject to provisions of the Act, every Officer of the company shall be indemnified out of the assets of the Company against any liability incurred by him in defending any proceedings, whether civil or criminal, in which judgment is given in his favour or in which he is acquitted or in which relief is granted to him by the court or the Tribunal. Provided that if such person is proved to be guilty, the premium paid on such insurance shall be treated as part of the remuneration.
<input checked="" type="checkbox"/>			<b>Others</b>
			<p>149 Company not bound to recognize holding of shares on trust or any interest in shares other than that of registered holder Except as ordered by a Court of competent jurisdiction or as required by law, the Company shall not be bound to recognize holding of any share upon any trust and to recognize any equitable, contingent, future or partial interest in any share, or any interest in any fractional part of a share (except only as is by these Articles otherwise expressly provided) any right in respect of a share other than an absolute right thereto, in accordance with these Articles, in the person from time to time registered as the holder thereof, but the Board shall be at liberty at their sole discretion to register any share in the joint names of any two or more persons or the survivor or survivors of them.</p> <p>150 Funds etc. of Company may not be applied in purchase of shares of the Company The Company shall not give, either directly or indirectly, and either by means of a loan, guarantee, the provision of security or otherwise, any financial assistance for the purpose of or in connection with the purchase or subscription made or to be made by any person for purchase of any shares in the Company except in conformity with the provisions of Section 67 of the Act.</p> <p>151 Underwriting and Brokerage Commission may be paid</p> <p>Subject to the provisions of Section 40 of the Act, the Company may at any time pay a commission to any person in consideration of his subscribing or agreeing to subscribe for any shares in or debentures of the Company, or procuring, or agreeing to procure subscriptions for any shares in or debentures of the Company, but so that the commission shall not exceed in case of shares, five percent of the price at which the shares are issued, and in case of debentures, two and a half percent of the price at which the debentures are issued. Such commission may be satisfied by payment in cash or by allotment of fully or partly paid shares or debentures or partly in one way and partly in the other.</p> <p><b>Brokerage</b></p> <p>The Company may also on any issue of shares or debentures, pay such brokerage as may be lawful.</p> <p>152 Interest out of Capital Interest may be paid out of capital Where any shares are issued for the purpose of raising money to defray the expenses of the construction of any work or building or the provision of any plant, which cannot be made profitable for a lengthy period, the Company may pay interest on so much of that share capital as is for the time being paid up, for the period, at the rate and subject to the conditions and restrictions provided by the Company Act, 2013 and may charge the same to capital as part of the cost of construction of the work or building, or the provision of plant.</p> <p>153 Annual Returns The Company shall comply with the provisions of Sections 92 of the Act as to the making of Annual Returns.</p> <p>154 Borrowing powers As per the provisions of Section 73, 76, 179, 180 and other applicable provisions of the Act, the Board of Directors may, from time to time at its discretion, by resolution at a meeting of the Board and subject to the approval of the shareholders in General Meeting, accept deposits from Members, either in advance of calls or otherwise, and generally raise or borrow or secure the payment of any sums of money for the purpose of the Company. Provided however, where the moneys already borrowed (apart from temporary loans obtained from the Company's bankers in the ordinary due course of business) exceed the aggregate of the paid-up capital of the Company, its free reserves (not being reserves set apart for any specific purpose) and the securities premium, the Board shall not borrow such moneys without the consent of the Company in General Meeting.</p> <p style="text-align: center;">Payment or repayment of borrowed Moneys</p> <p>Subject to the provisions of Article 64 hereof, the payment and repayment of moneys borrowed as aforesaid may be secured in such manner and upon such terms and conditions in all respects as the Board of Directors may think fit, by resolutions passed at a meeting of the Board and in particular, by the issue of bonds or debentures of the Company whether unsecured or secured by a mortgage or charge over all or any part of the property of the Company (both present and future) including its uncalled capital for the time being, and debentures and other securities may be made assignable free from any equities between the Company and the person to whom the same may be issued.</p>



56

### Terms of issue of Debentures

Any debentures or other securities may be issued or otherwise and may be issued on condition that they shall be convertible into shares of any denomination, and with any privileges and conditions to redemption, surrender, drawing, allotment of shares and attending (but not voting) at General Meetings. Debentures with the right to conversion into or allotment of shares shall be issued only with the consent of the Company in General Meetings accorded by special resolution.

#### Register of charges to be Kept

The Board shall cause a proper Register to be kept in accordance with the provisions of Section 85 of the Act of all charges and floating charges affecting the property or assets of the Company or any of its undertakings and shall cause the requirements of Sections 77, 79, and 81 to 87 (both inclusive) of the Act in that behalf to be duly complied with, so far as they are required to be complied with by the Board.

#### Register of Debenture holders

The Company shall, if at any time it issues debentures, keep a Register and Index of Debenture holders in accordance with Section 88 of the Act. The Company shall have the power to keep in any Country outside India a Register of Debenture holders residing outside India, in such manner as may be prescribed.

#### Application to Debentures and other securities

The provisions of the Articles shall apply mutatis mutandis to debentures, bonds or other securities issued by the company.

#### 155 Dematerialization of Securities Definitions :

For the purpose of this Article :

?Depository? means a depository as defined in clause (e) of sub-section (1) of section 2 of the Depositories Act, 1996.

?Beneficial Owner? means a person or persons whose name is recorded in the Register maintained by a Depository under the Depository Act, 1996.

?SEBI? means the Securities and Exchange Board of India established under section 3 of the Securities & Exchange Board of India Act, 1992.

?Securities? means the securities as defined in clause (h) of section 2 of the Securities Contracts (Regulation) Act, 1956;

#### Dematerialization of Securities

Notwithstanding anything contained in these Articles, the Company shall be entitled to dematerialize its existing securities, rematerialize its securities held in the Depositories and / or offer its fresh securities in dematerialized form pursuant to the provisions of the Depositories Act, 1996 and the rules framed there under, if any.

#### Option for investors

Every person subscribing to or holding securities of the Company shall have the option to receive securities certificates or to hold the securities with the Depository. Such a person who is the beneficial owner of the securities can at any time opt out of the Depository, if permitted by the law, in respect of any security in the manner and within the time prescribed, issued to the beneficial owner the required certificate of the securities. If a person opts to hold his securities with a Depository, the Company shall intimate such Depository, the details of allotment of the security and on receipt of the information, the depository shall enter in its records the name of the allottees as the beneficial owner of the securities.

#### Securities in Depository to be in Fungible Form

All securities held by a Depository shall be dematerialized and be in fungible form. Nothing contained in Section 88, 89, 112 and 186 of the Act shall apply to a Depository in respect of the securities held by it on behalf of the Beneficial Owners.

#### Rights and Liabilities of Beneficial Owner

(a) Notwithstanding anything to the contrary contained in the Act or these Articles, a Depository shall be deemed to be the registered owner for the purposes of effecting transfer of ownership of security on behalf of the beneficial owners.

(b) Save as otherwise provided in (a) above, the Depository as the registered owner of the securities shall not have any voting rights or any other rights in respect of the securities held by it.



57

(c) Every person holding securities of the Company and whose name is entered as the beneficial owner in the records of the Depository shall be deemed to be a member of the Company. The beneficial owner of securities shall be entitled to all the rights and benefits and be subject to all the liabilities in respect of his securities, which are held, by a Depository.

#### Service of Documents

Notwithstanding anything to the contrary contained in the Act or Articles to the contrary, where securities are held in a Depository, the records of the beneficial ownership may be served by such Depository on the Company by means of electronic mode or by delivery of floppies or discs.

#### Provisions of Articles to apply to shares held in Depository

Nothing contained in Section 56 of the Act or these Articles shall apply to a transfer of securities effected by a transferor and transferee both of whom are entered as beneficial owners in the records of a Depository.

89

#### Allotment of Securities dealt within a Depository

Notwithstanding anything in the Act or these Articles, where securities are dealt with by the Depository, the Company shall intimate the details thereof to the Depository immediately on allotment of such securities.

#### Distinctive numbers of securities held in the depository Mode

Nothing contained in the Act or these Articles regarding the necessity of having distinctive numbers on securities issued by the Company shall apply to securities held with a Depository.

#### Register and Index of Beneficial Owners

The Register and Index of Beneficial Owners maintained by a Depository under the Depositories Act, 1996 shall be deemed to be the Register and Index of member and security holder for the purpose of these Articles.

156 Conversion of Shares into Stock and Reconversion Shares may be converted into stock and reconverted

The Company in General Meeting may convert any paid up shares into stock and when any shares shall have been converted into stock, the several holders of such stock may henceforth transfer their respective interest therein, or any part of such interest, in the same manner and subject to the same regulations, as if no such conversion had taken place, or as near thereto as circumstances will admit. The Company may at any time reconvert any stock into paid-up shares.

#### Rights of stock holders

The holders of stock shall, according to the amount of stock held by them, have the same rights, privileges and advantages as regards dividends, voting at meetings of the Company, and other matters, as if they held the shares from which the stock arose

157 Audit Accounts to be audited

The Auditors of the Company shall be appointed or reappointed by the Comptroller and Auditor General of India and their remuneration, rights and duties shall be regulated by Section 139 to 143 and 145 to 148 of the Act.

#### Powers of the Comptroller and Auditor General of India.

The Comptroller and Auditor General of India shall have the powers:-

(a) to direct the manner in which the Company's accounts shall be audited by the auditors appointed in pursuance of Article hereof and to give such auditors instruction in regard to any matter relating to the performance of their functions as such.

(b) to conduct a supplementary or test audit of the financial statement of the Company by such person or persons as he may authorize in this behalf, and for the purposes of such audit, to have access at all reasonable times, to all accounts, account books, vouchers, documents and other papers of the Company and to require information or additional information to be furnished to any person or persons so authorized on such matters, by such person or persons and in such form as the Comptroller and Auditor General may, by general or special order, direct.

Comments upon or supplement to audit report by the Comptroller & Auditor General of India to be placed before the annual general meeting

The auditors aforesaid shall submit a copy of his / her audit report to the Comptroller and Auditor General of India who shall have the right to comment upon or supplement such audit report in such manner as he may think fit. Any such comments upon or supplement to the audit report shall be placed before the Annual General

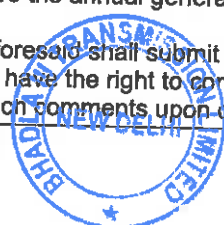

58



Meeting of the Company at the same time and in the same manner as the audit report.

158 Service of Documents  
Manner of Service of Documents

A document or notice may be served or given by the Company to any Member either through speed post, registered post or through electronic mode to his registered address or (if he has no registered address in India) to the address, if any, in India supplied by him to the Company for serving documents or notices on him. Notice is to be sent by the company through its authorized and secured computer programme which is capable of producing confirmation and keeping record of such communication addressed to the person entitled to receive such communication at the last electronic mail address provided by the member.

The notice may be sent through e-mail as a text or as an attachment to e-mail or as a notification providing electronic link or Uniform Resource Locator for accessing such notice through in-house facility or its registrar and transfer agent or authorise any third party agency providing bulk e-mail facility.  
When notices or documents served on Members

Where a document or notice is sent by post, service of the document or notice shall be deemed to be effected by properly addressing, prepaying and posting a letter containing the document or notice.

When notice or notifications of availability of notice are sent by e-mail, the company should ensure that it uses a system which produces confirmation of the total number of recipients e-mailed and a record of each recipient to whom the notice has been sent and copy of such record and any notices of any failed transmissions and subsequent re-sending shall be retained by or on behalf of the company as ??proof of sending??.

Provided that the member shall provide the updated email address to the company and for that company will provide an advance opportunity atleast once in a financial year, to the member to register his e-mail address and changes therein and such request may be made by only those members who have not got their email id recorded or to update a fresh email id. Notice will also be simultaneously updated in the website of the company.

By Advertisement

A document or notice advertised in a newspaper circulating in the neighborhood of the Registered Office shall be deemed to be duly served or sent on the day on which the advertisement appears on or to every Member who has no registered address in India and has not supplied to the Company an address within India for the serving of documents on sending the notices to him. Explanatory Statement of material facts under Section 102 need not be advertised but it will be mentioned in the advertisement that the Statement has been forwarded to the Members.

On personal representatives etc.

A document or notice may be served or given by the Company on or to the persons entitled to a share in consequence of the death or insolvency of a Member by sending it through the post in prepaid letter addressed to them by name or by the title of representative of the deceased, or assignee of the insolvent or by any like description, at the address (if any) in India supplied for the purpose by the persons claimed to be entitled, or until such an address has been so supplied by serving the document or notice in any manner in which the same might have been given if the death or insolvency had not occurred.

To whom documents or notices must be served or given

Documents or notices of every General Meeting shall be served or given in same manner as herein before or to (a) every member of the company, legal representative of any deceased member or the assignee of an insolvent member, (b) the auditor or auditors of the company; and (c) every director of the company.

Members bound by documents or notices served on or given to previous holders

Every person who, by operation of law, transfer or other means whatsoever, shall become entitled to any share, shall be bound by every document or notice in respect of such share, which previously to his name and address being entered in the Register of Members, shall have been duly served on or given to the person from whom he derives his title to such shares

Documents or notice by Company and signature thereto

Any document or notice to be served or given by the Company may be signed by a director or key managerial personnel or an officer of the company duly authorised by the Board in this behalf.

Service of document or notice by Member

All documents or notices to be served or given by Members on or to the Company or any officer thereof shall be served or given by sending it to the Company or Officer at the Office by post or through electronic mode under a certificate of posting or by registered post, or through email.

159 Secrecy (a) Every Director, Manager, Auditor, Treasurer, Trustee, member of a committee, officer, servant, agent, accountant or other person employed in the business of the Company, shall, if so





required by the Directors, before entering upon his duties, sign a declaration pledging himself to observe strict secrecy respecting all transactions and affairs of the Company with the customers and the state of the accounts with individuals and in matters relating thereto, and shall by such declaration pledge himself not to reveal any of the matters which may come to his knowledge in the discharge of his duties except when required so to do by the Directors or by law or by the person to whom such matters relate and except so far as may be necessary in order to comply with any of the provisions in these presents contained.

(b) No Member shall be entitled to visit or inspect any work of the Company without the permission of the Directors or to require discovery of or any information respecting any details of the Company's trading, or any matter which is or may be in the nature of a trade secret, mystery of trade, secret process or any other matter which may relate to the conduct of the business of the Company and which in the opinion of the Directors, it would be in expedient in the interest of the Company to disclose.

160 Copies of Memorandum and Articles of Association to be sent by the Company Copies of the Memorandum and Articles of Association of the Company and other documents referred to in Section 17 of the Act shall be sent by the Company to every Member at his request within seven days of the request on payment of such fees as may be prescribed.



Subscriber Details					
S. NO	Name, Address, Description and Occupation	DIN/PAN/Passport Number	Place	DSC	Dated
1	PFC Consulting Limited, having its Registered office at First floor, Urjanidhi, 1 Barakhamba Lane, Cannought Place ND 110001, through Sh. Manish Kumar Agarwal, S/o Shri Narender Agarwal, R/o A-3/905, Krishna Apra Garden, Vaibhav khand, Indirapuram, Ghaziabad, Uttar Pradesh 201014 Occupation Service (As Authorised Signatory of PFC Consulting Limited)	AIEPK3387Q	New Delhi	MANISH KUMAR AGARWAL <small>Digitally signed by MANISH KUMAR AGARWAL Date: 2022.05.24 12:51:41 +05'30'</small>	24/05/2022
2	Manoj Kumar Rana R/o A-32/E, DDA Flats, Munirka ND 110067 (As a Nominee of PFC Consulting Limited) Occupation: Service	02263302	New Delhi	MANOJ KUMAR RANA <small>Digitally signed by MANOJ KUMAR RANA Date: 2022.05.24 12:52:01 +05'30'</small>	24/05/2022
3	Dharuman Manavalan R/o A-703, Saheta Apartment, Plot No-30, Dwarka, Sector-4 ND 110078 (As a Nominee of PFC Consulting Limited) Occupation: Service	08102722	New Delhi	D Manavalan <small>Digitally signed by D Manavalan Date: 2022.05.24 12:53:01 +05'30'</small>	24/05/2022
4	Milind Madhusudan Dafade R/o Flat C-31, Aishwarya M Aptt. Sector-4 Plot No. 17 Dwarka ND 110078 (As a Nominee of PFC Consulting Limited) Occupation: Service	09587967	New Delhi	MILIND MADHUSUDAN DAFADE <small>Digitally signed by MILIND MADHUSUDAN DAFADE Date: 2022.05.24 12:53:11 +05'30'</small>	24/05/2022
5	Neeraj Singh R/o C-703, F-2, The Crescent Apartment, Sec-50, Noida, GB Nagar, UP 201301 (As a Nominee of PFC Consulting Limited) Occupation: Service	08613892	New Delhi	Neeraj Singh <small>Digitally signed by Neeraj Singh Date: 2022.05.24 12:53:14 +05'30'</small>	24/05/2022
6	Sanjay Nayak, R/o K-713, Jalvayu Tower, Sec-56, Gurgaon, Haryana, 122011 (As a Nominee of PFC Consulting Limited) Occupation: Service	08197193	New Delhi	SANJAY KUMAR NAYAK <small>Digitally signed by SANJAY KUMAR NAYAK Date: 2022.05.24 12:54:34 +05'30'</small>	24/05/2022
7	Sachin Shukla, R/o C 5/804 PWO Complex Sec-43, Galleria, DLF-IV, Gurgaon 122009 (As a Nominee of PFC Consulting Limited) Occupation: Service	08613963	New Delhi	Sachin Shukla <small>Digitally signed by Sachin Shukla Date: 2022.05.24 12:55:08 +05'30'</small>	24/05/2022

Signed Before Me

Name	Address, Description and Occupation	DIN/PAN/Passport Number/ Membership Number	Place	DSC	Dated
FCS Naresh Kumar Sinha	121, Vinayak Apartment, C 58/19, Sector 62, Noida 201307 U.P	1807	Noida	NARESH KUMAR SINHA <small>Digitally signed by NARESH KUMAR SINHA Date: 2022.05.24 11:52:41 +05'30'</small>	24/05/2022

Checkform

Modify



61

wish to Government claims vs fears

woman, who was also cremated, sent shockwaves, there

**HEALTH SCIENCES**  
 (PUNJAB) - 151103  
 256238

**NOTICE FOR 2ND ONLINE COUNSELLING UNDER NEET-PG-2021**

Registration/applications along with requisite fee are invited for 2nd round of online counselling from candidates who have not registered in round 1 of Punjab State counselling for MD/MS/PG/DA/DNB/PGDMS/six months training in Ultrasonography courses, through university website ([www.bfuh.s.ac.in](http://www.bfuh.s.ac.in)) from eligible dates as per Punjab Govt. notifications/prospectus on the basis of PG 2021 from 09.02.2022.

Detailed schedule of 2nd online counselling is available on university website. For detailed notices/updates, visit university website regularly.

**REGISTRAR**

**RajCOMP Info Services Limited (RISL)**  
 C-Block, 1st Floor, Yojana Bhawan, Tish Mary, C-Scheme, Jaipur.

Invites bids from the eligible bidders for the following:

Bid No./Bid No.	Particulars	Estimated Cost/EMD	Start of work / Last date
No: F4.2(348)/L/Tech/2022/8629 Date: 01.02.2022 N No.: 321228LOB00060	Request for Proposal (RFP) for Selection of Third Party Auditor (TPA) for network & collaboration projects of RISL	Rs. 15,00 Cr Rs. 30,00 Lacs	02.02.2022 15.03.2022

Bids can be seen on the websites <http://risl.rajalathan.gov.in> and <http://rajcomp.info>. Bids are to be submitted through <http://rajcomp.info>.

**GM-Technical**

**PFC CONSULTING LIMITED**  
 A wholly owned subsidiary of PFC Limited  
 Regd. Office: First Floor, Wing-A, Statesman House, Connaught Place, New Delhi-110001, India. Phone: 91-11-23443990, Fax: 91-11-23443990; e-mail: [bidproc@pfcindia.com](mailto:bidproc@pfcindia.com)

**GLOBAL INVITATION (THROUGH E-BIDDING ONLY) FOR SELECTION OF TRANSMISSION SERVICE PROVIDER ON BUILD, OWN, OPERATE AND TRANSFER (BOOT) BASIS FOR INTER-STATE TRANSMISSION PROJECT**

PFC Consulting Limited, a wholly owned subsidiary of Power Finance Corporation Limited (A Government of India Undertaking), invites proposals for setting up of transmission project on Build, Own, Operate and Transfer (BOOT) basis following single stage two envelope process of "Request for Proposal" (RFP).

Interested bidders may refer to the RFP notification and RFP documents available on the website <https://www.mscocomm.com> and <https://www.pfcindia.com>.

The Bidders may obtain the RFP documents on all working days between 10:30 hrs (IST) and 18:30 hrs (IST) from 04.02.2022 to one working day prior to bid submission for the project mentioned below on payment of a non-refundable fee of ₹5,00,000/- or USD 7,000 plus applicable GST @ 18% in the form of demand draft in favour of "PFC Consulting Limited" payable at New Delhi-110001, Tel: 91-11-23443990; Fax: 91-11-23443990; e-mail: [bidproc@pfcindia.com](mailto:bidproc@pfcindia.com). The RFP documents can also be downloaded from <https://www.mscocomm.com> and <https://www.pfcindia.com>, however, in such case, interested party can submit Response to RFP only on submission of a non-refundable fee of ₹5,00,000/- or USD 7,000 plus applicable GST @ 18% separately. The survey report and clarifications to RFP documents shall be issued to those bidders, who have obtained/purchased RFP documents by paying requisite fee at least one working day prior to bid submission date. Bidders should regularly visit website to keep themselves updated regarding clarifications/amendments/time extensions etc., if any. The important timelines in this regard are as follows:

Name of Transmission Scheme	Last Date for seeking clarifications (dd/mm/yyyy)	Last Date for submission of responses to RFP (dd/mm/yyyy)	Date of opening of Response to RFP (dd/mm/yyyy)
Transmission system for evacuation of power from REZ in Rajasthan (20GW) under Phase-III Part B1	24/02/2022	08/04/2022 up to 15:00 hrs. (IST)	08/04/2022 up to 15:30 hrs (IST)

Note: PFC Consulting Limited reserves the right to accept or modify the process without assigning any reason and without any liability.

Bid Process Co-ordinator: **PFC CONSULTING LTD**  
 (A wholly owned subsidiary of PFC Ltd.)  
 (A Govt. of India Undertaking)

An initiative of **NEW DELHI 2022**  
 Initiative Partner  
**RAJASTHAN TRANSMISSION LIMITED**  
 Ministry of Power Government of India  
 Central Electricity Authority



**Extra Financial Results**

Sr. No.	Particulars
1	Total Income from Operations
2	Net Profit / (Loss) for the period (Before Tax, Exceptional and Extraordinary Items)
3	Net Profit / (Loss) for the period before tax (After Exceptional and Extraordinary Items)
4	Net Profit / (Loss) for the period after tax (After Exceptional and Extraordinary Items)
5	Total Comprehensive Income for the period (Comprising Profit/(Loss) for the period (After tax) and Other Comprehensive Income (After tax))
6	Paid up Equity Share Capital (Face value of ₹10 each)
7	Reserves (Excluding Revaluation Reserves)
8	Securities Premium Account
9	Networth
10	Outstanding Debt
11	Outstanding Redeemable Preference Shares
12	Debt Equity Ratio (In times)
13	Earnings per share (Face Value of ₹10 each) (for continuing and discontinued operations)
	a) Basic (in ₹)
	b) Diluted (in ₹)
	(EPS for the Quarter and Nine Months not annualised)
14	Capital Redemption Reserve
15	Bond Redemption Reserve
16	Debt Service Coverage Ratio (In times)
17	Interest Service Coverage Ratio (In times)

**Notes:-**

- The above is an extract of the detailed format of financial results for the quarter 2021 filed with the Stock Exchanges under Regulation 33 and Regulation 52 (Requirements) Regulations, 2015. The full format of the financial results are available on the website ([www.mscocomm.com](http://www.mscocomm.com)) and Company's website ([www.gailindia.com](http://www.gailindia.com)).
- The above results are in accordance with the Companies (Indian Accounting Standards) Regulations, 2015, read with the relevant rules issued thereunder, which are generally accepted in India.

Place: New Delhi  
 Date: 3<sup>rd</sup> February, 2022  
[www.gailindia.com](http://www.gailindia.com) | Regd. Office: 16, Birla House, Connaught Place, New Delhi-110001, India.

Sl. No.	Particulars	Amount (in ₹)
1	Total Income from Operations	
2	Net Profit / (Loss) for the period (Before Tax, Exceptional and Extraordinary Items)	
3	Net Profit / (Loss) for the period before tax (After Exceptional and Extraordinary Items)	
4	Net Profit / (Loss) for the period after tax (After Exceptional and Extraordinary Items)	
5	Total Comprehensive Income for the period (Comprising Profit/(Loss) for the period (After tax) and Other Comprehensive Income (After tax))	
6	Paid up Equity Share Capital (Face value of ₹10 each)	
7	Reserves (Excluding Revaluation Reserves)	
8	Securities Premium Account	
9	Networth	
10	Outstanding Debt	
11	Outstanding Redeemable Preference Shares	
12	Debt Equity Ratio (In times)	
13	Earnings per share (Face Value of ₹10 each) (for continuing and discontinued operations)	
	a) Basic (in ₹)	
	b) Diluted (in ₹)	
	(EPS for the Quarter and Nine Months not annualised)	
14	Capital Redemption Reserve	
15	Bond Redemption Reserve	
16	Debt Service Coverage Ratio (In times)	
17	Interest Service Coverage Ratio (In times)	



FRIDAY, 4 FEB

502412 mmf (Bengaluru)

**PFC CONSULTING LIMITED**

(A wholly owned subsidiary of PFC Limited)  
 Plot No. 1, First Floor, "Ujjwala", 1, Bapthembhe Lane, Connaught Place,  
 New Delhi - 110061, Fax: 011-23443990

**GLOBAL INVITATION (THROUGH E-BIDDING ONLY)  
 SELECTION OF TRANSMISSION SERVICE PROVIDER  
 TO BUILD, OWN, OPERATE AND TRANSFER (BOOT) BASIS  
 FOR INTER-STATE TRANSMISSION PROJECT**

PFC Consulting Limited, a wholly owned subsidiary of Power Finance Corporation  
 (A Government of India Undertaking), invites proposals for setting up of  
 transmission project on Build, Own, Operate and Transfer (BOOT) basis following  
 the two envelope process of "Request for Proposal" (RFP).

Interested bidders may refer to the RFP notification and RFP documents  
 available on the website <https://www.mtsc.commerce.com> and  
[www.pfcindia.com](https://www.pfcindia.com).  
 Bidders may obtain the RFP documents on all working days between 10:30 hrs  
 and 18:00 hrs (IST) from 04.02.2022 to one working day prior to bid  
 deadline of the project mentioned below on payment of the  
 fee of ₹5,00,000/- or USD 7,000 plus applicable GST @18% in the  
 form of demand draft in favour of "PFC Consulting Limited" payable at  
 PFC, from 0th Floor, Wing-A, Statesman House, Connaught Place,  
 Delhi-110001, Tel.: 01-11-23443990; Fax: 01-11-23443990; e-mail:  
[cl.ttp@pfcindia.com](mailto:cl.ttp@pfcindia.com). The RFP documents can also be downloaded from  
<https://www.mtsc.commerce.com> and <https://www.pfcindia.com> on submission of  
 such case, interested party can submit Response to RFP only on submission of  
 non-refundable fee of ₹5,00,000/- or USD 7,000 plus applicable GST @18%  
 separately. The survey report and clarifications to RFP documents shall be issued to  
 interested bidders, who have obtained/purchased RFP documents by paying requisite  
 fee at least one working day prior to bid submission date. Bidders should regularly  
 visit website to keep themselves updated regarding clarifications/ amendments/ time  
 extensions etc., if any. The important timelines in this regard are as follows:

Name of Transmission Scheme	Last Date for seeking clarifications (dd/mm/yyyy)	Last Date for submission of responses to RFP (dd/mm/yyyy)	Date of opening of Responses to RFP (dd/mm/yyyy)
Transmission system for evacuation of power from REZ in Rajasthan (20GW) under Phase-III Part B1	24/02/2022	08/04/2022 up to 15:00 hrs. (IST)	08/04/2022 up to 15:30 hrs (IST)

Note: PFC Consulting Limited reserves the right to cancel or modify the process without assigning any reason and without any liability. This is not an offer.

Bid Process Coordinator  
 An Initiative of  
 Ministry of Power Government of India  
 Initiative Partner  
 Central Electricity Authority

**GUJARAT METRO RAIL CORPORATION (GMRC) LIMITED**

(SPV of Govt. of India and Govt. of Gujarat)  
 Block No.1, First Floor, Karmayogi Bhavan, Sector 10/A,  
 Gandhinagar, 382010, Gujarat. (CN): U68200GJ2010SGC059407

TENDER NOTIFICATION No: GMRC/BD & AD/MP-L5R3/2022  
 Date: 04.02.2022

E-Tenders are invited from reputed and experienced Contractors for the following tender:

Tender Name	Tender Fees
E-Tendering for "Design, Supply, Installation, Testing and Commissioning of Two Sets of Fully Automatic Train Wash Plant for Ahmedabad Metro Rail Project Phase-I"	INR 25,000/-

Interested bidders are requested to visit <https://gmrc.nprocure.com> for eligibility criteria, applying/downloading the tender document. The last date and time for Bid Submissions of Tender is till 15:00 Hrs on 16.03.2022.

Any alterations in Eligibility Criteria cum Qualification Requirements, and terms of the Tender Document, or any amendment to the Tender Document, etc., will be uploaded on <https://gmrc.nprocure.com> and GMRC's Website [www.gujaratmetrorail.com](http://www.gujaratmetrorail.com) without any obligation or press notification or other proclamation.

Sd/-  
 Managing Director,  
 GMRC, Gandhinagar

**TECHNICAL BOARD  
 OFFICE OF THE ADDITIONAL CHIEF ENGINEER, NO.2,  
 EMD, JAINA FLATS, NEW CHOKRE, NANDIYADRI, SURAT-392015**

**PRESS NOT. No. 41 (2021-22)**

S. No.	Name of Work	Amount put to tender to Tender	EMD Amount	Tender Fees	Date of release of tender in e-procurement solution	Last date/Time of receipt of tender through e-procurement solution
1	Augmentation of water supply system by P/L 150 mm and 250 mm dia GI pipe at service road from Khajoori Chowk to 5th phase Gauri road in Ghoda AC-05 Tender ID No.: 2022_DJB_215897_1	49,47,561/-	1,00,000/-	600.00	03.02.2022	17.02.2022 until 02.30 P.M

All the terms and conditions including technical specification and special conditions is available on Dohi Govt. website <https://dohi.govtprocurement.com>.  
 ISSUED BY P.R.O. (WATER)  
 Advt. No. J.S.V. 1678 (2021-22)

(V.K. Chauhan)  
 EX. ENGINEER (T)-2

**TECHNICAL BOARD  
 OFFICE OF THE ADDITIONAL CHIEF ENGINEER (T-1)  
 DELHI JAIL TOWER, GOVT. C.E.N.T. OF DELHI,  
 NO. 40, 2nd & 3rd BUILDING, JAIL ROAD, NEW DELHI-110005**

**PRESS NOT. No. 12/2021-22**

Sl No.	Name of Work	Estimated Contract Value (ECV)/Amount put to tender	Earnest Money (EMD)	Tender Fee	Date of Release of tender in E-Procurement Solution & Tender ID No.	Last Date/ Time of receipt of tender E-Procurement Solution
01	Providing laying and jointing treated effluent, water main from	3,49,31,948/-	6,99,000/-	₹ 1500/-	02.2.2022 2021 Q1R 215870	24.02.2022 At 03:00 P.M.

63

2/02

1 FEBRUARY 2022  
CHENNAI

4 FEBRUARY 2022  
MUMBAI

W 4/2

Original

**PFC CONSULTING LIMITED**  
**GLOBAL INVITATION (THROUGH E-BIDDING ONLY)**  
**FOR SELECTION OF TRANSMISSION SERVICE PROVIDER**  
**ON BUILD, OWN, OPERATE AND TRANSFER (BOOT) BASIS**  
**FOR INTER-STATE TRANSMISSION PROJECT**

PFC Consulting Limited, a wholly owned subsidiary of Power Finance Corporation Limited (A Government of India Undertaking), invites proposals for setting up of transmission project on Build, Own, Operate and Transfer (BOOT) basis following single stage two envelope process of "Request for Proposal" (RFP).  
Interested bidders may refer to the RFP notification and RFP documents available on the website <https://www.mtaocommerea.com> and <https://www.pfcindia.com>.  
The Bidders may obtain the RFP documents on all working days between 10:30 hrs (IST) and 18:00 hrs (IST) from 04.02.2022 to one working day prior to bid submission for the project mentioned below on payment of a non-refundable fee of ₹5,00,000/- or USD 7,000 plus applicable GST @18% in the form of demand draft in favour of "PFC Consulting Limited" payable at New Delhi, from 8th Floor, Wing-A, Statesman House, Connaught Place, New Delhi-110001, Tel.: 81-11-23443898; Fax: 91-11-23443890; e-mail: [pfccl.kp@pfcindia.com](mailto:pfccl.kp@pfcindia.com). The RFP documents can also be downloaded from <https://www.mtaocommerea.com> and <https://www.pfcindia.com>, however, in such case, interested party can submit response to RFP only on submission of non-refundable fee of ₹5,00,000/- or USD 7,000 plus applicable GST @18% separately. The survey report and clarifications to RFP documents by paying requisite fee at least one working day prior to bid submission date. Bidders should regularly visit website to keep themselves updated regarding clarifications/ amendments/ time extensions etc., if any. The important timelines in this regard are as follows:

Name of Transmission Scheme	Last Date for seeking clarifications (dd/mm/yyyy)	Last Date for submission of response to RFP (dd/mm/yyyy)	Date of opening of Response to RFP (dd/mm/yyyy)
Transmission system for evacuation of power from REZ in Rajasthan (20GW) under Phase-II Part B1	24/02/2022	08/04/2022 up to 15:00 hrs. (IST)	08/04/2022 up to 15:30 hrs (IST)

Note: PFC Consulting Limited reserves the right to cancel or modify the process without assigning any reason and without any liability. This is not an offer.

As Initiative of

Ministry of Power  
Government of India  
Central Electricity Authority

**RajCOMP Info Services Limited (RISL)**  
C-Block, 1st Floor, Yojana Bhawan, Tikat Marg, C-Scheme, Jaipur.

RISL invites bids from the eligible bidders for the following:

RIS No./ Date/ Unique Bid No.	Particulars	Estimated Cost/EMD	Start of bids / Last date
NHB No: F4.6(348)/RISL/Tech/2022/0529 Date: 01.02.2022 UBN No.: RIS2122SLOB00080	Request for Proposal (RFP) for Selection of Third Party Auditor (TPA) for network & collaboration projects of RISL.	Rs. 15.00 Cr Rs. 30.00 Lacs	02.02.2022 15.03.2022

Details can be seen on the websites <http://risl.rajanathan.gov.in>, <http://www.rajanathan.gov.in>, <http://data.rajanathan.gov.in>. Bids are to be submitted through <https://eproc.rajanathan.gov.in>.  
Raj.3amms4/C/21/11329

**INDRAPRASHTA GAS LIMITED**  
**NOTICE INVITING TENDER (DOMESTIC COMPETITIVE BIDDING)**  
Indraprastha Gas Limited (IGL) (CIN: L23201DL1998PLG097614) invites bids under single stage from eligible bidders for following:

Tender No.	Description of work	Tender download available from From	To	Submission of offers
GM16834	Empowerment of Advertising Agency for IGL.	04.02.2022	17.02.2022	18.02.2022 (1430 Hrs IST)

For detailed tender document, please visit [www.iglonline.net](http://www.iglonline.net). Tender document can also be collected from the office of VP (C&P and Stores), IGL Bhawan, Plot No.4, Community Centre, Sector-9, R.K.Purem, New Delhi-110 022, PH: +91 11 4807480. All subsequent changes w.r.t above tender will be posted only on the above mentioned website. Download IGL Connect App through Android Google Playstore and Apple iStore. HAR EK KAAM DESH KE NAAM

**GUJARAT METRO RAIL CORPORATION (GMRC) LIMITED**  
(SPV of Govt. of India and Govt. of Gujarat)  
Block No.1, First Floor, Karmayog Bhawan, Sector 10/A, Gandhinagar, 382010, Gujarat. (CIN: U68200GJ20103GC69407)

**TENDER NOTIFICATION No: GMRC/IGD & AD/MP/LSR/2022**  
Date: 04.02.2022

E-tenders are invited from reputed and experienced Contractors for the following tender:

Tender Name	Tender Fees
E-Tendering for "Design, Supply, Installation, Testing and Commissioning of Two Sets of Fully Automatic Train Wash Plant for Ahmedabad Metro Rail Project Phase-I"	INR 25,000/-

Interested bidders are requested to visit <https://gmrc.nprocure.com> for eligibility criteria, applying/downloading the tender document. The last date and time for Bid Submissions of Tender is till 15:00 Hrs on 16.03.2022.

Any alterations in Eligibility Criteria cum Qualification Requirements, and terms of the Tender Document, or any amendment to the Tender Document, etc, will be uploaded on <https://gmrc.nprocure.com> and GMRC's Website [www.gujaratmetrorail.com](http://www.gujaratmetrorail.com) without any obligation or press notification or other proclamation.

Sd/-  
Managing Director,  
GMRC, Gandhinagar



64

24.02.2022

24 02 2022 M 11

TED	Amount (in Rs.)
09407	0.00
172	0.00
fees	0.00
N-	
com	
The	
Hra	
nts	
der	
and	
of	



**STANDARD SINGLE STAGE REQUEST FOR PROPOSAL  
DOCUMENT**

**FOR**

**SELECTION OF BIDDER AS TRANSMISSION SERVICE PROVIDER  
THROUGH TARIFF BASED COMPETITIVE BIDDING PROCESS**

**TO**

**ESTABLISH INTER-STATE TRANSMISSION SYSTEM**

**FOR**

**TRANSMISSION SYSTEM FOR EVACUATION OF POWER FROM  
REZ IN RAJASTHAN (20GW) UNDER PHASE-III PART B1**

**ISSUED BY**



(A wholly owned subsidiary of Power Finance Corporation Ltd.)

**Registered Office:  
1st Floor, "Urjanidhi", 1, Barakhamba Lane,  
Connaught Place, New Delhi-110001**

*20..*

**February 04, 2022**

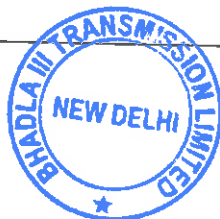

that it undertakes ownership, financing, development, design, engineering, procurement, construction, commissioning, operation and maintenance of the Project, and to provide Transmission Service as per the terms of the RFP Project Documents.

The TSP shall ensure transfer of all project assets along with substation land, right of way and clearances to CTU or its successors or an agency as decided by the Central Government after 35 years from COD of project at zero cost and free from any encumbrance and liability. The transfer shall be completed within 90 days after 35 years from COD of project failing which CTU shall be entitled to take over the project assets Suo moto.

7. **Commencement of Transmission Service:** The Bidder shall have to commence Transmission Service in accordance with the provisions of the Transmission Service Agreement.
8. **Transmission Charges:** The Transmission Charges shall be payable by the Designated ISTS Customers in Indian Rupees through the CTU as per Central Electricity Regulatory Commission (Sharing of Inter-State Transmission Charges and Losses) Regulations as amended from time to time. Bidders shall quote the Transmission Charges as per the pre-specified structure, as mentioned in the RFP.
9. **Issue of RFP document:** The detailed terms and conditions for qualification and selection of the Transmission Service Provider for the Project and for submission of Bid are indicated in the RFP document. All those interested in purchasing the RFP document may respond in writing to General Manager, Tel. +91 11 23443996, Fax +91 11 23443990, Email: [pfcl.itp@pfcindia.com](mailto:pfcl.itp@pfcindia.com) at the address given in para 12 below with a non-refundable fee of **Rs. 5,00,000/- (Rupees Five Lakh Only) or US\$ 7000/- (US Dollars Seven Thousand Only)** plus 18% GST, to be paid via electronic transfer to the following Bank Account latest by **April 07, 2022:**

**Bank Account Name : PFC Consulting Limited**  
**Account No. : 000705036117**  
**Bank Name : ICICI Bank**  
**IFSC : ICIC0000007**  
**Branch : Connaught Place, New Delhi-110001**

Immediately after issuance of RFP document, the Bidder shall submit the Pre-Award Integrity Pact in the format as prescribed in **Annexure B**, which shall be applicable for and during the bidding process, duly signed on each page by any whole-time Director / Authorized Signatory, duly witnessed by two persons, and shall be submitted by the Bidder in two (2) originals in a separate envelope, duly superscripted with Pre-Award Integrity Pact. The Bidder shall submit the Pre-Award Integrity Pact on non-judicial stamp paper of Rs. 100/- each duly purchased from the National Capital Territory of Delhi. In case the Bidder is in a consortium, the Pre-Award Integrity Pact shall be signed and submitted by each member of the Consortium separately.

The RFP document shall be issued to the Bidders on any working day from **February 04, 2022 to April 07, 2022 between 10:30 hours (IST) to 16:00 hours (IST)**. The BPC, on written request and against payment of the above mentioned fee by any Bidder shall promptly dispatch the RFP document to such Bidder by registered mail/ air mail. BPC shall, under no circumstances, be held responsible for late delivery or loss of documents so mailed.





Dated: July 25, 2023

CERTIFICATE BY THE BID EVALUATION COMMITTEE

Subject: Selection of Successful Bidder as Transmission Service Provider to establish "Transmission System for evacuation of power from REZ in Rajasthan (20 GW) under Phase-III Part B1"

It is hereby certified that:

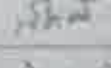
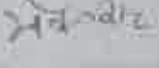
1. The entire bid process has been carried out in accordance with the "Tariff based Competitive Bidding Guidelines for Transmission Service" and "Guidelines for encouraging competition in development of the Transmission Projects" issued by Ministry of Power, Govt. of India under Section 63 of the Electricity Act, 2003 and as amended from time to time.
2. Power Grid Corporation of India Limited emerged as the Successful Bidder after the conclusion of e-reverse bidding process with the lowest Quoted Transmission Charges of Rs. 2124.08 million per annum.
3. The quoted tariff is lower than the Levelised Tariff calculated based on CERC norms considering the Capital Cost for the Project "Transmission System for evacuation of power from REZ in Rajasthan (20 GW) under Phase-III Part B1" as assessed by Cost Committee. The quoted tariff discovered through e-reverse bidding process is acceptable.

Name of BEC Members	Signature
Sh. Umesh Kumar Madan, EVP & Regional Head, SBI Capital Markets-Chairman	
Sh. Sanjiv Kumar, SE, NRPC-Member	
Sh. V.A. Kala, SE (P&P), RVPNL - Member	
Sh. Bhanwar Singh Meena, Director (PSE&TD), Central Electricity Authority-Member	
Smt. Manjari Chaturvedi, Director (PS&A-S), Central Electricity Authority, New Delhi - Member	
Sh. Milind M Dafade, Chairman, Bhaola III Transmission Limited, New Delhi - Convener Member	

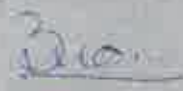



In Duplicate

Ref. No. 04/22-23/ITP-49/RFP

July 28, 2023

To,

**Power Grid Corporation of India Limited**  
"Saudamini", Plot No. 2, Sector - 29,  
Gurgaon - 122001 (Haryana)

E-mail: [sudarshan@powergrid.in](mailto:sudarshan@powergrid.in)

Kind Attn.: Mr. D. Sudharshan, Senior General Manager, Authorized Signatory

**Sub: Independent Transmission Project (ITP) "Transmission System for evacuation of power from REZ in Rajasthan (20 GW) under Phase-III Part B1" – Letter of Intent**

Dear Sir,

We refer to:

1. The Request for Proposal document dated February 04, 2022 issued to 'Power Grid Corporation of India Limited' as regards participation in the international competitive bidding process for Transmission Scheme for "Transmission System for evacuation of power from REZ in Rajasthan (20 GW) under Phase-III Part B1", and as amended till the Bid Deadline including all correspondence / clarifications / amendments exchanged between 'Power Grid Corporation of India Limited' and PFC Consulting Limited in regard thereto (hereinafter collectively referred to as the "Final RFP").
2. The offer of 'Power Grid Corporation of India Limited' by way of a Technical Bid pursuant to (1) above submitted on June 22, 2023 in response to the Final RFP.
3. The offer of 'Power Grid Corporation of India Limited' by way of Financial Bid-Initial Offer submitted on June 22, 2023 in response to the Final RFP.
4. The offer of 'Power Grid Corporation of India Limited' by way of a Financial Bid-Final Offer submitted during e-Reverse Auction process concluded on July 20, 2023 in response to the Final RFP.
5. The Technical Bid as in (2) above and the Financial Bid as in (3 & 4) above, hereinafter collectively referred to as the "Bid".

This is to inform you that the process of evaluating bids received pursuant to the Final RFP, including the Bid, has been concluded. We are pleased to inform you that your proposal and offer received by way of the "Bid" has been accepted and 'Power Grid Corporation of India Limited' is hereby declared as the Successful Bidder as per Clause 3.6.1 of the Final RFP for the above project and consequently, this Letter of Intent (hereinafter referred to as the "LoI") is being issued.

Attested from 19.68 to 71  
**ATTESTED TRUE COPY**

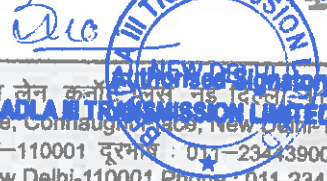



This Lol is based on the Final RFP and you are requested to please comply with the following:

- a) Acknowledging its issuance and unconditionally accepting its contents and recording "Accepted unconditionally" under the signature of your authorized signatory on each page of the duplicate copy of this letter attached herewith, and returning the same to PFC Consulting Limited within seven (07) days of the date of issuance of Lol. This Lol is issued to you in duplicate.
- b) Completion of various activities as stipulated in the Final RFP including in particular Clause 2.15.2, Clause 2.15.3 and Clause 2.15.4 of the Final RFP, within the timelines as prescribed therein.

It may be noted that PFC Consulting Limited has the rights available to them under the Final RFP, including rights under Clause 2.15.5 and Clause 3.6.3 thereof, upon your failure to comply with the aforementioned conditions.

As you are aware, the issuance and contents of this Lol are based on the Bid submitted by you as per the Final RFP including the Transmission charges and other details regarding the Scheduled COD as contained therein. The Quoted Transmission Charges as submitted by you and the Scheduled COD of each transmission Element and the Project as agreed by you in your Bid, as per Annexure 21 and Format-1 of Annexure 8 respectively of the Final RFP is annexed herewith as Schedule A and incorporated herein by way of reference.

Yours sincerely,

For PFC Consulting Limited



(Sanjay Nayak)  
General Manager

**Enclosures:** Schedule A – Quoted Transmission Charges and the Scheduled COD of each Transmission Element and the Project submitted in your Bid, as per Annexure 21 and Format-1 of Annexure 8 respectively of the Final RFP

**Copy to:**

1. **Chairman and Managing Director, Power Finance Corporation Limited, "Urjanidhi", 1, Barakhamba Lane, Connaught Lane, New Delhi – 110 001**
2. **Director (Transmission), Ministry of Power, Shram Shakti Bhawan, Rafi Marg, New Delhi- 110001**
3. **Chief Engineer (PSPA-I) and Member Secretary (NCT), Central Electricity Authority, 3<sup>rd</sup> Floor, Sewa Bhawan, R.K. Puram, New Delhi – 110066**
4. **Chief Operating Officer (COO), Central Transmission Utility of India Limited (CTUIL), "Saudamini", Plot No. 2, Sector - 29, Gurgaon, Haryana - 122001**
5. **Secretary, Central Electricity Regulatory Commission, 3rd & 4th Floor, Chanderlok Building, 36, Janpath, New Delhi – 110 001**



**1. Quoted Transmission Charges as per Annexure-21-Format For Financial Bid**

**Quoted Transmission Charges: Rs. 2124.08 million per annum**

**Notes:**

1. The Bidders are required to ensure compliance with the provisions of Clause 2.5.3 of this RFP.
2. Quotes to be in Rupees Millions and shall be up to two (2) decimal points.
3. The contents of this format shall be clearly typed.
4. The financial Bid shall be digitally signed by the authorized signatory in whose name power of attorney as per Clause 2.5.2 is issued.
5. Ensure only one value for annual Transmission Charges is quoted. The same charge shall be payable every year to TSP for the term of TSA.

*SA*



**SCHEDULE – A**

(Page 2 of 2)

**2. Scheduled COD of each transmission Element and the Project as per Format 1 of Annexure-8 of RFP**

S. No.	Name of the Transmission Element	Scheduled COD in months from Effective Date	Percentage of Quoted Transmission Charges recoverable on Scheduled COD of the Element of the Project	Element(s) which are pre-required for declaring the commercial operation (COD) of the respective Element
1.	Establishment of 2x1500 MVA 765/400kV & 3x500 MVA 400/220 kV pooling station at Bhadla-3 PS along with 2x330 MVar (765kV) Bus Reactor & 2x125 MVar (420kV) Bus Reactor	18 months	20.08%	Elements marked at Sl. No. 1, 2 & 3 are required to be commissioned simultaneously as their utilization is dependent on commissioning of each other.
2.	Bhadla-3 PS – Sikar-II S/s 765 kV D/c line along with 330 MVar Switchable line reactor for each circuit at each end of Bhadla-3 PS – Sikar-II S/s 765 kV D/c line		78.16%	
3.	2 nos. of 765kV line bays at Sikar-II S/s		1.76%	



Written clarifications on the RFP and other RFP Project Documents as per Clause 2.3 and 2.4 may be sought from:

**General Manager**  
**PFC Consulting Limited**  
9th Floor, Wing-A, Statesman House,  
Connaught Place, New Delhi - 110001  
Tel. + 91 11 23443996  
Fax + 91 11 23443990  
Email: [pfcl.itp@pfcindia.com](mailto:pfcl.itp@pfcindia.com)

## 2.15 Other Aspects

2.15.1. The draft of the Transmission Service Agreement has been attached to this RFP. In addition to above, the following documents have also been attached to this RFP:

- a) Share Purchase Agreement

When the drafts of the above RFP Project Documents are provided by the BPC, these RFP Project Documents shall form part of this RFP as per Formats – 1 & 2 of Annexure 20.

Upon finalization of the RFP Project Documents after incorporating the amendments envisaged in Clause 2.4 of this RFP, all the finalized RFP Project Documents shall be provided by BPC to the Bidders at least fifteen (15) days prior to the Bid Deadline.

The Transmission Service Agreement and Share Purchase Agreement shall be signed in required number of originals so as to ensure that one (1) original is retained by each party to the Agreement(s) on the date of transfer of SPV.

2.15.2. Within ten (10) days of the issue of the Letter of Intent, the Selected Bidder shall:

- a) provide the Contract Performance Guarantee in favour of the Nodal Agency as per the provisions of Clause 2.12;
- b) execute the Share Purchase Agreement and the Transmission Service Agreement;
- c) acquire, for the Acquisition Price, one hundred percent (100%) equity shareholding of SPV [which is under incorporation] from PFC Consulting Limited, who shall sell to the Selected Bidder, the equity shareholding of SPV [which is under incorporation], along with all its related assets and liabilities;

Stamp duties payable on purchase of one hundred percent (100%) of the equity shareholding of SPV [which is under incorporation], along with all its related assets and liabilities, shall also be borne by the Selected Bidder.

Provided further that, if for any reason attributable to the BPC, the above activities are not completed by the Selected Bidder within the above period of ten (10) days as mentioned in this Clause, such period of ten (10) days shall be extended, on a day for day basis till the end of the Bid validity period.

2.15.3. After the date of acquisition of the equity shareholding of SPV [which is under



**incorporation]**, along with all its related assets and liabilities, by the Selected Bidder,

- i. the authority of the BPC in respect of this Bid Process shall forthwith cease and any actions to be taken thereafter will be undertaken by the Nodal Agency,
  - ii. all rights and obligations of **SPV [which is under incorporation]**, shall be of the TSP,
  - iii. any decisions taken by the BPC prior to the Effective Date shall continue to be binding on the Nodal Agency and
  - iv. contractual obligations undertaken by the BPC shall continue to be fulfilled by the TSP.
  - v. Further, the TSP shall execute the Agreement(s) required, if any, under Central Electricity Regulatory Commission (Sharing of Inter-State Transmission Charges and Losses) Regulations as amended from time to time.
- 2.15.4. Within five (5) working days of the issue of the acquisition of the SPV by the Successful Bidder, the TSP shall apply to the Commission for grant of Transmission License and make an application to the Commission for the adoption of Transmission Charges, as required under Section – 63 of The Electricity Act 2003.
- 2.15.5. If the Selected Bidder / TSP fails or refuses to comply with any of its obligations under Clauses 2.15.2, 2.15.3 and 2.15.4, and provided that the other parties are willing to execute the Share Purchase Agreement and PFC Consulting Limited is willing to sell the entire equity shareholding of **SPV [which is under incorporation]**, along with all its related assets and liabilities, to the Selected Bidder, such failure or refusal on the part of the Selected Bidder shall constitute sufficient grounds for cancellation of the Letter of Intent. In such cases, the BPC / its authorized representative(s) shall be entitled to invoke the Bid Bond of the Selected Bidder.
- 2.15.6. If the TSP fails to obtain the Transmission License from the Commission, it will constitute sufficient grounds for annulment of award of the Project.
- 2.15.7. The annulment of award, as provided in Clauses 2.15.5 and 2.15.6 of this RFP, will be done by the Government on the recommendations of National Committee on Transmission. However, before recommending so, National Committee on Transmission will give an opportunity to the Selected Bidder / TSP to present their view point.
- 2.15.8. The annulment of the award, under Clause 2.15.5 or 2.15.6 of this RFP, shall be sufficient grounds for blacklisting the bidder, whose award has been annulled, for a period of five years or more, as decided by the National Committee on Transmission, provided that the blacklisting shall be done only after giving the bidder an opportunity for showing cause.

## 2.16 Confidentiality

- 2.16.1. The parties undertake to hold in confidence this RFP and RFP Project Documents and not to disclose the terms and conditions of the transaction contemplated hereby to third parties, except:

Ref. No. 04/21-22/ITP-49/RFP

September 27, 2023

To,  
Power Grid Corporation of India Limited,  
"Saudamini" Plot No 2, Sector 29,  
Gurgaon-122001

E-mail: achoudhary@powergrid.in;  
tbc@powergrid.co.in;  
sudarshan@powergrid.in  
ppandey@powergrid.in

Kind Attn.: Mr. D. Sudharshan, Senior General Manager

Sub: Independent Transmission Project "Transmission System for evacuation of power from REZ in Rajasthan (20 GW) under Phase-III Part B1" – Regarding extension of Lol.

Dear Sir,

This is with reference to Letter of Intent (LoI) issued on July 28, 2023 for establishment of subject transmission scheme. The Clause No. 2.15.2 of the RFP document stipulates that within ten (10) days of the issue of the LoI the selected bidder shall complete all the activities including the acquisition of SPV.

As the SPV is being transferred on September 27, 2023, the last date for completion of various activities under Clause No. 2.15.2 of the RFP document is extended from August 07, 2023 (10 days from LoI) to September 27, 2023.

Thanking you,

*Sanjay*

Yours faithfully,

*Sanjay*

(Sanjay Nayak)

General Manager



पंजीकृत कार्यालय : प्रथम तल "ऊर्जानिधि", 1, बाराखम्बा लेन, कर्नाट प्लेस, नई दिल्ली-110001

Regd. Office : First Floor, "Urjanidhi", 1, Barakhamba Lane, Connaught Place, New Delhi-110001

कंपनी मुख्यालय: नौवौं तल (ए विंग) स्टेट्समैन हाउस, कर्नाट प्लेस, नई दिल्ली-110001 दूरभाष : 011-23443900 फैक्स : 011-23443990

Corporate Office : 9th Floor, (A Wing) Statesman House, Connaught Place, New Delhi-110001 Phone : 011-23443900 Fax : 011-23443990

वेबसाइट/Website : www.pfcclindia.com • CIN : U74140DL2008GOI175858

74

**TRANSMISSION SERVICE AGREEMENT**

**FOR**

**DEVELOPMENT AND OPERATION OF INTER-STATE  
TRANSMISSION SYSTEM**

**FOR TRANSMISSION OF ELECTRICITY THROUGH TARIFF  
BASED COMPETITIVE BIDDING FOR**

**TRANSMISSION SYSTEM FOR EVACUATION OF POWER  
FROM REZ IN RAJASTHAN (20 GW) UNDER PHASE III –  
PART-B1**

**BETWEEN THE**

**CENTRAL TRANSMISSION UTILITY OF INDIA LIMITED  
(NODAL AGENCY)**

**AND**

**BHADLA III TRANSMISSION LIMITED**

September 27<sup>th</sup>, 2023



Attested from Pg 75 to 291

**ATTESTED TRUE COPY**



75



Transmission Service Agreement

CONTENTS

1	Definitions and Interpretations .....	6
2	Effectiveness and Term of Agreement .....	18
3	Conditions Subsequent .....	20
4	Development of the Project .....	24
5	Construction of the Project.....	28
6	Connection and commissioning of the Project.....	33
7	Operation and Maintenance of the Project.....	38
8	Availability of the project.....	39
9	Insurances .....	40
10	Billing And Payment of Transmission Charges.....	42
11	Force Majeure .....	43
12	Change in Law .....	48
13	Events of Default and Termination .....	51
14	Liability and Indemnification .....	56
15	Assignments and Charges .....	62
16	Governing Law and Dispute Resolution.....	64
17	Representation and Warranties .....	66
18	Independent Engineer .....	68
19	Miscellaneous Provisions.....	70



76



Bond



Indian-Non Judicial Stamp  
Haryana Government



Date :07/03/2023

Certificate No. G0G2023C28

GRN No. 100059695



Stamp Duty Paid : ₹ 101  
(Rs. Only)

Penalty : ₹ 0  
(Rs. Zero Only)

Deponent

Name: Central Transmission utility of India ltd

H.No/Floor : 2

Sector/Ward : 29

Landmark : Na

City/Village : Gurugram

District : Gurugram

State : Haryana

Phone : 98\*\*\*\*\*10



Purpose : ARTICLE 5 GENERAL AGREEMENT to be submitted at Concerned office

**THIS TRANSMISISON SERVICE AGREEMENT** (hereinafter referred to as "TSA" or "Agreement" or "the Agreement" or "this Agreement") is made on the 27..... [Insert day] of.....S.e.p..... [Insert month] of Two Thousand and...*twenty three*..... [Insert Year]

**BETWEEN:**

The **Central Transmission Utility of India Limited**, "Saudamini",1st Floor, Plot No. 2, Sector-29, Gurugram-122001, Haryana, acting as a Nodal Agency (referred to as the "Nodal Agency"), which expression shall unless repugnant to the context or meaning thereof include its successors, and permitted assigns) as Party of the one part;

**AND**

**Bhadla III Transmission Limited**, incorporated under the Companies Act, 2013, having its registered office at First Floor, Urjanidhi, 1 Barakhamba Lane Cannaght Place, New Delhi, Delhi Central Delhi DL 110001 (herein after referred to as "Transmission Service Provider" or "TSP" or "ISTS Licensee", which expression shall unless repugnant to the context or meaning thereof include its successors, and permitted assigns) as Party of the other part;

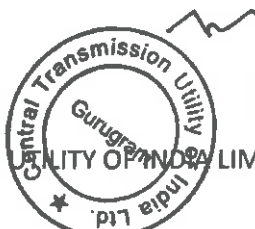

*Dio...*

Transmission Service Agreement

("Nodal Agency" and "TSP" are individually referred to as "Party" and collectively as the "Parties")

AND WHEREAS:

- A) In accordance with the Bidding Guidelines, the Bid Process Coordinator (hereinafter referred to as BPC) had initiated a competitive e-reverse bidding process through issue of RFP for selecting a Successful Bidder to build, own, operate and transfer the Project comprising of the Elements mentioned in Schedule 1 (hereinafter referred to as the Project)
- B) Pursuant to the said e-reverse bidding process, the BPC has identified the Successful Bidder, who will be responsible to set up the Project on build, own, operate and transfer basis to provide Transmission Service in accordance with the terms of this Agreement and the Transmission License.
- C) The Selected Bidder have submitted the Contract Performance Guarantee and acquired one hundred percent (100%) of the equity shareholding of **Bhadla III Transmission Limited**, along with all its related assets and liabilities in terms of the provisions of the Share Purchase Agreement.
- D) The TSP has agreed to make an application for a Transmission License to the Commission for setting up the Project on build, own, operate and transfer basis.
- E) The TSP has further agreed to make an application to the Commission for the adoption of the Transmission Charges under Section 63 of the Electricity Act, 2003, along with a certification from the Bid Evaluation Committee in accordance with the Bidding Guidelines issued by Ministry of Power, Government of India.
- F) The TSP has agreed to execute the agreement(s) required, if any, under Sharing Regulations within fifteen (15) days from the date of grant of Transmission License from the Commission.
- G) The TSP agrees to the terms and conditions laid down under Sharing Regulations, for making available the ISTS and charge the Transmission Charges in accordance with the terms and conditions of Sharing Regulations.
- H) The billing, collection and disbursement of the Transmission Charges by the CTU to the ISTS Licensee shall be governed as per Sharing Regulations.
- I) The terms and conditions stipulated in the Transmission License issued by the Commission to the TSP shall be applicable to this Agreement and the TSP agrees to comply with these terms and conditions. In case of inconsistency between the Transmission License terms & conditions and the conditions of this Agreement, the conditions stipulated in the Transmission License granted by the Commission shall prevail.

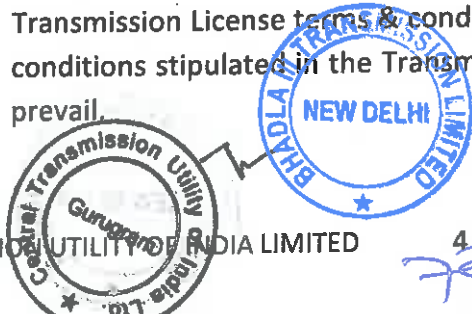

*[Handwritten Signature]*

4  
*[Handwritten Mark]*

Transmission Service Agreement

NOW, THEREFORE, IN CONSIDERATION OF THE PREMISES AND MUTUAL AGREEMENTS, COVENANTS AND CONDITIONS SET FORTH HEREIN, IT IS HEREBY AGREED BY AND BETWEEN THE PARTIES HERETO AS FOLLOWS:



5 *BF*



BHADRA III TRANSMISSION LIMITED

| September 2023

## ARTICLE: 1

### 1 DEFINITIONS AND INTERPRETATIONS

#### 1.1 Definitions:

- 1.1.1 The words / expressions used in this Agreement, unless as defined below or repugnant to the context, shall have the same meaning as assigned to them by the Electricity Act, 2003 and the rules or regulations framed there under including those issued / framed by the Commission (as defined hereunder), as amended or re-enacted from time to time or the General Clauses Act, failing which it shall bear its ordinary English meaning.

The words/expressions when used in this Agreement shall have the respective meanings as specified below:

**"Acquisition Price"** shall have the same meaning as defined in the Share Purchase Agreement;

**"Act"** or **"Electricity Act"** or **"Electricity Act 2003"** shall mean the Electricity Act, 2003 and any amendments made to the same or any succeeding enactment thereof;

**"Affiliate"** shall mean a company that either directly or indirectly

- i. controls or
- ii. is controlled by or
- iii. is under common control with

a Bidding Company (in the case of a single company) or a Member (in the case of a Consortium) and **"control"** means ownership by one entity of at least twenty six percent (26%) of the voting rights of the other entity;

**"Availability"** in relation to the Project or in relation to any Element of the Project, for a given period shall mean the time in hours during that period the Project is capable to transmit electricity at its Rated Voltage and shall be expressed in percentage of total hours in the given period and shall be calculated as per the procedure contained in **Appendix –II to Central Electricity Regulatory Commission (Terms and Conditions of Tariff) Regulations, 2019**, attached herewith in Schedule 5

**"Bid"** shall mean technical bid and financial bid submitted by the Bidder, in response to the RFP, in accordance with the terms and conditions of the RFP;

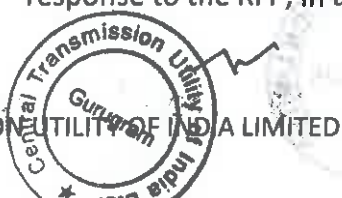

*[Handwritten signature]*



Transmission Service Agreement

**"Bid Deadline"** shall mean the last date and time for submission of the Bid in response to RFP, as specified in the RFP;

**"Bidding Company"** shall refer to such single company that has made a Response to RFP for the Project;

**"Bidding Consortium / Consortium"** shall refer to a group of companies that has collectively made a Response to RFP for the Project;

**"Bid Documents"** or **"Bidding Documents"** shall mean the RFP, along with all attachments thereto or clarifications thereof;

**"Bidding Guidelines"** shall mean the "Tariff Based Competitive Bidding Guidelines for Transmission Service" and "Guidelines for Encouraging Competition in Development of Transmission Projects" issued by Government of India, Ministry of Power under Section – 63 of the Electricity Act as amended from time to time;

**"Bid Process Coordinator"** or **"BPC"** shall mean a person or its authorized representative as notified by the Government of India, responsible for carrying out the process for selection of Bidder who will acquire Transmission Service Provider;

**"Bill"** shall mean any bill raised by the CTU on the DICs to recover the Transmission Charges pursuant to the Sharing Regulations;

**"Business Day"** shall mean a day other than Sunday or a statutory holiday, on which the banks remain open for business in the State in which the Nodal Agency's registered office is located and the concerned TSP are located;

**"CEA"** shall mean the Central Electricity Authority constituted under Section -70 of the Electricity Act;

**"Change in law"** shall have the meaning ascribed thereto in Article 12;

**"Commercial Operation Date"** or **"COD"** shall mean the date as per Article 6.2;

**"Commission"** or **"CERC"** shall mean the Central Electricity Regulatory Commission referred to in sub-section (1) of Section 76 of the Electricity Act, 2003 or its successors and assigns;

**"Competent Court of Law"** shall mean the Supreme Court or any High Court, or any tribunal or any similar judicial or quasi-judicial body in India that has jurisdiction to adjudicate upon issues relating to the Project;



Transmission Service Agreement

**"Connection Agreement"** shall mean the agreement between the CTU or STU or any other concerned parties and the TSP, setting out the terms relating to the connection of the Project to the Inter-connection Facilities and use of the Inter State Transmission System as per the provisions of the IEGC, as the case may be;

**"Consultation Period"** shall mean the period of sixty (60) days or such longer period as the Parties may agree, commencing from the date of issue of a TSP's Preliminary Notice or a Nodal Agency's Preliminary Termination Notice, as provided in Article 13 of this Agreement, for consultation between the Parties to mitigate the consequence of the relevant event having regard to all the circumstances;

**"Consents, Clearances and Permits"** shall mean all authorizations, licenses, approvals, registrations, permits, waivers, privileges, acknowledgements, agreements, or concessions required to be obtained from or provided by any concerned authority for the development, execution and operation of Project including without any limitation for the construction, ownership, operation and maintenance of the Transmission Lines and/or sub-stations;

**"Construction Period"** shall mean the period from (and including) the Effective Date of the Transmission Service Agreement up to (but not including) the COD of the Element of the Project in relation to an Element and up to (but not including) the COD of the Project in relation to the Project;

**"Contractors"** shall mean the engineering, procurement, construction, operation & maintenance contractors, surveyors, advisors, consultants, designers, suppliers to the TSP and each of their respective sub-contractors (and each of their respective successors and permitted assigns) in their respective capacities as such;

**"Contract Performance Guarantee"** shall mean the irrevocable unconditional bank guarantee, submitted and to be submitted by the TSP or by the Selected Bidder on behalf of the TSP to the Nodal Agency from a bank mentioned in Annexure 17 of the RFP, in the form attached here to as Schedule 8, in accordance with Article 3 of this Agreement and which shall include the additional bank guarantee furnished by the TSP under this Agreement;

**"Contract Year"**, for the purpose of payment of Transmission Charges, shall mean the period beginning on the COD, and ending on the immediately succeeding March 31 and thereafter each period of 12 months beginning on April 1 and ending on March 31 provided that the last Contract Year shall end on the last day of the term of the TSA;

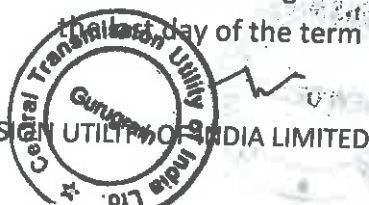

Transmission Service Agreement

“CTU” or “Central Transmission Utility” shall have same meaning as defined in the Electricity Act, 2003;

“Day” shall mean a day starting at 0000 hours and ending at 2400 hours;

“D/C” shall mean Double Circuit;

“Designated ISTS Customers” or “DICs” shall have the meaning as ascribed in the Sharing Regulations;

“Dispute” shall mean any dispute or difference of any kind between the Parties, in connection with or arising out of this Agreement including any issue on the interpretation and scope of the terms of this Agreement as provided in Article 16;

“Effective Date” for the purposes of this Agreement, shall have the same meaning as per Article 2.1 of this Agreement;

“Electrical Inspector” shall mean a person appointed as such by the Government under sub-section (1) of Section 162 of the Electricity Act 2003 and also includes Chief Electrical Inspector;

“Electricity Rules 2005” shall mean the rules framed pursuant to the Electricity Act 2003 and as amended from time to time;

“Element” shall mean each Transmission Line or each circuit of the Transmission Lines (where there are more than one circuit) or each bay of Sub-station or switching station or HVDC terminal or inverter station of the Project, including ICTs, Reactors, SVC, FSC, etc. forming part of the ISTS, which will be owned, operated and maintained by the concerned ISTS Licensee, and which has a separate Scheduled COD as per Schedule 2 of this Agreement and has a separate percentage for recovery of Transmission Charges on achieving COD as per Schedule 5 of this Agreement;

“Event of Default” shall mean the events as defined in Article 13 of this Agreement;

“Expiry Date” shall be the date which is thirty five (35) years from the COD of the Project;

“Financial Closure” shall mean the first Business Day on which funds are made available to the TSP pursuant to the Financing Agreements;



Transmission Service Agreement

**"Financially Evaluated Entity"** shall mean the company which has been evaluated for the satisfaction of the financial requirement set forth in the RFP;

**"Financing Agreements"** shall mean the agreements pursuant to which the TSP is to finance the Project including the loan agreements, security documents, notes, indentures, security agreements, letters of credit and other documents, as may be amended, modified, or replaced from time to time, but without in anyway increasing the liabilities of the Designated ISTS Customers / Nodal Agency;

**"Financial Year"** shall mean a period of twelve months at midnight Indian Standard Time (IST) between 1st April & 31st March;

**"Force Majeure"** and **"Force Majeure Event"** shall have the meaning assigned thereto in Article 11;

**"GOI"** shall mean Government of India;

**"Grid Code" / "IEGC"** shall mean the Grid Code specified by the Central Commission under Clause (h) of sub-section (1) of Section 79 of the Electricity Act;

**"Independent Engineer"** shall mean an agency/ company, appointed by Nodal Agency in accordance with the Guidelines for Encouraging Competition in Development of Transmission Projects.

**"Indian Governmental Instrumentality"** shall mean Government of India, Government of any State in India or any ministry, department, board, authority, agency, corporation, commission under the direct or indirect control of Government of India or any State Government or both, any political sub-division of any of them including any court or Commission or tribunal or judicial or quasi-judicial body in India but excluding the CTU, TSP and the Designated ISTS Customers;

**"Insurances"** shall mean the insurance cover to be obtained and maintained by the TSP in accordance with Article 9 of this Agreement;

**"Interconnection Facilities"** shall mean the facilities as may be set up for transmission of electricity through the use of the Project, on either one or both side of generating station's / CTU's / STU's / ISTS Licensee's / Designated ISTS Customer's substations (as the case may be) which shall include, without limitation, all other transmission lines, generating stations and associated equipment not forming part of the Project.

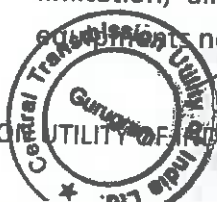

*[Handwritten signature]*

84

Transmission Service Agreement

**"ISTS Licensee"** shall be the TSP under this Agreement, consequent to having been awarded a Transmission License by the CERC and shall be referred to as the TSP or the ISTS Licensee, as the context may require in this Agreement;

**"Law" or "Laws"** in relation to this Agreement, shall mean all laws including electricity laws in force in India and any statute, ordinance, rule, regulation, notification, order or code, or any interpretation of any of them by an Indian Governmental Instrumentality having force of law and shall include all rules, regulations, decisions and orders of the Commission;

**"Lead Member of the Bidding Consortium" or "Lead Member"** shall mean a company who commits at least 26% equity stake in the Project, meets the technical requirement as specified in the RFP and so designated by other Member(s) in Bidding Consortium;

**"Lenders"** means the banks, financial institutions, multilateral funding agencies, non banking financial companies registered with the Reserve Bank of India (RBI), insurance companies registered with the Insurance Regulatory & Development Authority (IRDA), pension funds regulated by the Pension Fund Regulatory & Development Authority (PFRDA), mutual funds registered with Securities & Exchange Board of India (SEBI), etc., including their successors and assigns, who have agreed on or before COD of the Project to provide the TSP with the debt financing described in the capital structure schedule, and any successor banks or financial institutions to whom their interests under the Financing Agreements may be transferred or assigned;

Provided that, such assignment or transfer shall not relieve the TSP of its obligations to the Nodal Agency under this Agreement in any manner and shall also does not lead to an increase in the liability of the Nodal Agency;

**"Lenders Representative"** shall mean the person notified by the Lender(s) in writing as being the representative of the Lender(s) or the Security Trustee and such person may from time to time be replaced by the Lender(s) pursuant to the Financing Agreements by written notice to the TSP;

**"Letter of Intent" or "LOI"** shall have the same meaning as in the RFP;

**"Member in a Bidding Consortium / Member"** shall mean each company in the Bidding Consortium;

**"Month"** shall mean a period of thirty (30) days from (and excluding) the date of the event;



Handwritten signature and initials.



Transmission Service Agreement

**"Monthly Transmission Charges"** for any Element of the Project, after COD of the Element till COD of the Project, and for the Project after COD of the Project, shall mean the amount of Transmission Charges as specified in Schedule 5 of this Agreement multiplied by no. of days in the relevant month and divided by no. of days in the year;

**"National Load Despatch Centre"** shall mean the centre established as per sub-section (1) of Section 26 of the Electricity Act 2003;

**"Nodal Agency"** shall mean CTU, which shall execute and implement the Transmission Service Agreement (TSA);

Provided that while taking major decisions, CTU shall consult CEA on technical matters and any other matter it feels necessary.

**"Notification"** shall mean any notification, issued in the Gazette of India;

**"Operating Period"** for any Element of the Project shall mean the period from (and including) the COD of such Element of the Project, up to (and including) the Expiry Date and for the Project, shall mean the period from (and including) the COD of the Project, up to (and including) the Expiry Date;

**"Parent Company"** shall mean an entity that holds at least twenty six percent (26%) of the paid - up equity capital directly or indirectly in the Bidding Company or in the Member in a Bidding Consortium, as the case may be;

**"Preliminary Termination Notice"** shall mean a Nodal Agency's Preliminary Termination Notice as defined in Article 13 of this Agreement;

**"Project"** shall mean **"Transmission system for evacuation of power from REZ in Rajasthan (20GW) under Phase-III Part B1"**, as detailed in Schedule 1 of this Agreement;

**"Project Assets"** shall mean all physical and other assets relating to and forming part of the Project including:

- (a) rights over the Site for substations, ROW for transmission lines;
- (b) tangible & intangible assets such as civil works and equipment including foundations, embankments, pavements, electrical systems, communication systems, relief centres, administrative offices, Sub-stations, software, tower and sub-stations designs etc;

Project facilities situated on the Site;



Transmission Service Agreement

(d) all rights of the TSP under the project agreements;

(e) financial assets, such as receivables, security deposits etc;

(f) insurance proceeds; and

(g) Applicable Permits and authorisations relating to or in respect of the Transmission System;”

“Project Execution Plan” shall mean the plan referred to in Article 3.1.3(c) hereof;

“Prudent Utility Practices” shall mean the practices, methods and standards that are generally accepted internationally from time to time by electric transmission utilities for the purpose of ensuring the safe, efficient and economic design, construction, commissioning, operation, repair and maintenance of the Project and which practices, methods and standards shall be adjusted as necessary, to take account of:

- (i) operation, repair and maintenance guidelines given by the manufacturers to be incorporated in the Project,
- (ii) the requirements of Law, and
- (iii) the physical conditions at the Site;
- (iv) the safety of operating personnel and human beings;

“Rated Voltage” shall mean voltage at which the Transmission System is designed to operate or such lower voltage at which the line is charged, for the time being, in consultation with the Central Transmission Utility;

“Rebate” shall have the meaning as ascribed to in Article 10.3 of this Agreement;

“RFP” shall mean Request For Proposal dated February 4, 2022 along with all schedules, annexures and RFP Project Documents attached thereto, issued by the BPC for tariff based competitive bidding process for selection of Bidder as TSP to execute the Project, including any modifications, amendments or alterations thereto;

“RFP Project Documents” shall mean the following documents to be entered into in respect of the Project, by the Parties to the respective agreements:



Transmission Service Agreement,



*[Signature]*

BHADLA III TRANSMISSION LIMITED

1387

| September 2023

Transmission Service Agreement

- b. Share Purchase Agreement,
- c. Agreement(s) required under Sharing Regulations and
- d. Any other agreement as may be required;

“**RLDC**” shall mean the relevant Regional Load Dispatch Centre as defined in the Electricity Act, 2003, in the region(s) in which the Project is located;

“**RPC**” shall mean the relevant Regional Power Committee established by the Government of India for the specific Region(s) in accordance with the Electricity Act, 2003 for facilitating integrated operation of the Power System in that Region;

“**Scheduled COD**” in relation to an Element(s) shall mean the date(s) as mentioned in Schedule 2 as against such Element(s) and in relation to the Project, shall mean the date as mentioned in Schedule 2 as against such Project, subject to the provisions of Article 4.4 of this Agreement, or such date as may be mutually agreed among the Parties;

“**Scheduled Outage**” shall mean the final outage plan as approved by the RPC as per the provisions of the Grid Code;

“**Selected Bid**” shall mean the technical Bid and the Final Offer of the Selected Bidder submitted during e-reverse bidding, which shall be downloaded and attached in Schedule 7 on or prior to the Effective Date;

“**Share Purchase Agreement**” shall mean the agreement amongst PFC Consulting Limited (PFCCL), Bhadla III Transmission Limited and the Successful Bidder for the purchase of one hundred (100%) per cent of the shareholding of the Bhadla III Transmission Limited for the Acquisition Price, by the Successful Bidder on the terms and conditions as contained therein;

“**Sharing Regulations**” shall mean the Central Electricity Regulatory Commission (Sharing of Inter-State Transmission Charges and Losses) Regulations, 2020 and as amended from time to time;

“**Site**” in relation to a substation, switching station or HVDC terminal or inverter station, shall mean the land and other places upon which such station / terminal is to be established;

“**SLDC**” shall mean the State Load Dispatch Centre established as per sub-section (1) of Section 31 of the Electricity Act 2003;

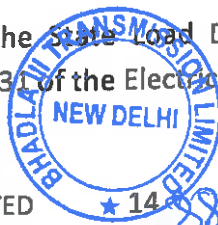
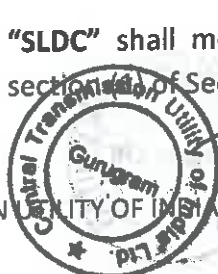

*[Signature]*

“STU” or “State Transmission Utility” shall be the Board or the Government company, specified as such by the State Government under sub-section (1) of Section 39 of the Electricity Act 2003;

“Successful Bidder” or “Selected Bidder” shall mean the Bidder selected pursuant to the RFP and who has to acquire one hundred percent (100%) equity shares of Bhadla III Transmission Limited, along with all its related assets and liabilities, which will be responsible as the TSP to establish the Project on build, own, operate and transfer basis as per the terms of the TSA and other RFP Project Documents;

“TSP’s Preliminary Notice” shall mean a notice issued by the TSP in pursuant to the provisions of Article 13.3 of this Agreement;

“Target Availability” shall have the meaning as ascribed hereto in Article 8.2 of this Agreement;

“Technically Evaluated Entity” shall mean the company which has been evaluated for the satisfaction of the technical requirement set forth in RFP;

“Termination Notice” shall mean a Nodal Agency’s Termination Notice given by the Nodal Agency to the TSP pursuant to the provisions of Articles 3.3.2, 3.3.4, 4.4.2, 5.8, 0 and 13.3 of this Agreement for the termination of this Agreement;

“Term of Agreement” for the purposes of this Agreement shall have the meaning ascribed thereto in Article 2.2 of this Agreement;

“Transmission Charges” shall mean the Final Offer of the Selected Bidder during the e-reverse bidding and adopted by the Commission, payable to the TSP as per Sharing Regulations;

“Transmission License” shall mean the license granted by the Commission in terms of the relevant regulations for grant of such license issued under the Electricity Act;

“Transmission Service” shall mean making the Project available as per the terms and conditions of this Agreement and Sharing Regulations;

“Unscheduled Outage” shall mean an interruption resulting in reduction of the Availability of the Element(s) / Project (as the case may be) that is not a result of a Scheduled Outage or a Force Majeure Event.

“Ultimate Parent Company” shall mean an entity which owns at least twenty six percent (26%) equity in the Bidding Company or Member of a Consortium, (as

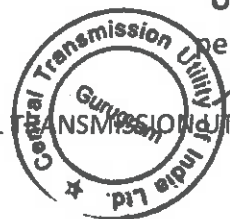

the case may be) and in the Technically Evaluated Entity and / or Financially Evaluated Entity (as the case may be) and such Bidding Company or Member of a Consortium, (as the case may be) and the Technically Evaluated Entity and / or Financially Evaluated Entity (as the case may be) shall be under the direct control or indirectly under the common control of such entity;

## 1.2 Interpretation:

*Save where the contrary is indicated, any reference in this Agreement to:*

"Agreement" shall be construed as including a reference to its Schedules, Appendices and Annexures;

"Rupee", "Rupees" and "Rs." shall denote lawful currency of India;

"crore" shall mean a reference to ten million (10,000,000) and a "lakh" shall mean a reference to one tenth of a million (1,00,000);

"encumbrance" shall be construed as a reference to a mortgage, charge, pledge, lien or other encumbrance securing any obligation of any person or any other type of preferential arrangement (including, without limitation, title transfer and retention arrangements) having a similar effect;

"holding company" of a company or corporation shall be construed as a reference to any company or corporation of which the other company or corporation is a subsidiary;

"indebtedness" shall be construed so as to include any obligation (whether incurred as principal or surety) for the payment or repayment of money, whether present or future, actual or contingent;

"person" shall have the meaning as defined in Section 2 (49) of the Act;

"subsidiary" of a company or corporation (the holding company) shall be construed as a reference to any company or corporation:

- (i) which is controlled, directly or indirectly, by the holding company, or
- (ii) more than half of the issued share capital of which is beneficially owned, directly or indirectly, by the holding company, or
- (iii) which is a subsidiary of another subsidiary of the holding company,

for these purposes, a company or corporation shall be treated as being controlled by another if that other company or corporation is able to



*[Handwritten signature]*

*90*



direct its affairs and/or to control the composition of its board of directors or equivalent body;

"winding-up", "dissolution", "insolvency", or "reorganization" in the context of a company or corporation shall have the same meaning as defined in the Companies Act, 1956/ Companies Act, 2013 (as the case may be).

- 1.2.1 Words importing the singular shall include the plural and vice versa.
- 1.2.2 This Agreement itself or any other agreement or document shall be construed as a reference to this or to such other agreement or document as it may have been, or may from time to time be, amended, varied, novated, replaced or supplemented.
- 1.2.3 A Law shall be construed as a reference to such Law including its amendments or re-enactments from time to time.
- 1.2.4 A time of day shall, save as otherwise provided in any agreement or document be construed as a reference to Indian Standard Time.
- 1.2.5 Different parts of this Agreement are to be taken as mutually explanatory and supplementary to each other and if there is any inconsistency between or among the parts of this Agreement, they shall be interpreted in a harmonious manner so as to give effect to each part.
- 1.2.6 The tables of contents and any headings or sub-headings in this Agreement have been inserted for ease of reference only and shall not affect the interpretation of this Agreement.
- 1.2.7 All interest payable under this Agreement shall accrue from day to day and be calculated on the basis of a year of three hundred and sixty five (365) days.
- 1.2.8 The words "hereof" or "herein", if and when used in this Agreement shall mean a reference to this Agreement.
- 1.2.9 The contents of Schedule 7 shall be referred to for ascertaining accuracy and correctness of the representations made by the Selected Bidder in Article 17.2.1 hereof.

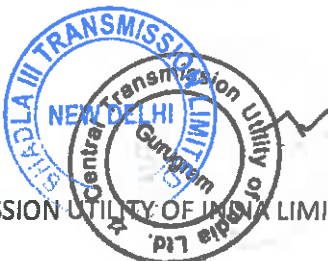

## ARTICLE: 2

### 2. EFFECTIVENESS AND TERM OF AGREEMENT

#### 2.1 Effective Date:

This Agreement shall be effective from later of the dates of the following events:

- a. The Selected Bidder, on behalf of the TSP, has provided the Contract Performance Guarantee, as per terms of Article 3.1 of this Agreement; and
- b. The Selected Bidder has acquired for the Acquisition Price, one hundred percent (100%) of the equity shareholding of **PFC Consulting Limited in Bhadla III Transmission Limited** along with all its related assets and liabilities as per the provisions of the Share Purchase Agreement. and
- c. The Agreement is executed and delivered by the Parties;

#### 2.2 Term and Termination:

2.2.1 Subject to Article 2.2.3 and Article 2.4, this Agreement shall continue to be effective in relation to the Project until the Expiry Date, when it shall automatically terminate.

2.2.2 Post the Expiry Date of this Agreement, the TSP shall ensure transfer of Project Assets to CTU or its successors or an agency as decided by the Central Government at zero cost and free from any encumbrance and liability. The transfer shall be completed within 90 days of expiry of this Agreement failing which CTU shall be entitled to take over the Project Assets Suo moto.

2.2.3 This Agreement shall terminate before the Expiry Date in accordance with Article 13 or Article 3.3.2 or Article 3.3.4.

#### 2.3 Conditions prior to the expiry of the Transmission License

2.3.1 In order to continue the Project beyond the expiry of the Transmission License, the TSP shall be obligated to make an application to the Commission at least two (2) years before the date of expiry of the Transmission License, seeking the Commission's approval for the extension of the term of the Transmission License up to the Expiry Date.

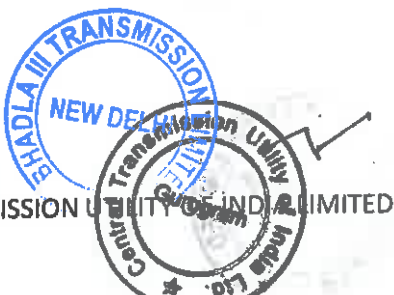

2.3.2 The TSP shall timely comply with all the requirements that may be laid down by the Commission for extension of the term of the Transmission License beyond the initial term of twenty-five (25) years & upto the Expiry Date and the TSP shall keep the Nodal Agency fully informed about the progress on its application for extension of the term of the Transmission License.

**2.4 Survival:**

The expiry or termination of this Agreement shall not affect any accrued rights, obligations/ roles and liabilities of the Parties under this Agreement, including the right to receive liquidated damages as per the terms of this Agreement, nor shall it effect the survival of any continuing obligations/ roles for which this Agreement provides, either expressly or by necessary implication, which are to survive after the Expiry Date or termination including those under Articles 3.3.3, 3.3.5, Article 9.3 (Application of Insurance Proceeds), Article 11 (Force Majeure), Article 13 (Events of Default and Termination), Article 14 (Liability & Indemnification), Article 16 (Governing Law & Dispute Resolution), Article 19 (Miscellaneous).

**2.5 Applicability of the provisions of this Agreement**

2.5.1 For the purpose of Availability, Target Availability and the computation of Availability, Incentive, Penalty, the provisions provided in this Agreement shall apply and any future modifications in the relevant Rules and Regulations shall not be applicable for this Project.

2.5.2 For the purposes of this Agreement for ISTS systems developed under the tariff based competitive bidding framework, the provisions relating to the definitions (Availability and COD), Article 3 (Contract Performance Guarantee and Conditions Subsequent), Article 5 (Construction of the Project), Article 6 (Connection and Commissioning of the Project), Article 8 (Target Availability and calculation of Availability), Article 11 (Force Majeure), Article 12 (Change in Law), Article 13 (Event of Default), Article 14 (Indemnification), Article 15 (Assignment and Charges), Articles 16.1, 16.2 and 16.4 (Governing Laws and Dispute Resolution) and Article 17 (representation and warranties of the ISTS Licensee) of this agreement shall supersede the corresponding provisions under Sharing Regulations.

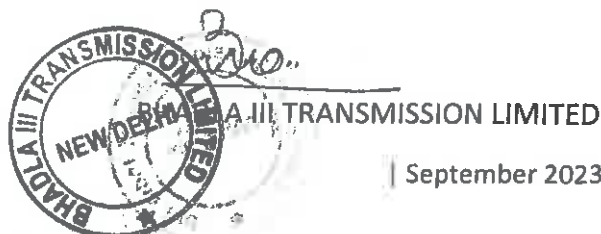

### ARTICLE: 3

#### 3. CONDITIONS SUBSEQUENT

##### 3.1 Satisfaction of conditions subsequent by the TSP

3.1.1 Within ten (10) days from the date of issue of Letter of Intent, the Selected Bidder, shall:

- a. Provide the Contract Performance Guarantee, and
- b. Acquire, for the Acquisition Price, one hundred percent (100%) equity shareholding of **Bhadla III Transmission Limited** from **PFC Consulting Limited**, who shall sell to the Selected Bidder, the equity shareholding of **Bhadla III Transmission Limited**, along with all its related assets and liabilities.
- c. Execute this Agreement;

The TSP shall, within five (5) working days from the date of acquisition of SPV by the Selected Bidder, undertake to apply to the Commission for the grant of Transmission License and for the adoption of tariff as required under section-63 of the Electricity Act.

The Selected Bidder, on behalf of the TSP, will provide to the **Central Transmission Utility of India Limited** (being the Nodal Agency) the Contract Performance Guarantee for an amount of **Rs 60 Crore (Rupees Sixty Crore Only)**.

3.1.2 The Contract Performance Guarantee shall be initially valid for a period up to three (3) months after the Scheduled COD of the Project and shall be extended from time to time to be valid for a period up to three (3) months after the COD of the Project. In case the validity of the Contract Performance Guarantee is expiring before the validity specified in this Article, the TSP shall, at least thirty (30) days before the expiry of the Contract Performance Guarantee, replace the Contract Performance Guarantee with another Contract Performance Guarantee or extend the validity of the existing Contract Performance Guarantee until the validity period specified in this Article.

3.1.3 The TSP agrees and undertakes to duly perform and complete the following activities within six (6) months from the Effective Date (except for c) below), unless such completion is affected due to any Force Majeure Event, or if any of the activities is specifically waived in writing by the Nodal Agency:

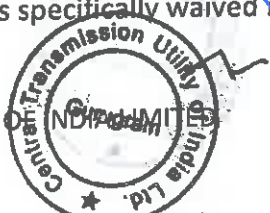

*[Handwritten signature]*

- a. To obtain the Transmission License for the Project from the Commission;
- b. To obtain the order for adoption of Transmission Charges by the Commission, as required under Section 63 of the Electricity Act 2003;
- c. To submit to the Nodal Agency, CEA & Independent Engineer, the Project Execution Plan, immediately after award of contract(s) and maximum within one hundred and twenty (120) days from the Effective Date. Also, an approved copy each of Manufacturing Quality Plan (MQP) and Field Quality Plan (FQP) would be submitted to Independent Engineer & Nodal Agency in the same time period. The TSP's Project Execution Plan should be in conformity with the Scheduled COD as specified in Schedule 2 of this Agreement, and shall bring out clearly the organization structure, time plan and methodology for executing the Project, award of major contracts, designing, engineering, procurement, shipping, construction, testing and commissioning to commercial operation;
- d. To submit to the Nodal Agency, CEA & Independent Engineer a detailed bar (GANTT) chart of the Project outlining each activity (taking longer than one Month), linkages as well as durations;
- e. To submit to the Nodal Agency, CEA & Independent Engineer detailed specifications of conductor meeting the functional specifications specified in RFP;
- f. To achieve Financial Closure;
- g. To provide an irrevocable letter to the Lenders duly accepting and acknowledging the rights provided to the Lenders under the provisions of Article 15.3 of this Agreement and all other RFP Project Documents;
- h. To award the Engineering, Procurement and Construction contract ("EPC contract") for the design and construction of the Project and shall have given to such Contractor an irrevocable notice to proceed; and
- i. To sign the Agreement(s) required, if any, under Sharing Regulations.

### 3.2 Recognition of Lenders' Rights by the Nodal Agency

- 3.2.1 The Nodal Agency hereby accepts and acknowledges the rights provided to the Lenders as per Article 15.3 of this Agreement and all other RFP Project Documents.

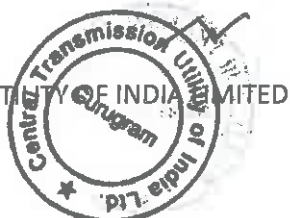

*Bio..*



**3.3 Consequences of non-fulfilment of conditions subsequent**

3.3.1 If any of the conditions specified in Article 3.1.3 is not duly fulfilled by the TSP even within three (3) Months after the time specified therein, then on and from the expiry of such period and until the TSP has satisfied all the conditions specified in Article 3.1.3, the TSP shall, on a monthly basis, be liable to furnish to **Central Transmission Utility of India Limited (being the Nodal Agency)** additional Contract Performance Guarantee of **Rs 6 Crore (Rupees Six Crore Only)** within two (2) Business Days of expiry of every such Month. Such additional Contract Performance Guarantee shall be provided to **Central Transmission Utility of India Limited (being the Nodal Agency)** in the manner provided in Article 3.1.1 and shall become part of the Contract Performance Guarantee and all the provisions of this Agreement shall be construed accordingly. **Central Transmission Utility of India Limited (being the Nodal Agency)** shall be entitled to hold and / or invoke the Contract Performance Guarantee, including such additional Contract Performance Guarantee, in accordance with the provisions of this Agreement.

3.3.2 Subject to Article 3.3.4, if:

- (i) the fulfilment of any of the conditions specified in Article 3.1.3 is delayed beyond nine (9) Months from the Effective Date and the TSP fails to furnish additional Contract Performance Guarantee to the Nodal Agency in accordance with Article 3.3.1 hereof; or
- (ii) the TSP furnishes additional Performance Guarantee to the Nodal Agency in accordance with Article 3.3.1 hereof but fails to fulfil the conditions specified in Article 3.1.3 within a period of twelve (12) months from the Effective Date,

the Nodal Agency shall have the right to terminate this Agreement, by giving a Termination Notice to the TSP, in writing, of at least seven (7) days, with a copy to CEA and the Lenders' Representative in order to enable the Lenders to exercise right of substitution in accordance with Article 15.3 of this Agreement.

3.3.3 If the Nodal Agency elects to terminate this Agreement as per the provisions of Article 3.3.2, the TSP shall be liable to pay to the Nodal Agency an amount of **Rs 60 Crore (Rupees Sixty Crore Only)** as liquidated damages. The Nodal Agency shall be entitled to recover this amount of damages by invoking the Contract Performance Guarantee to the extent of liquidated damages, which shall be required by the Nodal Agency, and the balance shall be returned to TSP, if any.

It is clarified for removal of doubt that this Article shall survive the termination of this Agreement.

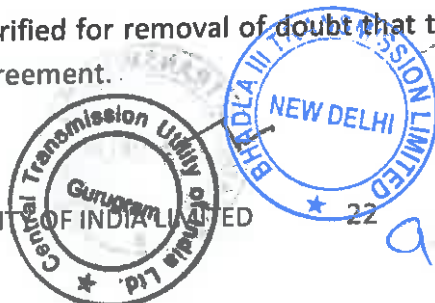

3.3.4 In case of inability of the TSP to fulfil the conditions specified in Article 3.1.3 due to any Force Majeure Event, the time period for fulfilment of the condition subsequent as mentioned in Article 3.1.3, may be extended for a period of such Force Majeure Event. Alternatively, if deemed necessary, this Agreement may be terminated by the Nodal Agency by giving a Termination Notice to the TSP, in writing, of at least seven (7) days, with a copy to CEA and the Lenders' Representative in order to enable the Lenders to exercise right of substitution in accordance with Article 15.3 of this Agreement and the Contract Performance Guarantee shall be returned as per the provisions of Article 6.5.1.

Provided, that due to the provisions of this Article 3.3.4, any increase in the time period for completion of conditions subsequent mentioned under Article 3.1.3, shall lead to an equal increase in the time period for the Scheduled COD. If the Scheduled COD is extended beyond a period of one hundred eighty (180) days due to the provisions of this Article 3.3.4, the TSP will be allowed to recover the interest cost during construction corresponding to the period exceeding one hundred eighty (180) days by adjustment in the Transmission Charges in accordance with Schedule 9.

3.3.5 Upon termination of this Agreement as per Articles 3.3.2 and 3.3.4, the Nodal Agency may take steps to bid out the Project again.

3.3.6 The Nodal agency, on the failure of the TSP to fulfil its obligations, if it considers that there are sufficient grounds for so doing, apart from invoking the Contract Performance Guarantee under para 3.3.3 may also initiate proceedings for blacklisting the TSP as per provisions of Article 13.2 of TSA.

### 3.4 Progress Reports

The TSP shall notify the Nodal Agency and CEA in writing at least once a Month on the progress made in satisfying the conditions subsequent in Articles 3.1.3.



*Bio..*

**ARTICLE: 4**

**4. DEVELOPMENT OF THE PROJECT**

**4.1 TSP's obligations in development of the Project:**

Subject to the terms and conditions of this Agreement, the TSP at its own cost and expense shall observe, comply with, perform, undertake and be responsible:

- a. for procuring and maintaining in full force and effect all Consents, Clearances and Permits, required in accordance with Law for development of the Project;
- b. for financing, constructing, owning and commissioning each of the Element of the Project for the scope of work set out in Schedule 1 of this Agreement in accordance with:
  - i. the Electricity Act and the Rules made thereof;
  - ii. the Grid Code;
  - iii. the CEA Regulations applicable, and as amended from time to time, for Transmission Lines and sub-stations:
    - the Central Electricity Authority (Technical Standards for Connectivity to the Grid) Regulations, 2007;
    - Central Electricity Authority (Technical Standards for construction of Electrical Plants and Electric Lines) Regulation, 2010;
    - Central Electricity Authority (Grid Standard) Regulations, 2010;
    - Central Electricity Authority (Safety requirements for construction, operation and maintenance of Electrical Plants and Electrical Lines) Regulation, 2011;
    - Central Electricity Authority (Measures relating to Safety and Electricity Supply) Regulation, 2010;
    - Central Electricity Authority (Technical Standards for Communication System in Power System Operation) Regulations, 2020.

iv. Safety security Guidelines laid down by the Government;

v. Prudent Utility Practices, relevant Indian Standards and the Law;

98

## Transmission Service Agreement

not later than the Scheduled COD as per Schedule 2 of this Agreement;

- c. for entering into a Connection Agreement with the concerned parties in accordance with the Grid Code.
- d. for owning the Project throughout the term of this Agreement free and clear of any encumbrances except those expressly permitted under Article 15 of this Agreement;
- e. to co-ordinate and liaise with concerned agencies and provide on a timely basis relevant information with regard to the specifications of the Project that may be required for interconnecting the Project with the Interconnection Facilities;
- f. for providing all assistance to the Arbitrators as they may require for the performance of their duties and responsibilities;
- g. to provide to the Nodal Agency and CEA, on a monthly basis, progress reports with regard to the Project and its execution (in accordance with prescribed form) to enable the CEA to monitor and co-ordinate the development of the Project matching with the Interconnection Facilities;
- h. to comply with Ministry of Power order no. 25-11/6/2018 – PG dated 02.07.2020 as well as other Guidelines issued by Govt. of India pertaining to this;
- i. to procure the products associated with the Transmission System as per provisions of Public Procurement (Preference to Make in India) orders issued by Ministry of Power vide orders No. 11/5/2018 - Coord. dated 28.07.2020 for transmission sector, as amended from time to time read with Department for Promotion of Industry and Internal Trade (DPIIT) orders in this regard (Procuring Entity as defined in above orders shall deemed to have included Selected Bidder and/ or TSP).

Also, to comply with Department of Expenditure, Ministry of Finance vide Order (Public Procurement No 1) bearing File No. 6/18/2019-PPD dated 23.07.2020, Order (Public Procurement No 2) bearing File No. 6/18/2019-PPD dated 23.07.2020 and Order (Public Procurement No. 3) bearing File No. 6/18/2019-PPD, dated 24.07.2020, as amended from time to time, regarding public procurement from a bidder of a country, which shares land border

with India,

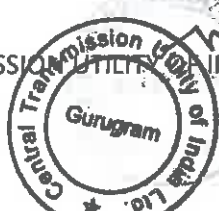

## Transmission Service Agreement

- j. to submit to Nodal Agency information in the prescribed format [To be devised by Nodal Agency] for ensuring compliance to Article 4.1 i) above.
- k. to comply with all its obligations undertaken in this Agreement.

### 4.2 Roles of the Nodal Agency in implementation of the Project:

4.2.1 Subject to the terms and conditions of this Agreement, the Nodal Agency shall be the holder and administrator of this Agreement and shall inter alia:

- a. appoint an Independent Engineer within 90 days of the Effective Date
- b. provide letters of recommendation to the concerned Indian Governmental Instrumentality, as may be requested by the TSP from time to time, for obtaining the Consents, Clearances and Permits required for the Project;
- c. coordinate among TSP and upstream/downstream entities in respect of Interconnection Facilities; and
- d. monitor the implementation of the Agreement and take appropriate action for breach thereof including revocation of guarantees, cancellation of Agreement, blacklisting etc
- e. provide all assistance to the Arbitrators as required for the performance of their duties and responsibilities; and
- f. perform any other responsibility (ies) as specified in this Agreement.

### 4.3 Time for Commencement and Completion:

- a. The TSP shall take all necessary steps to commence work on the Project from the Effective Date of the Agreement and shall achieve Scheduled COD of the Project in accordance with the time schedule specified in Schedule 2 of this Agreement;
- b. The COD of each Element of the Project shall occur no later than the Scheduled COD or within such extended time to which the TSP shall be entitled under Article 4.4 hereto.

### 4.4 Extension of time:

4.4.1 In the event that the TSP is unable to perform its obligations for the reasons solely attributable to the Nodal Agency, the Scheduled COD shall be extended, by a 'day to day' basis, subject to the provisions of Article 13.



30..

BHADLA INTER TRANSMISSION LIMITED



## Transmission Service Agreement

4.4.2 In the event that an Element or the Project cannot be commissioned by its Scheduled COD on account of any Force Majeure Event as per Article 11, the Scheduled COD shall be extended, by a 'day to day' basis for a period of such Force Majeure Event. Alternatively, if deemed necessary, the Nodal Agency may terminate the Agreement as per the provisions of Article 13.4 by giving a Termination Notice to the TSP, in writing, of at least seven (7) days, with a copy to CEA and the Lenders' Representative in order to enable the Lenders to exercise right of substitution in accordance with Article 15.3 of this Agreement.

4.4.3 If the Parties have not agreed, within thirty (30) days after the affected Party's performance has ceased to be affected by the relevant circumstance, on how long the Scheduled COD should be deferred by, any Party may raise the Dispute to be resolved in accordance with Article 16.

### 4.5 Metering Arrangements:

4.5.1 The TSP shall comply with all the provisions of the IEGC and the Central Electricity Authority (Installation and Operation of Meters) Regulations, 2006 as amended from time to time, with regard to the metering arrangements for the Project. The TSP shall fully cooperate with the CTU / STU / RLDC and extend all necessary assistance in taking meter readings.

### 4.6 Interconnection Facilities:

4.6.1 Subject to the terms and conditions of this Agreement, the TSP shall be responsible for connecting the Project with the interconnection point(s) specified in Schedule 1 of this Agreement. The Interconnection Facilities shall be developed as per the scope of work and responsibilities assigned in Schedule 1 of this Agreement. The Nodal Agency shall be responsible for coordinating to make available the Interconnection Facilities.

4.6.2 In order to remove any doubts, it is made clear that the obligation of the TSP within the scope of the project is to construct the Project as per Schedule-1 of this Agreement and in particular to connect it to the Interconnection Facilities as specified in this Agreement.



27

101



*Signature*

BDA III TRANSMISSION LIMITED

| September 2023

## ARTICLE: 5

### 5. CONSTRUCTION OF THE PROJECT

#### 5.1 TSP's Construction Responsibilities:

5.1.1 The TSP, at its own cost and expense, shall be responsible for designing, constructing, erecting, testing and commissioning each Element of the Project by the Scheduled COD in accordance with the Regulations and other applicable Laws specified in Article 4.1 of this Agreement.

5.1.2 The TSP acknowledges and agrees that it shall not be relieved from any of its obligations under this Agreement or be entitled to any extension of time or any compensation whatsoever by reason of the unsuitability of the Site or Transmission Line route(s).

5.1.3 The TSP shall be responsible for obtaining all Consents, Clearances and Permits related but not limited to road / rail / river / canal / power line / crossings, Power and Telecom Coordination Committee (PTCC), defence, civil aviation, right of way / way-leaves and environmental & forest clearances from relevant authorities required for developing, financing, constructing, maintaining/ renewing all such Consents, Clearances and Permits in order to carry out its obligations under this Agreement in general and shall furnish to the Nodal Agency such copy/ies of each Consents, Clearances and Permits, on demand. Nodal Agency shall provide letters of recommendation to the concerned Indian Governmental Instrumentality, as may be requested by the TSP from time to time, for obtaining the Consents, Clearances and Permits required for the Project.

5.1.4 The TSP shall be responsible for:

a) acquisition of land for location specific substations, switching stations or HVDC terminal or inverter stations. Also, the actual location of Greenfield substations (Switching Stations or HVDC Terminal or Inverter Stations) for a generation pooling substation and for load serving substations in the scope of TSP shall not be beyond 3 Km radius of the location proposed by the BPC in the survey report. However, actual location of any Greenfield intermediate Substations in the scope of TSP shall not be beyond 10 Km radius of the location proposed by the BPC in the Survey Report;

b) final selection of Site including its geo-technical investigation;



28



310..

BHADRACHALAM TRANSMISSION LIMITED

| September 2023

- c) survey and geo-technical investigation of line route in order to determine the final route of the Transmission Lines;
- d) seeking access to the Site and other places where the Project is being executed, at its own risk and costs, including payment of any crop, tree compensation or any other compensation as may be required.

5.1.5 In case the Project involves any resettlement and rehabilitation, the resettlement and rehabilitation package will be implemented by the State Government authorities, for which the costs is to be borne by the TSP and no changes would be allowed in the Transmission Charges on account of any variation in the resettlement and rehabilitation cost. The TSP shall provide assistance on best endeavour basis, in implementation of the resettlement and rehabilitation package, if execution of such package is in the interest of expeditious implementation of the Project and is beneficial to the Project affected persons.

## 5.2 Appointing Contractors:

- 5.2.1 The TSP shall conform to the requirements as provided in this Agreement while appointing Contractor(s) for procurement of goods & services.
- 5.2.2 The appointment of such Contractor(s) shall neither relieve the TSP of any of its obligations under this Agreement nor make the Nodal Agency liable for the performance of such Contractor(s).

## 5.3 Monthly Progress Reporting:

The TSP shall provide to the CEA, Nodal Agency & Independent Engineer, on a monthly basis, progress reports along with likely completion date of each Element with regard to the Project and its execution (in accordance with prescribed form). The Nodal Agency/ CEA shall monitor the development of the Project for its timely completion for improving and augmenting the electricity system as a part of its statutory responsibility.

## 5.4 Quality of Workmanship:

The TSP shall ensure that the Project is designed, built and completed in a good workmanship using sound engineering and construction practices, and using only materials and equipment that are new and manufactured as per the MQP and following approved FQP for erection, testing & commissioning and complying with Indian /International Standards such that, the useful life of the Project will be at least thirty five (35) years from the COD of the Project.

*2/10/23*



103



The TSP shall ensure that all major substation equipment / component (e.g. transformers, reactors, Circuit Breakers, Instrument Transformers (IT), Surge Arresters (SA), Protection relays, clamps & connectors etc.), equipment in terminal stations of HVDC installations including Thyristor/ IGBT valves, Converter Transformers, smoothing reactors, Transformer bushings and wall bushings, GIS bus ducts, towers and gantry structures and transmission towers or poles and line materials (conductors, earthwire, OPGW, insulator, accessories for conductors, OPGW & earthwires, hardware fittings for insulators, aviation lights etc), facilities and system shall be designed, constructed and tested (Type test, Routine tests, Factory Acceptance Test (FAT)) in accordance with relevant CEA Regulations and Indian Standards. In case Indian Standards for any particular equipment/ system/ process is not available, IEC/ IEEE or equivalent International Standards and Codes shall be followed.

**5.5 Progress Monitoring & Quality Assurance:**

5.5.1 The Project Execution Plan submitted by the TSP in accordance with Article 3.1.3 c) shall comprise of detailed schedule of all the equipments/items /materials required for the Project, right from procurement of raw material till the dispatch from works and receipt at the site. Further, it should also include various stages of the construction schedule up to the commissioning of the Project.

5.5.2 Nodal Agency, CEA & Independent Engineer shall have access at all reasonable times to the Site and to the Manufacturer's works and to all such places where the Project is being executed.

5.5.3 Independent Engineer shall ensure conformity of the conductor specifications with the functional specifications specified in RFP.

5.5.4 The Independent Engineer shall monitor the following during construction of the Project:

a) Quality of equipments, material, foundation, structures and workmanship etc. as laid down in Article 5.4 and 6.1.4 of the TSA. Specifically, quality of Substation equipments, transmission line material and workmanship etc. would be checked in accordance with the Article 5.4.

b) Progress in the activities specified in Condition Subsequent



*Signature*

- c) Verification of readiness of the elements including the statutory clearances & completion of civil works, fixing of all components and finalisation of punch points (if any) prior to charging of the elements
- d) Progress of construction of substation and Transmission Lines

5.5.5 The progress shall be reviewed by the Independent Engineer against the Project Execution Plan. The Independent Engineer shall prepare its report on monthly basis and submit the same to Nodal Agency highlighting the progress achieved till the end of respective month vis-à-vis milestone activities, areas of concern, if any, which may result in delay in the timely completion of the Project. Based on the progress, Nodal Agency and/ or CEA shall issue written instructions to the TSP to take corrective measures, as may be prudent for the timely completion of the Project. In case of any deficiency, the Nodal Agency would be at liberty to take action in accordance with the procedure of this Agreement.

5.5.6 For any delay in commissioning any critical Element(s), as identified in Schedule 1 & Schedule 2 of this Agreement, beyond a period of 45 days shall lead to a sequestration of 10% of the Contract Performance Guarantee.

**5.6 Site regulations and Construction Documents**

The TSP shall abide by the Safety Rules and Procedures as mentioned in Schedule 3 of this Agreement

The TSP shall retain at the Site and make available for inspection at all reasonable times, copies of the Consents, Clearances and Permits, construction drawings and other documents related to construction.

**5.7 Supervision of work:**

The TSP shall provide all necessary superintendence for execution of the Project and its supervisory personnel shall be available to provide full-time superintendence for execution of the Project. The TSP shall provide skilled personnel who are experienced in their respective fields.

**5.8 Remedial Measures:**

The TSP shall take all necessary actions for remedying the shortfall in achievement of timely progress in execution of the Project, if any, as intimated by the Independent Engineer and/ or CEA and/ or the Nodal Agency. However, such

*Duo..*

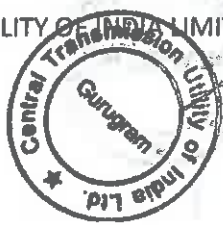



Transmission Service Agreement

intimation by the Independent Engineer and/ or CEA and/ or the Nodal Agency and the subsequent effect of such remedial measures carried out by the TSP shall not relieve the TSP of its obligations in the Agreement. Independent Engineer and/ or CEA and/ or the Nodal Agency may carry out random inspections during the Project execution, as and when deemed necessary by it. If the shortfalls as intimated to the TSP are not remedied to the satisfaction of the CEA and/ or the Nodal Agency, this Agreement may be terminated by the Nodal Agency by giving a Termination Notice to the TSP, in writing, of at least seven (7) days, with a copy to CEA and the Lenders' Representative in order to enable the Lenders to exercise right of substitution in accordance with Article 15.3 of this Agreement.

CENTRAL TRANSMISSION UTILITY CORPORATION LIMITED



106

Bra...



BRAHMA III TRANSMISSION LIMITED

| September 2023

## ARTICLE: 6

### 6. CONNECTION AND COMMISSIONING OF THE PROJECT

#### 6.1 Connection with the Inter-Connection Facilities:

6.1.1 The TSP shall give the RLDC(s), CTU, / STU, as the case may be, and any other agencies as required, at least sixty (60) days advance written notice of the date on which it intends to connect an Element of the Project, which date shall not be earlier than its Scheduled COD or Schedule COD extended as per Article 4.4.1 & 4.4.2 of this Agreement, unless mutually agreed to by Parties. Further, any preponing of COD of any element prior to Scheduled COD must be approved by the Nodal Agency.

6.1.2 The RLDC / SLDC (as the case may be) or the CTU / STU (as the case may be), for reasonable cause, including non-availability of Interconnection Facilities as per Article 4.2, can defer the connection for up to fifteen (15) days from the date notified by the TSP pursuant to Article 6.1.1, if it notifies to the TSP in writing, before the date of connection, of the reason for the deferral and when the connection is to be rescheduled. However, no such deferment on one or more occasions would be for more than an aggregate period of thirty (30) days. Further, the Scheduled COD would be extended as required, for all such deferments on "day to day" basis.

6.1.3 Subject to Articles 6.1.1 and 6.1.2, any Element of Project may be connected with the Interconnection Facilities when:

- a. it has been completed in accordance with this Agreement and the Connection Agreement;
- b. it meets the Grid Code, Central Electricity Authority (Technical Standards for Connectivity to the Grid) Regulations, 2007 as amended from time to time and all other Indian legal requirements, and
- c. The TSP has obtained the approval in writing of the Electrical Inspector certifying that the Element is ready from the point of view of safety of supply and can be connected with the Interconnection Facilities.
- d. It has satisfactorily met all the testing requirements as per Articles 6.1.4



107

6.1.4 Site Acceptance Test (SAT)/ pre-commissioning tests of all major substation equipment, component, system, facilities shall be successfully carried out before commissioning. The Type tests, FAT and SAT reports should be available at the substation / terminal station of HVDC installations for ready reference of operation and maintenance staff and has to be made available to the Independent Engineer appointed for quality monitoring or their authorised representatives, as and when they wish to examine the same.

**6.2 Commercial Operation:**

6.2.1 An Element of the Project shall be declared to have achieved COD twenty four (24) hours following the connection of the Element with the Interconnection Facilities pursuant to Article 6.1 or seven (7) days after the date on which it is declared by the TSP to be ready for charging but is not able to be charged for reasons not attributable to the TSP subject to Article 6.1.2.

Provided that an Element shall be declared to have achieved COD only after all the Element(s), if any, which are pre-required to have achieved COD as defined in Schedule 2 of this Agreement, have been declared to have achieved their respective COD.

6.2.2 Once any Element of the Project has been declared to have achieved deemed COD as per Article 6.2.1 above, such Element of the Project shall be deemed to have Availability equal to the Target Availability till the actual charging of the Element and to this extent, TSP shall be eligible for the Monthly Transmission Charges applicable for such Element.

**6.3 Compensation for Direct Non Natural Force Majeure Event or Indirect Non Natural Force Majeure Event or Natural Force Majeure Event (affecting the Nodal Agency)**

6.3.1 If the TSP is otherwise ready to connect the Element(s) of the Project and has given due notice, as per provisions of Article 6.1.1, to the concerned agencies of the date of intention to connect the Element(s) of the Project, where such date is not before the Scheduled COD, but is not able to connect the Element(s) of the Project by the said date specified in the notice, due to Direct Non Natural Force Majeure Event or Indirect Non Natural Force Majeure Event or Natural Force Majeure Event affecting the Nodal Agency, provided such Direct Non Natural Force Majeure Event or Indirect Non Natural Force Majeure Event or Natural Force Majeure Event affecting the Nodal Agency has continued for a period of more than three (3) continuous or non-continuous Months, the TSP shall, until the



effects of the Direct Non Natural Force Majeure Event or of Indirect Non Natural Force Majeure Event or Natural Force Majeure Event affecting the Nodal Agency no longer prevent the TSP from connecting the Element(s) of the Project, be deemed to have achieved COD relevant to that date and to this extent, be deemed to have been providing Transmission Service with effect from the date notified, and shall be treated as follows:

- a. In case of delay due to Direct Non Natural Force Majeure Event, TSP is entitled for Transmission Charges calculated on Target Availability for the period of such events in excess of three (3) continuous or non continuous Months in the manner provided in (c) below.
- b. In case of delay due to Indirect Non Natural Force Majeure Event or Natural Force Majeure Event affecting the Nodal Agency, TSP is entitled for payment for debt service which is due under the Financing Agreements, subject to a maximum of Transmission Charges calculated on Target Availability, for the period of such events in excess of three (3) continuous or non continuous Months in the manner provided in (c) below.
- c. In case of delay due to Direct Non Natural Force Majeure Event or Indirect Non Natural Force Majeure Event or Natural Force Majeure Event affecting the Nodal Agency, the TSP is entitled for payments mentioned in (a) and (b) above, after commencement of Transmission Service, in the form of an increase in Transmission Charges. These amounts shall be paid from the date, being the later of a) the date of cessation of such Indirect Non Natural Force Majeure Event or Natural Force Majeure Event affecting the Nodal Agency and b) the completion of sixty (60) days from the receipt of the Financing Agreements by the Nodal Agency from the TSP.

Provided such increase in Transmission Charges shall be so as to put the TSP in the same economic position as the TSP would have been in case the TSP had been paid amounts mentioned in (a) and (b) above in a situation where the Force Majeure Event had not occurred.

For the avoidance of doubt, it is clarified that the charges payable under this Article 6.3.1 shall be recovered as per Sharing Regulations.



109



**6.4 Liquidated Damages for Delay in achieving COD of Project:**

6.4.1 If the TSP fails to achieve COD of any Element of the Project or the Project, by the Element's / Project's Scheduled COD or such Scheduled COD as extended under Articles 4.4.1 and 4.4.3, then the TSP shall pay to the Nodal Agency, a sum equivalent to 3.33% of Monthly Transmission Charges applicable for the Element of the Project [in case where no Elements have been defined, to be on the Project as a whole] / Project, for each day of delay up to sixty (60) days of delay and beyond that time limit, at the rate of five percent (5%) of the Monthly Transmission Charges applicable to such Element / Project, as liquidated damages for such delay and not as penalty, without prejudice to any rights of the Nodal Agency under the Agreement.

6.4.2 The TSP's maximum liability under this Article 6.4 shall be limited to the amount of liquidated damages calculated in accordance with Article 6.4.1 for and up to six (6) months of delay for the Element or the Project.

Provided that, in case of failure of the TSP to achieve COD of the Element of the Project even after the expiry of six (6) months from its Scheduled COD, the provisions of Article 13 shall apply.

6.4.3 The TSP shall make payment to the Nodal Agency of the liquidated damages calculated pursuant to Article 6.4.1 within ten (10) days of the earlier of:

- a. the date on which the applicable Element achieves COD; or
- b. the date of termination of this Agreement.

The payment of such damages shall not relieve the TSP from its obligations to complete the Project or from any other obligation and liabilities under the Agreement.

6.4.4 If the TSP fails to pay the amount of liquidated damages to the Nodal Agency within the said period of ten (10) days, the Nodal Agency shall be entitled to recover the said amount of the liquidated damages by invoking the Contract Performance Guarantee. If the then existing Contract Performance Guarantee is for an amount which is less than the amount of the liquidated damages payable by the TSP to the Nodal Agency under this Article 6.3 and the TSP fails to make payment of the balance amount of the liquidated damages not covered by the Contract Performance Guarantee, then such balance amount shall be deducted from the Transmission Charges payable to the TSP. The right of the Nodal Agency





to encash the Contract Performance Guarantee is without prejudice to the other rights of the Nodal Agency under this Agreement.

6.4.5 For avoidance of doubt, it is clarified that amount payable by TSP under this Article is over and above the penalty payable by TSP under Article 5.5.6 of this Agreement.

## 6.5 Return of Contract Performance Guarantee

6.5.1 The Contract Performance Guarantee as submitted by TSP in accordance with Article 3.1.1 shall be released by the Nodal Agency within three (3) months from the COD of the Project. In the event of delay in achieving Scheduled COD of any of the Elements by the TSP (otherwise than due to reasons as mentioned in Article 3.1.3 or Article 11) and consequent part invocation of the Contract Performance Guarantee by the Nodal Agency, Nodal Agency shall release the Contract Performance Guarantee, if any remaining unadjusted, after the satisfactory completion by the TSP of all the requirements regarding achieving the Scheduled COD of the remaining Elements of the Project. It is clarified that the Nodal Agency shall also return / release the Contract Performance Guarantee in the event of (i) applicability of Article 3.3.2 to the extent the Contract Performance Guarantee is valid for an amount in excess of **Rs 60 Crore (Rupees Sixty Crore Only)**, or (ii) termination of this Agreement by the Nodal Agency as mentioned under Article 3.3.4 of this Agreement.

6.5.2 The release of the Contract Performance Guarantee shall be without prejudice to other rights of the Nodal Agency under this Agreement.



**ARTICLE: 7**

**7 OPERATION AND MAINTENANCE OF THE PROJECT**

**7.1 Operation and Maintenance of the Project:**

The TSP shall be responsible for ensuring that the Project is operated and maintained in accordance with the regulations made by the Commission and CEA from time to time and provisions of the Act.



38



*310.*

TRANSMISSION LIMITED

| September 2023



112

CENTRAL TRANSMISSION UTILITY COMMISSION LIMITED

## ARTICLE: 8

### 8 AVAILABILITY OF THE PROJECT

#### 8.1 Calculation of Availability of the Project:

Calculation of Availability for the Elements and for the Project, as the case may be, shall be as per Appendix –II to Central Electricity Regulatory Commission (Terms and Conditions of Tariff) Regulations, 2019, as applicable on the Bid Deadline and as appended in Schedule 6 of this Agreement.

#### 8.2 Target Availability:

The Target Availability of each Element and the Project shall be 98%.

Payment of monthly Transmission charges based on actual availability will be calculated as per para 1.2 of Schedule 4 of this Agreement.

If the availability of any Element or the Project is below the Target Availability, for six consecutive months in a Contract Year, the DIC(s) or the Nodal Agency may issue a show cause notice to the TSP, asking them to show cause as to why the Transmission Service Agreement be not terminated, and if no satisfactory cause is shown it may terminate the Agreement. If the Nodal Agency is of the opinion that the transmission system is of critical importance, it may carry out or cause to carry out the operation and maintenance of transmission system at the risk and cost of TSP.



*210*



*113*

## ARTICLE: 9

### 9 INSURANCES

#### 9.1 Insurance:

- 9.1.1 The TSP shall effect and maintain or cause to be effected and maintained during the Construction Period and the Operating Period, adequate Insurances against such risks, with such deductibles including but not limited to any third party liability and endorsements and co-beneficiary/insured, as may be necessary under
- a. any of the Financing Agreements,
  - b. the Laws, and
  - c. in accordance with Prudent Utility Practices.

The Insurances shall be taken effective from a date prior to the date of the Financial Closure till the Expiry Date.

#### 9.2 Evidence of Insurance cover:

- 9.2.1 The TSP shall furnish to the Nodal Agency copies of certificates and policies of the Insurances, as and when the Nodal Agency may seek from the TSP as per the terms of Article 9.1

#### 9.3 Application of Insurance Proceeds:

- 9.3.1 Save as expressly provided in this Agreement, the policies of Insurances and the Financing Agreements, the proceeds of any insurance claim made due to loss or damage to the Project or any part of the Project shall be first applied to reinstatement, replacement or renewal of such loss or damage.
- 9.3.2 If a Natural Force Majeure Event renders the Project no longer economically and technically viable and the insurers under the Insurances make payment on a "total loss" or equivalent basis, the portion of the proceeds of such Insurance available to the TSP (after making admissible payments to the Lenders as per the Financing Agreements) shall be allocated only to the TSP. Nodal Agency and / or concerned Designated ISTS Customers shall have no claim on such proceeds of the Insurance.
- 9.3.3 Subject to the requirements of the Lenders under the Financing Agreements, any dispute or difference between the Parties as to whether the Project is no longer economically and technically viable due to a Force Majeure Event or whether that



event was adequately covered in accordance with this Agreement by the Insurances shall be determined in accordance with Article 16.

**9.4 Effect on liability of the Nodal Agency / Designated ISTS Customers**

9.4.1 The Nodal Agency and / or the Designated ISTS Customers shall have no financial obligations or liability whatsoever towards the TSP in respect of this Article 9.

CENTRAL TRANSMISSION UTILITY OF INDIA LIMITED



41

115



*Signature*

BHADLA III TRANSMISSION LIMITED



**ARTICLE: 10**

**10 BILLING AND PAYMENT OF TRANSMISSION CHARGES**

10.1 Subject to provisions of this Article 10, the Monthly Transmission Charges shall be paid to the TSP, in Indian Rupees, on monthly basis as per the provisions of the Sharing Regulations, from the date on which an Element(s) has achieved COD until the Expiry Date of this Agreement, unless terminated earlier and in line with the provisions of Schedule 4 of this Agreement.

**10.2 Calculation of Monthly Transmission Charges:**

The Monthly Transmission Charges for each Contract Year including Incentive & Penalty payment shall be calculated in accordance with the provisions of Schedule 4 of this Agreement.

**10.3 Rebate & Late Payment Surcharge:**

The rebate and late payment surcharge shall be governed as per Sharing Regulations.

**10.4 Disputed Bills, Default in payment by the Designated ISTS Customers & Annual Reconciliation:**

Any Disputed Bill, Default in payment by the Designated ISTS Customers & Annual Reconciliation shall be governed as per Sharing Regulations.



## ARTICLE: 11

### 11 FORCE MAJEURE

#### 11.1 Definitions

11.1.1 The following terms shall have the meanings given hereunder.

#### 11.2 Affected Party

11.2.1 An Affected Party means any Party whose performance has been affected by an event of Force Majeure.

11.2.2 Any event of Force Majeure shall be deemed to be an event of Force Majeure affecting the TSP only if the Force Majeure event affects and results in, late delivery of machinery and equipment for the Project or construction, completion, commissioning of the Project by Scheduled COD and/or operation thereafter;

#### 11.3 Force Majeure

A 'Force Majeure' means any event or circumstance or combination of events and circumstances including those stated below that wholly or partly prevents or unavoidably delays an Affected Party in the performance of its obligations/ roles under this Agreement, but only if and to the extent that such events or circumstances are not within the reasonable control, directly or indirectly, of the Affected Party and could not have been avoided if the Affected Party had taken reasonable care or complied with Prudent Utility Practices:

##### a) Natural Force Majeure Events:

- i. act of God, including, but not limited to drought, fire and explosion (to the extent originating from a source external to the Site), earthquake, volcanic eruption, landslide, flood, cyclone, typhoon, tornado, or exceptionally adverse weather conditions, which are in excess of the statistical measures for the last hundred (100) years; and
- ii. epidemic/ pandemic notified by Indian Governmental Instrumentality.

##### b) Non-Natural Force Majeure Events:

- i. Direct Non-Natural Force Majeure Events
  - Nationalization or compulsory acquisition by any Indian



Governmental Instrumentality of any material assets or rights of the Affected Party; or

- the unlawful, unreasonable or discriminatory revocation of, or refusal to renew, any Consents, Clearances and Permits required by the Affected Party to perform their obligations/ roles under the RFP Project Documents or any unlawful, unreasonable or discriminatory refusal to grant any other Consents, Clearances and Permits required for the development/ operation of the Project, provided that a Competent Court of Law declares the revocation or refusal to be unlawful, unreasonable and discriminatory and strikes the same down; or
- any other unlawful, unreasonable or discriminatory action on the part of an Indian Governmental Instrumentality which is directed against the Project, provided that a Competent Court of Law declares the action to be unlawful, unreasonable and discriminatory and strikes the same down.

ii. Indirect Non - Natural Force Majeure Events

- act of war (whether declared or undeclared), invasion, armed conflict or act of foreign enemy, blockade, embargo, revolution, riot, insurrection, terrorist or military action; or
- radio active contamination or ionising radiation originating from a source in India or resulting from any other Indirect Non Natural Force Majeure Event mentioned above, excluding circumstances where the source or cause of contamination or radiation is brought or has been brought into or near the Site by the Affected Party or those employed or engaged by the Affected Party; or
- industry-wide strikes and labour disturbances, having a nationwide impact in India.

**11.4 Force Majeure Exclusions**

11.4.1 Force Majeure shall not include (i) any event or circumstance which is within the reasonable control of the Parties and (ii) the following conditions, except to the extent that they are consequences of an event of Force Majeure:



*Bio..*

SHADLA TRANSMISSION LIMITED

| September 2023

## Transmission Service Agreement

- (a) Unavailability, late delivery, or changes in cost of the machinery, equipment, materials, spare parts etc. for the Project;
- (b) Delay in the performance of any Contractors or their agents;
- (c) Non-performance resulting from normal wear and tear typically experienced in transmission materials and equipment;
- (d) Strikes or labour disturbance at the facilities of the Affected Party;
- (e) Insufficiency of finances or funds or the Agreement becoming onerous to perform; and
- (f) Non-performance caused by, or connected with, the Affected Party's:
  - i. negligent or intentional acts, errors or omissions;
  - ii. failure to comply with an Indian Law; or
  - iii. breach of, or default under this Agreement or any Project Documents.
- (g) Any error or omission in the survey report provided by BPC during the bidding process.

### 11.5 Notification of Force Majeure Event

11.5.1 The Affected Party shall give notice to the other Party of any event of Force Majeure as soon as reasonably practicable, but not later than seven (7) days after the date on which such Party knew or should reasonably have known of the commencement of the event of Force Majeure. If an event of Force Majeure results in a breakdown of communications rendering it unreasonable to give notice within the applicable time limit specified herein, then the Party claiming Force Majeure shall give such notice as soon as reasonably practicable after reinstatement of communications, but not later than one (1) day after such reinstatement.

Provided that, such notice shall be a pre-condition to the Affected Party's entitlement to claim relief under this Agreement. Such notice shall include full particulars of the event of Force Majeure, its effects on the Party claiming relief and the remedial measures proposed. The Affected Party shall give the other Party regular reports on the progress of those remedial measures and such other



information as the other Party may reasonably request about the Force Majeure.

11.5.2 The Affected Party shall give notice to the other Party of (i) the cessation of the relevant event of Force Majeure; and (ii) the cessation of the effects of such event of Force Majeure on the performance of its rights or obligations/ roles under this Agreement, as soon as practicable after becoming aware of each of these cessations.

#### 11.6 Duty to perform and duty to mitigate

To the extent not prevented by a Force Majeure Event, the Affected Party shall continue to perform its obligations/ roles as provided in this Agreement. The Affected Party shall use its reasonable efforts to mitigate the effect of any event of Force Majeure as soon as practicable.

#### 11.7 Available Relief for a Force Majeure Event

Subject to this Article 11,

- (a) no Party shall be in breach of its obligations/ roles pursuant to this Agreement to the extent that the performance of its obligations/ roles was prevented, hindered or delayed due to a Force Majeure Event;
- (b) each Party shall be entitled to claim relief for a Force Majeure Event affecting its performance in relation to its obligations/ roles under Articles 3.3.4, 4.4.2 and 6.3.1 of this Agreement.
- (c) For the avoidance of doubt, it is clarified that the computation of Availability of the Element(s) under outage due to Force Majeure Event, as per Article 11.3 affecting the TSP shall be as per **Appendix-II to Central Electricity Regulatory Commission (Terms and Conditions of Tariff) Regulations, 2019** as on Bid Deadline. For the event(s) for which the Element(s) is/are deemed to be available as per **Appendix -II to Central Electricity Regulatory Commission (Terms and Conditions of Tariff) Regulations, 2019**, then the Transmission Charges, as applicable to such Element(s), shall be payable as per Schedule 4, for the duration of such event(s).
- (d) For so long as the TSP is claiming relief due to any Force Majeure Event under this Agreement, the Nodal Agency may, if it so desires, from time to time on one (1) day notice, inspect the Project and the TSP shall provide the Nodal Agency's personnel with access to the Project to carry out such inspections.

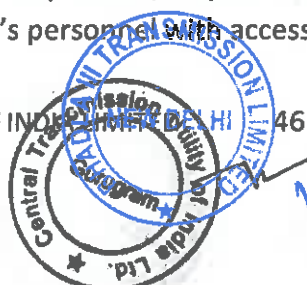



Transmission Service Agreement

- (e) For avoidance of doubt, the TSP acknowledges that for extension of Scheduled COD a period up to one hundred eighty (180) days due to Force Majeure event, no compensation on the grounds such as interest cost, incident expenditure, opportunity cost will be made to the TSP. However, if Scheduled COD is extended beyond a period of one hundred eighty (180) days due to Force Majeure event, the TSP will be allowed to recover the interest cost during construction corresponding to the period exceeding one hundred eighty (180) days by adjustment in the Transmission Charges in accordance with Schedule 9.



121



## ARTICLE: 12

### 12 CHANGE IN LAW

#### 12.1 Change in Law

12.1.1 Change in Law means the occurrence of any of the following after the Bid Deadline resulting into any additional recurring / non-recurring expenditure by the TSP or any savings of the TSP:

- the enactment, coming into effect, adoption, promulgation, amendment, modification or repeal (without re-enactment or consolidation) in India, of any Law, including rules and regulations framed pursuant to such Law, subject to the provisions under Article 12.1.2;
- a change in the interpretation or application of any Law by any Indian Governmental Instrumentality having the legal power to interpret or apply such Law, or any Competent Court of Law;
- the imposition of a requirement for obtaining any Consents, Clearances and Permits which was not required earlier;
- a change in the terms and conditions prescribed for obtaining any Consents, Clearances and Permits or the inclusion of any new terms or conditions for obtaining such Consents, Clearances and Permits;
- any change in the licensing regulations of the Commission, under which the Transmission License for the Project was granted if made applicable by such Commission to the TSP;
- change in wind zone; or
- any change in tax or introduction of any tax made applicable for providing Transmission Service by the TSP as per the terms of this Agreement.

12.1.2 Notwithstanding anything contained in this Agreement, Change in Law shall not cover any change:

- a) Taxes on corporate income; and
- b) Withholding tax on income or dividends distributed to the shareholders of the TSP.



*[Handwritten signature]*

**12.2 Relief for Change in Law**

12.2.1 During Construction Period, the impact of increase/decrease in the cost of the Project on the Transmission Charges shall be governed by the formula given in Schedule 9 of this Agreement

12.2.2 During the Operation Period:

During the operation period, if as a result of Change in Law, the TSP suffers or is benefited from a change in costs or revenue, the aggregate financial effect of which exceeds 0.30% (zero point three percent) of the Annual Transmission Charges in aggregate for a Contract Year, the TSP may notify so to the Nodal Agency and propose amendments to this Agreement so as to place the TSP in the same financial position as it would have enjoyed had there been no such Change in Law resulting in change in costs or revenue as aforesaid.

12.2.3 For any claims made under Articles 12.2.1 and 12.2.2 above, the TSP shall provide to the Nodal Agency documentary proof of such increase / decrease in cost of the Project / revenue for establishing the impact of such Change in Law.

In cases where Change in Law results in decrease of cost and it comes to the notice of Nodal Agency that TSP has not informed Nodal Agency about such decrease in cost, Nodal Agency may initiate appropriate claim.

**12.3 Notification of Change in Law:**

12.3.1 If the TSP is affected by a Change in Law in accordance with Article 12.1 and wishes to claim relief for such Change in Law under this Article 12, it shall give notice to Nodal Agency of such Change in Law as soon as reasonably practicable after becoming aware of the same.

12.3.2 The TSP shall also be obliged to serve a notice to the Nodal Agency even when it is beneficially affected by a Change in Law.

12.3.3 Any notice served pursuant to Articles 12.3.1 and 12.3.2 shall provide, amongst other things, precise details of the Change in Law and its estimated impact on the TSP.



**12.4 Payment on account of Change in Law**

12.4.1 The payment for Change in Law shall be through a separate Bill. However, in case of any change in Monthly Transmission Charges by reason of Change in Law, as determined in accordance with this Agreement, the Bills to be raised by the Nodal Agency after such change in Transmission Charges shall appropriately reflect the changed Monthly Transmission Charges.



## ARTICLE: 13

### 13 EVENTS OF DEFAULT AND TERMINATION

#### 13.1 TSP's Event of Default

The occurrence and continuation of any of the following events shall constitute a TSP Event of Default, unless any such TSP Event of Default occurs as a result of any non-fulfilment of its obligations as prescribed under this Agreement by the Nodal Agency or a Force Majeure Event:

- a. After having taken up the construction of the Project, the abandonment by the TSP or the TSP's Contractors of the construction of the Project for a continuous period of two (2) months and such default is not rectified within thirty (30) days from the receipt of notice from the Nodal Agency in this regard;
- b. The failure to commission any Element of the Project by the date falling six (6) months after its Scheduled COD unless extended by Nodal Agency as per provisions of this Agreement;
- c. If the TSP:
  - i. assigns, mortgages or charges or purports to assign, mortgage or charge any of its assets or rights related to the Project in contravention of the provisions of this Agreement; or
  - ii. transfers or novates any of its obligations pursuant to this Agreement, in a manner contrary to the provisions of this Agreement;

Except where such transfer is in pursuance of a Law and

- it does not affect the ability of the transferee to perform, and such transferee has the financial and technical capability to perform, its obligations under this Agreement;
- is to a transferee who assumes such obligations under the Project and this Agreement remains effective with respect to the transferee;





Transmission Service Agreement

- d. If:
- i. The TSP becomes voluntarily or involuntarily the subject of any bankruptcy or insolvency or winding up proceedings and such proceedings remain uncontested for a period of thirty (30) days; or
  - ii. any winding up or bankruptcy or insolvency order is passed against the TSP; or
  - iii. the TSP goes into liquidation or dissolution or a receiver or any similar officer is appointed over all or substantially all of its assets or official liquidator is appointed to manage its affairs, pursuant to Law,

Provided that a dissolution or liquidation of the TSP will not be a TSP's Event of Default, where such dissolution or liquidation of the TSP is for the purpose of a merger, consolidation or reorganization with the prior approval of the Commission as per the provisions of Central Electricity Regulatory Commission (Procedure, terms and Conditions for grant of Transmission License and other related matters) Regulations, 2006 or as amended from time to time; or

- e. Failure on the part of the TSP to comply with the provisions of Article 19.1 of this Agreement; or
- f. the TSP repudiates this Agreement and does not rectify such breach even within a period of thirty (30) days from a notice from the Nodal Agency in this regard; or
- g. after Commercial Operation Date of the Project, the TSP fails to achieve monthly Target Availability of 98% for a period of six (6) consecutive months or within a non-consecutive period of six (6) months within any continuous aggregate period of eighteen(18) months except where the Availability is affected by Force Majeure Events as per Article 11; or
- h. any of the representations and warranties made by the TSP in Article 17 of this Agreement being found to be untrue or inaccurate. Further, in addition to the above, any of the undertakings submitted by the Selected Bidder at the time of submission of the Bid being



found to be breached or inaccurate, including but not limited to undertakings from its Parent Company / Affiliates related to the minimum equity obligation; or

- i. the TSP fails to complete / fulfil all the activities / conditions within the specified period as per Article 3; or
- j. except for the reasons solely attributable to Nodal Agency, the TSP is in material breach of any of its obligations under this Agreement and such material breach is not rectified by the TSP within thirty (30) days of receipt of notice in this regard from the Nodal Agency; or
- k. the TSP fails to take the possession of the land required for location specific substations, switching stations or HVDC terminal or inverter stations and / or fails to pay the requisite price to the parties and / or any State Government authority from whom the land is acquired, within twelve (12) months from the Effective Date.

**13.2 Termination Procedure for TSP Event of Default**

- a. Upon the occurrence and continuance of any TSP's Event of Default under Article 13.1 the Nodal Agency may serve notice on the TSP, with a copy to the CEA and the Lenders' Representative, of their intention to terminate this Agreement (a "Nodal Agency's Preliminary Termination Notice"), which shall specify in reasonable detail, the circumstances giving rise to such Nodal Agency's Preliminary Termination Notice.
- b. Following the issue of a Nodal Agency's Preliminary Termination Notice, the Consultation Period shall apply and would be for the Parties to discuss as to what steps shall be taken with a view to mitigate the consequences of the relevant Event of Default having regard to all the circumstances.
- c. During the Consultation Period, the Parties shall, save as otherwise provided in this Agreement, continue to perform their respective obligations/ roles under this Agreement, and the TSP shall not remove any material, equipment or any part of the Project, without prior consent of the Nodal Agency.

Following the expiry of the Consultation Period, unless the Parties shall have otherwise agreed to the contrary or the circumstances giving rise to

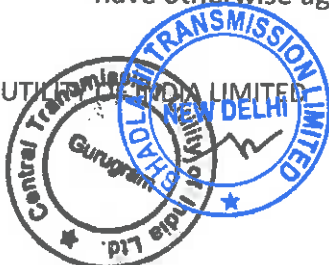

Nodal Agency's Preliminary Termination Notice shall have ceased to exist or shall have been remedied, this Agreement may be terminated by the Nodal Agency by giving a Termination Notice to the TSP, in writing, of at least seven (7) days, with a copy to CEA and the Lenders' Representative in order to enable the Lenders to exercise right of substitution in accordance with Article 15.3 of this Agreement.

Further, the Nodal Agency may also initiate proceedings to blacklist the TSP & its Affiliates from participation in any RFP issued by BPCs for a period of 5 years.

### **13.3 Procedure for Nodal Agency's non-fulfilment of Role**

- a. Upon the Nodal Agency not being able to fulfil its role under Article 4.2, the TSP may serve notice on the Nodal Agency, with a copy to CEA and the Lenders' Representative (a "TSP's Preliminary Notice"), which notice shall specify in reasonable detail the circumstances giving rise to such non-fulfilment of role by the Nodal Agency.
- b. Following the issue of a TSP's Preliminary Notice, the Consultation Period shall apply.
- c. The Consultation Period would be for the Parties to discuss as to what steps shall be taken with a view to mitigate the consequences of the relevant non-fulfilment of role by the Nodal Agency including giving time extension to TSP, having regard to all the circumstances.
- d. During the Consultation Period, both Parties shall, save as otherwise provided in this Agreement, continue to perform their respective obligations/ roles under this Agreement.

### **13.4 Termination due to Force Majeure**

13.4.1 In case the Parties could not reach an agreement pursuant to Articles 3.3.4 and 4.4.2 of this Agreement and the Force Majeure Event or its effects continue to be present, the Nodal Agency shall have the right to cause termination of the Agreement. In case of such termination, the Contract Performance Guarantee shall be returned to the TSP as per the provisions of Article 6.5.1.

13.4.2 In case of termination of this Agreement, the TSP shall provide to the Nodal Agency the full names and addresses of its Contractors as well as complete designs, design drawings, manufacturing drawings, material specifications and

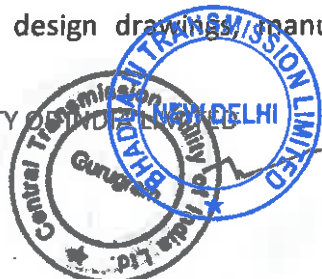

technical information, as required by the Nodal Agency within thirty (30) days of Termination Notice.

**13.5 Termination or amendment due to non-requirement of any Element or Project during construction**

13.5.1 In case any Element or Project, which is under construction, is no longer required due to any reason whatsoever, the Nodal Agency may issue a notice to this effect to the TSP.

13.5.2 Nodal agency may also issue notice to the TSP seeking their response to the proposed termination/ amendment (as the case may be) of the Agreement. The Nodal Agency shall issue copy of such notice to Lenders. In the notice, Nodal Agency shall also include an assessment of the physical progress made by TSP in the Element/ Project (as the case may be) that is no longer required.

13.5.3 The TSP shall neither carry out further investment nor carry out any work on the Element/ Project (as the case may be) that is no longer required after delivery of the notice.

13.5.4 After taking into account the comments of the TSP, the Nodal Agency may terminate the Agreement or amend it if both Parties agree to the amendment.

**13.6 Revocation of the Transmission License**

13.6.1 The Commission may, as per the provisions of the Electricity Act, 2003, revoke the Transmission License of the ISTS Licensee. Further, in such a case, the Agreement shall be deemed to have been terminated.

**13.7 Termination Payment**

13.7.1 If Agreement is terminated on account of Force Majeure Events, non-requirement of any Element or Project during Construction, Nodal Agency's non-fulfilment of Role & TSP's Event of Default, the TSP shall be entitled for Termination Payment equivalent to valuation of Project Assets. Upon payment, the Nodal Agency shall take over the Project Assets.

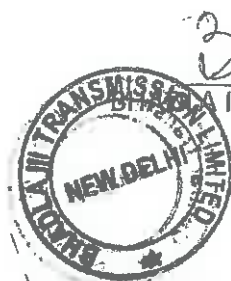
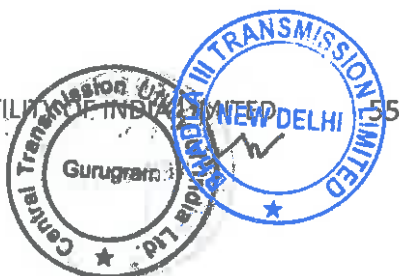

## ARTICLE: 14

### 14 LIABILITY AND INDEMNIFICATION

#### 14.1 Indemnity

14.1.1 The TSP shall indemnify, defend and hold the Nodal Agency harmless against:

- (a) any and all third party claims, actions, suits or proceedings against the Nodal Agency for any loss of or damage to property of such third party, or death or injury to such third party, arising out of a breach by the TSP of any of its obligations under this Agreement, except to the extent that any such claim, action, suit or proceeding has arisen due to a negligent act or omission, breach of this Agreement or non-fulfilment of statutory duty on the part of Nodal Agency; and
- (b) any and all losses, damages, costs and expenses including legal costs, fines, penalties and interest actually suffered or incurred by the Nodal Agency from third party claims arising by reason of:
  - i. a breach by the TSP of any of its obligations under this Agreement, (provided that this Article 14 shall not apply to such breaches by the TSP, for which specific remedies have been provided for under this Agreement) except to the extent that any such losses, damages, costs and expenses including legal costs, fines, penalties and interest (together to constitute "Indemnifiable Losses") has arisen due to a negligent act or omission, breach of this Agreement or non-fulfilment of statutory duty on the part of the Nodal Agency, or
  - ii. any of the representations and warranties of the TSP under this Agreement being found to be inaccurate or untrue.

14.1.2 The Nodal Agency shall, in accordance with the Regulations framed by CERC in this regard, indemnify, defend and hold the TSP harmless against:

- (a) any and all third party claims, actions, suits or proceedings against the TSP, for any loss of or damage to property of such third party, or death or injury to such third party, arising out of any material breach by the Nodal Agency of any of their roles under this Agreement, except to the extent that any such claim, action, suit or proceeding has arisen due to a negligent act or





omission, breach of this Agreement or breach of statutory duty on the part of the TSP, its Contractors, servants or agents; and

- (b) any and all losses, damages, costs and expenses including legal costs, fines, penalties and interest ('Indemnifiable Losses') actually suffered or incurred by the TSP from third party claims arising by reason of:
- i. any material breach by the Nodal Agency of any of its roles under this Agreement (provided that, this Article 14 shall not apply to such breaches by the Nodal Agency, for which specific remedies have been provided for under this Agreement), except to the extent that any such Indemnifiable Losses have arisen due to a negligent act or omission, breach of this Agreement or breach of statutory duty on the part of the TSP, its Contractors, servants or agents or
  - ii. any of the representations and warranties of the Nodal Agency under this Agreement being found to be inaccurate or untrue.

**14.2 Patent Indemnity:**

**14.2.1**

- (a) The TSP shall, subject to the Nodal Agency's compliance with Article 14.2.1 (b), indemnify and hold harmless the Nodal Agency and its employees and officers from and against any and all suits, actions or administrative proceedings, claims, demands, losses, damages, costs, and expenses of whatsoever nature, including attorney's fees and expenses, which the Nodal Agency may suffer as a result of any infringement or alleged infringement of any patent, utility model, registered design, trademark, copyright or other intellectual property right registered or otherwise existing at the date of the Agreement by reason of the setting up of the Project by the TSP.

Such indemnity shall not cover any use of the Project or any part thereof other than for the purpose indicated by or to be reasonably inferred from the Agreement, any infringement resulting from the misuse of the Project or any part thereof, or any products produced in association or combination with any other equipment, plant or materials not supplied by the TSP, pursuant to the Agreement.

- (b) If any proceedings are brought or any claim is made against the Nodal

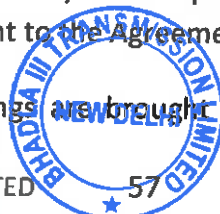

Agency arising out of the matters referred to in Article 14.2.1(a), the Nodal Agency shall promptly give the TSP a notice thereof, and the TSP shall at its own expense take necessary steps and attend such proceedings or claim and any negotiations for the settlement of any such proceedings or claim. The TSP shall promptly notify the Nodal Agency of all actions taken in such proceedings or claims.

- (c) If the TSP fails to notify the Nodal Agency within twenty-eight (28) days after receipt of such notice from the Nodal Agency under Article 14.2.1(b) above, that it intends to attend any such proceedings or claim, then the Nodal Agency shall be free to attend the same on their own behalf at the cost of the TSP. Unless the TSP has so failed to notify the Nodal Agency within the twenty eight (28) days period, the Nodal Agency shall make no admission that may be prejudicial to the defence of any such proceedings or claims.
- (d) The Nodal Agency shall, at the TSP's request, afford all available assistance to the TSP in attending to such proceedings or claim, and shall be reimbursed by the TSP for all reasonable expenses incurred in so doing.

14.2.2

- (a) The Nodal Agency, in accordance with the Regulations framed by CERC in this regard, subject to the TSP's compliance with Article 14.2.2(b) shall indemnify and hold harmless the TSP and its employees, officers from and against any and all suits, actions or administrative proceedings, claims, demands, losses, damages, costs and expenses of whatsoever nature, including attorney's fees and expenses, which the TSP may suffer as a result of any infringement or alleged infringement of any patent, utility model, registered design, trademark, copyright or other intellectual property right registered or otherwise existing at the date of the Agreement by reason of the setting up of the Project by the TSP.
- (b) If any proceedings are brought or any claim is made against the TSP arising out of the matters referred to in Article 14.2.2 (a) the TSP shall promptly give the Nodal Agency a notice thereof, and the Nodal Agency shall at its own expense take necessary steps and attend such proceedings or claim and any negotiations for the settlement of any such proceedings or claim. The Nodal Agency shall promptly notify the TSP of all actions taken in such proceedings or claims.



*310..*



*132*



- (c) If the Nodal Agency fails to notify the TSP within twenty-eight (28) days after receipt of such notice from the TSP under Article 14.2.2(b) above, that it intends to attend any such proceedings or claim, then the TSP shall be free to attend the same on its own behalf at the cost of the Nodal Agency. Unless the Nodal Agency has so failed to notify the TSP within the twenty (28) days period, the TSP shall make no admission that may be prejudicial to the defence of any such proceedings or claim.
- (d) The TSP shall, at the Nodal Agency request, afford all available assistance to the Nodal Agency in attending to such proceedings or claim, and shall be reimbursed by the Nodal Agency for all reasonable expenses incurred in so doing.

### 14.3 Monetary Limitation of liability

14.3.1 A Party ("Indemnifying Party") shall be liable to indemnify the other Party ("Indemnified Party") under this Article 14 for any indemnity claims made in a Contract Year only up to an amount of **Rs 4 Crore (Rupees Four Crore Only)**.

### 14.4 Procedure for claiming indemnity

14.4.1 Where the Indemnified Party is entitled to indemnification from the Indemnifying Party pursuant to Articles 14.1 or 14.2 the Indemnified Party shall promptly notify the Indemnifying Party of such claim, proceeding, action or suit referred to in Articles 14.1 or 14.2 in respect of which it is entitled to be indemnified. Such notice shall be given as soon as reasonably practicable after the Indemnified Party becomes aware of such claim, proceeding, action or suit. The Indemnifying Party shall be liable to settle the indemnification claim within thirty (30) days of receipt of the above notice.

Provided however that, if:

- i. the Parties choose to contest, defend or litigate such claim, action, suit or proceedings in accordance with Article 14.4.3 below; and
- ii. the claim amount is not required to be paid/deposited to such third party pending the resolution of the Dispute,

the Indemnifying Party shall become liable to pay the claim amount to the Indemnified Party or to the third party, as the case may be, promptly following the resolution of the Dispute, if such Dispute is not settled in favour of the Indemnified



210

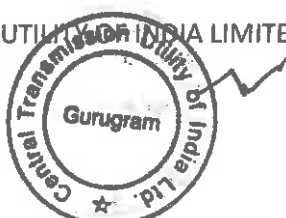

133



Party.

14.4.2 The Indemnified Party may contest, defend and litigate a claim, action, suit or proceeding for which it is entitled to be indemnified under Articles 14.1 or 14.2 and the Indemnifying Party shall reimburse to the Indemnified Party all reasonable costs and expenses incurred by the Indemnified Party. However, such Indemnified Party shall not settle or compromise such claim, action, suit or proceedings without first getting the consent of the Indemnifying Party, which consent shall not be unreasonably withheld or delayed.

14.4.3 An Indemnifying Party may, at its own expense, assume control of the defence of any proceedings brought against the Indemnified Party if it acknowledges its obligation to indemnify such Indemnified Party, gives such Indemnified Party prompt notice of its intention to assume control of the defence, and employs an independent legal counsel at its own cost that is reasonably satisfactory to the Indemnified Party.

#### 14.5 Limitation on Liability

14.5.1 Except as expressly provided in this Agreement, neither the TSP nor the Nodal Agency nor their respective officers, directors, agents, employees or Affiliates (including, officers, directors, agents or employees of such Affiliates), shall be liable or responsible to the other Party or its Affiliates including its officers, directors, agents, employees, successors, insurers or permitted assigns for incidental, indirect or consequential, punitive or exemplary damages, connected with or resulting from performance or non-performance of this Agreement, or anything done in connection herewith, including claims in the nature of lost revenues, income or profits (other than payments expressly required and properly due under this Agreement), any increased expense of, reduction in or loss of transmission capacity or equipment used therefore, irrespective of whether such claims are based upon breach of warranty, tort (including negligence, whether of the Nodal Agency, the TSP or others), strict liability, contract, breach of statutory duty, operation of law or otherwise.

14.5.2 The Nodal Agency shall have no recourse against any officer, director or shareholder of the TSP or any Affiliate of the TSP or any of its officers, directors or shareholders for such claims excluded under this Article. The TSP shall also have no recourse against any officer, director or shareholder of the Nodal Agency, or any Affiliate of the Nodal Agency or any of its officers, directors or shareholders for such claims excluded under this Article.

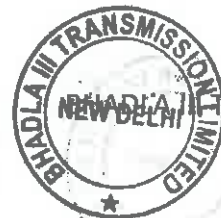

*Signature*

**14.6 Duty to Mitigate**

The party entitled to the benefit of an indemnity under this Article 14 shall take all reasonable measures to mitigate any loss or damage which has occurred. If the Party fails to take such measures, the other Party's liabilities shall be correspondingly reduced.

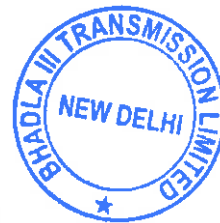

*210.*



*135*

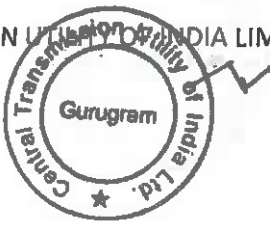



## ARTICLE: 15

### 15 ASSIGNMENTS AND CHARGES

#### 15.1 Assignments:

15.1.1 This Agreement shall be binding upon, and inure to the benefit of the Parties and their respective successors and permitted assigns. This Agreement shall not be assigned by any Party, except as provided in Article 15.3.

#### 15.2 Permitted Charges:

15.2.1 Neither Party shall create or permit to subsist any encumbrance over all or any of its rights and benefits under this Agreement.

15.2.2 However, the TSP may create any encumbrance over all or part of the receivables, or the Project Assets of the Project in favour of the Lenders or the Lenders' Representative on their behalf, as security for amounts payable under the Financing Agreements and any other amounts agreed by the Parties.

Provided that:

- i. the Lenders or the Lenders' Representative on their behalf shall have entered into the Financing Agreements and agreed in writing to the provisions of this Agreement; and
- ii. any encumbrance granted by the TSP in accordance with this Article 15.2.2 shall contain provisions pursuant to which the Lenders or the Lender's Representative on their behalf agrees unconditionally with the TSP to release from such encumbrances upon payment by the TSP to the Lenders of all amounts due under the Financing Agreements.

15.2.3 Article 15.2.1 does not apply to:

- a. liens arising by operation of law (or by an agreement evidencing the same) in the ordinary course of the TSP developing and operating the Project;
- b. pledges of goods, the related documents of title and / or other related documents, arising or created in the ordinary course of the TSP developing and operating the Project; or



*210..*



*136*



- c. security arising out of retention of title provisions in relation to goods acquired in the ordinary course of the TSP developing and operating the Project.

**15.3 Substitution Rights of the Lenders**

15.3.1 The TSP would need to operate and maintain the Project under the provisions of this Agreement and cannot assign the Transmission License or transfer the Project or part thereof to any person by sale, lease, exchange or otherwise, without the prior approval of the Nodal Agency.

15.3.2 However, in the case of default by the TSP in debt repayments or in the case of default by the TSP as per Article 13 of this Agreement during the debt repayments, the Commission may, on an application from the Lenders, assign the Transmission License to the nominee of the Lenders subject to the fulfilment of the qualification requirements and provisions of the Central Electricity Regulatory Commission (Procedure, terms and Conditions for grant of Transmission License and other related matters) Regulations, 2006 and as amended from time to time.

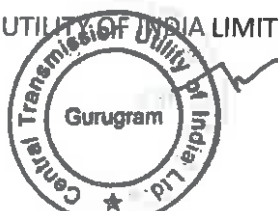

137



## ARTICLE: 16

### 16 GOVERNING LAW AND DISPUTE RESOLUTION

#### 16.1 Governing Law:

This Agreement shall be governed by and construed in accordance with the Laws of India. Any legal proceedings in respect of any matters, claims or disputes under this Agreement shall be under the jurisdiction of appropriate courts in Delhi.

#### 16.2 Amicable Settlement:

16.2.1 Either Party is entitled to raise any claim, dispute or difference of whatever nature arising under, out of or in connection with this Agreement, including its existence or validity or termination or whether during the execution of the Project or after its completion and whether prior to or after the abandonment of the Project or termination or breach of the Agreement by giving a written notice to the other Party, which shall contain:

- (i) a description of the Dispute;
- (ii) the grounds for such Dispute; and
- (iii) all written material in support of its claim.

16.2.2 The other Party shall, within thirty (30) days of issue of notice issued under Article 16.2.1, furnish:

- (i) counter-claim and defences, if any, regarding the Dispute; and
- (ii) all written material in support of its defences and counter-claim.

16.2.3 Within thirty (30) days of issue of notice by the Party pursuant to Article 16.2.1, if the other Party does not furnish any counter claim or defense under Article 16.2.2, or thirty (30) days from the date of furnishing counter claims or defence by the other Party, both the Parties to the Dispute shall meet to settle such Dispute amicably. If the Parties fail to resolve the Dispute amicably within thirty (30) days from the later of the dates mentioned in this Article 16.2.3, the Dispute shall be referred for dispute resolution in accordance with Article 16.3.



*Signature*

**16.3 Dispute Resolution:**

All Disputes shall be adjudicated by the Commission.

**16.4 Parties to Perform Obligations:**

Notwithstanding the existence of any Dispute and difference referred to the Commission as provided in Article 16.3 and save as the Commission may otherwise direct by a final or interim order, the Parties hereto shall continue to perform their respective obligations/ roles (which are not in dispute) under this Agreement.



**ARTICLE: 17**

**17 REPRESENTATION AND WARRANTIES**

**17.1 Representation and warranties of the Nodal Agency**

17.1.1 The Nodal Agency hereby represents and warrants to and agrees with the TSP as follows and acknowledges and confirms that the TSP is relying on such representations and warranties in connection with the transactions described in this Agreement:

- a. It has all requisite powers and authority to execute and consummate this Agreement;
- b. This Agreement is enforceable against the Nodal Agency in accordance with its terms;
- c. The consummation of the transactions contemplated by this Agreement on the part of Nodal Agency will not violate any provision of nor constitute a default under, nor give rise to a power to cancel any charter, mortgage, deed of trust or lien, lease, agreement, license, permit, evidence of indebtedness, restriction, or other contract to which the Nodal Agency is a Party or to which the Nodal Agency is bound, which violation, default or power has not been waived;

**17.2 Representation and Warranties of the TSP:**

17.2.1 The TSP hereby represents and warrants to and agrees with the Nodal Agency as follows and acknowledges and confirms that the Nodal Agency is relying on such representations and warranties in connection with the transactions described in this Agreement:

- a. It has all requisite powers and has been duly authorized to execute and consummate this Agreement;
- b. This Agreement is enforceable against it, in accordance with its terms;
- c. The consummation of the transactions contemplated by this Agreement on the part of the TSP will not violate any provision of nor constitute a default under, nor give rise to a power to cancel any charter, mortgage, deed of trust or lien, lease, agreement, license, permit, evidence of indebtedness, restriction, or other contract to which the TSP is a Party or to which the TSP is bound which violation, default or power has not been waived;

CENTRAL TRANSMISSION UTILITY OF INDIA LIMITED  
Central Transmission Utility of India Ltd. Gurugram

140

BHADLA TRANSMISSION LIMITED  
BHADLA NEW DELHI  
TRANSMISSION LIMITED  
NEW DELHI  
September 2023



Transmission Service Agreement

- d. The TSP is not insolvent and no insolvency proceedings have been instituted, nor threatened or pending by or against the TSP;
- e. There are no actions, suits, claims, proceedings or investigations pending or, to the best of the TSP's knowledge, threatened in writing against the TSP at law, in equity, or otherwise, and whether civil or criminal in nature, before or by, any court, commission, arbitrator or governmental agency or authority, and there are no outstanding judgments, decrees or orders of any such courts, commission, arbitrator or governmental agencies or authorities, which materially adversely affect its ability to execute the Project or to comply with its obligations under this Agreement.

17.2.2 The TSP makes all the representations and warranties above to be valid as on the Effective Date of this Agreement.



141



**ARTICLE: 18**

**18 INDEPENDENT ENGINEER**

**18.1 Appointment of Independent Engineer**

The Nodal Agency shall appoint an agency/ company as Independent Engineer as per framework provided in the Guidelines for Encouraging Competition in Development of Transmission Projects for selection of Independent Engineer.

**18.2 Roles and functions of Independent Engineer**

The role and functions of the Independent Engineer shall include the following:

- a. Progress Monitoring as required under this Agreement;
- b. Ensuring Quality as required under this Agreement;
- c. determining, as required under the Agreement, the costs of any works or services and/or their reasonableness during construction phase;
- d. determining, as required under the Agreement, the period or any extension thereof, for performing any duty or obligation during construction phase;
- e. determining, as required under the Agreement, the valuation of the Project Assets.
- f. Assisting the Parties in resolution of Disputes and
- g. Undertaking all other duties and functions in accordance with the Agreement.

**18.3 Remuneration of Independent Engineer**

The fee and charges of the Independent Engineer shall be paid by the Nodal Agency as per terms & conditions of appointment.

**18.4 Termination of appointment**

18.4.1 The Nodal Agency may, in its discretion, terminate the appointment of the Independent Engineer at any time, but only after appointment of another Independent Engineer.

18.4.2 If the TSP has reason to believe that the Independent Engineer is not discharging its duties and functions in a fair, efficient and diligent manner, it may make a written representation to the Nodal Agency and seek termination of the appointment of the Independent Engineer. Upon receipt of such representation,

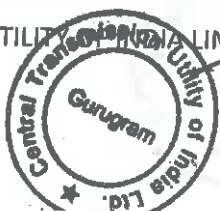

Transmission Service Agreement

the Nodal Agency shall hold a tripartite meeting with the TSP and Independent Engineer for an amicable resolution, and the decision of Nodal agency is final. In the event that the appointment of the Independent Engineer is terminated hereunder, the Nodal Agency shall appoint forthwith another Independent Engineer.

**18.5 Authorised signatories**

The Nodal Agency shall require the Independent Engineer to designate and notify to the Nodal Agency up to 2 (two) persons employed in its firm to sign for and on behalf of the Independent Engineer, and any communication or document required to be signed by the Independent Engineer shall be valid and effective only if signed by any of the designated persons; provided that the Independent Engineer may, by notice in writing, substitute any of the designated persons by any of its employees.



CENTRAL TRANSMISSION UTILITY OF INDIA LIMITED

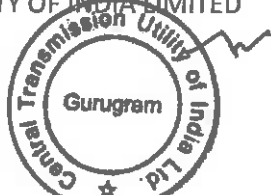

69



30.

BHADLA III TRANSMISSION LIMITED

| September 2023

**ARTICLE: 19**

**19 MISCELLANEOUS PROVISIONS**

**19.1 Equity Lock-in Commitment:**

19.1.1 The aggregate equity share holding of the Selected Bidder in the issued and paid up equity share capital of **Bhadla III Transmission Limited** shall not be less than Fifty one percent (51%) up to a period of one (1) year after COD of the Project.

Provided that, in case the Lead Member or Bidding Company is holding equity through Affiliate/s, Ultimate Parent Company or Parent Company, such restriction as specified above shall apply to such entities.

Provided further, that in case the Selected Bidder is a Bidding Consortium, the Lead Member shall continue to hold equity of at least twenty six percent (26%) upto a period of one (1) year after COD of the Project and any Member of such Bidding Consortium shall be allowed to divest its equity as long as the other remaining Members (which shall always include the Lead Member) hold the minimum equity specified above.

19.1.2 If equity is held by the Affiliates, Parent Company or Ultimate Parent Company of the Selected Bidder, then, subject to the second proviso to Article 19.1.1, such Affiliate, Parent Company or Ultimate Parent Company shall be eligible to transfer its shareholding in **Bhadla III Transmission Limited** to another Affiliate or to the Parent Company / Ultimate Parent Company of the Selected Bidder. If any such shareholding entity, qualifying as an Affiliate / Parent Company / Ultimate Parent Company, is likely to cease to meet the criteria to qualify as an Affiliate / Parent Company / Ultimate Parent Company, the shares held by such entity shall be transferred to another Affiliate / Parent Company / Ultimate Parent Company of the Selected Bidder.

19.1.3 Subject to Article 19.1.1, all transfer(s) of shareholding of **Bhadla III Transmission Limited** by any of the entities referred to in Article 19.1.1 and 19.1.2 above, shall be after prior written intimation to the Nodal Agency.

19.1.4 For computation of effective Equity holding, the Equity holding of the Selected Bidder or its Ultimate Parent Company in such Affiliate(s) or Parent Company and the equity holding of such Affiliate(s) or Ultimate Parent Company in **Bhadla III Transmission Limited** shall be computed in accordance with the example given below:

If the Parent Company or the Ultimate Parent Company of the Selected Bidder A



144

Transmission Service Agreement

directly holds thirty percent (30%) of the equity in **Bhadla III Transmission Limited**, then holding of Selected Bidder A in **Bhadla III Transmission Limited** shall be thirty percent (30%);

If Selected Bidder A holds thirty percent (30%) equity of the Affiliate and the Affiliate holds fifty percent (50%) equity in **Bhadla III Transmission Limited**, then, for the purposes of ascertaining the minimum equity/equity lock-in requirements specified above, the effective holding of Bidder A in **Bhadla III Transmission Limited** shall be fifteen percent (15%), (i.e., 30% x 50%)

19.1.5 The provisions as contained in this Article 19.1 shall override the terms of the consortium agreement submitted as part of the Bid.

19.1.6 The TSP shall be responsible to report to Nodal Agency, within thirty (30) days from the occurrence of any event that would result in any change in its equity holding structure from that which existed as on the date of signing of the Share Purchase Agreement. In such cases, the Nodal Agency would reserve the right to ascertain the equity holding structure and to call for all such required documents / information / clarifications as may be required.

**19.2 Commitment of maintaining Qualification Requirement**

19.2.1 The Selected Bidder will be required to continue to maintain compliance with the Qualification Requirements, as stipulated in RFP Document, till the COD of the Project. Where the Technically Evaluated Entity and/or the Financially Evaluated Entity is not the Bidding Company or a Member in a Bidding Consortium, as the case may be, the Bidding Company or Member shall continue to be an Affiliate of the Technically Evaluated Entity and/or Financially Evaluated Entity till the COD of the Project.

19.2.2 Failure to comply with the aforesaid provisions shall be dealt in the same manner as TSP's Event of Default as under Article 13 of this Agreement.

**19.3 Language:**

19.3.1 All agreements, correspondence and communications between the Parties relating to this Agreement and all other documentation to be prepared and supplied under the Agreement shall be written in English, and the Agreement shall be construed and interpreted in accordance with English language.

19.3.2 If any of the agreements, correspondence, communications or documents are prepared in any language other than English, the English translation of such agreements, correspondence, communications or documents shall prevail in



145



matters of interpretation.

#### 19.4 Affirmation

The TSP and the Nodal Agency, each affirm that:

1. neither it nor its respective directors, employees, or agents has paid or undertaken to pay or shall in the future pay any unlawful commission, bribe, pay-off or kick-back; and
2. it has not in any other manner paid any sums, whether in Indian currency or foreign currency and whether in India or abroad to the other Party to procure this Agreement, and the TSP and the Nodal Agency hereby undertake not to engage in any similar acts during the Term of Agreement.

#### 19.5 Severability

The invalidity or enforceability, for any reason, of any part of this Agreement shall not prejudice or affect the validity or enforceability of the remainder of this Agreement, unless the part held invalid or unenforceable is fundamental to this Agreement.

#### 19.6 Counterparts

This Agreement may be executed in one or more counterparts, each of which shall be deemed an original and all of which collectively shall be deemed one and the same Agreement.

#### 19.7 Breach of Obligations/ Roles

The Parties acknowledge that a breach of any of the obligations/ roles contained herein would result in injuries. The Parties further acknowledge that the amount of the liquidated damages or the method of calculating the liquidated damages specified in this Agreement is a genuine and reasonable pre-estimate of the damages that may be suffered by the non-defaulting Party in each case specified under this Agreement.

#### 19.8 Restriction of Shareholders / Owners Liability

19.8.1 Parties expressly agree and acknowledge that none of the shareholders of the Parties hereto shall be liable to the other Parties for any of the contractual obligations of the concerned Party under this Agreement.

19.8.2 Further, the financial liabilities of the shareholder(s) of each Party to this Agreement shall be restricted to the extent provided in the Indian Companies Act,

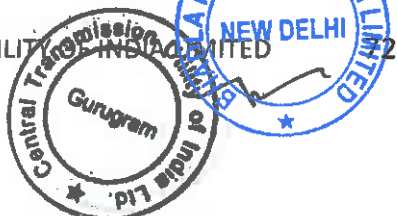

146



1956 / Companies Act, 2013 (as the case may be).

**19.9 Taxes and Duties:**

19.9.1 The TSP shall bear and promptly pay all statutory taxes, duties, levies and cess, assessed/levied on the TSP, its Contractors or their employees that are required to be paid by the TSP as per the Law in relation to the execution of the Project and for providing Transmission Service as per the terms of this Agreement.

19.9.2 The Nodal Agency shall be indemnified and held harmless by the TSP against any claims that may be made against the Nodal Agency in relation to the matters set out in Article 19.9.1.

19.9.3 The Nodal Agency shall not be liable for any payment of, taxes, duties, levies, cess whatsoever for discharging any obligation of the TSP by the Nodal Agency on behalf of TSP or its personnel, provided the TSP has consented in writing to the Nodal Agency for such work, for which consent shall not be unreasonably withheld.

**19.10 No Consequential or Indirect Losses**

The liability of the TSP shall be limited to that explicitly provided in this Agreement.

Provided that, notwithstanding anything contained in this Agreement, under no event shall the Nodal Agency or the TSP claim from one another any indirect or consequential losses or damages.

**19.11 Discretion:**

Except where this Agreement expressly requires a Party to act fairly or reasonably, a Party may exercise any discretion given to it under this Agreement in any way it deems fit.

**19.12 Confidentiality**

19.12.1 The Parties undertake to hold in confidence this Agreement and RFP Project Documents and not to disclose the terms and conditions of the transaction contemplated hereby to third parties, except:

- (a) to their professional advisors;
- (b) to their officers, contractors, employees, agents or representatives, financiers, who need to have access to such information for the proper performance of their activities; or
- (c) disclosures required under Law.



## Transmission Service Agreement

without the prior written consent of the other Parties.

Provided that, the TSP agrees and acknowledges that the Nodal Agency, may, at any time, disclose the terms and conditions of the Agreement and the RFP Project Documents to any person, to the extent stipulated under the Law and the Competitive Bidding Guidelines.

### 19.13 Order of priority in application:

Save as provided in Article 2.5, in case of inconsistencies between the terms and conditions stipulated in Transmission License issued by the Commission to the TSP, agreement(s) executed between the Parties, applicable Law including rules and regulations framed thereunder, the order of priority as between them shall be the order in which they are placed below:

- terms and conditions of Transmission License;
- applicable Law, rules and regulations framed thereunder;
- this Agreement;
- Agreement(s), if any, under Sharing Regulations.

### 19.14 Independent Entity:

19.14.1 The TSP shall be an independent entity performing its obligations pursuant to the Agreement.

19.14.2 Subject to the provisions of the Agreement, the TSP shall be solely responsible for the manner in which its obligations under this Agreement are to be performed. All employees and representatives of the TSP or Contractors engaged by the TSP in connection with the performance of the Agreement shall be under the complete control of the TSP and shall not be deemed to be employees, representatives, Contractors of the Nodal Agency and nothing contained in the Agreement or in any agreement or contract awarded by the TSP shall be construed to create any contractual relationship between any such employees, representatives or Contractors and the Nodal Agency.

### 19.15 Amendments:

19.15.1 This Agreement may only be amended or supplemented by a written agreement between the Parties.

CENTRAL TRANSMISSION UTILITIES LIMITED  
Gurugram  
BHADLA TRANSMISSION LIMITED  
NEW DELHI  
BHADLA TRANSMISSION LIMITED  
NEW DELHI  
September 2023

148

310..

**19.16 Waiver:**

- 19.16.1 No waiver by either Party of any default or breach by the other Party in the performance of any of the provisions of this Agreement shall be effective unless in writing duly executed by an authorised representative of such Party.
- 19.16.2 Neither the failure by either Party to insist on any occasion upon the performance of the terms, conditions and provisions of this Agreement nor time or other indulgence granted by one Party to the other. Parties shall act as a waiver of such breach or acceptance of any variation or the relinquishment of any such right or any other right under this Agreement, which shall remain in full force and effect.

**19.17 Relationship of the Parties:**

This Agreement shall not be interpreted or construed to create an association, joint venture, or partnership or agency or any such other relationship between the Parties or to impose any partnership obligation or liability upon either Party and neither Party shall have any right, power or authority to enter into any agreement or undertaking for, or act on behalf of, or to act as or be an agent or representative of, or to otherwise bind, the other Party.

**19.18 Entirety:**

- 19.18.1 This Agreement along with its sections, schedules and appendices is intended by the Parties as the final expression of their agreement and is intended also as a complete and exclusive statement of the terms of their agreement.
- 19.18.2 Except as provided in this Agreement, all prior written or oral understandings, offers or other communications of every kind pertaining to this Agreement or the provision of Transmission Service under this Agreement to the Nodal Agency by the TSP shall stand superseded and abrogated.

**19.19 Notices:**

- 19.19.1 All notices or other communications which are required to be given under this Agreement shall be in writing and in the English language
- 19.19.2 If to the TSP, all notices or communications must be delivered personally or by registered post or facsimile or any other mode duly acknowledged to the addressee below:

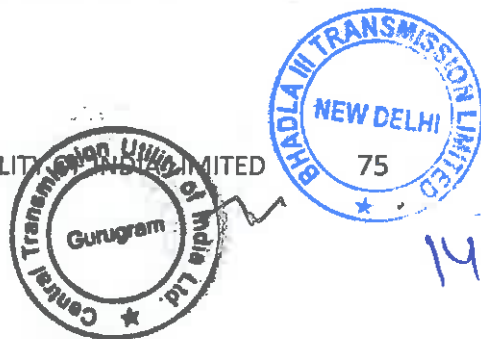

Transmission Service Agreement

Address :  
Attention :  
Email :  
Fax. No. :  
Telephone No. :

19.19.3 If to the Nodal Agency, all notices or communications must be delivered personally or by registered post or facsimile or any other mode duly acknowledged to the addresses below:

(i) **Central Transmission Utility of India Limited (Nodal Agency)**

Address : Plot No.2, Sector – 29, Gurugram, Haryana-122001, India  
Attention : Mr. Vikram Singh Bhal, ED  
Email : vsbhal@powergrid.in  
Fax. No. :  
Telephone No. : 9910378068

19.19.4 All notices or communications given by facsimile shall be confirmed by sending a copy of the same via post office in an envelope properly addressed to the appropriate Party for delivery by registered mail. All notices shall be deemed validly delivered upon receipt evidenced by an acknowledgement of the recipient, unless the Party delivering the notice can prove in case of delivery through the registered post that the recipient refused to acknowledge the receipt of the notice despite efforts of the postal authorities.

19.19.5 Any Party may by notice of at least fifteen (15) days to the other Party change the address and/or addresses to which such notices and communications to it are to be delivered or mailed.

**19.20 Fraudulent and Corrupt Practices**

19.20.1 The TSP and its respective officers, employees, agents and advisers shall observe the highest standard of ethics during the subsistence of this Agreement. Notwithstanding anything to the contrary contained in the Agreement, the Nodal Agency may terminate the Agreement without being liable in any manner whatsoever to the TSP, if it determines that the TSP has, directly or indirectly or through an agent, engaged in corrupt practice, fraudulent practice, coercive

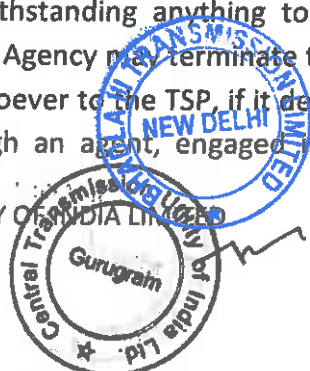



practice, undesirable practice or restrictive practice in the Bid process. In such an event, the Nodal Agency shall forfeit the Contract Performance Guarantee of the TSP, without prejudice to any other right or remedy that may be available to the Nodal Agency hereunder or subsistence otherwise.

19.20.2 Without prejudice to the rights of the Nodal Agency under Clause 19.20.1 hereinabove and the rights and remedies which the Nodal Agency may have under this Agreement, if a TSP is found by the Nodal Agency to have directly or indirectly or through an agent, engaged or indulged in any corrupt practice, fraudulent practice, coercive practice, undesirable practice or restrictive practice during the Bid process, or after the issue of Letter of Intent (hereinafter referred to as Lol) or after the execution of the agreement(s) required under Sharing Regulations, the Nodal Agency may terminate the Agreement without being liable in any manner whatsoever to the TSP. Further, the TSP & its Affiliates shall not be eligible to participate in any tender or RFP issued by any BPC for an indefinite period from the date such TSP is found by the Nodal Agency to have directly or indirectly or through an agent, engaged or indulged in any corrupt practice, fraudulent practice, coercive practice, undesirable practice or restrictive practices, as the case may be.

19.20.3 For the purposes of this Clause 19.20, the following terms shall have the meaning hereinafter respectively assigned to them:

(a) "corrupt practice" means (i) the offering, giving, receiving, or soliciting, directly or indirectly, of anything of value to influence the actions of any person connected with the Bid process (for avoidance of doubt, offering of employment to or employing or engaging in any manner whatsoever, directly or indirectly, any official of the BPC who is or has been associated or dealt in any manner, directly or indirectly with the Bid process or the Lol or has dealt with matters concerning the RFP Project Documents or arising there from, before or after the execution thereof, at any time prior to the expiry of one year from the date such official resigns or retires from or otherwise ceases to be in the service of the BPC, shall be deemed to constitute influencing the actions of a person connected with the Bid Process); or (ii) engaging in any manner whatsoever, whether during the Bid Process or after the issue of the Lol or after the execution of the RFP Project Documents, as the case may be, any person in respect of any matter relating to the Project or the Lol or the RFP Project Documents, who at any time has been or is a legal, financial or technical adviser of the BPC in relation to any matter concerning the Project;



Transmission Service Agreement

(b) "fraudulent practice" means a misrepresentation or omission of facts or suppression of facts or disclosure of incomplete facts, in order to influence the Bid process;

(c) "coercive practice" means impairing or harming, or threatening to impair or harm, directly or indirectly, any person or property to influence any person's participation or action in the Bid process;

(d) "undesirable practice" means (i) establishing contact with any person connected with or employed or engaged by the BPC with the objective of canvassing, lobbying or in any manner influencing or attempting to influence the Bid process; or (ii) having a Conflict of Interest; and

(e) "restrictive practice" means forming a cartel or arriving at any understanding or arrangement among Bidders with the objective of restricting or manipulating a full and fair competition in the Bid process;

**19.21 Compliance with Law:**

Despite anything contained in this Agreement but without prejudice to Article 12, if any provision of this Agreement shall be in deviation or inconsistent with or repugnant to the provisions contained in the Electricity Act, 2003, or any rules and regulations made there under, such provision shall be deemed to be amended to the extent required to bring it into compliance with the aforesaid relevant provisions as amended from time to time.

**IN WITNESS WHEREOF, THE PARTIES HAVE CAUSED THIS AGREEMENT TO BE EXECUTED BY THEIR DULY AUTHORISED REPRESENTATIVES AS OF THE DATE AND PLACE SET FORTH ABOVE.**

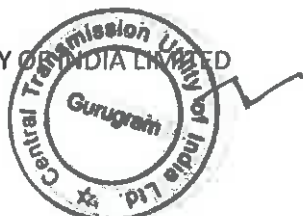

78

152



September 2023

Transmission Service Agreement

1. For and on behalf of TSP

*[Signature]*  
.....

[Signature, Name, Designation and Address]

2. For and on behalf of Central Transmission Utility of India Limited (Nodal Agency)

*[Signature]*  
.....

[Signature, Name, Designation and Address]

**WITNESSES:**

1. For and on behalf of

: BPC

*[Signature]*  
.....

[Signature]

*[Name]*  
.....

[Insert, Name, Designation and Address of the Witness]

2. For and on behalf of

: Nodal Agency

*[Signature]*  
.....

[Signature]

*[Name]*  
.....

[Insert Name, Designation and Address of the Witness]



# SCHEDULES



CENTRAL TRANSMISSION UTILITY OF INDIA LIMITED



80

154



BHADLA III TRANSMISSION LIMITED

| September 2023

2 /

**Schedule: 1**

**Project Description and Scope of Project**

**a. Description of the Transmission Scheme**

In order to integrate and evacuate power from additional potential (20GW) in various renewable energy zones in Rajasthan [Fatehgarh: 9.1GW, Bhadla: 8GW, Ramgarh: 2.9GW] as indicated by SECI, various transmission alternatives were evolved and deliberated in 3rd NRPC-TP meeting held on 19.02.2021. Based on deliberations in above meeting, hybrid (EHVAC & HVDC) transmission system was agreed for evacuation of power from additional 20GW RE Potential in Rajasthan (Phase-III).

As part of Phase-III system, Bhadla-3 PS is to be established which shall be integrated with Fatehgarh-II PS and Sikar-II S/s. Further, another new Ramgarh PS shall also be connected with Bhadla-3 for evacuation of power from Ramgarh Complex. Accordingly, the subject scheme "Transmission system for evacuation of power from REZ in Rajasthan (20 GW) under Phase III –Part B1" has been planned to establish connectivity as well as enable the evacuation of RE power from Bhadla-3 PS and Ramgarh PS (beyond Bhadla-3) under phase III.

The subject transmission scheme involves establishment of 765/400/220 kV pooling station at Bhadla-3, implementation of Fatehgarh-2 – Bhadla-3 400 kV D/c line (Quad Moose) and Bhadla-3 – Sikar-2 765kV D/c line which shall facilitate evacuation of RE power from Bhadla & Ramgarh complexes for onward dispersal of power to various beneficiaries.

Above transmission system for evacuation of power from REZ in Rajasthan (20 GW) under Phase III was also agreed in 49th Northern Region Power Committee (NRPC) meeting held on 27.09.2021 & 5th National Committee on Transmission (NCT) held on 25.08.2021 and 02.09.2021. Subsequently, Ministry of Power, Government of India, vide its Gazette Notification CG-DL-E-08122021-231686 (No. 4661) dated 06.12.2021 declared establishment of Bhadla-3 PS along with its interconnections through tariff based competitive bidding process route as part of "Transmission system for evacuation of power from REZ in Rajasthan (20 GW) under Phase III".

Subsequently, in a meeting held on 01.05.2023 under the chairmanship of Secretary, MoP, to review the progress of under construction/ under bidding/ planned Transmission Projects for evacuation of Renewable Energy (RE) projects, it was directed that the process of delinking of 400 kV Fatehgarh-II- Bhadla-III D/c line from Phase-III Part-B1 may be carried out at the earliest and a separate

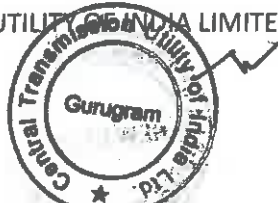

155

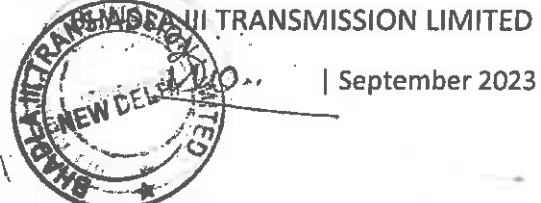



Transmission Service Agreement

package may be formed comprising 400 kV Fatehgarh-II- Bhadla III D/c line. Accordingly, in line with above directions, Fatehgarh-2 PS – Bhadla-3 PS 400kV D/c line (Quad Moose) was deleted from the package of "Transmission System for Evacuation of Power From REZ in Rajasthan (20 GW) Under Phase III –Part-B1" in 14th NCT meeting held on 09.06.2023.



*M.O.*



156

Transmission Service Agreement

b. Detailed Scope of Work

Transmission system for evacuation of power from REZ in Rajasthan (20 GW) under phase III –Part-B1		
S. No.	Name of Transmission Element	Scheduled COD in months from Effective Date
1.	<p>Establishment of 2x1500 MVA 765/400kV &amp; 3x500 MVA 400/220 kV pooling station at Bhadla-3 along with 2x330 MVA (765kV) Bus Reactor &amp; 2x125 MVA (420kV) Bus Reactor</p> <ul style="list-style-type: none"> <li>• 765/400kV 1500 MVA ICTs: 2 nos. (7x500 MVA including one spare unit)</li> <li>• 765kV ICT bays - 2 nos.</li> <li>• 400/220 kV, 500 MVA ICT – 3 nos.</li> <li>• 765kV line bays -2 nos.</li> <li>• 400 kV ICT bays – 5 nos.</li> <li>• 220 kV ICT bays - 3 nos.</li> <li>• 220 kV line bays: 5 nos.</li> <li>• 330 MVA Bus Reactor-2 nos. (7x110 MVA, including one spare unit)</li> <li>• 765kV reactor bay- 2 nos.</li> <li>• 125 MVA, 420kV bus reactor - 2 nos.</li> <li>• 420 kV reactor bay - 2 nos.</li> </ul> <p><b>Future provisions: Space for</b></p> <ul style="list-style-type: none"> <li>• 765/400kV ICTs along with bays: 2 nos.</li> <li>• 765kV line bay along with switchable line reactor: 6 nos.</li> <li>• 765kV line bay: 4 nos.</li> <li>• 765kV Bus Reactor along with bays: 2 nos.</li> <li>• 400/220 kV ICTs along with bays: 10 nos.</li> <li>• 400 kV line bays: 8 nos.</li> <li>• 400 kV line bays along with switchable line reactor: 8 Nos.</li> <li>• 400kV Bus Reactor along with bays: 2 nos.</li> <li>• 400kV Sectionalization bays 2 sets</li> </ul>	18 months

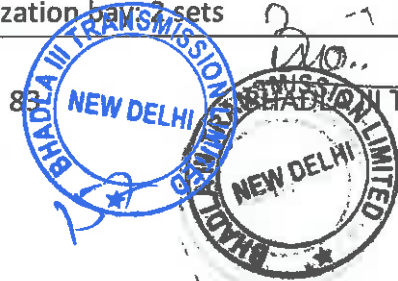
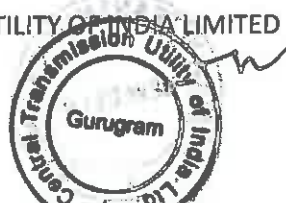

Transmission Service Agreement

Transmission system for evacuation of power from REZ in Rajasthan (20 GW) under phase III –Part-B1		
S. No.	Name of Transmission Element	Scheduled COD in months from Effective Date
	<ul style="list-style-type: none"> <li>• 220 kV line bays: 12 nos.</li> <li>• 220kV sectionalization bay: 2 sets</li> </ul>	
2.	Bhadla-3 PS – Sikar-II S/s 765 kV D/c line along with 330 MVAR Switchable line reactor for each circuit at each end of Bhadla-3 PS – Sikar-II S/s 765 kV D/c line <ul style="list-style-type: none"> <li>• Switching equipment for 765 kV 330 MVAR switchable line reactor – 4 nos.</li> <li>• 765 kV, 330 MVAR Switchable line reactor- 4 nos.</li> </ul>	
3.	765kV line bays at Sikar-II <ul style="list-style-type: none"> <li>• 765 kV line bays – 2 nos.</li> </ul>	

Note:

- i. Provision of suitable sectionalization shall be kept at Bhadla-3 at 400 kV & 220 kV level to limit short circuit level.
- ii. Developer of Sikar-II S/s to provide space for 2 nos. of 765 kV line bays at Sikar-II S/s along with space for switchable line reactors.
- iii. Space provision for future 2 nos. 220kV Bus Coupler bay and 2 nos. Transfer Bus Coupler Bay shall be kept for bus switching scheme requirement.



*Signature*

**SPECIFIC TECHNICAL REQUIREMENTS FOR TRANSMISSION LINE**

- A.1.0 The design, routing and construction of transmission lines shall be in accordance with Chapter V, Part A of CEA (Technical Standards for Construction of Electrical Plants and Electric Lines) Regulations 2010, as amended from time to time.
- A.2.0 Selection of tower type shall be made as per CEA Regulations, however in case lattice type towers are used, the following shall also be applicable:
  - A.2.1 Steel section of grade E 250 and/or grade E 350 as per IS 2062, only are permitted for use in towers, extensions, gantry structures and stub setting templates. For towers in snowbound areas, steel sections shall conform to Grade-C of IS-2062.
  - A.2.2 Towers shall be designed as per IS-802:2015, however the drag coefficient of the tower shall be as follows: -

Solidity Ratio	Drag Coefficient
Upto 0.05	3.6
0.1	3.4
0.2	2.9
0.3	2.5
0.4	2.2
0.5 and above	2.0

- A.3.0 Transmission Service Provider (TSP) shall adopt any additional loading/design criteria for ensuring reliability of the line, if so desired and /or deemed necessary.
- A.4.0 Transmission line shall be designed considering wind zones as specified in wind map given in National Building Code 2016, Vol.1. The developer shall also make his own assessment of local wind conditions and frequent occurrences of high intensity winds (HIW) due to thunderstorms, dust-storms, downburst etc. along the line route and wherever required, higher wind zone than that given in wind map shall be considered for tower design for ensuring reliability of line. Further, for transmission line sections passing within a distance of 50 km from the boundary of two wind zones, higher of the two wind zones shall be considered for design of towers located in such sections.

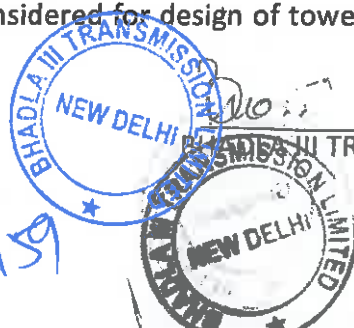
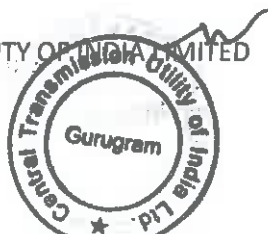

**Transmission Service Agreement**

- A.5.0 Towers for 400 kV line with triple and quadruple circuits or with more than two sub-conductors per phase and all towers of 765 kV lines shall be designed for reliability level 2. However, special towers and tall river crossing towers shall be designed with reliability level 3.
- A.6.0
- A) For power line crossing of 400kV or above voltage level (if crossed over the existing line), large angle & dead end towers (i.e. D/DD/QD) shall be used on either side of power line crossing.
- B) For power line crossing of 132kV and 220kV (or 230kV) voltage level, angle towers (B/C/D/DB/DC/DD/QB/QC/QD) shall be used on either side of power line crossing depending upon the merit of the prevailing site condition and line deviation requirement.
- C) For power line crossing of 66kV and below voltage level, suspension/tension towers shall be provided on either side of power line crossing depending upon the merit of the prevailing site condition and line deviation requirement.
- D) For crossing of railways, national highways and state highways, the rule/Regulations of appropriate authorities shall be followed.
- A.7.0 The relevant conductor configuration shall be as follows:-  
Type of conductor: ACSR / AAAC / AL59

**Basic parameters:**

Transmission line	ACSR Conductor specified	Equivalent AAAC conductor based on 53.5% conductivity of Al Alloy	Equivalent minimum size of AL59 conductor based on 59% conductivity of AL Alloy*	Sub-conductor Spacing
765kV D/C (Hexa Zebra) transmission lines	Zebra: Stranding 54/3.18 mm-Al + 7/3.18 mm-Steel, 28.62 mm	Stranding details: 61/3.19mm, 28.71 mm diameter; 487.5 sq.mm	Stranding details: 61/3.08mm, 27.72 mm diameter; 454 sq.mm	

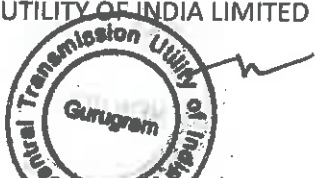



Transmission Service Agreement

Transmission line	ACSR Conductor specified	Equivalent AAAC conductor based on 53.5% conductivity of Al Alloy	Equivalent minimum size of AL59 conductor based on 59% conductivity of AL Alloy*	Sub-conductor Spacing
	diameter; 428 sq.mm Aluminium area,  Maximum DC Resistance at 20°C (Ω/km): 0.06868  Minimum UTS: 130.32 kN	Aluminium alloy area  Maximum DC Resistance at 20°C (Ω/km): 0.06815  Minimum UTS: 135.6 kN	Aluminium alloy area  Maximum DC Resistance at 20°C (Ω/km): 0.0653  Minimum UTS: 108 kN	457 mm
400kV D/C (Quad Moose) transmission lines	Moose: Stranding 54/3.53mm-Al + 7/3.53 mm-Steel, 31.77 mm diameter  528.5 sq. mm, Aluminium area,  Maximum DC Resistance at 20°C (Ω/km): 0.05552 Minimum UTS: 161.20 kN	Stranding details: 61/3.55mm 31.95mm diameter;  604 sq. mm Aluminium alloy area  Maximum DC Resistance at 20°C (Ω/km): 0.05506 Minimum UTS: 159.80 kN	Stranding details: 61/3.31 mm 29.79 mm diameter;  525 sq. mm Aluminium alloy area  Maximum DC Resistance at 20°C (Ω/km): 0.0566 Minimum UTS: 124.70 kN	457 mm



*Signature*



161

Transmission Service Agreement

**Note:**

1. \* To Select any size above the minimum, the sizes mentioned in the relevant Indian standard i.e IS-398(part-6) should be followed.
2. The transmission lines shall have to be designed for a maximum operating conductor temperature of 85 deg C.

A.8.0 The required phase to phase spacing and horizontal spacing for 765kV and 400kV line shall be governed by the tower design as well as minimum live metal clearances for 765kV and 400kV voltage level under different insulator swing angles. However, the phase to phase spacing for 765kV and 400kV lines shall not be less than 15m and 8m respectively.

A.9.0 All electrical clearances including minimum live metal clearance, ground clearance and minimum mid span separation between earth wire and conductor shall be as per Central Electricity Authority (Measures Relating to Safety & Electric Supply) Regulations as amended from time to time and IS: 5613. Since these clearances for 765kV are not included in CEA Regulation/ Indian Standard, following values shall be considered:

**Minimum live metal clearances for 765 kV line:**

- a) (i) Under stationary conditions:  
From tower body: For 765 kV D/C: 6.1 m  
For 765 kV S/C: 5.6 m

(ii) Under Swing conditions

Wind Pressure Condition	Minimum Electrical Clearance
a) Swing angle (25°)	4.4 mtrs
b) Swing angle (55°)	1.3 mtrs

- b) Minimum ground clearance: 18 m  
c) Minimum mid span separation between earthwire and conductor: 9.0 m

**Minimum live metal clearances for 400 kV line:**

- a) (i) Under stationary conditions:  
From tower body: 3.05m

(ii) Under Swing conditions

Wind Pressure Condition	Minimum Electrical Clearance
a) Swing angle (22°)	3.05 mtrs
b) Swing angle (44°)	1.86 mtrs



Transmission Service Agreement

- b) Minimum ground clearance: 8.84 m  
c) Minimum mid span separation between earthwire and conductor: 9.0 m
- A.10.0 Shielding angle shall not exceed 10deg for 765kV D/c and 20 deg for 400kV D/c Line transmission line.
- A.11.0 The Fault current for design of line shall be 50kA for 1 sec for 765kV and 63kA for 1 sec for 400kV.
- A.12.0 In case of 765kV & 400kV voltage class lines, at least one out of two earth wires shall be OPGW and second earth wire, if not OPGW, shall be either of galvanized standard steel (GSS) or AACSR or any other suitable conductor type depending upon span length and other technical consideration.
- A.13.0 Each tower shall be earthed such that tower footing impedance does not exceed 10 ohms. Pipe type or Counterpoise type earthing shall be provided in accordance with relevant IS. Additional earthing shall be provided on every 7 to 8 kms distance at tension tower for direct earthing of both shield wires. If site condition demands, multiple earthing or use of earthing enhancement compound shall be used.
- A.14.0 Pile type foundation shall be used for towers located in river or creek bed or on bank of river having scourable strata or in areas where river flow or change in river course is anticipated, based on detailed soil investigation and previous years' maximum flood discharge of the river, maximum velocity of water, highest flood level, scour depth & anticipated change in course of river based on river morphology data of at least past 20 years to ensure availability and reliability of the transmission line.
- A.15.0 Transmission line route shall be finalized, in consultation with appropriate authorities so as to avoid the habitant zones of endangered species and other protected species. Bird diverters, wherever required, shall be provided on the line.
- A.16.0 The raised chimney foundation is to be provided in areas prone to flooding/water stagnation like paddy field /agricultural field & undulated areas to avoid direct contact of water with steel part of tower. The top of the chimney of foundation should be at least above HFL (High Flood Level) or the historical water stagnation/ logging level (based on locally available data) or above High Tide Level or 500 mm above Natural Ground level (whichever is higher).

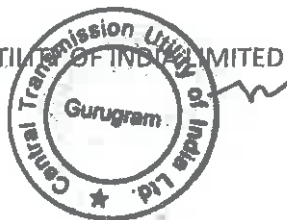

Transmission Service Agreement

A.17.0 For the transmission lines upto 400 kV level which are passing through wildlife/ eco sensitive zones, the towers located in such sections shall be designed for Multicircuit (4 circuits) configuration of same voltage level considering reliability level of at least two (2),. The top two circuits of these multi-circuit towers shall be used for stringing of the transmission line of scope & the bottom two circuits shall be made available for stringing of any future transmission line passing through the same wildlife/ eco sensitive zone and owned by any transmission service providers/ State transmission utilities/Central transmission utilities, whatever the case may be. Further, the configuration and coordinates of such transmission towers shall be submitted to CEA, CTU & BPC by the transmission service provider.



CENTRAL TRANSMISSION UTILITY LIMITED



90

164



*Signature*

BHADLA III TRANSMISSION LIMITED

| September 2023

**SPECIFIC TECHNICAL REQUIREMENTS FOR SUBSTATION**

The proposed 765/400/220kV Pooling Station at **Bhadla-3** shall be conventional AIS type generally conforming to the requirements of CEA (Technical Standards for Construction of Electrical Plants and Electric Lines) Regulations 2010, as amended from time to time.

Extension of 765kV existing **Sikar-II** and 400 kV existing **Fatehgarh-2** substation shall be (AIS) type generally conforming to the requirements of CEA (Technical Standards for Construction of Electrical Plants and Electric Lines) Regulations 2010, as amended from time to time.

**B.1.0 Salient features of Substation Equipment and Facilities**

The design and specification of substation equipment are to be governed by the following factors:

**B.1.1 Insulation Coordination**

The system design parameters for substations/switchyards shall be as given below:

Sl No	Description of parameters	765/400/220 kV Bhadla-3			Extn. of Sikar-II S/s	Extn. of Fatehgarh-2 S/s
		765 kV System	400 kV System	220 kV System	765 kV System	400 kV System
1.	System operating voltage	765kV	400kV	220kV	765kV	400kV
2.	Maximum voltage of the system (rms)	800kV	420kV	245kV	800kV	420kV
3.	Rated frequency	50Hz	50Hz	50Hz	50Hz	50Hz
4.	No. of phase	3	3	3	3	3
5.	Rated Insulation levels					
i)	Lightning Impulse withstand voltage for (1.2/50 micro sec.)					
	- For Equipment other than Transformer and Reactors	2100kVp	1425kVp	1050kVp	2100kVp	1425kVp
	- for Insulator String	2100kVp	1550kVp	1050kVp	2100kVp	1550kVp

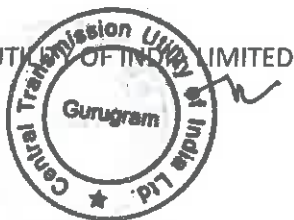



Transmission Service Agreement

Sl No	Description of parameters	765/400/220 kV Bhadla-3			Extn. of Sikar-II S/s	Extn. of Fatehgarh-2 S/s
		765 kV System	400 kV System	220 kV System	765 kV System	400 kV System
ii)	Switching impulse withstand voltage (250/2500 micro sec.) dry and wet	1550kVp	1050kVp	-	1550kVp	1050kVp
iii)	One-minute power frequency dry withstand voltage (rms)	830kV	630kV	-	830kV	630kV
iv)	One minute power frequency dry and wet withstand voltage (rms)	-	-	460kV	-	-
6.	Corona extinction voltage	508 kV	320kV	-	508 kV	320kV
7.	Max. radio interference voltage for frequency between 0.5 MHz and 2 MHz	2500 micro-volts at 508 kV rms	1000 micro-volts at 266kV rms	1000 micro-volts at 156kV rms	2500 micro-volts at 508 kV rms	1000 micro-volts at 266kV rms
8.	Minimum creepage distance for insulator string/ longrod insulators/ outdoor bushings	24800 mm (31mm/ kV)	13020 mm (31mm/ kV)	7595 mm (31mm/ kV)	24800 mm (31mm/ kV)	13020 mm (31mm/ kV)
9.	Minimum creepage distance for switchyard equipment	20000 mm (25mm/ kV)	10500 mm (25mm/ kV)	6125 mm (25mm/ kV)	20000 mm (25mm/ kV)	10500 mm (25mm/ kV)
10.	Max. fault current	50 kA	63kA	50kA	50 kA	50kA
11.	Duration of fault	1 sec	1 Sec	1 Sec	1 sec	1 Sec



*200*

**B.1.2 Switching Scheme**

The switching schemes, as mentioned below, shall be adopted at various voltage levels of substation/switchyard:

Substation	765kV side	400kV side	220kV side
765/400/220kV Bhadla-3 PS	One & half breaker (AIS)	One & half breaker (AIS)	Double Main & Transfer (AIS)
765/400/220kV Sikar-II PS	One & half breaker (AIS)	One & half breaker (AIS)	--
400/220kV Fatehgarh-2 S/S	One & half breaker (AIS)	One & half breaker (AIS)	--

**Notes: -**

- i) At 765kV & 400kV voltage level, each circuit of a double circuit transmission line shall be terminated in different diameters.
- ii) Two transformers of same HV rating shall not be connected in the same diameter and similarly, two bus reactors of same HV rating shall also not be connected in the same diameter.
- iii) Bus coupler bay and bus transfer bay in each section shall be provided as a function requirement for Double Main and Transfer Bus Switching Scheme.
- iv) Bay configuration at 765kV Bhadla-3 s/s shall be such that one feeder in a diameter shall be terminated to a Line and other shall be terminated to ICTs /Bus Reactors. Accordingly, 02 nos. complete diameter and 02 nos. half diameter (consisting of Main and associated Tie bays) with a provision of 02 nos. future bays (for terminating 765kV Ramgarh -Bhadla-3 D/C line) in the same diameter shall be under present scope.
- v) Bay configuration at 400kV Bhadla-3 s/s shall be such that one feeder in a diameter shall be terminated to ICT and other shall be terminated to Line/Bus Reactor. Accordingly, 02 nos. complete diameter (the bay configuration shall be ICT-Tie-Bus Reactor) and 03 nos. half diameter (consisting of Main and associated Tie bay) with a provision of 03 no. future line bay in the other half (the bay configuration shall be ICT-Tie- future line with space for switchable Reactor) shall be under the present scope.

**(01 no. future line bay as mentioned above shall be utilized for termination of one circuit of 400kV Bhadla-3 to Fatehgarh-3 D/C line which is under a separate scheme. Balance 02 nos. line bays are identified for future line bay which has been created due to deletion of Fatehgarh-2 to Bhadla -3 400kV D/C line.)**

TSP shall share Single Line Diagram to CEA/CTUIL during finalization of bay to developer of 400kV Bhadla-3 to Fatehgarh-3 D/C line.

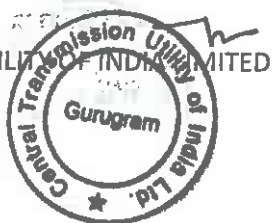

**B.2.0 Substation Equipment and facilities (Voltage level as applicable):**

The switchgear shall be designed and specified to withstand operating conditions and duty requirements. All equipment shall be designed considering the following capacity.

Sl. No	Description of bay	765/400kV Bhadla-3			Sikar-II	Fatehgarh-2
		765kV	400kV	220kV	765kV	400kV
1.	Bus Bar	4000A	4000A	4000A	4000A	4000A
2.	Line bay	3150 A	3150 A	1600A	3150 A	3150 A
3.	ICT bay	3150 A	3150 A	1600A	3150 A	3150 A
4.	Bus Reactor bay	3150 A	3150 A	-	3150A	3150 A
5.	Switched Line Reactor Bay	3150 A	3150 A	-	3150 A	3150 A
6.	Bus Coupler bay	-	-	3150A	-	-
7.	Transfer Bus coupler bay	-	-	1600A	-	-

**B.2.1  $(765/\sqrt{3})/(400/\sqrt{3})/33$  kV, Single Phase Autotransformer**

500 MVA  $(765/\sqrt{3})/(400/\sqrt{3})/33$  kV ,1-phase Transformer (including arrangement for 3-phase bank formation of 1500 MVA) shall conform to CEA's "Standard Specifications and Technical Parameters for Transformers and Reactors (66 kV and above)" available on CEA website.

Spare 1-phase Transformer unit shall be placed and connected in such a way that in case of fault in any unit of any of the transformer banks (including for future transformer banks) can be replaced by spare unit without physically moving it.

**B.2.2 400/220 kV Autotransformer**

500 MVA 400/220kV, 3-phase Transformer shall conform to CEA's "Standard Specifications and Technical Parameters for Transformers and Reactors (66 kV and above)" available on CEA website.

**B.2.3  $(765/\sqrt{3})$  kV, Single Phase Shunt Reactor**

110 MVAR,  $765/\sqrt{3}$  kV, 1-Phase Reactor (including arrangement for 3-phase bank formation of 330 MVAR) shall conform to CEA's "Standard Specifications and Technical Parameters for Transformers and Reactors (66 kV and above)" available on CEA website.

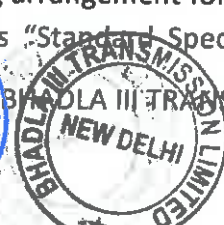

Transmission Service Agreement

Technical Parameters for Transformers and Reactors (66 kV and above)" as amended up to date available on CEA website.

Spare 1-phase Shunt Reactor unit shall be placed and connected in such a way that the spare unit can be utilized for all the bus and line reactor banks (including for future reactor banks) without its physical movement.

**B.2.4 420kV, 3-phase, Shunt Reactor**

125 MVAR, 420kV, 3-Phase Reactor shall conform to CEA's "Standard Specifications and Technical Parameters for Transformers and Reactors (66 kV and above)" available on CEA website.

**Neutral Grounding Reactor (NGR) and Surge Arrester for 765 kV & 420 kV Line Reactors (as applicable)**

The neutral of the line reactors (wherever provided) shall be grounded through 450 ohm Neutral Grounding Reactors (NGR) to facilitate single phase auto-reclosure, provided that the NGR shall be provided with bypass arrangement through a breaker so that the line reactor can be used as Bus reactor as and when required. The neutral of bus reactor shall be solidly grounded.

NGR shall be oil filled or dry type air core for outdoor application. NGR shall conform to CEA's "Standard specifications and technical parameters of transformers and reactors (66kV and above)". Technical parameters of NGR shall be as specified in Annexure-A of above mentioned document.

The surge arresters (rated voltage of arrester in co-ordination with ohmic value of NGR shall be decided by the TSP) shall be provided & physically located between the neutral of shunt reactor (brought out at 145kV class bushing) and neutral grounding reactor. The surge arresters shall be of heavy duty station class gapless Metal oxide (ZnO) type conforming in general to IEC-60099-4. Arresters shall be hermetically sealed units, of self-supporting construction, suitable for mounting on structures.

**B.2.5 765kV, 400kV & 220kV AIS Substation equipment (as applicable)**

**B.2.5.1 Circuit Breakers (AIS)**



3/10..

The circuit breakers and accessories shall conform to IEC: 62271-100, IEC: 62271-1 and shall be of SF6 Type. The circuit breakers shall be of class C2-M2 (as per IEC) with regard to restrike probability during capacitive current breaking and mechanical endurance. The rated break time shall not exceed 40ms for 765kV & 400kV circuit breakers and 60ms for 220kV circuit breakers. 765kV, 400kV & 220kV Circuit breakers shall be provided with single phase and three phase auto reclosing. The Circuit breakers controlling 765kV lines shall be provided either with pre-insertion closing resistor of about 450 ohms maximum with 9 ms minimum insertion time or with Controlled Switching Device. The Circuit breakers controlling 400kV lines shall be provided with pre-insertion closing resistor of about 400 ohms maximum with 8 ms minimum insertion time or Controlled Switching Device (CSD) for lines longer than 200 km. The short line fault capacity shall be same as the rated capacity and this is proposed to be achieved without use of opening resistors. The controlled switching device shall be provided in Circuit breakers of switchable line reactor and in Main & Tie circuit breakers of line with non-switchable line reactors and Bus reactors and 765/400kV Transformers.

#### B.2.5.2 Isolators (AIS)

The isolators shall comply to IEC 62271-102 in general. 765kV Isolator design shall be double break or vertical break or knee-type. 400 kV and 220kV Isolators shall be double break type. All Isolators and earth switches shall be motor operated. Earth switches shall be provided at various locations to facilitate maintenance. Isolator rated for 400kV and 220kV shall be of extended mechanical endurance class - M2 and suitable for bus transfer current switching duty as per IEC-62271-102. Main blades and earth blades shall be interlocked and interlock shall be fail safe type. 765kV, 400kV and 220kV earth switch for line isolator shall be suitable for induced current switching duty as defined for Class-B.

#### B.2.5.3 Current Transformers (AIS)

Current Transformers shall comply with IEC 61869 in general. All ratios shall be obtained by secondary taps only. Generally, Current Transformers (CT) for 765kV & 400kV shall have six cores (four for protection and two for metering) and 220kV Current Transformers shall have five cores (four for protection and one for metering). The burden and knee point voltage shall be in accordance with the requirements of the system including possible feeds for telemetry. Accuracy class for protection core shall be PX and for metering core it shall be 0.2S. The rated burden of cores shall be closer to the maximum burden

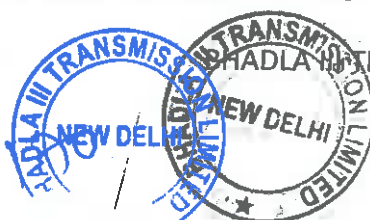



requirement of metering & protection system for better sensitivity and accuracy. The instrument security factor shall be less than 5 for CTs upto 400kV and less than 10 for CTs of 765kV voltage class.

#### B.2.5.4 Capacitor Voltage Transformers (AIS)

Capacitive Voltage transformers shall comply with IEC 61869 in general. These shall have three secondaries out of which two shall be used for protection and one for metering. Accuracy class for protection cores shall be 3P and for metering core shall be 0.2. The Capacitive voltage transformers on lines shall be suitable for Carrier Coupling. The Capacitance of CVT for 400kV and 220kV shall be of 4400/8800 pF depending on PLCC requirements whereas the Capacitance of CVT for 765kV shall be 8800 pF. The rated burden of cores shall be closer to the maximum burden requirement of metering & protection system (not more than 50VA for metering core) for better sensitivity and accuracy.

#### B.2.5.5 Surge Arresters (AIS)

624kV, 336kV Station High (SH) duty & 216kV Station Medium (SM) duty gapless type Surge arresters with thermal energy (Wth) of minimum 13 kJ/kV, 12 kJ/kV & 7 kJ/kV conforming to IEC 60099-4 in general shall be provided for 800kV, 420kV & 245kV systems respectively. Other characteristics of Surge arrester shall be chosen in accordance with system requirements. Surge arresters shall be provided near line entrances, transformers & Reactor so as to achieve proper insulation coordination. Surge Arresters shall be provided with porcelain/ polymer housing fitted with pressure relief devices. A leakage current monitor with surge counter shall be provided with each surge arrester.

#### B.2.6 Protection Relaying & Control System

The protective relaying system proposed to be provided for transmission lines, auto- transformers, reactors and bus bars to minimize the damage to the equipment in the events of faults and abnormal conditions, is dealt in this section. All main protective relays shall be numerical type with IEC 61850 communication interface and should have Interoperability during integration of numerical relays to communicate over IEC61850 protocol with RTU/SAS/IEDs of different OEMs. All numerical relays shall have built in disturbance recording feature.

The protection circuits and relays of transformer and reactor shall be electrically and physically segregated into two groups each being independent

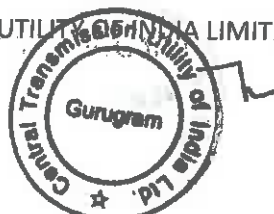

## Transmission Service Agreement

and capable of providing uninterrupted protection even in the event of one of the protection groups failing, to obtain redundancy, and to take protection systems out for maintenance while the equipment remains in service.

### a) Transmission Lines Protection

765kV, 400kV and 220kV lines shall have Main-I numerical three zone distance protection scheme with carrier aided inter-tripping feature. 765kV, 400kV and 220kV lines shall also have Main-II numerical distance protection scheme like Main-I but from different make that of Main-I. The Main-I and Main-II protection relays of same make may be provided only if they are of different hardware & manufacturing platform or different principle of operation.

However, Line Current Differential relay (with back up distance protection feature) as Main-I and Main-II shall be considered at both ends for short lines (line length below 30KM) having Fibre Optic communication link. Differential relay at remote end shall be provided by the TSP. Associated power & control cabling and integration with SAS at remote end shall be provided by respective bay owner.

In case of 220kV line bays where the line lengths are not indicated, Numerical Distance protection relay as Main-I and Line Current differential relay (with back up distance protection feature) as Main-II shall be provided. Further, in such case, the matching line current differential relay for remote end shall be provided by the remote end bay owner.

In case of loop in loop out of transmission lines, the existing protection scheme shall be studied and suitable up-gradation (if required) shall be carried out. Further, all 765kV, 400kV and 220kV lines shall be provided with single and three phase auto-reclosing facility to allow reclosing of circuit breakers in case of transient faults. These lines shall also be provided with distance to fault locators to identify the location of fault on transmission lines.

All 765kV, 400kV lines shall also be provided with two stages over voltage protection. Over voltage protection & distance to fault locator may be provided as in-built feature of Main-I & Main-II protection relays. Auto reclose as built-in function of Bay Control Unit (BCU) is also acceptable.

The Main-I and Main-II protection relays shall be fed from separate DC sources and shall be mounted in separate panels.

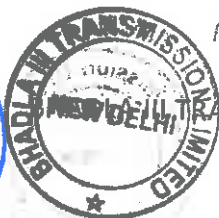

## Transmission Service Agreement

For 765kV, 400kV and 220kV transmission lines, directional IDMT earth fault relay should be provided as standalone unit or in-built feature of Main-I and Main -II feature.

### b) Auto Transformer Protection

These shall have the following protections:

- i) Numerical Differential protection
- ii) Numerical Restricted earth fault protection
- iii) Numerical Back-up Over-current and earth fault protection on HV & MV side
- iv) Numerical Over fluxing protection on HV & MV side
- v) Numerical Overload alarm
- vi) Numerical Back up Impedance protection (HV Side)

Further, Numerical Back-up Over-current and earth fault protection on HV & MV side of autotransformer shall not be combined with other protective functions (except back up Impedance protection) in the main relays and shall be independent relays. Besides these, power transformers shall also be provided with Buchholz relay, protection against high oil and winding temperature and pressure relief device etc.

Suitable monitoring, control (operation of associated circuit breaker & isolator) and protection for LT auxiliary transformer connected to tertiary winding of auto-transformer for the purpose of auxiliary supply shall be provided. The Over current and other necessary protection shall be provided for the auxiliary transformer. These protection and control may be provided as built in feature either in the bay controller to be provided for the auxiliary system or in the control & protection IEDs to be provided for autotransformer.

### c) 765kV & 400kV Reactor Protection

Reactor shall be provided with the following protections:

- i) Numerical Differential protection.
- ii) Numerical Restricted earth fault protection
- iii) Numerical Back-up impedance protection

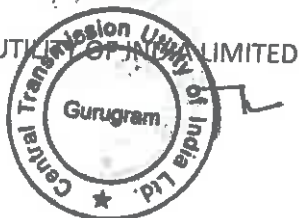

## Transmission Service Agreement

Besides these, reactors shall also be provided with Buchholz relay, MOG with low oil level alarm, protection against oil and winding temperatures & pressure relief device, etc.

### d) Bus bar Protection

The high speed low impedance type bus bar differential protection, which is essential to minimize the damage and maintain system stability at the time of bus bar faults, shall be provided for 765kV, 400kV and 220kV buses. Duplicated bus bar protection is envisaged for 765kV & 400kV bus-bar protection. Bus bar protection scheme shall be such that it operates selectively for each bus and incorporate necessary features required for ensuring security. The scheme shall have complete bus bar protection for present as well as future bays envisaged i.e. input / output modules for future bays shall also be provided.

Bus Bar protection system for new substation shall be de-centralized (distributed) type.

In case, the bus section is provided, then each side of bus section shall have separate set of bus bar protection schemes.

For existing substations, the existing bus bar protection shall be augmented as per requirement.

### e) Local Breaker Back up Protection

This shall be provided for each 765kV, 400kV and 220kV circuit breakers and will be connected to de-energize the affected stuck breaker from both sides.

#### Notes:

1. LBB & REF relays shall be provided separately from transformer differential relay.
2. LBB relay may also be provided as built-in protection function of distributed bus bar protection scheme; however, in such case separate LBB relay shall be provided for tie bays (in case of One and Half breaker scheme).
3. Over fluxing & overload protection can be provided as built-in feature of differential relay.
4. In 765kV & 400kV switchyard, if spare bay of half diameter is identified as future, Tie CB relay panel shall be with Auto-reclosure feature.

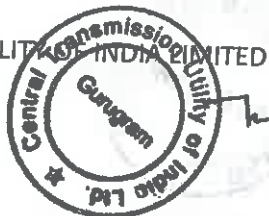

### B.2.7 Substation Automation System

- a) For all the new substations, state of art Substation Automation System (SAS) conforming to IEC-61850 shall be provided. The distributed architecture shall be used for Substation Automation system, where the controls shall be provided through Bay control units. The Bay control unit is to be provided bay wise for voltage level 220kV and above. All bay control units as well as protection units are normally connected through an Optical fibre high speed network. The control and monitoring of circuit breaker, dis-connector, re-setting of relays etc. can be done from Human Machine Interface (HMI) from the control room.

The functions of control, annunciation, disturbance recording, event logging and measurement of electrical parameters shall be integrated in Substation Automation System.

At new substations, the Substation Automation System (SAS) shall be suitable for operation and monitoring of the complete substation including proposed future bays/elements.

In existing substations with Substation automation system (SAS), augmentation of existing SAS shall be done for bays under present scope.

In existing Substations where Substation automation is not provided, control functions shall be done through control panels.

Necessary gateway & modems (as required) shall be provided to send data to RLDC/SLDC as per their requirement. Any augmentation work at RLDC/SLDC is excluded from TSP's scope. However, all the configuration work at substation end required to send data to RLDC/SLDC shall be in the scope of TSP.

### b) Time synchronisation equipment

Time synchronization equipment complete in all respect including antenna, cable, processing equipment required to receive time signal through GPS or from National Physical Laboratory (NPL) through INSAT shall be provided at new substations. This equipment shall be used to synchronize SAS & IEDs etc.

### B.3.0 Substation Support facilities

Certain facilities required for operation & maintenance of substations as described below shall be provided at new substation. In existing substation, these

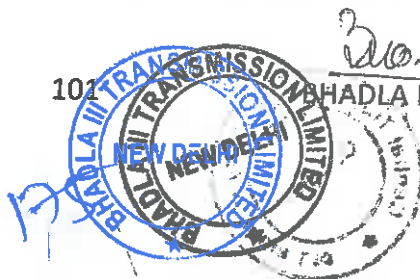
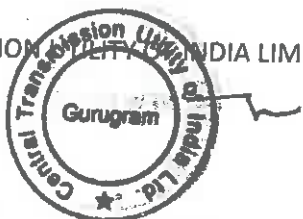



facilities have already been provided and would be extended/ augmented as per requirement.

### B.3.1 AC & DC power supplies

For catering the requirements of three phase & single phase AC supply and DC supply for various substation equipment for present and future scope, the following arrangement is envisaged:-

- (i) For LT Supply at each new Substation, two (2) nos. of LT Transformers (minimum 800kVA for substations with highest voltage rating as 765kV and minimum 630kVA for substations with highest voltage rating as 400kV) shall be provided from independent sources as per the CEA (Technical Standards for Connectivity to the Grid) Regulations, 2007.

Metering arrangement with Special Energy Meters (SEMs) shall be provided by TSP at 33kV tertiary of Transformer for drawing auxiliary supply at new substation. Such SEMs shall be provided by CTU at the cost of the TSP. Accounting of such energy drawn by the TSP shall be done by RLDC/RPC as part of Regional Energy Accounting.

Additionally, Active Energy Meters may be provided at the same point in the 33kV tertiary of Transformer by local SEB/DISCOM for energy accounting.

- (ii) 2 sets of 220V battery banks for control & protection and 2 sets of 48V battery banks for PLCC/ communication equipment shall be provided at each new Substation. Each battery bank shall have a float-cum-boost charger. At new substation, sizing of 220 V battery and battery charger shall be done based on the number of bays specified (including future bays) as per CEA (Technical Standards for construction of Electrical plants and Electrical Lines) Regulation no. 43 (3) (a) (i) and relevant IS. 2 sets of 48 V battery banks for PLCC and communication equipment shall be provided at each new Substation with at least 10-hour battery backup and extended backup, if required
- (iii) Suitable AC & DC distribution boards and associated LT Switchgear shall be provided at new substation.

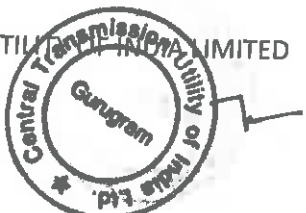

## Transmission Service Agreement

For new substation, following switch boards shall be considered with duplicate supply with bus coupler/ sectionalizer and duplicate outgoing feeders except for Emergency lighting distribution board which shall have only one incoming feeder:

- (a) 415V Main Switch board – 1 no.
- (b) AC distribution board – 1 no.
- (c) Main lighting distribution board – 1 no.
- (d) Emergency lighting distribution board – 1 no.
- (e) 220 Volt DC distribution board – 2 nos.
- (f) 48 Volt DC distribution board – 2 nos.

Sizing of LT Switchgear shall be suitable to cater the requirement for all present and future bays. AC & DC distribution boards shall have modules for all the feeders (including future as specified).

- (iv) At new Substation, one no. of DG set (minimum 500 kVA for substations with highest voltage rating as 765kV and minimum 250kVA for substations with highest voltage rating as 400kV) shall be provided for emergency applications.
- (v) For substation extensions, existing facilities shall be augmented as required.

### B.3.2 Fire Fighting System

Fire-fighting system for substation including transformer & reactor shall conform to CEA (Measures Relating to Safety & Electric Supply) Regulations.

Further, adequate water hydrants and portable fire extinguishers shall be provided in the substations. The main header of firefighting system shall be suitable for extension to bays covered under the future scope; necessary piping interface in this regard shall be provided.

At existing substations, the fire-fighting systems as available shall be extended to meet the additional requirements.

### B.3.3 Oil evacuating, filtering, testing & filling apparatus

To monitor the quality of oil for satisfactory performance of transformers, shunt reactors and for periodical maintenance necessary oil evacuating, filtering,

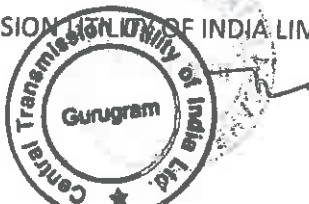

## Transmission Service Agreement

testing and filling apparatus would be provided at new substations. Oil storage tanks of adequate capacities for storage of transformer oil would be provided.

### B.3.4 Illumination

Normal & emergency AC & DC illumination shall be provided adequately in the control room & other buildings of the substation. The switchyard shall also be provided with adequate illumination.

Lighting of the entire control room building, fire-fighting pump house, other building (if any) and switchyard shall be done by LED based low power consumption luminaires.

### B.3.5 Control Room

For new substation, substation control room shall be provided to house substation work stations for station level control (SAS) alongwith its peripheral and recording equipment, AC & DC distribution boards, DC batteries & associated battery chargers, Fire Protection panels, Telecommunication panels & other panels as per requirements. Air conditioning shall be provided in the building as functional requirements. Main cable trenches from the control room shall have adequate space provision for laying of cables from control room for all the future bays also.

At existing substations, the adequacy of size of control room shall be ascertained and the same shall be augmented as per requirement.

### B.3.6 Control Concept

All the EHV circuit breakers in substation/switching stations shall be controlled and synchronized from the switchyard control room/remote control center. Each breaker would have two sets of trip circuits which would be connected to separate DC supplies for greater reliability. All the isolators shall have control from remote/local whereas the earth switches shall have local control only.

### B.3.7 Visual monitoring system (VMS) for watch and ward of substation premises:

Visual monitoring system for effective watch and ward of substation premises shall cover all the transformers and reactors, all other major AIS Equipment (such as CB, isolators, CT, CVT, SA etc. as applicable), GIS bays, panel room, all the gates of switchyard and all entry and exit points of control room building and



## Transmission Service Agreement

accordingly the location of cameras shall be decided. The camera shall be high definition color CCD camera with night vision feature. The VMS data partly/completely shall be recorded (minimum for 15 days) at least @25fps (or better) and stored on network video recorder. The system shall use video signals from various cameras installed at different locations, process them for viewing on workstations/monitors in the control room and simultaneously record all the cameras.

Mouse/keyboard controllers shall be used for pan, tilt, zoom and other functions of the desired camera. The Visual Monitoring System shall have provision of WAN connectivity for remote monitoring.

All camera recordings shall have Camera ID & location/area of recording as well as date/time stamp. The equipment should generally conform to Electromagnetic compatibility requirement for outdoor equipment in EHV substation.

At existing substations, the visual monitoring system if available shall be augmented as per existing or better specification as required.

### B.4 General Facilities

- a) Line Gantry/Towers are envisaged for bays under present scope only. However, for adjacent future line bay, tower shall be designed for extension (considering Quad conductors for 765kV & 400kV future lines and Twin conductor for 220 kV future lines) wherever applicable.
- b) Bay extension works at existing substation shall be executed by TSP in accordance with the requirement/provisions mentioned above. However, interface points shall be considered keeping in view the existing design/arrangement at the substation.
- c) TSP has to arrange for construction power and water on its own.
- d) All outdoor steel structures including anchor/foundation bolts shall be fully galvanized. The weight of the zinc coating shall be at least 610 gm/sq.m and 900 gm/sq.m for coastal/creek regions (if applicable).
- e) In 765kV & 400kV switchyard, if spare bay of half diameter is identified as future, all the equipment for Tie & Future bay shall be designed considering the current rating of line bay i.e. 3150A.

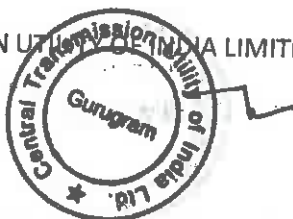

Transmission Service Agreement

- f) Boundary wall shall be brick masonry wall with RCC frame or Stone masonry wall or Precast RCC wall under present scope along the property line of complete substation area including future switchyard area to prevent encroachment and unauthorized access. Minimum height of the boundary wall shall be of 1.8m from finished ground level (FGL) as per CEA Measures Relating to Safety and Electric Supply Regulations.

**B.5 EXTENSION OF EXISTING SUBSTATION**

The following drawings/details of existing substation is attached with the RFP documents for further engineering by the bidder.

Sl. No.	Drawing Title	Drawing No./Details	Rev. No.
<b>A.</b>	<b>765kV Sikar-II (AIS) S/S</b>		
1.0	Single Line Diagram	Yet to be finalized by the developer. The same may be availed from the developer on finalization.	
2.0	General Arrangement		
3.0	Earthmat Layout		
4.0	Visual Monitoring System		
5.0	Bus Bar Protection (400kV System)		
6.0	Substation Automation System (SAS)		

Sl. No.	Drawing Title	Drawing No./Details	Rev. No.
<b>B.</b>	<b>400kV Fatehgarh-2 (AIS) S/S</b>		
1.0	Single Line Diagram	TPL-261-266-EL-AU001	Rev. No.- 02
2.0	General Arrangement	TPL-261-266-EL-GA-001	Rev. No.- 04
3.0	Earthmat Layout	TPL-261-266-EL-SE-001	Rev. No.- 02
4.0	Visual Monitoring System	Make: Verint	----
5.0	Bus Bar Protection (400kV System)	Make: GE Model: EB90-0324	----
6.0	Substation Automation System (SAS)	Make: Siemens	----

Bidder is also advised to visit the substation sites and acquaint themselves with the topography, infrastructure such as requirement of roads, cable trench, drainage etc. and also the design philosophy.

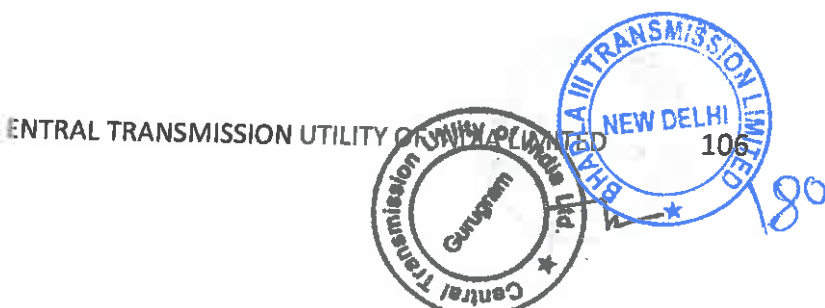



SPECIFIC TECHNICAL REQUIREMENTS FOR COMMUNICATION

The communication requirement shall be in accordance to CEA (Technical Standards for Communication System in Power System Operations) Regulations, 2020, CERC (Communication System for inter-State transmission of electricity) Regulations, 2017, and CEA (Cyber Security in Power Sector) Guidelines, 2021, all above documents as amended from time to time. The Protections for transmission line and the line compensating equipment shall have hundred percent back up communication channels i.e. two channels for tele- protection in addition to one channel for speech plus data for each direction.

In order to meet the requirement for grid management and operation of substations, Transmission Service Provider (TSP) shall conform to the following requirements:

**C.1.0 Fatehgarh-2 – Bhadla-3 400kV D/c line (Quad moose)**

On Fatehgarh-2 – Bhadla-3 400kV D/c line, TSP shall supply, install & commission One (1) number OPGW cable containing 24 Fibres (24F) on one E/W peak and conventional earth wire on other E/W peak.

The TSP shall install this OPGW from gantry of Fatehgarh-2 up to the gantry of Bhadla-3 S/s with all associated hardware including Vibration Dampers, mid-way and gantry Joint Boxes (called OPGW Hardware hereafter) and finally terminate in Joint Boxes at end Substations. The transmission line length is 200 kms (approx.) which can be managed as a repeater less link, however after survey link length may exceed to 200 kms. To meet link budget requirement of Fatehgarh-2 – Bhadla-3 link (including service loops and sag etc.) repeater may be required to be provided by TSP.

TSP shall finalize the location of repeater station depending upon the actual site conditions. Further TSP shall comply to the requirements mentioned as per Appendix-F.1.

Maintenance of OPGW Cable & OPGW Hardware shall be responsibility of TSP.

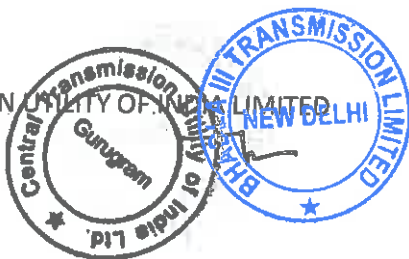

*2/10*

BHADLA III TRANSMISSION LIMITED

**C.2.0 Bhadla-3 – Sikar-II 765 kV D/c line**

On Bhadla-3 – Sikar-II 765 kV D/c line, TSP shall supply, install & commission One (1) number. OPGW cable containing 24 Fibres (24F) on one E/W peak and conventional earth wire on other E/W peak.

The TSP shall install this OPGW from gantry of Bhadla-3 up to the gantry of Sikar-II S/s with all associated hardware including Vibration Dampers, mid-way & gantry Joint Boxes (called OPGW Hardware hereafter) and finally terminate in Joint Boxes at the end Substations. The transmission line length is 380 kms (approx.) where repeater/s are required to meet link budget requirement of Bhadla-3 – Sikar-II link.

TSP shall finalize the location of repeater station depending upon the actual site conditions. Further TSP shall comply to the requirements mentioned as per Appendix-F.1.

Maintenance of OPGW Cable & OPGW Hardware shall be responsibility of TSP.

**C.3.0 Establishment of 2x1500 MVA 765/400kV & 3x500 MVA 400/220 kV pooling station at Bhadla-3 along with 2x330 MVar (765kV) Bus Reactor & 2x125 MVar (420kV) Bus Reactor**

- a. TSP shall supply, install & commission 3 no. FODP (96 F) alongwith panel and Approach Cable (24F each) with all associated hardware fittings from gantry tower to Control Room for all the incoming lines envisaged under the present scope.
- b. TSP shall supply, install & commission One or more STM-16 (FOTE) equipment alongwith panel/s supporting minimum ten (10) directions with MSP (Multiplex Section Protection – 1+1). These directions shall exclude protected (1+1) local patching among equipment (if any) at Bhadla-3 S/s. Communication Equipment shall be provided with necessary interfaces to meet the voice and data communication requirement among Bhadla-3, Sikar-II, Fatehgarh-2, Repeater Station/s & upcoming RE Plants. The suitable DC Power Supply and backup to be provided for communication equipment.
- c. FODP & FOTE equipment with panels shall be provided in Control Room at Bhadla-3 S/s. FOTE & FODP can be accommodated in same panel to optimize space at Control Room.

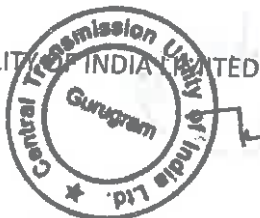

182



Transmission Service Agreement

- d. The new communication equipment under the present scope shall be compatible for integration with existing regional level centralized NMS. The local configuration of the new communication equipment shall be the responsibility of TSP. The configuration work in the existing centralized NMS for integration of new Communication equipment shall be done by Regional ULDC Team, however all the necessary support in this regard shall be ensured by TSP.
- e. TSP shall supply, install & commission required no. of Phasor Measurement Units (PMUs) for all 400kV and above voltage line bays (under the scope of this project) at Bhadla-3 S/s, these PMUs shall support latest IEEE C-37.118 protocols. These PMUs shall be provided with GPS clock and LAN switch and shall connect with LAN switch of control room with Fibre Optic cable. These PMUs shall be connected with the FOTE at Substation for onwards data transmission to the PDC (Phasor Data Concentrator) located at respective RLDC. However, configuration work in existing PDC at RLDC for new PMU integration is not in scope of TSP (shall be done by respective RLDC), however all the necessary support in this regard shall be ensured by TSP.
- f. TSP shall supply, install & commission Firewall in redundant mode (1+1) in line with the specification attached at Annexure F.1.
- g. The maintenance of all the communication equipment including FOTE, FODP, approach cable, PMUs, DCPS along with Battery Bank shall be the responsibility of TSP.

**C.4.0 2 no. of 400 kV line bays at Fatehgarh-2 for Fatehgarh-2 – Bhadla-3 400kV D/c line**

- i. TSP shall supply, install & commission 1 no. FODP (96 F) alongwith panel and required Approach Cable/s (24F) with all associated hardware fittings from gantry tower to Bay Kiosk and from the Bay Kiosk to Control room.
- ii. TSP shall supply, install & commission One STM-16 (FOTE) equipment alongwith panel/s supporting minimum three (3) directions with MSP (Multiplex Section Protection – 1+1) with necessary interfaces to meet the voice and data communication requirement between Fatehgarh-2 & Bhadla-3 S/s. The suitable DC Power Supply and backup to be provided for communication equipment.



*Mug.*

Transmission Service Agreement

iii. FOTE/FODP panel shall be installed in the new Bay Kiosk (Switchyard Panel Room (SPR)). The FOTE under present scope shall be integrated by TSP with the existing FOTE at control room of Fatehgarh-2 which shall be communicating with respective control center. TSP to provide necessary FODP sub rack / Splice trays/ Patch cords etc. and optical interfaces/equipment in the existing FOTE/FODP panels in control room for integration with the existing FOTE for onwards data transmission.

In case spare optical direction is not available in the existing FOTE at the control room, the TSP shall coordinate with station owner to reconfigure the directions in existing FOTE at control room. Alternatively, the TSP may integrate the FOTE under the present scope with existing FOTE in the nearby Kiosk connected to the control room FOTE (if available with spare direction). For this purpose, TSP shall provide necessary FODP sub rack / Splice trays/ Patch cords etc. and suitable optical interfaces/ equipment in the existing FOTE/FODP panels in another Kiosk (SPR).

iv. FOTE & FODP can be accommodated in same panel to optimize space.

v. The new communication equipment under the present scope shall be compatible for integration with existing regional level centralized NMS. The local configuration of the new communication equipment shall be the responsibility of TSP. The configuration work in the existing centralized NMS for integration of new Communication equipment shall be done by Regional ULDC Team, however all the necessary support in this regard shall be ensured by TSP.

vi. TSP shall supply, install & commission required no. of Phasor Measurement Units (PMUs) for all 400kV and above voltage line bays (under the scope of this project) at Fatehgarh-2 and PMUs shall support latest IEEE C-37.118 protocols. These PMUs shall be provided with GPS clock and LAN switch and shall connect with LAN switch of control room with Fibre Optic cable. These PMUs shall be integrated with the existing PDC (Phasor Data Concentrator) located at respective RLDC. Configuration work in existing PDC at RLDC for new PMU integration is not in scope of TSP (shall be done by respective RLDC), however all the necessary support in this regard shall be ensured by TSP. TSP shall provide separate WAMS (PMU, switches etc.) required for extended bays at Fatehgarh-2 S/s.



Transmission Service Agreement

- vii. The maintenance of all the communication equipment including FOTE, FODP, approach cable, repeaters, PMUs, DCPS alongwith Battery Bank shall be the responsibility of TSP.

**C.5.0 2 no. of 765 kV line bays at Sikar-II for Sikar-II – Bhadla-3 765kV D/c line**

- i. TSP shall supply, install & commission 1 no. FODP (96 F) alongwith panel and required Approach Cable (24F) with all associated hardware fittings from gantry tower to Bay Kiosk and from the Bay Kiosk to Control room.
- ii. TSP shall supply, install & commission One STM-16 (FOTE) equipment alongwith panel/s supporting minimum three (3) directions with MSP (Multiplex Section Protection – 1+1) with necessary interfaces to meet the voice and data communication requirement between Sikar-II & Bhadla-3 S/s. The suitable DC Power Supply and backup to be provided for communication equipment
- iii. FOTE/FODP panel shall be installed in the new Bay Kiosk (Switchyard Panel Room (SPR)). The FOTE under present scope shall be integrated by TSP with the existing/proposed FOTE at control room of Sikar-II which is communicating/ to be communicated with respective control center. TSP to provide necessary FODP sub rack / Splice trays/ Patch cords etc. and optical interfaces/equipment in the existing FOTE/FODP panels in control room for integration with the existing FOTE for onwards data transmission.

In case spare optical direction is not available in the existing FOTE at the control room, the TSP shall coordinate with station owner to reconfigure the directions in existing FOTE at control room. Alternatively, the TSP may integrate the FOTE under present scope with existing FOTE in the nearby Kiosk connected to the control room FOTE (if available with spare direction). For this purpose, TSP shall provide necessary FODP sub rack / Splice trays/ Patch cords etc. and suitable optical interfaces/ equipment in the existing FOTE/FODP panels in another Kiosk (SPR).

- iv. FOTE & FODP can be accommodated in same panel to optimize space.
- v. The new communication equipment under the present scope shall be compatible for integration with existing regional level centralized NMS. The local configuration of the new communication equipment shall be the responsibility of TSP. The configuration work in the existing centralized NMS for integration of new communication equipment shall be done by Regional





Transmission Service Agreement

ULDC Team, however all the necessary support in this regard shall be ensured by TSP.

- vi. TSP shall supply, install & commission install required no. of Phasor Measurement Units (PMUs) for all 400kV and above voltage line bays (under the scope of this project) at Sikar-II and PMUs shall support latest IEEE C-37.118 protocols. These PMUs shall be provided with GPS clock and LAN switch and shall connect with LAN switch of control room with Fibre Optic cable. These PMUs shall be integrated with the existing PDC (Phasor Data Concentrator) located at respective RLDC. Configuration work in existing PDC at RLDC for new PMU integration is not in scope of TSP (shall be done by respective RLDC), however all the necessary support in this regard shall be ensured by TSP. TSP shall provide separate WAMS (PMU, switches etc.) required for extended bays at Sikar-II.
- vii. The maintenance of all the communication equipment including FOTE, FODP, approach cable, repeaters, PMUs, DCPS along with Battery Bank shall be the responsibility of TSP.

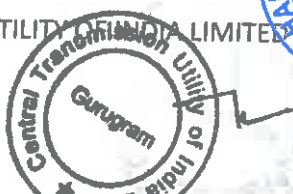

**C.6.0 PLCC & PABX:**

Power line carrier communication (PLCC) equipment complete for tele-protection commands and data channels shall be provided on each transmission line. The PLCC equipment shall in brief include the following:

- Coupling device, line traps, carrier terminals, protection couplers, HF cables, PABX (if applicable) and maintenance and testing instruments.
- At new substation, a telephone exchange (PABX) of 24 lines shall be provided at as means of effective communication among various buildings of the substation, remote end substations and with control centres (RLDC/SLDC) etc.
- Coupling devices shall be suitable for phase to phase coupling for 400kV Transmission lines. The pass band of coupling devices shall have sufficient margin for adding communication channel in future if required. Necessary protection devices for safety of personnel and low voltage part against power frequency voltages and transient over voltage shall also be provided.
- The line traps shall be broad band tuned suitable for blocking the complete range of carrier frequencies. Line Trap shall have necessary protective devices such as lightning arresters for the protection of tuning device. Decoupling network consisting of line traps and coupling capacitors may also be required at certain substation in case of extreme frequency congestion.
- The carrier terminals shall be of single side-band (SSB) amplitude modulation (AM) type and shall have 4 kHz band width. PLCC Carrier terminals and Protection couplers shall be considered for both ends of the line.
- PLCC equipment for all the transmission lines covered under the scheme (consisting of one set of analog PLCC channel along with circuit protection coupler and one set of Digital protection coupler for both ends) shall be provided by TSP. CVT & Wave trap for all the line bays under present scope shall be provided by TSP.
- All other associated equipment like cabling, coupling device and HF cable



Transmission Service Agreement

shall also be provided by the TSP.

2 sets of 48V battery banks for PLCC and communication equipment shall be provided at each new Substation with at least 10 hours battery backup and extended backup, if required.



188



### Repeater Requirements

- If the repeater location is finalized in the Control Room of a nearby substation, TSP shall provide 1 no. OPGW (48F) on a single Earthwire peak with OPGW Hardware & mid-way Joint Boxes etc. of the line crossing the main line and 1 no. Approach Cable (48F) with all associated hardware fittings, to establish connectivity between crossing point of main transmission line up to the repeater equipment in substation control room.

TSP shall co-ordinate for Space & DC power supply sharing for repeater equipment. TSP shall provide FODP, FOTE (with STM-16 capacity) with suitable interfaces require for link budget of respective link.

OR

- If the repeater location is finalized in the nearby substation premises, the TSP shall identify the Space for repeater shelter in consultation with station owner. Further TSP shall provide 1 no. OPGW (48F) on a single Earthwire peak with OPGW Hardware & mid-way Joint Boxes etc. of the line crossing the main line and 1 no. Approach Cable (48F) / UGFO (48F) with all associated hardware fittings, to establish connectivity between crossing point of main transmission line up to the substation where the repeater shelter is to be housed.

TSP shall provide repeater shelter along with FODP, FOTE (with STM-16 capacity) with suitable interfaces require for link budget of respective link, reliable power supply provisioning for AC and DC supply, battery bank, Air Conditioner and other associated systems.

OR

- If the repeater location is finalized on land near the transmission tower. TSP shall make the provisions for Land at nearby tower for repeater shelter. Further TSP shall provide 1 no. Approach Cable (48F) / UGFO (48F) with all associated hardware fittings to establish connectivity up to the location of repeater shelter.

TSP shall provide repeater shelter along with FODP, FOTE (with STM-16 capacity) with suitable interfaces require for link budget of respective link, reliable power supply provisioning for AC and DC supply, battery bank, Air Conditioner and other associated systems

Maintenance of OPGW Cable and OPGW Hardware, repeater equipment & all other items associated with repeater shelter shall be responsibility of TSP.

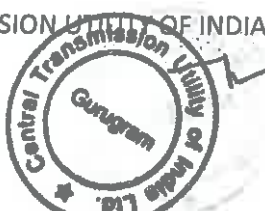

189



Transmission Service Agreement

Note: Existing Station owner/s to provide necessary support to integrate different equipment & applications of new extended bays with the existing substation e.g. Communication (through FOTE), PMUs, Voice etc. for smooth operation and monitoring of new added grid elements.

Proposed Communication for Transmission system for evacuation of power from REZ in Rajasthan (20 GW) under phase III –Part B1

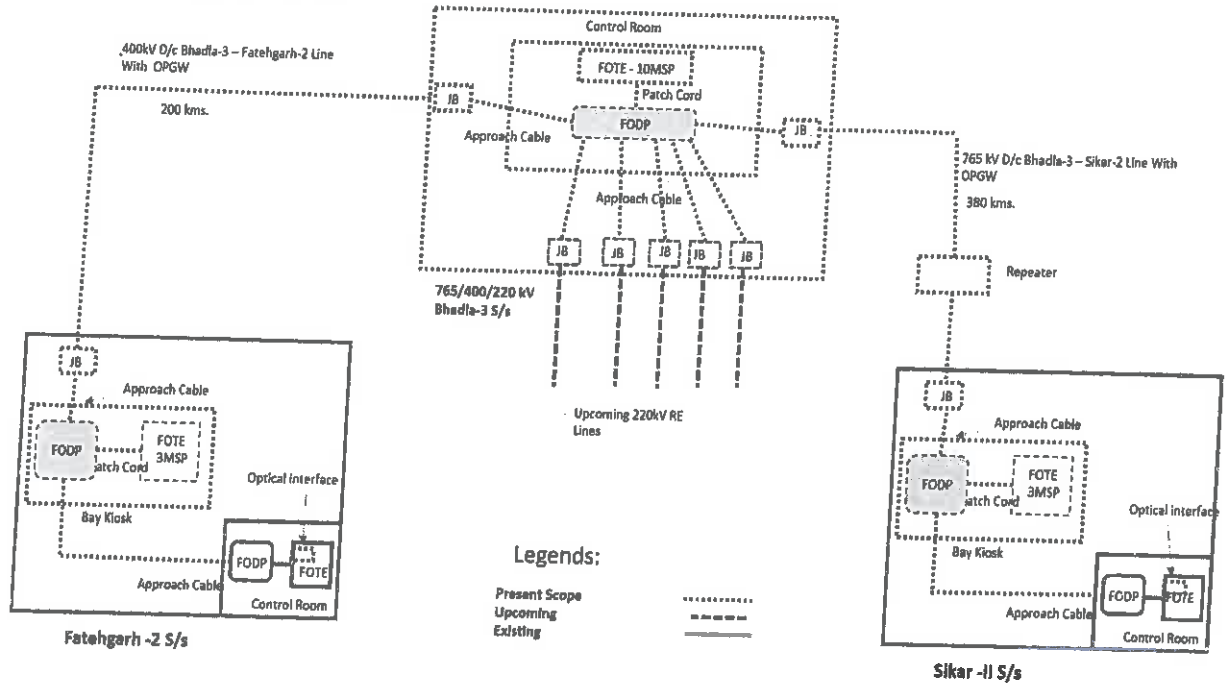
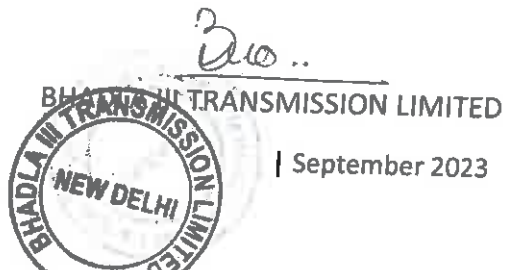
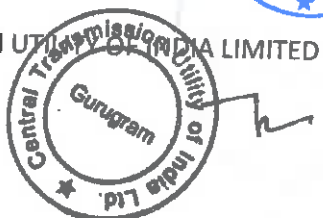

Figure-F.1



190



### Next Generation Firewall (NGFW)

TSP shall provide 2 nos. Next Generation Firewalls (NGFW); one No. Main & one No. Standby having electrical ethernet interfaces/ports and placed between FOTE & SAS gateway/s at the substation. All ethernet based applications (e.g. PMU, AMR, VOIP, SAS/SCADA etc.) shall be terminated in the firewall ports directly. Each port of firewall shall work as a separate zone. Firewall shall be hardware based with functionality of Block/Allow/drop and IPSec VPN (network encryption).

Minimum 16 Nos. of ports/interfaces shall be provided in each firewall (i.e. Main & Standby) TSP can use either single firewall or multiple firewalls to meet this interfaces requirement, each for main as well as standby firewall. Minimum throughput of firewall shall be 300 Mbps.

The Firewall shall be managed/ configured as standalone at present and shall also have compatibility to manage/configure through Centralized Management Console (CMC) remotely in future.

Firewall shall be tested and certified for ISO15408 Common Criteria for least EAL4+. Further, the OEM must certify that it conforms to Secure Product Development Life Cycle requirements as per IEC62443-4-1. The firewall shall generate reports for NERC-CIP Compliance.

The specifications for the firewalls are given at Annexure-F.2 and schematic diagram showing firewall placement given at Figure F.2.



191



*Dr.*

**Specifications of Next Generation Firewall (NGFW)**

1. NGFW shall have following features including but not limited to:
  - Encryption through IPsec VPN (Virtual Private Network), Deep Packet Inspection (DPI), Denial of service (DoS) & Distributed Denial of Service (DDoS) prevention, Port Block/ Allow, rules/ policies for block/allow, IP (Internet Protocol) & Media Access Control (MAC) spoofing protection, threat detection, Intrusion Prevention System (IPS), Anti-Virus, Anti-Spyware, Man In The Middle (MITM) attack prevention.
2. The proposed firewall shall be able to handle (alert, block or allow) unknown /unidentified applications e.g. unknown TCP & UDP packets. It shall have the provision to define application control list based on application group and/or list.
3. Firewall shall have feature and also have capability to update the definition/ Signatures of Anti-Virus online as well as offline. Firewall shall also be compatible to update the definitions/signatures through CMC. There shall be a defined process for security patching and firmware up-gradation. There shall be a feature to field validate firmware checksum. The same shall also be validated before using the OEM provided file/binary in the process of firmware up-gradation and security patching
4. Firewall shall have Management Console port to configure remotely.
5. Firewall shall be EMI/EMC compliant in Substation environment as per IEC 61850-3.
6. Firewall shall be rack mounted in existing standard equipment cabinets.
7. Firewall shall have support of SCADA applications (IEC-60870-5-104), ICCP, PMU (IEEE C37.118), Sub-Station Automation System (IEC 61850), Ethernet and other substation environment protocols.
8. Client based Encryption/ VPN must support different Operating System platforms e.g. Windows, Linux & Mac.
9. The solution must have content and comprehensive file detection policies, blocking the files as function of their types, protocols and directions.
10. Firewall shall have logging facility as per standard logs/events format. Firewall shall have features to export the generated/stored logs/events in csv (Comma Separated Value) and also any other standard formats for offline usage, analysis and compliance. Firewall shall have suitable memory architecture and solution to store and be enable to export all logs/events for a period of last 90 days at any given time.
11. Firewall shall have features and be compatible with local as well as central authentication system (RADIUS, LDAP, or TACACS+) for user account and



192



Transmission Service Agreement

- access right management. It shall also have Role Based User management feature.
12. Firewall shall have the capability to configure sufficient number of VLANs.
  13. Firewall shall have the capability to support sufficient number of sessions.
  14. Firewall shall have provision to configure multiple IP Sec VPNs, at least 100 nos., (one-to-many or many-to-one). Shall support redundant operation with a similar router after creation of all the IP Sec VPN. IPSec VPN shall support encryption protocols as AES128, AES256 and hashing algorithms as MD5 and SHA1. IPSec VPN throughput shall support at least 300 Mbps
  15. Firewall shall be capable of SNMP v3 for monitoring from Network Management system. It shall also have SNMPv3 encrypted authentication and access security
  16. Firewall shall support in Active/Passive or Active-Active mode with High Availability features like load balancing, failover for firewall and IPsec VPN without losing the session connectivity.
  17. Firewall should have integrated traffic shaping (bandwidth, allocation, prioritisation, etc.) functionality
  18. Shall support simultaneous operation with both IPv4 and IPv6 traffic
  19. Firewall shall be compatible with SNTP/NTP or any other standards for clock synchronization
  20. Firewall shall have the features of port as well as MAC based security
  21. Firewall shall support exporting of logs to a centralized log management system (e.g. syslog) for security event and information management.
  22. Firewall time shall be kept synchronised to official Indian Timekeeping agency, time.nplindia.org.
  23. Firewall product shall be provided with all applicable updates at least until 36 months since the applicable date of product shipping to the concerned utility.

CENTRAL TRANSMISSION UTILITY OF INDIA LIMITED

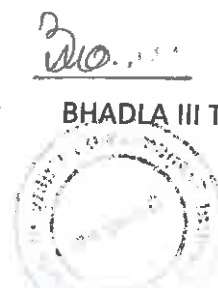

BHADLA III TRANSMISSION LIMITED

| September 2023

### Firewall Placement Diagram

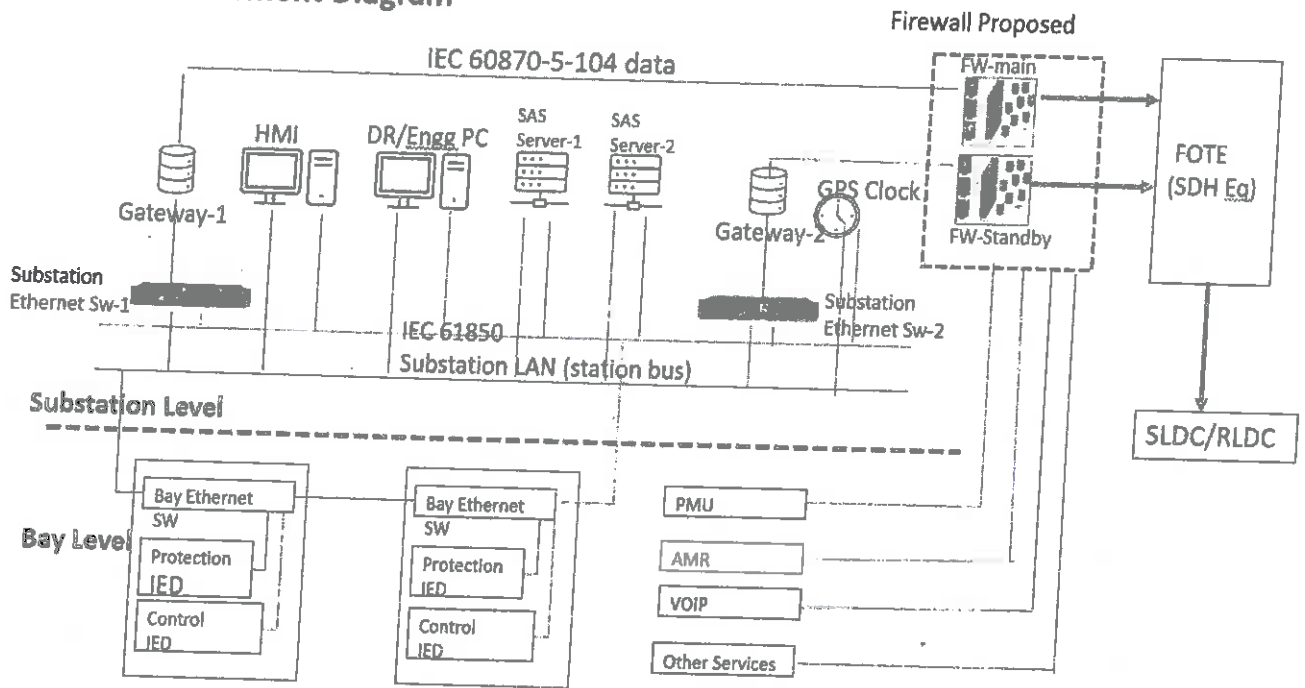
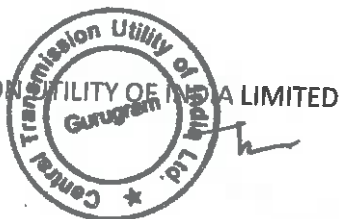

Figure F.2



194



*3/10*

## Schedule: 2

## Scheduled COD

[Note: As referred to in the definition of "Element", "Scheduled COD", and in Articles 3.1.3 (c), 4.1 (b) and 4.3 (a) of this Agreement]

S. No.	Name of the Transmission Element	Scheduled COD in months from Effective Date	Percentage of Quoted Transmission Charges recoverable on Scheduled COD of the Element of the Project	Elements which are pre-required for declaring the commercial operation (COD) of the respective Element
1.	Establishment of 2x1500 MVA 765/400kV & 3x500 MVA 400/220 kV pooling station at Bhadla-3 PS along with 2x330 MVar (765kV) Bus Reactor & 2x125 MVar (420kV) Bus Reactor	18 months	20.08%	Elements marked at Sl. No. 1, 2 & 3 are required to be commissioned simultaneously as their utilization is dependent on commissioning of each other.
2.	Bhadla-3 PS – Sikar-II S/s 765 kV D/c line along with 330 MVar Switchable line reactor for each circuit at each end of Bhadla-3 PS – Sikar-II S/s 765 kV D/c line		78.16%	
3.	2 nos. of 765kV line bays at Sikar-II S/s		1.76%	

## Note:

- (i) Provision of suitable sectionalization shall be kept at Bhadla-3 at 400 kV & 220 kV level to limit short circuit level.
- (ii) Developer of Sikar-II S/s to provide space for 2 nos. of 765 kV line bays at Sikar-II S/s along with space for switchable line reactors.
- (iii) Space provision for future 2 nos. 220kV Bus Coupler bay and 2 nos. Transfer Bus Coupler Bay shall be kept for bus switching scheme requirement.



121

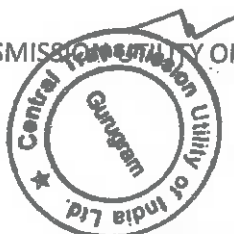

**Transmission Service Agreement**

The payment of Transmission Charges for any Element, irrespective of its successful commissioning on or before its Scheduled COD, shall only be considered after successful commissioning of the Element(s), which are pre-required for declaring the commercial operation of such Element as mentioned in the above table.

**Scheduled COD for the Project is: 18 months from the Effective Date.**

**[Note: List of Element(s) along with the critical Element(s) to be provided by CEA]**

CENTRAL TRANSMISSION UTILITY OF INDIA LIMITED



122

196



BHADLA III TRANSMISSION LIMITED

310.  
| September 2023



Schedule: 3

Safety Rules and Procedures

[Note: As referred to in Articles 5.6 of this Agreement]

1: Site Regulations and Safety:

The TSP shall establish Site regulations within sixty (60) days from fulfilment of conditions subsequent, as per Prudent Utility Practices setting out the rules to be observed till expiry of the Agreement at the Site and shall comply therewith.

Such Site regulations shall include, but shall not be limited to, rules in respect of security, safety of the Project, gate control, sanitation, medical care, and fire prevention, public health, environment protection, security of public life, etc.

Copies of such Site regulations shall be provided to the Nodal Agency and the CEA for the purpose of monitoring of the Project.

2: Emergency Work:

In cases of any emergency, the TSP shall carry out all necessary remedial work as may be necessary.

If the work done or caused to be done by any entity, other than the TSP, the TSP shall, reimburse the actual costs incurred, to the other Party carrying out such remedial works.

3: Site Clearance:

In the course of execution of the Agreement, the TSP shall keep the Site reasonably free from all unnecessary obstruction, storage, remove any surplus materials, clear away any wreckage, rubbish and temporary works from the Site, and remove any equipment no longer required for execution of the Agreement. After completion of all Elements of the Project, the TSP shall clear away and remove all wreckage, rubbish and debris of any kind from the Site, and shall leave the Site clean and safe.

4: Watching and Lighting:

The TSP shall provide and maintain at its own expense all lighting, fencing, and watching when and where necessary for the proper construction, operation, maintenance / repair of any of the Elements of the Project, or for the safety of the owners and occupiers of adjacent property and for the safety of the public, during such maintenance / repair.

CENTRAL TRANSMISSION UTILITY OF INDIA LIMITED  
Gurugram  
BHADLA III TRANSMISSION LIMITED  
NEW DELHI  
BHADLA III TRANSMISSION LIMITED  
NEW DELHI  
BHADLA III TRANSMISSION LIMITED  
NEW DELHI  
September 2023

## Schedule: 4

## Computation of Transmission Charges

## 1.1 General

The Monthly Transmission Charges to be paid to the TSP for providing Transmission Service for any Contract Year during the term of the Agreement shall be computed in accordance with this Schedule and paid as per Sharing Regulations.

Illustration regarding payment of Transmission Charges under various scenarios (considering definitions of Contract Year, Expiry Date & Monthly Transmission Charges above) is as below: -

Illustration-1: In case the Project Elements achieve COD as per Schedule

Quoted Transmission Charges: Rs. 140 Million

Completion Schedule:

Element No.	Completion Schedule in Months	Scheduled CoD of the Element	Actual CoD of the Element	% Charges recoverable on Scheduled CoD of the Element
Element 1	28	1-Feb-2018	1-Feb-2018	25%
Element 2	38	1-Dec-2018	1-Dec-2018	75%

Tariff Payable as follows:

Transmission Charges for Element 1			Transmission Charges for Element 2		
1-Feb-18 to 31-Mar-18	140 X 25% X ((28+31)/365)	5.65		--	0.00
1-Apr-18 to 30-Nov-18	140 X 25% X (244/365)	23.39		--	0.00
1-Dec-18 to 31-Mar-19	140 X 100% X (121/365)				46.41
2	140 X 100% X 1				140
3	140 X 100% X 1				140
4	140 X 100% X 1				140
5	140 X 100% X 1				140
.....					
.....					
36 (1-Apr to 30-Nov)	140 X 100% X (244/365)				93.59

Transmission Service Agreement

**Illustration-2: In case of extension of Scheduled COD as per Article 4.4.1 & 4.4.2 of this Agreement**

Quoted Transmission Charges: Rs. 140 Million

Completion Schedule:

Element No.	Completion Schedule in Months	Scheduled CoD of the Element	Actual CoD of the Element	% Charges recoverable on Scheduled CoD of the Element
Element 1	20	1-Feb-2018	1-Jul-2018	25%
Element 2	28	1-Oct-2018	1-Dec-2018	75%

Tariff Payable as follows:

Transmission Charges for Element 1			Transmission Charges for Element 2		
1-Feb-18 to 31-Mar-18	--	0.00		--	0.00
1-Apr-18 to 30-Jun-18	--	0.00		--	0.00
1-Jul-18 to 30-Nov-18	140 X 25% X (153/365)	14.67		--	0.00
1-Dec-18 to 31-Mar-19	140 X 100% X (121/365)				46.41
2	140 X 100% X 1				140
3	140 X 100% X 1				140
4	140 X 100% X 1				140
5	140 X 100% X 1				140
.....					
.....					
36 (1-Apr to 30-Nov)	140 X 100% X (244/365)				93.59

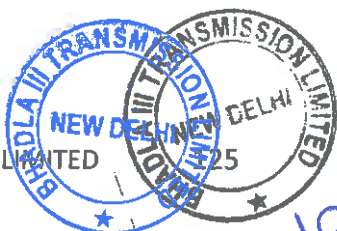

199

**Transmission Service Agreement**

**Illustration-3: In case of delay in achieving COD of Project & all individual Elements (COD of the Project achieved in Contract Year 1)**





Quoted Transmission Charges: Rs. 140 Million

Completion Schedule:

Element No.	Completion Schedule in Months	Scheduled CoD of the Element	Actual CoD of the Element	% Charges recoverable on Scheduled CoD of the Element
Element 1	20	1-Feb-2018	1-Dec-2018	25%
Element 2	28	1-Oct-2018	1-Dec-2018	75%

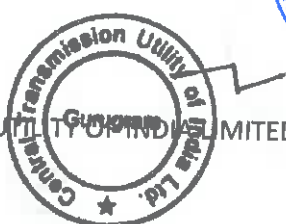
Tariff Payable as follows:

Transmission Charges for Element 1			Transmission Charges for Element 2		
1-Feb-18 to 31-Mar-18	--	0.00		--	0.00
1-Apr-18 to 30-Sept-18	--	0.00		--	0.00
1-Oct-18 to 30-Nov-18	--	0.00	1-Oct-18 to 30-Nov-18	--	0.00
1-Dec-18 to 31-Mar-19	140 X 100% X (121/365)				46.41
2	140 X 100% X 1				140
3	140 X 100% X 1				140
4	140 X 100% X 1				140
5	140 X 100% X 1				140
.....					
.....					
36 (1-Apr to 30-Nov)	140 X 100% X (244/365)				93.59





  
 CENTRAL TRANSMISSION UTILITY OF INDIA LIMITED      126      BHADLA III TRANSMISSION LIMITED

**Transmission Service Agreement**

**Illustration-4: In case of delay in achieving COD of Project & all individual Elements (COD of the Project achieved in Contract Year other than Contact Year 1)**

Quoted Transmission Charges: Rs. 140 Million

Completion Schedule:

Element No.	Completion Schedule in Months	Scheduled CoD of the Element	Actual CoD of the Element	% Charges recoverable on Scheduled CoD of the Element
Element 1	38	1-Oct-2019	1-May-2020	25%
Element 2	38	1-Oct-2019	1-May-2020	75%

Tariff Payment to be paid as:

Transmission Charges for Element 1			Transmission Charges for Element 2		
1-Oct-19 to 31-Mar-20	--	0.00	1-Oct-19 to 31-Mar-20	--	0.00
1-Apr-20 to 30-Apr-20	-	0.00	1-Apr-20 to 30-Apr-20	-	0.00
1-May-20 to 31-Mar-21	140 X 100% X (335/365)				128.49
2	140 X 100% X 1				140
3	140 X 100% X 1				140
4	140 X 100% X 1				140
5	140 X 100% X 1				140
.....					
.....					
36 (1-Apr to 30-Apr)	140 X 100% X (30/ 365)				11.51

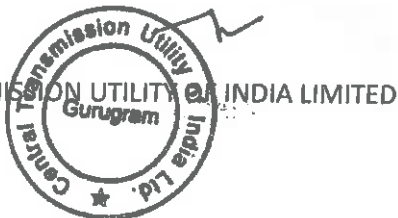

201

Transmission Service Agreement

Illustration5: In case of delay in achieving COD of Element but Project COD achieved on time

Quoted Transmission Charges: Rs. 140 Million

Completion Schedule:

Element No.	Completion Schedule in Months	Scheduled CoD of the Element	Actual CoD of the Element	% Charges recoverable on Scheduled CoD of the Element
Element 1	20	1-Feb-2018	1-Jul-2018	25%
Element 2	30	1-Dec-2018	1-Dec-2018	75%

Tariff Payable as follows:

Transmission Charges for Element 1			Transmission Charges for Element 2		
1-Feb-18 to 31-Mar-18	--	0.00		--	0.00
1-Apr-18 to 30-Jun-18	--	0.00		--	0.00
1-Jul-18 to 30-Nov-18	140 X 25% X (153/365)	14.67		--	0.00
1-Dec-18 to 31-Mar-19	140 X 100% X (121/365)				46.41
2	140 X 100% X 1				140
3	140 X 100% X 1				140
4	140 X 100% X 1				140
5	140 X 100% X 1				140
.....					
.....					
36 (1-Apr to 30-Nov)	140 X 100% X (244/365)				93.59

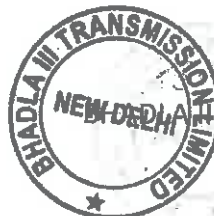
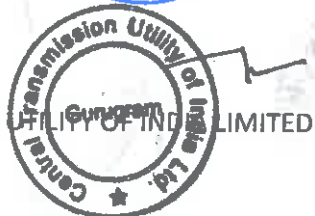

*Do.*

202



**Transmission Service Agreement**

**Illustration-6: In case of early commissioning of Project**

Quoted Transmission Charges: Rs. 140 Million

Completion Schedule:

Element No.	Completion Schedule in Months	Scheduled CoD of the Element	Actual CoD of the Element	% Charges recoverable on Scheduled CoD of the Element
Element 1	38	1-Oct-2019	1-Jul-2019	25%
Element 2	38	1-Oct-2019	1-Jul-2019	75%

Tariff Payment to be paid as:

Transmission Charges for Element 1		Transmission Charges for Element 2	
1-July-19 to 31-Mar-20	140 X 100% X (274/365)		105.09
2	140 X 100% X 1		140
3	140 X 100% X 1		140
4	140 X 100% X 1		140
5	140 X 100% X 1		140
.....			
.....			
36 (1-Apr to 30-Jun)	140 X 100% X (91/365)		34.91

**Illustration-7: In case of early commissioning of an element**

Quoted Transmission Charges: Rs. 140 Million

Completion Schedule:

Element No.	Completion Schedule in Months	Scheduled CoD of the Element	Actual CoD of the Element	% Charges recoverable on Scheduled CoD of the Element
Element 1	38	1-Oct-2019	1-Apr-2019	25%
Element 2	38	1-Jul-2019	1-Jul-2019	75%

Tariff Payment to be paid as:





CENTRAL TRANSMISSION UTILITY OF INDIA LIMITED | September 2023

**Transmission Service Agreement**

Transmission Charges for Element 1			Transmission Charges for Element 2		
1-Apr-2019 to 30-Jun-19	140 X 25% X (91/365)	8.72	1-Apr-2019 to 30-Jun-19	--	0.00
1-July-19 to 31-Mar-20	140 X 100% X (274/ 365)				105.09
2	140 X 100% X 1				140
3	140 X 100% X 1				140
4	140 X 100% X 1				140
5	140 X 100% X 1				140
.....					
.....					
36 (1-Apr-30-Jun)	140 X 100% X (91/365)				34.91

The Transmission Charges shall be payable on monthly basis as computed above.

**1.2 Computation of Monthly Transmission Charges**

The Monthly Transmission Charges for any month m in a Contract Year n shall be calculated as below:

For AC System:

- a. If Actual Transmission System Availability for the month m of contract year n is greater than or equal to 98% and less than or equal to 98.5%;

$$\text{Monthly Transmission Charges MTC}(m) = T_{mn} * 1$$

- a. If Actual Transmission System Availability for the month m of contract year n exceeds 98.5% and less than or equal to 99.75%;

$$\text{Monthly Transmission Charges MTC}(m) = T_{mn} * (AA / 98.5\%)$$

- c. If Actual Transmission System Availability for the month m of contract year n is greater than 99.75%;

$$\text{Monthly Transmission Charges MTC}(m) = T_{mn} * (99.75\% / 98.5\%)$$

- d. If Actual Transmission System Availability for the month m of contract year n is less than 98% and greater than or equal to 95.00%;

$$\text{Monthly Transmission Charges MTC}(m) = T_{mn} * (AA / 98\%)$$

- e. If Actual Transmission System Availability for the month m of contract year falls below 95%;

$$\text{Monthly Transmission Charges MTC}(m) = T_{mn} * (AA / 98\%) - 0.02 * (T_{mn} * (AA / 95\%))$$

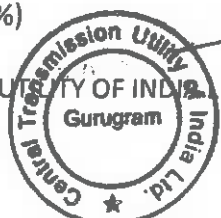

## Transmission Service Agreement

For DC System:

- a. If Actual Transmission System Availability for the month m of contract year n is greater than or equal to 95% and less than or equal to 96%;

$$\text{Monthly Transmission Charges MTC}(m) = T_{mn} * 1$$

- b. If Actual Transmission System Availability for the month m of contract year n exceeds 96% and less than or equal to 99.75%;

$$\text{Monthly Transmission Charges MTC}(m) = T_{mn} * (AA/ 96\%)$$

- c. If Actual Transmission System Availability for the month m of contract year n is greater than 99.75%;

$$\text{Monthly Transmission Charges MTC}(m) = T_{mn} * (99.75\% / 96\%)$$

- d. If Actual Transmission System Availability for the month m of contract year n is less than 95% and greater than or equal to 92.00%;

$$\text{Monthly Transmission Charges MTC}(m) = T_{mn} * (AA/ 95\%)$$

- e. If Actual Transmission System Availability for the month m of contract year falls below 92%;

$$\text{Monthly Transmission Charges MTC}(m) = T_{mn} * (AA/ 95\%) - 0.02 * (T_{mn} * (AA/ 92\%))$$

where:

- AA is the actual Availability, as certified by RPC, as per procedure provided in Schedule 6.
- m is the month in Contract Year 'n'
- $T_{mn}$  = Transmission Charges for the month 'm' in Contract Year 'n' = (Transmission Charge/ no. of days in the Year n)\* no. of days in month m

Provided, no Transmission Charges shall be paid during the period for which the RLDC has not allowed the operation of the Element/Project due to the failure of the TSP to operate it as per the provisions of the Grid Code.

### 1.3 RLDC Fee & Charges

The payment of RLDC fee & charges, in accordance with relevant regulations of CERC, shall be the responsibility of the TSP.



*Signature*  
BHADLA III TRANSMISSION LIMITED

205

Schedule: 5

Quoted Transmission Charges

[Quoted Transmission Charges from Annexure - 21 of the RFP of the Selected Bidder to be inserted here]

[To be incorporated from the Bid of the Selected Bidder submitted during the e-reverse auction after its selection]

Quoted Transmission Charges: Rs. 2124.08 Million

Proportionate Transmission Charges payable for each Element of the Project:

S. No.	Name of the Transmission Element	Percentage of Quoted Transmission Charges recoverable on Scheduled COD of the Element of the Project
1.	Establishment of 2x1500 MVA 765/400kV & 3x500 MVA 400/220 kV pooling station at Bhadla-3 PS along with 2x330 MVA (765kV) Bus Reactor & 2x125 MVA (420kV) Bus Reactor	20.08%
2.	Bhadla-3 PS – Sikar-II S/s 765 kV D/c line along with 330 MVA Switchable line reactor for each circuit at each end of Bhadla-3 PS – Sikar-II S/s 765 kV D/c line	78.16%
3.	2 nos. of 765kV line bays at Sikar-II S/s	1.76%



202



*Signature*

**Schedule: 6**

**Appendix –II of the Central Electricity Regulatory Commission (Terms and Conditions of Tariff) Regulations, 2019 as amended from time to time**

**Procedure for Calculation of Transmission System Availability Factor for a Month**

1. Transmission system availability factor for nth calendar month (“TAFPn”) shall be calculated by the respective transmission licensee, got verified by the concerned Regional Load Dispatch Centre (RLDC) and certified by the Member-Secretary, Regional Power Committee of the region concerned, separately for each AC and HVDC transmission system and grouped according to sharing of transmission charges. In case of AC system, transmission System Availability shall be calculated separately for each Regional Transmission System and inter-regional transmission system. In case of HVDC system, transmission System Availability shall be calculated on consolidate basis for all inter-state HVDC system.
2. Transmission system availability factor for nth calendar month (“TAFPn”) shall be calculated by consider following:
  - i) **AC transmission lines:** Each circuit of AC transmission line shall be considered as one element;
  - ii) **Inter-Connecting Transformers (ICTs):** Each ICT bank (three single phase transformer together) shall form one element;
  - iii) **Static VAR Compensator (SVC):** SVC along with SVC transformer shall form one element;
  - iv) **Bus Reactors or Switchable line reactors:** Each Bus Reactors or Switchable line reactors shall be considered as one element;
  - v) **HVDC Bi-pole links:** Each pole of HVDC link along with associated equipment at both ends shall be considered as one element;
  - vi) **HVDC back-to-back station:** Each block of HVDC back-to-back station shall be considered as one element. If associated AC line (necessary for transfer of inter- regional power through HVDC back-to-back station) is not available, the HVDC back-to-back station block shall also be considered as unavailable;
  - vii) **Static Synchronous Compensation (“STATCOM”):** Each STATCOM shall be considered as separate element.
3. The Availability of AC and HVDC portion of Transmission system shall be calculated by considering each category of transmission elements as under:

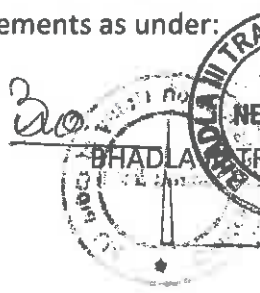
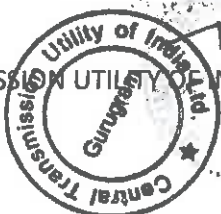

**Transmission Service Agreement**

**TAFMn (in %) for AC system:**

$$= \frac{(o \times AV_o) + (p \times AV_p) + (q \times AV_q) + (r \times AV_r) + (u \times AV_u)}{(o + p + q + r + u)} \times 100$$

Where,

- o = Total number of AC lines.
- AV<sub>o</sub> = Availability of o number of AC lines.
- p = Total number of bus reactors/switchable line reactors
- AV<sub>p</sub> = Availability of p number of bus reactors/switchable line reactors
- q = Total number of ICTs.
- AV<sub>q</sub> = Availability of q number of ICTs.
- r = Total number of SVCs.
- AV<sub>r</sub> = Availability of r number of SVCs
- u = Total number of STATCOM.
- AV<sub>u</sub> = Availability of u number of STATCOMs

**TAFMn (in %) for HVDC System:**

$$\frac{\sum_{x=1}^s C_{xpb}(\text{act}) \times AV_{xpb} + \sum_{y=1}^t C_{ybtb}(\text{act}) \times AV_{ybtb}}{\sum_{x=1}^s C_{xpb} + \sum_{y=1}^t C_{ybtb}} \times 100$$

Where

- C<sub>xpb</sub>(act) = Total actual operated capacity of x<sup>th</sup> HVDC pole
- C<sub>xpb</sub> = Total rated capacity of x<sup>th</sup> HVDC pole
- AV<sub>xpb</sub> = Availability of x<sup>th</sup> HVDC pole
- C<sub>ybtb</sub>(act) = Total actual operated capacity of y<sup>th</sup> HVDC back-to-back station block
- C<sub>ybtb</sub> = Total rated capacity of y<sup>th</sup> HVDC back-to-back station block
- AV<sub>ybtb</sub> = Availability of y<sup>th</sup> HVDC back-to-back station block
- s = Total no of HVDC poles
- t = Total no of HVDC Back to Back blocks

4. The availability for each category of transmission elements shall be calculated based on the weightage factor, total hours under consideration and non-available hours for each element of that category. The formulae for calculation of Availability of each category of the transmission elements are as per Appendix-III. The weightage

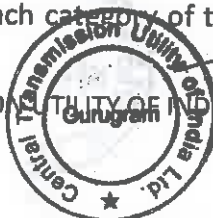

310



Transmission Service Agreement

factor for each category of transmission elements shall be considered as under:

- (a) For each circuit of AC line – Number of sub-conductors in the line multiplied by ckt-km;
  - (b) For each HVDC pole- The rated MW capacity x ckt-km;
  - (c) For each ICT bank – The rated MVA capacity;
  - (d) For SVC- The rated MVAR capacity (inductive and capacitive);
  - (e) For Bus Reactor/switchable line reactors – The rated MVAR capacity;
  - (f) For HVDC back-to-back station connecting two Regional grids- Rated MW capacity of each block; and
  - (g) For STATCOM – Total rated MVAR Capacity.
5. The transmission elements under outage due to following reasons shall be deemed to be available:
- i. Shut down availed for maintenance of another transmission scheme or construction of new element or renovation/ upgradation/ additional capitalization in existing system approved by the Commission. If the other transmission scheme belongs to the transmission licensee, the Member Secretary, RPC may restrict the deemed availability period to that considered reasonable by him for the work involved. In case of dispute regarding deemed availability, the matter may be referred to Chairperson, CEA within 30days.
  - ii. Switching off of a transmission line to restrict over voltage and manual tripping of switched reactors as per the directions of concerned RLDC.
6. For the following contingencies, outage period of transmission elements, as certified by the Member Secretary, RPC, shall be excluded from the total time of the element under period of consideration for the following contingencies:
- i) Outage of elements due to acts of God and force majeure events beyond the control of the transmission licensee. However, whether the same outage is due to force majeure (not design failure) will be verified by the Member Secretary, RPC. A reasonable restoration time for the element shall be considered by Member Secretary, RPC and any additional time taken by the transmission licensee for restoration of the element beyond the reasonable time shall be treated as outage time attributable to the transmission licensee. Member Secretary, RPC may consult the transmission licensee or any expert for estimation of reasonable restoration time. Circuits restored through ERS (Emergency Restoration System) shall be considered as available;
  - ii) Outage caused by grid incident/disturbance not attributable to the transmission licensee, e.g. faults in substation or bays owned by other agency causing outage of the transmission licensee's elements, tripping of lines,



September 2023

Transmission Service Agreement

ICTs, HVDC, etc. due to grid disturbance. However, if the element is not restored on receipt of direction from RLDC while normalizing the system following grid incident/disturbance within reasonable time, the element will be considered not available for the period of outage after issuance of RLDC's direction for restoration;

Provided that in case of any disagreement with the transmission licensee regarding reason for outage, same may be referred to Chairperson, CEA within 30 days. The above need to be resolved within two months:

Provided further that where there is a difficulty or delay beyond sixty days, from the incidence in finalizing the recommendation, the Member Secretary of concerned RPC shall allow the outage hours on provisional basis till the final view.

7. Time frame for certification of transmission system availability: (1) Following schedule shall be followed for certification of availability by Member Secretary of concerned RPC:

- Submission of outage data by Transmission Licensees to RLDC/constituents – By 5th of the following month;
- Review of the outage data by RLDC / constituents and forward the same to respective RPC– by 20th of the month;
- Issue of availability certificate by respective RPC – by 3rd of the next month.



Transmission Service Agreement

Appendix-III

FORMULAE FOR CALCULATION OF AVAILABILITY OF EACH CATEGORY OF TRANSMISSION ELEMENTS

For AC transmission system

$$AV_o(\text{Availability of } o \text{ no. of AC lines}) = \frac{\sum_{i=1}^o W_i(T_i - TNA_i)/T_i}{\sum_{i=1}^o W_i}$$

$$AV_q(\text{Availability of } q \text{ no. of ICTs}) = \frac{\sum_{k=1}^q W_k(T_k - TNA_k)/T_k}{\sum_{k=1}^q W_k}$$

$$AV_r(\text{Availability of } r \text{ no. of SVCs}) = \frac{\sum_{i=1}^r W_i(T_i - TNA_i)/T_i}{\sum_{i=1}^r W_i}$$

$$AV_p(\text{Availability of } p \text{ no. of Switched Bus reactors}) = \frac{\sum_{m=1}^p W_m(T_m - TNA_m)/T_m}{\sum_{m=1}^p W_m}$$

$$AV_u(\text{Availability of } u \text{ no. of STATCOMs}) = \frac{\sum_{n=1}^u W_n(T_n - TNA_n)/T_n}{\sum_{n=1}^u W_n}$$

$$AV_{x_{bp}}(\text{Availability of an individual HVDC pole}) = \frac{(T_x - TNA_x)}{T_x}$$

$$AV_{y_{btb}}(\text{Availability of an individual HVDC Back-to-back Blocks}) = \frac{(T_y - TNA_y)}{T_y}$$

For HVDC transmission system

For the new HVDC commissioned but not completed twelve months;

For first 12 months: [(AV<sub>x<sub>bp</sub></sub> or AV<sub>y<sub>btb</sub></sub>)x95%/85%], subject to ceiling of 95%.

Where,

- o = Total number of AC lines;
- AV<sub>o</sub> = Availability of o number of AC lines;
- p = Total number of bus reactors/switchable line reactors;
- AV<sub>p</sub> = Availability of p number of bus reactors/switchable line reactors;
- q = Total number of ICTs;
- AV<sub>q</sub> = Availability of q number of ICTs;
- r = Total number of SVCs;
- AV<sub>r</sub> = Availability of r number of SVCs;
- U = Total number of STATCOM;

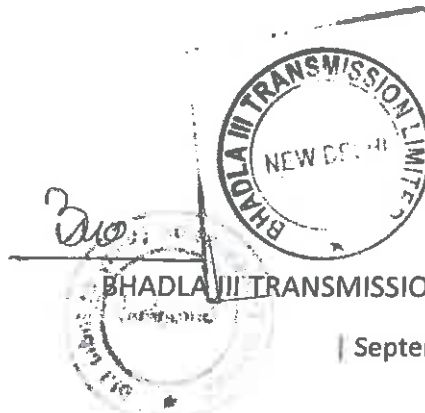
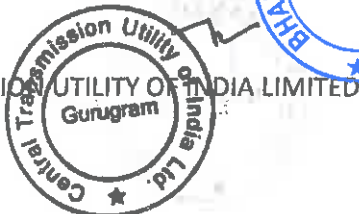

Transmission Service Agreement

AV<sub>u</sub> = Availability of u number of STATCOMs;  
 W<sub>i</sub> = Weightage factor for i<sup>th</sup> transmission line;  
 W<sub>k</sub> = Weightage factor for k<sup>th</sup> ICT;  
 W<sub>l</sub> = Weightage factors for inductive & capacitive operation of l<sup>th</sup> SVC;  
 W<sub>m</sub> = Weightage factor for m<sup>th</sup> bus reactor;  
 W<sub>n</sub> = Weightage factor for n<sup>th</sup> STATCOM.

T<sub>i</sub>, T<sub>k</sub>, T<sub>l</sub>, T<sub>m</sub>, T<sub>n</sub>, T<sub>x</sub>, T<sub>y</sub> = The total hours of i<sup>th</sup> AC line, k<sup>th</sup> ICT, l<sup>th</sup> SVC, m<sup>th</sup> Switched Bus Reactor & n<sup>th</sup> STATCOM, x<sup>th</sup> HVDC pole, y<sup>th</sup> HVDC back-to-back blocks during the period under consideration (excluding time period for outages not attributable to transmission licensee for reasons given in Para 5 of the procedure)

T<sub>NAi</sub>, T<sub>NAk</sub>, T<sub>NAl</sub>, T<sub>NAm</sub>, T<sub>NAx</sub>, T<sub>NAy</sub> = The non-availability hours (excluding the time period for outages not attributable to transmission licensee taken as deemed availability as per Para 5 of the procedure) for i<sup>th</sup> AC line, k<sup>th</sup> ICT, l<sup>th</sup> SVC, m<sup>th</sup> Switched Bus Reactor, n<sup>th</sup> STATCOM, x<sup>th</sup> HVDC pole and y<sup>th</sup> HVDC back-to-back block.

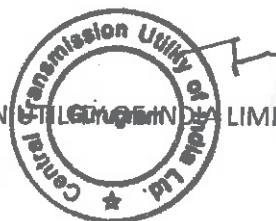

212



*Signature*

Transmission Service Agreement

Schedule: 7

Entire Bid (both financial bid and technical bid) of the Selected Bidder to be attached here

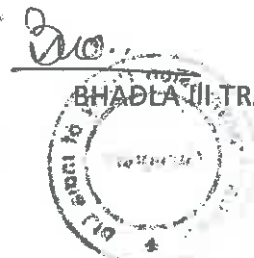
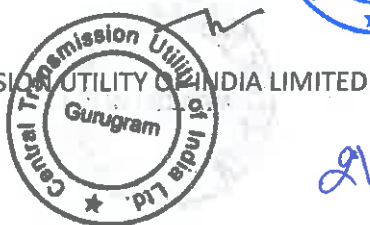

CENTRAL TRANSMISSION UTILITY OF INDIA LIMITED

BHADLA III TRANSMISSION LIMITED

| September 2023

Transmission Service Agreement

Schedule: 8

Contract Performance Guarantee

(To be on non-judicial stamp paper of appropriate value as per Stamp Act relevant to place of execution. Foreign entities submitting Bids are required to follow the applicable law in their country.)

In consideration of the .....[Insert name of the SPV or Selected Bidder on behalf of the TSP, or Lead Member in case of the Consortium, with address] agreeing to undertake the obligations under the Transmission Service Agreement dated .....and the other RFP Project Documents and the Nodal Agency and the .....[Insert the name of the BPC], agreeing to execute the *RFP Project Documents* with the Selected Bidder, regarding setting up the Project, the ..... [Insert name and address of the bank issuing the guarantee and address of the head office] (hereinafter referred to as "Guarantor Bank") hereby agrees unequivocally, irrevocably and unconditionally to pay to ..... (being the Nodal Agency) at .....[Insert the Place from the address of the Nodal Agency indicated in the TSA] forthwith on demand in writing from the Nodal Agency or any Officer authorized by it in this behalf, any amount up to and not exceeding Rupees ..... Crores (Rs. ....) only [Insert the amount of the bank guarantee] on behalf of M/s. .... [Insert name of the Selected Bidder or SPV].

This guarantee shall be valid and binding on the Guarantor Bank up to and including .....and shall not be terminable by notice or any change in the constitution of the Bank or the term of the Transmission Service Agreement or by any other reasons whatsoever and our liability hereunder shall not be impaired or discharged by any extension of time or variations or alternations made, given, or agreed with or without our knowledge or consent, by or between parties to the respective agreement.

Our liability under this Guarantee is restricted to Rs. .... Crores (Rs. ....) only. Our Guarantee shall remain in force until ..... [Insert the date of validity of the Guarantee as per Article 3.1.2 of this Agreement]. The Nodal Agency, shall be entitled to invoke this Guarantee up to three hundred sixty five (365) days of the last date of the validity of this Guarantee.

CENTRAL TRANSMISSION UTILITY OF INDIA LIMITED  
Gurugram



214



*Signature*

BHADLA I TRANSMISSION LIMITED

| September 2023



Transmission Service Agreement

The Guarantor Bank hereby expressly agrees that it shall not require any proof in addition to the written demand from ..... (in its roles as the Nodal Agency), made in any format, raised at the above mentioned address of the Guarantor Bank, in order to make the said payment to Nodal Agency.

The Guarantor Bank shall make payment hereunder on first demand without restriction or conditions and notwithstanding any objection by ..... [Insert name of the Selected Bidder], ..... [Insert name of the TSP] and / or any other person. The Guarantor Bank shall not require Nodal Agency to justify the invocation of this BANK GUARANTEE, nor shall the Guarantor Bank have any recourse against Nodal Agency in respect of any payment made hereunder.

**THIS BANK GUARANTEE** shall be interpreted in accordance with the laws of India.

The Guarantor Bank represents that this BANK GUARANTEE has been established in such form and with such content that it is fully enforceable in accordance with its terms as against the Guarantor Bank in the manner provided herein.

**THIS BANK GUARANTEE** shall not be affected in any manner by reason of merger, amalgamation, restructuring, liquidation, winding up, dissolution or any other change in the constitution of the Guarantor Bank.

**THIS BANK GUARANTEE** shall be a primary obligation of the Guarantor Bank and accordingly Nodal Agency shall not be obliged before enforcing this BANK GUARANTEE to take any action in any court or arbitral proceedings against ..... [Insert name of the SPV] or the Selected Bidder, as the case may be, to make any claim against or any demand on ..... [Insert name of the SPV] or the Selected Bidder, as the case may be, or to give any notice to ..... [Insert name of the SPV] or the Selected Bidder, as the case may be, or to enforce any security held by the Nodal Agency or to exercise, levy or enforce any distress, diligence or other process against ..... [Insert name of the SPV] or the Selected Bidder, as the case may be.

The Guarantor Bank acknowledges that this BANK GUARANTEE is not personal to Nodal Agency and may be assigned, in whole or in part, (whether absolutely or by way of security) by Nodal Agency to any entity to whom the Nodal Agency is entitled to assign its rights and obligations under the Transmission Service Agreement.

The Guarantor Bank hereby agrees and acknowledges that Nodal Agency shall have a right to invoke this Bank Guarantee either in part or in full, as it may deem fit.

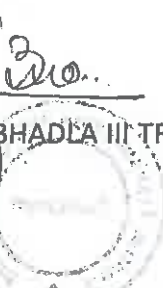
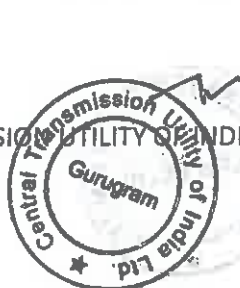

Transmission Service Agreement

Notwithstanding anything contained hereinabove, our liability under this Guarantee is restricted to Rs. .... Crores (Rs. ....) only and it shall remain in force until .....[Date to be inserted on the basis of Article 3.1.2 of the Transmission Service Agreement], with an additional claim period of three hundred sixty five (365) days thereafter. This BANK GUARANTEE shall be extended from time to time for such period, as may be desired by ..... [Insert name of the Selected Bidder or Lead Member in case of the Consortium or SPV]. We are liable to pay the guaranteed amount or any part thereof under this Bank Guarantee only if Nodal Agency serves upon us a written claim or demand.

In witness where of:

Signature .....

Name: .....

Power of attorney No.: .....

For:

..... [Insert Name of the Bank]

Banker's Seal and Full Address, including mailing address of the Head Office

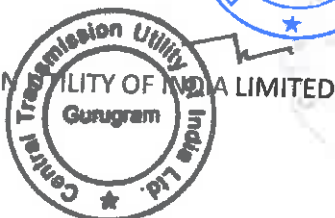

142

216



310

BHAOLA III TRANSMISSION LIMITED

| September 2023

Schedule: 9

Methodology for determining the Relief Under Force Majeure Event & Change in Law during Construction Period

The relief in the form of revision in tariff due to Force Majeure Event leading to extension of Scheduled COD for a period beyond one hundred eighty (180) days and/ or Change in Law during the construction period shall be as under:

$$\Delta T = [(P \times d)] \div [1 - (1 + d)^{-n}]$$

Where,

$\Delta T$  = Change in Transmission Charges for each year

P = Sum of cumulative increase or decrease in the cost of the Project due to Change in Law and interest cost during construction corresponding to the period exceeding one hundred eighty (180) due to Force Majeure Event leading to extension of Scheduled COD for a period beyond one hundred eighty (180) days

n = number of years over which the Transmission Charges has to be paid

d = Discount rate as notified by the CERC, applicable on the Bid Deadline

The increase in Transmission Charges as stated above shall be applicable only if the value of increase in Transmission Charges as calculated above exceeds 0.30% (zero point three percent) of the quoted Transmission Charges of the TSP.



*Signature*

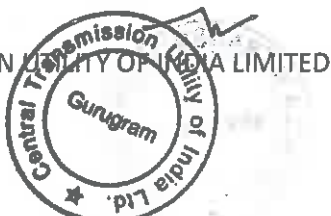

*Signature*



RESPONSE TO RFP  
FOR  
SELECTION OF BIDDER AS  
TRANSMISSION SERVICE PROVIDER  
THROUGH  
TARIFF BASED COMPETITIVE BIDDING  
PROCESS  
TO  
ESTABLISH INTER-STATE TRANSMISSION  
SYSTEM  
FOR  
TRANSMISSION SYSTEM FOR EVACUATION  
OF POWER FROM REZ IN RAJASTHAN  
(20GW) UNDER PHASE-III PART B1

*Submitted by*



POWER GRID CORPORATION OF INDIA LIMITED

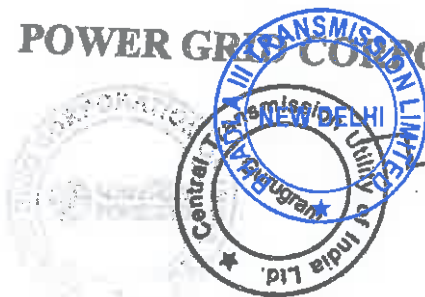

218



30  
दि. सुदर्शन  
SUDHARSHAN  
श्री. प्रबन्धक (सि.)/Sr. General Manager (Finance)  
पावरग्रिड के.का. / POWERGRID, CC



Date: 19/06/2023  
From: D Sudharshan Senior General Manager  
Power Grid Corporation of India Limited  
Saudamini, Plot No. 2, Sector 29, Gurgaon-122001 (Haryana)  
Tel. No.: 0124-2822093  
Fax No.: 0124-2571802  
E-mail address: [achoudhary@powergrid.in](mailto:achoudhary@powergrid.in), [tbc@powergrid.co.in](mailto:tbc@powergrid.co.in),  
[ppandey@powergrid.in](mailto:ppandey@powergrid.in), [sudarshan@powergrid.in](mailto:sudarshan@powergrid.in)

To,  
PFC Consulting Limited  
9th Floor, Wing-A, Statesman House,  
Connaught Place, New Delhi - 110001

Dear Sir,

Sub: Bid for selection of Bidder as Transmission Service Provider to establish Inter-State Transmission System for "Transmission system for evacuation of power from REZ in Rajasthan (20GW) under Phase-III Part B1" through tariff based competitive bidding process.

1. Being duly authorized to present and act on behalf of M/s Power Grid Corporation of India Limited (hereinafter called the "Bidder") and having read and examined in detail the Request for Proposal (RFP) document, the undersigned hereby submit our Technical Bid with duly signed formats and Financial Bid (Initial Offer) as stipulated in RFP document for your consideration.
2. It is confirmed that our Bid is consistent with all the requirements of submission as stated in the RFP document and subsequent clarifications/amendments as per Clause 2.3 and 2.4 of RFP
3. The information submitted in our Bid is complete, is strictly as per the requirements stipulated in the RFP document and is correct to the best of our knowledge and understanding. We would be solely responsible for any errors or omissions in our Bid.
4. We hereby agree and undertake to procure the products associated with the Transmission System as per provisions of Public Procurement (Preference to Make in India) orders issued by Ministry of Power vide orders No. 11/5/2018 - Coord. Dated 28.07.2020 for transmission sector, as amended from time to time read with Department for Promotion of Industry and Internal Trade (DPIIT) orders in this regard.



डि. सुदर्शन  
D. SUDHARSHAN  
वरिष्ठ वित्त प्रबंधक (वित्त)/Sr. General Manager (Finance)  
पावरग्रिड के.एम./ POWERGRID, GC

केन्द्रीय कार्यालय : सादामिनी, प्लॉट नं. 2, सेक्टर-29, गुरुग्राम-122001 (हरियाणा), दूरभाष : 0124-2822000, 2823000  
Corporate Office : "Saudamini", Plot No. 2, Sector-29, Gurugram-122001, (Haryana) Tel. : 0124;2822000, 2823000

पंजीकृत कार्यालय : बी-9, कुतुब इंस्टीट्यूशनल एरिया, कटवारिया सराय, नई दिल्ली-110016 011-26560112, 26564812, 26564892, सीआईएन : L40101DL1989G01038121  
Registered Office : B-9, Qutab Institution Area, Katwaria Sarai, New Delhi-110016. Tel.: 011-26560112, 26564812, 26564892, CIN : L40101DL1989G01038121  
Website : www.powergrid.in

219

We hereby also agree and undertake to comply with Department of Expenditure, Ministry of Finance vide Order (Public Procurement No. 1) bearing File No. 6/18/2019-PPD dated 23.07.2020, Order (Public Procurement No. 2) bearing File No. 6/18/2019-PPD dated 23.07.2020 and Order (Public Procurement No. 3) bearing File No. 6/18/2019-PPD, dated 24.07.2020, as amended from time to time, regarding public procurement from a bidder of a country, which shares land border with India.

5. We hereby agree to comply with Ministry of Power order no. 25-11/6/2018 – PG dated 02.07.2020 as amended from time to time.
6. We are herewith submitting legally binding board resolution for the total equity requirement of the Project.
7. [NOT APPLICABLE]
8. We confirm that there are no litigations or disputes against us, which materially affect our ability to fulfill our obligations with regard to the Project.
9. We hereby confirm that we shall continue to maintain compliance with Qualification Requirements till the execution of the Transmission Service Agreement. Further, in case we emerge as Selected Bidder for the Project, we shall continue to maintain compliance with Qualification Requirements till the COD of the Project.
10. We confirm that we have studied the provisions of relevant Indian laws and regulations required to enable us to build, own, operate and transfer the said Project and to prepare this Bid.
11. We hereby confirm that we shall abide unreservedly with BPC's decision in the qualification process for selection of Qualified Bidder and further warrant that under no circumstances we shall challenge either the BPC's decision or its right to make such decision at any time in the future.
12. We confirm that the Bid shall remain valid for a period of one eighty (180) days from the Bid Deadline.
13. The details of contact person are furnished as under:  
Name: D Sudharshan  
Designation: Senior General Manager  
Name of the Company: Power Grid Corporation of India Limited  
Address of the Bidder: Saudamini, Plot No. 2, Sector 29, Gurgaon-122001 (Haryana)  
Phone Nos.: 0124-2822093, Mob: 9449599097  
Fax Nos.: 0124-2571802  
E-mail address: achoudhary@powergrid.in, tbcb@powergrid.co.in,  
ppandey@powergrid.in, sudarshan@powergrid.in

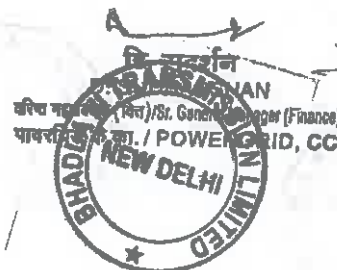
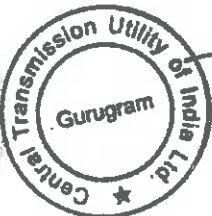



14. Bid Bond

We have enclosed a Bid Bond of Rupees Forty Crore Only (Rs.40 Crore), in the form of bank guarantee no.1731323BC.0000762 dated...19/06/2023... as per your proforma (Annexure-14) from...State Bank of India... and valid up to ...17/07/2024...in terms of Clause 2.11 of the RFP.

15. Acceptance

We hereby unconditionally and irrevocably agree and accept that the decision made by the BPC on any matter regarding or arising out of the RFP shall be binding on us. We hereby expressly waive any and all claims in respect of Bid process.

16. Familiarity with Relevant Indian Laws & Regulations

We confirm that we have studied the provisions of relevant Indian laws and regulations as required to enable us to submit this Bid and execute the RFP Project Documents (other than TSA), in the event of our selection as the TSP. We further undertake and agree that all such factors as mentioned in Clause 2.5.7 of RFP have been fully examined and considered while submitting the Bid.

It is confirmed that our Bid is consistent with all the requirements of submission as stated in the RFP and subsequent communications from BPC.

The information submitted in our Bid is complete, strictly as per the requirements stipulated in the RFP and is correct to the best of our knowledge and understanding. We would be solely responsible for any errors or omissions in our Bid.

We confirm that we have not taken any deviation so as to be deemed non-responsive with respect to the provisions stipulated at Clause 2.5.1, of this RFP

Thanking you,

Yours sincerely,

.....  
(Name and Signature of the Bidder)  
D. SUDHARSHAN  
Senior General Manager  
POWERGRID, CC

Name: D Sudharshan  
Designation: Senior General Manager  
Address: Power Grid Corporation of India Ltd.,  
Saudamini, Plot No. 2, Sector 29, Gurgaon-122001 (Haryana)

Date: 19/06/2023  
Place: Gurgaon

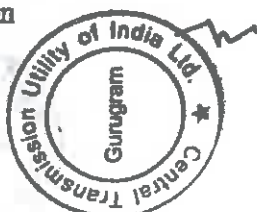

4  
221



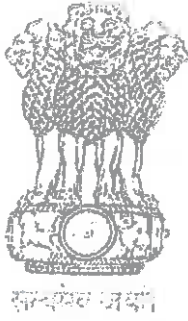

INDIA NON JUDICIAL

Government of National Capital Territory of Delhi

e-Stamp

Certificate No. : IN-DL91588441842853U
Certificate Issued Date : 16-Feb-2022 04:52 PM
Account Reference : IMPACC (IV)/ d1959903/ DELHI/ DL-DLH
Unique Doc. Reference : SUBIN-DL95990372987884382665U
Purchased by : POWER GRID CORPORATION OF INDIA LIMITED
Description of Document : Article Others
Property Description : Not Applicable
Consideration Price (Rs.) : 0 (Zero)
First Party : POWER GRID CORPORATION OF INDIA LIMITED
Second Party : Not Applicable
Stamp Duty Paid By : POWER GRID CORPORATION OF INDIA LIMITED
Stamp Duty Amount(Rs.) : 100 (One Hundred only)

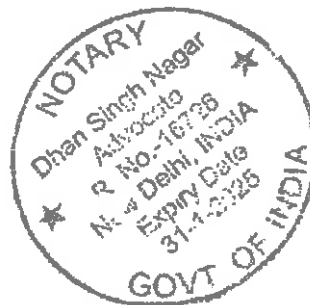
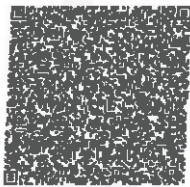

Please write or type below this line

POWER OF ATTORNEY

Know all men by these presents, We Power Grid Corporation of India Limited having its registered office at B-9, Qutab Institutional Area, Katwaria Sarai, New Delhi - 110016 do hereby constitute, appoint and authorize Mr. Dharanikota Sudharshan residing at Flat no B2/ 201, PWO, Next to Hanuman Mandir, Sector 43, Gurgaon, Haryana - 122009 who is presently employed with us and holding the position of Senior General Manager as our attorney, to do in our name and on our behalf, all such acts, deeds and things necessary in connection with or incidental to our Bid for selection of Bidder as Transmission Service Provider to establish Inter-State

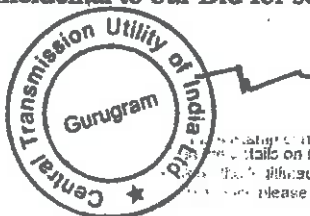

Handwritten signature

This certificate should be verified at www.echidna.com or using e-Stamp Mobile App. Details on this Certificate and as available on the website / mobile App renders it invalid. The liability is on the users of the certificate. Please inform the Competent Authority

Transmission System for "Transmission system for evacuation of power from REZ in Rajasthan (20 GW) under phase III-Part B1" through tariff based competitive bidding process in the country of India, including signing and submission of all documents related to the Bid, including, undertakings, letters, certificates, acceptances, clarifications, guarantees, etc., making representations to the BPC, and providing information/ responses to the BPC, representing us in all matters before the BPC, and generally dealing with the BPC in all matters in connection with our Bid for the said Project till the completion of the bidding process in accordance with the RFP and signing of the Share Purchase Agreement by all the parties thereto.

We hereby agree to ratify all acts, deeds and things lawfully done by our said attorney pursuant to this Power of Attorney and that all acts, deeds and things done by our aforesaid attorney shall and shall always be deemed to have been done by us.

All the terms used herein but not defined shall have the meaning ascribed to such terms under the RFP.

For Power Grid Corporation of India Limited

.....  
(Signature) *Abhay Choudhary*  
ABHAY CHOUDHARY  
Director (Projects)  
POWERGRID

Name: Abhay Choudhary  
Designation: Director (Projects)

Accepted

.....  
(Signature of the Attorney)

Name: Dharanikota Sudharshan  
Designation: Senior General Manager  
Address: Flat no B2/ 201, PWO Next to Hanuman Mandir, Sector 43, Gurgaon,  
Haryana - 122009



.....  
Specimen signatures of attorney attested by the Executant

.....  
(Signature of the Executant) *Abhay Choudhary*  
ABHAY CHOUDHARY  
Director (Projects)  
POWERGRID

Name: Abhay Choudhary  
Designation: Director (Projects)

ATTESTED  
*[Signature]*  
NOTARY PUBLIC  
NEW DELHI, (INDIA)

.....  
(Signature of Notary Public)

20 MAY 2022

Place: New Delhi  
Date: 20/05/2022

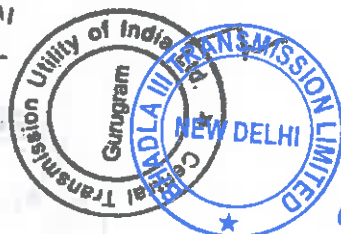

6  
223

# Board Resolution

## (Extracts from Minutes of Board Meeting)



  
**डि. सुदर्शन**  
**D. SUDHARSHAN**  
वरिष्ठ वित्तप्रबन्धक (सि.मं)/Sr. General Manager (Finance)  
पावरग्रिड के.एन. / POWERGRID, CC

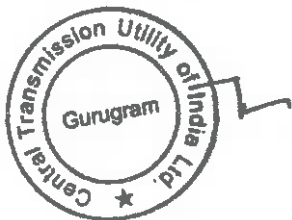

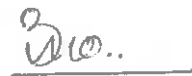



7  
224



**Certified True Copy of the Resolution passed at the 402<sup>nd</sup> Meeting of Board of Directors of POWERGRID held on Sunday, 27<sup>th</sup> March, 2022 at 10:55 a.m. at POWERGRID's Residential Complex, Sector 43, Gurgaon, Haryana-122001.**

Item No. 402.2.2: -

**Submission of Response to Request for Proposal (RFP) for selection of Bidder as Transmission Service Provider (TSP) through tariff based competitive bidding process to establish Inter-State Transmission System for Three (03) projects floated by PFC Consulting Limited (PFCL) and Acquisition of the SPV(s) in the event of POWERGRID emerging as the Successful Bidder in any of the Three (03) Transmission Projects under TCB:-**

X X X X  
The Board, after discussion, at the duly convened Meeting on 27<sup>th</sup> March 2022, with the consent of all the Directors present and in compliance of the provisions of the Companies Act, 2013, passed the following Resolution:

**i. Submission of Response to Request for Proposal (RFP) – 'Transmission system for evacuation of power from REZ In Rajasthan (20GW) under Phase-III Part B1':-**

(i) "Resolved that approval of the Board be and is hereby accorded for POWERGRID's participation in the Tariff based competitive bidding for selection of Bidder as Transmission Service Provider (TSP) through tariff based competitive bidding process to establish Inter-State Transmission System for 'Transmission system for evacuation of power from REZ In Rajasthan (20GW) under Phase-III Part B1'."

(ii) "Resolved that pursuant to the provisions of the Companies Act, 2013 and compliance thereof and as permitted under the Memorandum and Articles of Association of the company, approval of the Board be and is hereby accorded for investment of 100 % (One Hundred per cent) of the total equity share capital of SPV [as incorporated by BPC] representing the entire amount proposed to be invested by the company for the transmission system for "Transmission system for evacuation of power from REZ In Rajasthan (20GW) under Phase-III Part B1", partly by acquisition of the existing equity shares from PFC Consulting Limited and/or partly by subscribing to the new equity shares, as per the terms of the RFP."

(iii) "Resolved that Smt. Seema Gupta, Director (Operations)/ Shri V K Singh, Director (Personnel)/ Shri Mohammed Taj Mukarrum, Director (Finance)/ Shri Abhay Choudhary, Director (Projects) – the whole time directors of the company, be and are hereby severally authorised to take all the steps required for submission of the Bid as per the RFP documents for selection



केन्द्रीय कार्यालय: 'सौदाखिनी', प्लॉट नं. 29, सेक्टर-43, गुरुगढ़-122001, (हरियाणा) दूरभाष: 0124-2571700-719  
Corporate Office: "Saudakhini", Plot No. 29, Sector-43, Gurgaon-122001, (Haryana) Tel: 0124-2571700-719  
पंजीकृत कार्यालय: बी-9, कुतुब ईस्तेमदुल्लाह चौक, पश्चिम बंगाल, नई दिल्ली-110 016, दूरभाष: 011-26560112, 26560121, 26564812, 26564892, CIN: L10101DL1989GO0038121  
Registered Office: B-9, Qutub-ud-Daulah Chowk, West Bengal, New Delhi-110 016. Tel: 011-26560112, 26560121, 26564812, 26564892  
225  
D. SUDHARSHAN  
वरिष्ठ वित्तप्रबंधक (वित्त)/Sr. General Manager (Finance)  
पावरग्रिड के.फा./ POWERGRID, CC



of Bidder as Transmission Service Provider (TSP) through tariff based competitive bidding process to establish Inter-State Transmission System for "Transmission system for evacuation of power from REZ in Rajasthan (20GW) under Phase-III Part B1" .

- (iv) "Further Resolved that Shri A K Singhal, Executive Director / Shri B Vamsi Rama Mohan, Chief General Manager / Shri Dharanikota Sudharshan, Senior General Manager be and are hereby severally authorized to take all the steps required to be taken by the Company for submission of the Bid, including in particular, signing of the Bid, Bid Security Declaration, if any etc., making changes thereto and submitting amended Bid, all the documents related to the Bid, certified copy of this Board resolution or letter or undertakings etc, required to be submitted to BPC as part of the Bid or such other documents as may be necessary in this regard.

"Further Resolved that the Chairman & Managing Director/ Director (Operations)/ Director (Projects)/ Director (Personnel)/ Director (Finance) be and are hereby severally authorized to issue the Power of Attorney in this regard as per the format of the RFP documents for selection of Bidder as Transmission Service Provider (TSP) through tariff based competitive bidding process to establish Inter-State Transmission System for "Transmission system for evacuation of power from REZ In Rajasthan (20GW) under Phase-III Part B1" and the same be issued in line with Company policy and requirement of the RFP documents for Tariff based competitive bidding."

**Certified to be true copy**

  
**(Mrinal Shrivastava)**  
**Company Secretary**

शुभल शिवशर्मा / MRINAL SHRIVASTAVA  
कम्पनी सचिव / Company Secretary  
पावर ग्रिड कॉर्पोरेशन ऑफ इंडिया लिमिटेड  
Power Grid Corporation of India Ltd.  
(भारत सरकार का उद्यम) / (A Govt. of India Enterprise)  
प्लॉट सं-2, सेक्टर-29, गुरुग्राम-122 001 (हरियाणा)  
Plot No.-2, Sector-29, Gurgaon- 122 001 (Haryana)

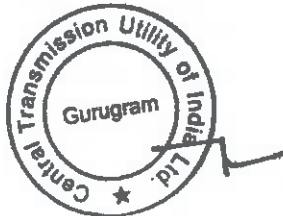



**Certified True Copy of amended Resolution No. I. (ii) dated 8<sup>th</sup> May, 2023 which was earlier approved by the Board of Directors in duly convened 402<sup>nd</sup> Meeting of Board of Directors of POWERGRID held on Sunday, 27<sup>th</sup> March, 2022 at 10:55 a.m. at POWERGRID's Residential Complex, Sector 43, Gurgaon, Haryana-122001.**

**Item No. 402.2.2: -**

**Submission of Response to Request for Proposal (RFP) for selection of Bidder as Transmission Service Provider (TSP) through tariff based competitive bidding process to establish Inter-State Transmission System for Three (03) projects floated by PFC Consulting Limited (PFCL) and Acquisition of the SPV(s) In the event of POWERGRID emerging as the Successful Bidder in any of the Three (03) Transmission Projects under TBCB:-**

X X X X  
Certified True Copy of amended Resolution No. I. (ii) dated 8<sup>th</sup> May, 2023 which was earlier approved with the consent of all Directors at their duly convened 402<sup>nd</sup> Meeting which was held on 27<sup>th</sup> March, 2022 at 10:55 p.m. in compliance of the provisions of the Companies Act, 2013:

**I. Submission of Response to Request for Proposal (RFP) – ‘Transmission system for evacuation of power from REZ In Rajasthan (20GW) under Phase-III Part B1’:-**

(i) **“Resolved that approval of the Board be and is hereby accorded for POWERGRID’s participation in the Tariff based competitive bidding for selection of Bidder as Transmission Service Provider (TSP) through tariff based competitive bidding process to establish Inter-State Transmission System for ‘Transmission system for evacuation of power from REZ In Rajasthan (20GW) under Phase-III Part B1’.”**

(ii) **“Resolved that pursuant to the provisions of the Companies Act, 2013 and compliance thereof and as permitted under the Memorandum and Articles of Association of the company, approval of the Board be and is hereby accorded for investment of 100 % (One Hundred per cent) of the total equity share capital of Bhadia III Transmission Limited representing the entire amount proposed to be invested by the company for the transmission system for “Transmission system for evacuation of power from REZ In Rajasthan (20GW) under Phase-III Part B1” , partly by acquisition of the existing equity shares from PFC Consulting Limited and/or partly by subscribing to the new equity shares, as per the terms of the RFP.”**

**“Resolved that Smt. Seema Gupta, Director (Operations)/ Shri V K Singh, Director (Personnel)/ Shri Mohammed Nawabkhan, Director (Finance)/ Shri**

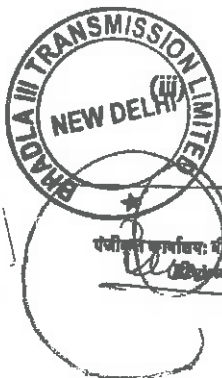

227

**डि. सुदर्शन  
D. SUDHARSHAN  
वरिष्ठ महासंचालक (वित्त)/Sr. General Manager (Finance)  
पावरग्रिड को.का./ POWERGRID, CC**

Abhay Choudhary, Director (Projects) – the whole time directors of the company, be and are hereby severally authorised to take all the steps required for submission of the Bid as per the RFP documents for selection of Bidder as Transmission Service Provider (TSP) through tariff based competitive bidding process to establish Inter-State Transmission System for "Transmission system for evacuation of power from REZ In Rajasthan (20GW) under Phase-III Part B1".

(iv) "Further Resolved that Shri A K Singhal, Executive Director / Shri B Vamsi Rama Mohan, Chief General Manager / Shri Dharanikota Sudharshan, Senior General Manager be and are hereby severally authorized to take all the steps required to be taken by the Company for submission of the Bid, including in particular, signing of the Bid, Bid Security Declaration, if any etc., making changes thereto and submitting amended Bid, all the documents related to the Bid, certified copy of this Board resolution or letter or undertakings etc, required to be submitted to BPC as part of the Bid or such other documents as may be necessary in this regard.

"Further Resolved that the Chairman & Managing Director/ Director (Operations)/ Director (Projects)/ Director (Personnel)/ Director (Finance) be and are hereby severally authorized to issue the Power of Attorney in this regard as per the format of the RFP documents for selection of Bidder as Transmission Service Provider (TSP) through tariff based competitive bidding process to establish Inter-State Transmission System for "Transmission system for evacuation of power from REZ In Rajasthan (20GW) under Phase-III Part B1" and the same be issued in line with Company policy and requirement of the RFP documents for Tariff based competitive bidding."

Certified to be true copy



**(Mrinal Shrivastava)**  
**Company Secretary**

मि. श्रीवास्तव, / MRINAL SHRIVASTAVA,  
कंपनी सचिव / Company Secretary  
पावर ग्रिड कॉर्पोरेशन ऑफ इंडिया लिमिटेड  
Power Grid Corporation of India Ltd  
(सरकार द्वारा उद्यम) / (A Govt. of India Enterprise)  
प्लॉट नं-2, सेक्टर-29, गुरुग्राम-122 001 (हरियाणा)  
Plot No.-2, Sector-29, Gurgaon-122 001 (Haryana)

*W/O*



केन्द्रीय कार्यालय: "सौदागिनी", प्लॉट नंबर 2, सेक्टर -29, गुरुग्राम -122001, (हरियाणा) टेलीफोन: 0124-2571700-719  
Corporate Office: "Sandamini", Plot No. 2, Sector-29, Gurugram-122001, (Haryana) Tel: 0124-2571700-719  
पंजीकृत कार्यालय: बी -9, कुतब इंस्टीट्यूशनल एरिया, कटवारिया सराई, नई दिल्ली -110 016. दूरभाष: 011-26560112, 26560121, 26560122, 26560123, 26560124, 26560125, 26560126, 26560127, 26560128, 26560129, 26560130, 26560131, 26560132, 26560133, 26560134, 26560135, 26560136, 26560137, 26560138, 26560139, 26560140, 26560141, 26560142, 26560143, 26560144, 26560145, 26560146, 26560147, 26560148, 26560149, 26560150, 26560151, 26560152, 26560153, 26560154, 26560155, 26560156, 26560157, 26560158, 26560159, 26560160, 26560161, 26560162, 26560163, 26560164, 26560165, 26560166, 26560167, 26560168, 26560169, 26560170, 26560171, 26560172, 26560173, 26560174, 26560175, 26560176, 26560177, 26560178, 26560179, 26560180, 26560181, 26560182, 26560183, 26560184, 26560185, 26560186, 26560187, 26560188, 26560189, 26560190, 26560191, 26560192, 26560193, 26560194, 26560195, 26560196, 26560197, 26560198, 26560199, 26560200, 26560201, 26560202, 26560203, 26560204, 26560205, 26560206, 26560207, 26560208, 26560209, 26560210, 26560211, 26560212, 26560213, 26560214, 26560215, 26560216, 26560217, 26560218, 26560219, 26560220, 26560221, 26560222, 26560223, 26560224, 26560225, 26560226, 26560227, 26560228, 26560229, 26560230, 26560231, 26560232, 26560233, 26560234, 26560235, 26560236, 26560237, 26560238, 26560239, 26560240, 26560241, 26560242, 26560243, 26560244, 26560245, 26560246, 26560247, 26560248, 26560249, 26560250, 26560251, 26560252, 26560253, 26560254, 26560255, 26560256, 26560257, 26560258, 26560259, 26560260, 26560261, 26560262, 26560263, 26560264, 26560265, 26560266, 26560267, 26560268, 26560269, 26560270, 26560271, 26560272, 26560273, 26560274, 26560275, 26560276, 26560277, 26560278, 26560279, 26560280, 26560281, 26560282, 26560283, 26560284, 26560285, 26560286, 26560287, 26560288, 26560289, 26560290, 26560291, 26560292, 26560293, 26560294, 26560295, 26560296, 26560297, 26560298, 26560299, 26560300, 26560301, 26560302, 26560303, 26560304, 26560305, 26560306, 26560307, 26560308, 26560309, 26560310, 26560311, 26560312, 26560313, 26560314, 26560315, 26560316, 26560317, 26560318, 26560319, 26560320, 26560321, 26560322, 26560323, 26560324, 26560325, 26560326, 26560327, 26560328, 26560329, 26560330, 26560331, 26560332, 26560333, 26560334, 26560335, 26560336, 26560337, 26560338, 26560339, 26560340, 26560341, 26560342, 26560343, 26560344, 26560345, 26560346, 26560347, 26560348, 26560349, 26560350, 26560351, 26560352, 26560353, 26560354, 26560355, 26560356, 26560357, 26560358, 26560359, 26560360, 26560361, 26560362, 26560363, 26560364, 26560365, 26560366, 26560367, 26560368, 26560369, 26560370, 26560371, 26560372, 26560373, 26560374, 26560375, 26560376, 26560377, 26560378, 26560379, 26560380, 26560381, 26560382, 26560383, 26560384, 26560385, 26560386, 26560387, 26560388, 26560389, 26560390, 26560391, 26560392, 26560393, 26560394, 26560395, 26560396, 26560397, 26560398, 26560399, 26560400, 26560401, 26560402, 26560403, 26560404, 26560405, 26560406, 26560407, 26560408, 26560409, 26560410, 26560411, 26560412, 26560413, 26560414, 26560415, 26560416, 26560417, 26560418, 26560419, 26560420, 26560421, 26560422, 26560423, 26560424, 26560425, 26560426, 26560427, 26560428, 26560429, 26560430, 26560431, 26560432, 26560433, 26560434, 26560435, 26560436, 26560437, 26560438, 26560439, 26560440, 26560441, 26560442, 26560443, 26560444, 26560445, 26560446, 26560447, 26560448, 26560449, 26560450, 26560451, 26560452, 26560453, 26560454, 26560455, 26560456, 26560457, 26560458, 26560459, 26560460, 26560461, 26560462, 26560463, 26560464, 26560465, 26560466, 26560467, 26560468, 26560469, 26560470, 26560471, 26560472, 26560473, 26560474, 26560475, 26560476, 26560477, 26560478, 26560479, 26560480, 26560481, 26560482, 26560483, 26560484, 26560485, 26560486, 26560487, 26560488, 26560489, 26560490, 26560491, 26560492, 26560493, 26560494, 26560495, 26560496, 26560497, 26560498, 26560499, 26560500, 26560501, 26560502, 26560503, 26560504, 26560505, 26560506, 26560507, 26560508, 26560509, 26560510, 26560511, 26560512, 26560513, 26560514, 26560515, 26560516, 26560517, 26560518, 26560519, 26560520, 26560521, 26560522, 26560523, 26560524, 26560525, 26560526, 26560527, 26560528, 26560529, 26560530, 26560531, 26560532, 26560533, 26560534, 26560535, 26560536, 26560537, 26560538, 26560539, 26560540, 26560541, 26560542, 26560543, 26560544, 26560545, 26560546, 26560547, 26560548, 26560549, 26560550, 26560551, 26560552, 26560553, 26560554, 26560555, 26560556, 26560557, 26560558, 26560559, 26560560, 26560561, 26560562, 26560563, 26560564, 26560565, 26560566, 26560567, 26560568, 26560569, 26560570, 26560571, 26560572, 26560573, 26560574, 26560575, 26560576, 26560577, 26560578, 26560579, 26560580, 26560581, 26560582, 26560583, 26560584, 26560585, 26560586, 26560587, 26560588, 26560589, 26560590, 26560591, 26560592, 26560593, 26560594, 26560595, 26560596, 26560597, 26560598, 26560599, 26560600, 26560601, 26560602, 26560603, 26560604, 26560605, 26560606, 26560607, 26560608, 26560609, 26560610, 26560611, 26560612, 26560613, 26560614, 26560615, 26560616, 26560617, 26560618, 26560619, 26560620, 26560621, 26560622, 26560623, 26560624, 26560625, 26560626, 26560627, 26560628, 26560629, 26560630, 26560631, 26560632, 26560633, 26560634, 26560635, 26560636, 26560637, 26560638, 26560639, 26560640, 26560641, 26560642, 26560643, 26560644, 26560645, 26560646, 26560647, 26560648, 26560649, 26560650, 26560651, 26560652, 26560653, 26560654, 26560655, 26560656, 26560657, 26560658, 26560659, 26560660, 26560661, 26560662, 26560663, 26560664, 26560665, 26560666, 26560667, 26560668, 26560669, 26560670, 26560671, 26560672, 26560673, 26560674, 26560675, 26560676, 26560677, 26560678, 26560679, 26560680, 26560681, 26560682, 26560683, 26560684, 26560685, 26560686, 26560687, 26560688, 26560689, 26560690, 26560691, 26560692, 26560693, 26560694, 26560695, 26560696, 26560697, 26560698, 26560699, 26560700, 26560701, 26560702, 26560703, 26560704, 26560705, 26560706, 26560707, 26560708, 26560709, 26560710, 26560711, 26560712, 26560713, 26560714, 26560715, 26560716, 26560717, 26560718, 26560719, 26560720, 26560721, 26560722, 26560723, 26560724, 26560725, 26560726, 26560727, 26560728, 26560729, 26560730, 26560731, 26560732, 26560733, 26560734, 26560735, 26560736, 26560737, 26560738, 26560739, 26560740, 26560741, 26560742, 26560743, 26560744, 26560745, 26560746, 26560747, 26560748, 26560749, 26560750, 26560751, 26560752, 26560753, 26560754, 26560755, 26560756, 26560757, 26560758, 26560759, 26560760, 26560761, 26560762, 26560763, 26560764, 26560765, 26560766, 26560767, 26560768, 26560769, 26560770, 26560771, 26560772, 26560773, 26560774, 26560775, 26560776, 26560777, 26560778, 26560779, 26560780, 26560781, 26560782, 26560783, 26560784, 26560785, 26560786, 26560787, 26560788, 26560789, 26560790, 26560791, 26560792, 26560793, 26560794, 26560795, 26560796, 26560797, 26560798, 26560799, 26560800, 26560801, 26560802, 26560803, 26560804, 26560805, 26560806, 26560807, 26560808, 26560809, 26560810, 26560811, 26560812, 26560813, 26560814, 26560815, 26560816, 26560817, 26560818, 26560819, 26560820, 26560821, 26560822, 26560823, 26560824, 26560825, 26560826, 26560827, 26560828, 26560829, 26560830, 26560831, 26560832, 26560833, 26560834, 26560835, 26560836, 26560837, 26560838, 26560839, 26560840, 26560841, 26560842, 26560843, 26560844, 26560845, 26560846, 26560847, 26560848, 26560849, 26560850, 26560851, 26560852, 26560853, 26560854, 26560855, 26560856, 26560857, 26560858, 26560859, 26560860, 26560861, 26560862, 26560863, 26560864, 26560865, 26560866, 26560867, 26560868, 26560869, 26560870, 26560871, 26560872, 26560873, 26560874, 26560875, 26560876, 26560877, 26560878, 26560879, 26560880, 26560881, 26560882, 26560883, 26560884, 26560885, 26560886, 26560887, 26560888, 26560889, 26560890, 26560891, 26560892, 26560893, 26560894, 26560895, 26560896, 26560897, 26560898, 26560899, 26560900, 26560901, 26560902, 26560903, 26560904, 26560905, 26560906, 26560907, 26560908, 26560909, 26560910, 26560911, 26560912, 26560913, 26560914, 26560915, 26560916, 26560917, 26560918, 26560919, 26560920, 26560921, 26560922, 26560923, 26560924, 26560925, 26560926, 26560927, 26560928, 26560929, 26560930, 26560931, 26560932, 26560933, 26560934, 26560935, 26560936, 26560937, 26560938, 26560939, 26560940, 26560941, 26560942, 26560943, 26560944, 26560945, 26560946, 26560947, 26560948, 26560949, 26560950, 26560951, 26560952, 26560953, 26560954, 26560955, 26560956, 26560957, 26560958, 26560959, 26560960, 26560961, 26560962, 26560963, 26560964, 26560965, 26560966, 26560967, 26560968, 26560969, 26560970, 26560971, 26560972, 26560973, 26560974, 26560975, 26560976, 26560977, 26560978, 26560979, 26560980, 26560981, 26560982, 26560983, 26560984, 26560985, 26560986, 26560987, 26560988, 26560989, 26560990, 26560991, 26560992, 26560993, 26560994, 26560995, 26560996, 26560997, 26560998, 26560999, 26561000, 26561001, 26561002, 26561003, 26561004, 26561005, 26561006, 26561007, 26561008, 26561009, 26561010, 26561011, 26561012, 26561013, 26561014, 26561015, 26561016, 26561017, 26561018, 26561019, 26561020, 26561021, 26561022, 26561023, 26561024, 26561025, 26561026, 26561027, 26561028, 26561029, 26561030, 26561031, 26561032, 26561033, 26561034, 26561035, 26561036, 26561037, 26561038, 26561039, 26561040, 26561041, 26561042, 26561043, 26561044, 26561045, 26561046, 26561047, 26561048, 26561049, 26561050, 26561051, 26561052, 26561053, 26561054, 26561055, 26561056, 26561057, 26561058, 26561059, 26561060, 26561061, 26561062, 26561063, 26561064, 26561065, 26561066, 26561067, 26561068, 26561069, 26561070, 26561071, 26561072, 26561073, 26561074, 26561075, 26561076, 26561077, 26561078, 26561079, 26561080, 26561081, 26561082, 26561083, 26561084, 26561085, 26561086, 26561087, 26561088, 26561089, 26561090, 26561091, 26561092, 26561093, 26561094, 26561095, 26561096, 26561097, 26561098, 26561099, 26561100, 26561101, 26561102, 26561103, 26561104, 26561105, 26561106, 26561107, 26561108, 26561109, 26561110, 26561111, 26561112, 26561113, 26561114, 26561115, 26561116, 26561117, 26561118, 26561119, 26561120, 26561121, 26561122, 26561123, 26561124, 26561125, 26561126, 26561127, 26561128, 26561129, 26561130, 26561131, 26561132, 26561133, 26561134, 26561135, 26561136, 26561137, 26561138, 26561139, 26561140, 26561141, 26561142, 26561143, 26561144, 26561145, 26561146, 26561147, 26561148, 26561149, 26561150, 26561151, 26561152, 26561153, 26561154, 26561155, 26561156, 26561157, 26561158, 26561159, 26561160, 26561161, 26561162, 26561163, 26561164, 26561165, 26561166, 26561167, 26561168, 26561169, 26561170, 26561171, 26561172, 26561173, 26561174, 26561175, 26561176, 26561177, 26561178, 26561179, 26561180, 26561181, 26561182, 26561183, 26561184, 26561185, 26561186, 26561187, 26561188, 26561189, 26561190, 26561191, 26561192, 26561193, 26561194, 26561195, 26561196, 26561197, 26561198, 26561199, 26561200, 26561201, 26561202, 26561203, 26561204, 26561205, 26561206, 26561207, 26561208, 26561209, 26561210, 26561211, 26561212, 26561213, 26561214, 26561215, 26561216, 26561217, 26561



## BIDDER'S COMPOSITION AND OWNERSHIP STRUCTURE

### 1. Corporate Details:

#### a. Company's Name, Address, and Nationality:

Name: **Power Grid Corporation of India Limited**

Address: Registered Office:  
B-9, Qutab Institutional Area, Katwaria Sarai,  
New Delhi-110016

Website address: <https://www.powergrid.in>

Country of Origin: India

b. Year Organized: 1989

#### c. Company's Business Activities:

POWERGRID undertakes implementation of inter-state transmission system on Build, Own, Operate and Maintain (BOOM) basis. The transmission projects undertaken can be broadly classified as: (i) Generation Linked Projects, (ii) Grid Strengthening Projects, (iii) Inter-regional links and (iv) Unified Load Dispatch & Communication schemes, inter-alia including survey, Detailed project report formulation, Arranging Finance, Project Management, obtaining necessary consents/approvals, Clearances and Permits, Design, Engineering, Procurement of Equipment/Material, Construction, Erection, Testing, Commissioning.

POWERGRID has established a wide telecom network and has provided connectivity to metros, major cities & towns in the country.

POWERGRID is offering consultancy in the field of Planning, Engineering, Load Dispatch and Communication, Telecommunication, Contracting, Financial and Project Management both in India and overseas. POWERGRID is also assisting various State Power utilities in the country for implementation of their transmission/sub-transmission projects.

#### d. Status as a Bidder:

1.  Bidding Company
2. ~~Lead Member of the Bidding Consortium~~
3. ~~Member of the Bidding Consortium~~

#### e. Company's Local Address in India:

Saudamini, Plot No. 2, Sector 29,  
Gurgaon - 122001 (Haryana)

डि. सुदर्शन  
D. SUDHARSHAN  
वरिष्ठ प्रशासक (वित्त)/Sr. General Manager (Finance)  
पावरग्रिड के.का. / POWERGRID, CC

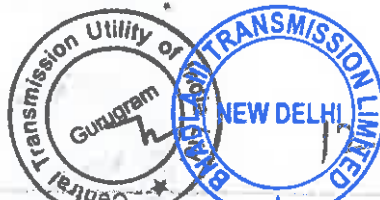

राष्ट्रीय कार्यालय : "सौदामिनी", प्लॉट नं. 2, सेक्टर 29, गुरुग्राम-122001, (हरियाणा), दूरभाष : 0124-2571700-719  
Corporate Office : "Saudamini", Plot No. 2, Sector-29, Gurugram-122001, (Haryana) Tel. : 0124-2571700-719

पंजीकृत कार्यालय : "सौदामिनी", प्लॉट नं. 2, सेक्टर 29, गुरुग्राम-122001, (हरियाणा), दूरभाष : 0124-2571700-719  
Registered Office : B-9, Qutab Institutional Area, Katwaria Sarai, New Delhi-110016. Tel.: 011-26560112, 26564812, 26564812, 26564892, सीआइएन : L40101DL1989GOI038121  
Website : www.powergridindia.com

f. Name of the Authorised Signatory: D Sudharshan

g. Telephone Number: 0124-2822093 , Mob: 9449599097

h. Email Address: [achoudhary@powergrid.in](mailto:achoudhary@powergrid.in); [tbc@powergrid.co.in](mailto:tbc@powergrid.co.in),  
[ppandey@powergrid.in](mailto:ppandey@powergrid.in) , [sudarshan@powergrid.in](mailto:sudarshan@powergrid.in)

i. Telefax Number: 0124 2571802

j. Documents attached:

**Attachment - 1:**

Certified Copies (including amendments) of:

- i. Memorandum of Association
- ii. Articles of Association
- iii. Certificate of incorporation

**Attachment - 2:**

- i. Authorization in favour of BPC as per Clause 2.1.6 of the RFP.



  
डि. सुदर्शन  
D. SUDHARSHAN  
जीएनएल (फिन)/जी. जनरल मैनेजर (फिन्स)  
वायलिनक को.एम./ POWERGRID, CC

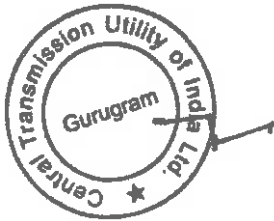





13/  
220





2. Details of Ownership Structure:

Equity holding of Bidding Company owning 10% or more of total paid up equity.

Name of the Bidding Company: Power Grid Corporation of India Limited  
Status of equity holding as on ... 01/06/2023..

Name of the Equity Holder	Type and No. of Shares owned	Extent of Voting Control (%)
1. Government of India	Equity, 3581163210	51.34%
2. Public	Equity, 3394289654	48.66%

For and on behalf of Bidding Company  
M/s Power Grid Corporation of India Limited

.....  
(Signature of authorized representative)

Name: D Sudharshan

Designation: Senior General Manager  
डी. सुदर्शन  
D. SUDHARSHAN  
सीनियर जनरल मैनेजर (फिनेंस) / Sr. General Manager (Finance)  
पावरग्रिड को.क./ POWERGRID, CC



Date: .... 19/06/2023 .....

Place: Gurgaon

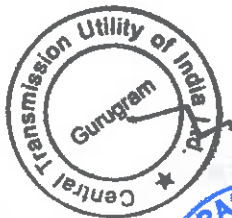

210

14

231

राष्ट्रीय कार्यालय : "सौदामिनी" प्लॉट नं. 2, सेक्टर-29, गुरुग्राम-122001 (हरियाणा), दूरभाष 0124-2822000, 2823000  
Corporate Office : "Saudamini", Plot No. 2, Sector-29, Gurugram-122001, (Haryana) Tel. : 0124-2822000, 2823000

पंजीकृत कार्यालय : ई-8, कुतुब इंस्टीट्यूशनल एरिया, कटवारिया सराय, नई दिल्ली-110016 011-26580112, 26564812, 26584892, सीआईएन : L40101DL1969GOI038121  
Registered Office : B-8, Qutab Institution Area, Katwaris Sarai, New Delhi-110016. Tel.: 011-26580112, 26564812, 26584892, CIN : L40101DL1969GOI038121  
Website : www.powergrid.in



**Attachment – 1**  
**to**  
**Format for Bidder's Composition and**  
**Ownership Structure**

Certified copies of

- (i) Memorandum of Association
- (ii) Article of Association
- (iii) Certificate of Incorporation

} Enclosed at the end



↖ ↗  
**डि. सुदर्शन**  
**D. SUDHARSHAN**  
वरिष्ठ वित्त प्रबंधक (वित्त) / Sr. General Manager (Finance)  
पावरग्रिड को.सं. / POWERGRID, CC



2010..

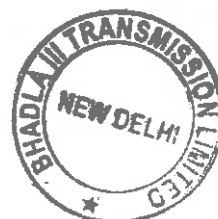



**Attachment – 2**  
**to**  
**Format for Bidder's Composition and**  
**Ownership Structure**

**(Authorisation)**



  
**डि. सुदर्शन**  
**D. SUDHARSHAN**  
जीनरल मैनेजर (फिन्स) डि. General Manager (Finance)  
पावरग्रिड को.कॉ. / POWERGRID, CC

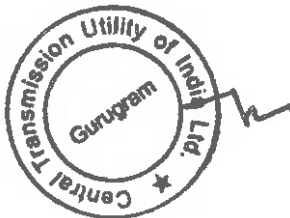

220.



16

223

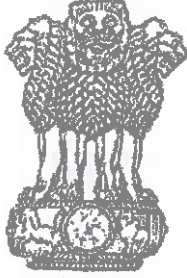

सत्यमेव जयते

INDIA NON JUDICIAL

Government of National Capital Territory of Delhi

e-Stamp

Certificate No.	: IN-DL44208435049402V
Certificate Issued Date	: 09-Jan-2023 11:25 AM
Account Reference	: IMPACC (IV) dl974203/ DELHI/ DL-DLH
Unique Doc. Reference	: SUBIN-DL DL97420362227639288981V
Purchased by	: POWER GRID CORPORATION OF INDIA LIMITED
Description of Document	Article Others
Property Description	Not Applicable
Consideration Price (Rs.)	0 (Zero)
First Party	POWER GRID CORPORATION OF INDIA LIMITED
Second Party	Not Applicable
Stamp Duty Paid By	: POWER GRID CORPORATION OF INDIA LIMITED
Stamp Duty Amount(Rs.)	: 100 (One Hundred only)

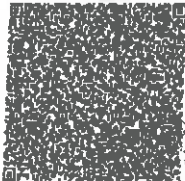

Please verify on the website

AUTHORISATION

The undersigned hereby authorize(s) and request(s) all our Bankers, including its subsidiaries and branches, any person, firm, corporation or authority to furnish pertinent information deemed necessary and requested by PFC Consulting Limited to verify our Bid for selection



Handwritten signature

234 डी. सुदर्शन D. SUDHARSHAN

Statutory Alert: 1. The authenticity of the Stamp certificate should be verified at www.indianstamp.com using e-Stamping Machine (ESM) or Competent Authority (Finance) Any discrepancy in the details on this Certificate and as available on the website / Mobile App should be reported to the Competent Authority. 2. The onus of checking the legitimacy is on the users of the certificate. 3. In case of any discrepancy, please inform the Competent Authority.

of Bidder as Transmission Service Provider to establish Inter-State Transmission system for "Transmission system for evacuation of power from REZ in Rajasthan (20GW) under Phase-III Part B1" through tariff based competitive bidding process or regarding our project development experience, financial standing and general reputation.

For and on behalf of M/s Power Grid Corporation of India Limited

  
.....  
(Signature)

डि. सुदर्शन  
D. SUDHARSHAN  
वरिष्ठ वित्त अधिकारी (सीएम)/Sr. General Manager (Finance)  
पावरग्रिड को. लि. / POWERGRID, CC

Name of Authorised Signatory: D. Sudharshan

Place: New Delhi

Date: 02/02/23



ATTESTED  
NOTARY PUBLIC  
NEW DELHI. (INDIA)

.....  
(Signature of Notary Public)

Place: New Delhi

Date: 02/02/23

715 7023

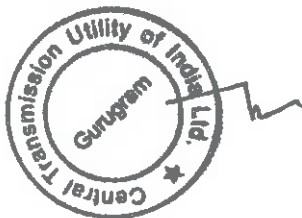

210..

18

235



**QUALIFICATION REQUIREMENT**

**NET WORTH**

To,

**PFC Consulting Limited**  
9th Floor, Wing-A, Statesman House,  
Connaught Place, New Delhi - 110001

Dear Sir,

**Sub: Bid for selection of Bidder as Transmission Service Provider to establish Inter-State Transmission System for "Transmission system for evacuation of power from REZ in Rajasthan (20GW) under Phase-III Part B1" through tariff based competitive bidding process.**

We certify that the M/s Power Grid Corporation of India Limited had a Networth of Rs. 74,563.91 Crore computed as per instructions in this RFP in the financial year 2021-22 based on unconsolidated audited annual accounts of any of the last three (3) financial years as provided in Clause 2.2.3, immediately preceding the Bid Deadline. Also, the Networth of any of the last three (3) financial years is not negative.

Name of Financially Evaluated Entity(ies)	Relationship with Bidding Company	Financial Year	Networth (Rs. Crore)
Power Grid Corporation of India Limited		2021-22	74,563.91 (as on 31.03.2022)
<b>Total Networth</b>			<b>74,563.91</b>

Yours faithfully

  
**डि. सुदर्शन**  
**D. SUDHARSHAN**  
 चरिटेड अकाउंटन्ट्स (फिन्स) / Sr. General Manager (Finance)  
 पावर ग्रिड कॉर्पोरेशन ऑफ इंडिया लिमिटेड / POWER GRID CORPORATION OF INDIA LIMITED  
 (Signature and name of the authorized signatory of the Company and Stamp)

Name: D Sudharshan  
 Date: 20/01/2023  
 Place: Gurugram

.....  
 (Signature and Stamp of statutory Auditors of Bidding Company)

Name: R Balasubramanian  
 Date: 20/01/2023  
 Place: New Delhi

Date: 20 JAN 2023

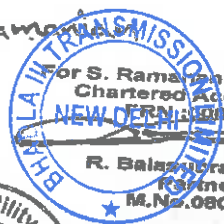
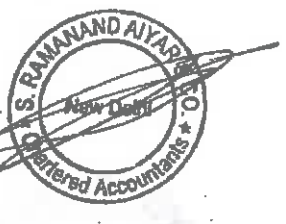
  
 For S. Ramani and Aiyar & Co.  
 Chartered Accountants  
 NEW DELHI-110090N  
 R. Balasubramanian  
 Partner  
 M.No.080432  

केन्द्रीय कार्यालय : "साउथमिन" ब्लॉक सं. 2, सेक्टर-28, गुरुग्राम-122001, (हरियाणा) दूरभाष : 0124-2571700-719  
 Corporate Office : "Saudamin", Plot No. 2, Sector-28, Gurugram-122001, (Haryana) Tel. : 0124-2571700-719

236



**पावरग्रिड  
POWERGRID**

पावर ग्रिड कॉर्पोरेशन ऑफ इंडिया लिमिटेड

(भारत सरकार का उद्यम)

**POWER GRID CORPORATION OF INDIA LIMITED**

(A Government of India Enterprise)

**TECHNICAL REQUIREMENT**

To,

**PFC Consulting Limited**  
9<sup>th</sup> Floor, Wing-A, Statesman House,  
Connaught Place, New Delhi - 110001.

Dear Sir,

**Sub: Bid for selection of Bidder as Transmission Service Provider to establish Inter-State Transmission System for "Transmission system for evacuation of power from REZ in Rajasthan (20GW) under Phase-III Part B1" through tariff based competitive bidding process.**

We certify that M/s. Power Grid Corporation of India Limited have experience of development of projects in the Infrastructure sector in the last five (5) years whose aggregate capital expenditure is more than Rs. 2000 Crore. We further certify that the capital expenditure of any single project considered for meeting the technical Qualification Requirement is not less than Rs. 400 Crore. For this purpose, capital expenditure incurred on projects which have been either wholly completed/ commissioned or partly completed projects put under commercial operation and for which operation has commenced till at least seven (7) days prior to the Bid Deadline has been considered.

The project(s) considered for the purpose of technical experience (as per table given below) have been executed and owned to the extent as indicated in the table below by the Bidding Company on operation of the projects.

This technical requirement has been calculated as per the instructions provided in the RFP on the basis of following projects:

Name of Company (which has executed the project at (3)) whose technical capability has been used for Qualification Requirement	Relation ship with Bidding Company / Lead Member	Project name	Nature of Project (BOOT, BOT, BOOM, DBFOT etc.)	Relevant Infrastructure Sector	Date of Financial Closure of the Project (In DD / MM / YYYY)	Date of Completion / Commissioning / Commercial Operation of partly completed projects*	Project cost (Rs. Crore)*	Percentage Equity Holding of Company at (1) in Completed project(s) \$
(1)	(2)	(3)	(4)	(5)	(6)	(7)	(8)	(9)
Power Grid Corporation of India Limited		HVDC Bipole link between Western Region (Raigarh, Chattisgarh) and Southern Region (Pugalur, Tamil Nadu)-North Trichur (Kerala)-Scheme I: Raigarh-Pugalur 6000MW HVDC System	BOOM	Inter-state Transmission project	05/05/2016	25/10/2021	13025.56	100%

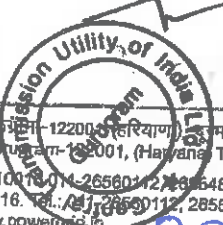
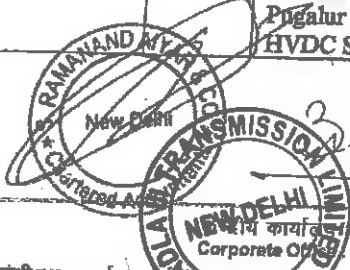

डि. सुदर्शन  
D. SUDHARSHAN

पंजीकृत कार्यालय : सौदामिनी ब्लॉक नं. 2, सेक्टर-29, गुडतबलन-110016 (हरियाणा)। पता : प्लॉट नं. 2000, गुडतबलन-110016, गुडतबलन एरिया, कटवारिया सराय, नई दिल्ली-110016. फोन : 26560112, 26564812, 26564892, सीआरएन : L40101DL1989GOI038121  
Registered Office : गुडतबलन एरिया, कटवारिया सराय, नई दिल्ली-110016. फोन : 26560112, 26564812, 26564892, सीआरएन : L40101DL1989GOI038121  
Website : www.powergrid.in

237

Name of Company (which has executed the project at (3)) whose technical capability has been used for Qualification Requirement	Relationship with Bidding Company / Lead Member	Project name	Nature of Project (BOOT, BOT, BOOM, DBFOT etc.)	Relevant Infrastructure Sector	Date of Financial Closure of the Project (In DD / MM / YYYY)	Date of Completion / Commissioning / Commercial Operation of partly completed projects*	Project cost (Rs. Crore) <sup>†</sup>	Percentage Equity Holding of Company at (1) in Completed project(s) §	
(1)	(2)	(3)	(4)	(5)	(6)	(7)	(8)	(9)	
Power Grid Corporation of India Limited		HVDC Bipole link between Western Region (Raigarh, Chattisgarh) and Southern Region (Pugalur, Tamil Nadu) – North Trichur (Kerala) – Scheme#2: AC System Strengthening at Pugalur end	BOOM	Inter-state Transmission project	16/08/2017	25/10/2021	2222.75	100%	
Power Grid Corporation of India Limited		HVDC Bipole link between Western Region (Raigarh, Chattisgarh) and Southern Region (Pugalur, Tamil Nadu)-North Trichur (Kerala)- Scheme#3: Pugalur-Trichur 2000 MW VSC based HVDC system	BOOM	Inter-state Transmission project	09/02/2017	08/06/2021	4620.47	100%	
Power Grid Corporation of India Limited		Additional ATS for Tumkur (Pavagada) [Transmission System for Ultra Mega Solar Park at Tumkur (Pavagada), Karnataka-Phase II (Part-B)]	BOOM	Inter-state Transmission project	29/05/2017	01/03/2021	515.45	100%	
<b>Total (Rs. Crore)</b>							<b>20384.23</b>		

\* Date of Commercial Operation

†Project Cost as on Date of Commercial Operation

§ The Projects have been executed by POWERGRID itself. The project cost is 100% funded by POWERGRID through debt and equity.

Note: The aggregate capital expenditure of Power Grid Corporation of India Limited in the last 5 financial years is more than Rs.40000 Crore as can be seen from the Balance Sheets. A number of projects have been executed by POWERGRID whose capital expenditure is more than Rs. 400 Crore, out of which 4 have been listed above.

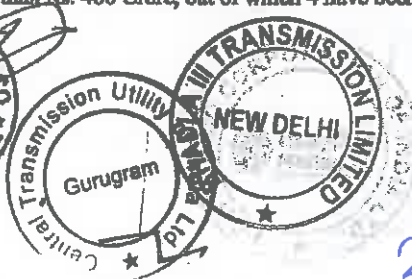
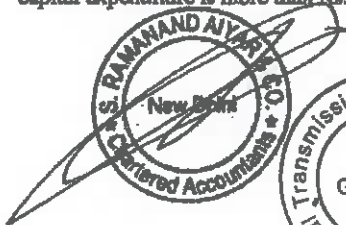

3/10

*(Signature)*

डि. सुदर्शन  
D. SUDHARSHAN

वरिष्ठ महाप्रबंधक (वित्त) / Sr. General Manager (Finance)  
पावरग्रिड के.एन. / POWERGRID, CC

238



We further certify that the Company(ies) as indicated in column (1) of the above table, whose technical capability has been used for meeting the qualification requirement, has held shareholding respectively of atleast twenty – six percent (26%) from the date of financial closure till the date of commissioning / completion of the above project(s)

Yours faithfully



डि. सुदर्शन

D. SUDHARSHAN

रजिस्टर्ड मैनेजर (फिन)/Sr. General Manager (Finance)

POWERGRID, CO

(Signature and name of the authorized signatory of the Company and stamp)

Name: D Sudharshan

Date: 12/6/23

Place: Gurgaon

For S. Ramasund Aiyar & Co.  
Chartered Accountants  
FRN :000990N



R. Balasubramanian  
Partner

M.No.:91042/...

(Signature and Stamp of statutory Auditors of Bidding Company)

Name: R Balasubramanian

Date: 12/6/23

Place: New Delhi



Date: 12/6/23

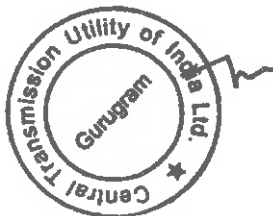



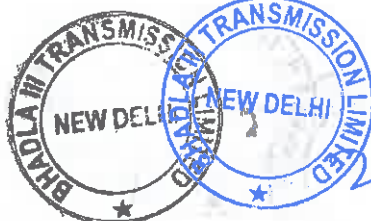

29

**Attachment**  
**to**  
**Format for**  
**Qualification Requirement**  
**(A. Networth)**  
**&**  
**(B. Technical Requirement)**

1. Computation of Networth duly certified by Statutory Auditor
2. Computation of Capital Expenditure of projects duly certified by Statutory Auditor



  
**डि. सुदर्शन**  
**D. SUDHARSHAN**  
वरिष्ठ प्रबन्धक (वित्त) / Sr. General Manager (Finance)  
शुभचिन्त कं.का. / POWERGRID, CC

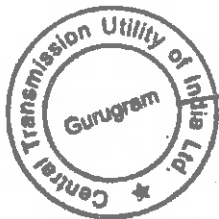

Dtd..

23

240

**S. Ramanand Aiyar & Co.**  
CHARTERED ACCOUNTANTS

708, 605 SURYA KIRAN 19 KASTURBA GANDHI MARG NEW DELHI 110 001  
Tels : 91 11 2331 9284 2335 2721 4151 0045  
sriaiyar@yahoo.com, bala@sraco.in  
www.sraco.in

SRA-RB/2022-2023/212

**CERTIFICATE**

To,  
The Power Grid Corporation of India Limited  
B-9, Qutab Institutional Area, Katwaria Sarai,  
New Delhi-110016

**Independent Statutory Auditor's Certificate on net worth and capital cost of specific projects for Request for Proposal (RFP) dated 4<sup>th</sup> February 2022 issued by PFC Consulting Limited**

We understand that Power Grid Corporation of India Limited ("the Company") having its registered office at B-9, Qutab Institutional Area, Katwaria Sarai, New Delhi - 110 016 is required to obtain a certificate with respect to Net Worth as at 31<sup>st</sup> March 2022, 31<sup>st</sup> March 2021, 31<sup>st</sup> March 2020 and capital cost of specific projects for the purpose of submission with PFC Consulting Limited with respect to their RFP dated 4<sup>th</sup> February 2022 for selection of Transmission Service Provider (TSP) to establish Inter-State transmission system for "Transmission system for evacuation of power from REZ in Rajasthan (20GW) under Phase-III Part B1".

**Management's Responsibility**

The Company's Management is responsible for the preparation and maintenance of all accounting and other relevant supporting records and documents. This responsibility includes the design, implementation and maintenance of internal control relevant to the preparation and maintenance of the records with respect to the net worth of the Company as on 31<sup>st</sup> March 2022, 31<sup>st</sup> March 2021, 31<sup>st</sup> March 2020 and capital cost of specific projects.

**Auditor's Responsibility**

Our responsibility is to provide reasonable assurance with respect to net worth of the Company as at 31<sup>st</sup> March 2022, 31<sup>st</sup> March 2021, 31<sup>st</sup> March 2020 and capital cost of the specific projects.

We conducted our examination in accordance with the Guidance Note on Reports or Certificates for Special Purposes issued by the Institute of Chartered Accountants of India. The Guidance Note requires that we comply with the ethical requirements of the Code of Ethics issued by the Institute of Chartered Accountants of India.

We have complied with the relevant applicable requirements of the Standard on Quality Control (SQ) 1, Quality Control for Firms that Perform Audits and Reviews of Historical Financial Information and Other Assurance and Related Services Engagements.

**Opinion**

Based on the audited financial statements for the year ended 31<sup>st</sup> March 2022, 31<sup>st</sup> March 2021, 31<sup>st</sup> March 2020 and the further information and explanations given to us, we hereby certify that the net worth of the Company as at 31<sup>st</sup> March 2022, 31<sup>st</sup> March 2021, 31<sup>st</sup> March 2020 computed in accordance with Clause 2.1.3.2 of RFP dated 4<sup>th</sup> February 2022 issued by PFC Consulting Limited, is Rs. 74,563.91 Crore, Rs. 67,952.54 Crore and Rs. 62,722.73 Crore respectively. (refer Annexure A enclosed).

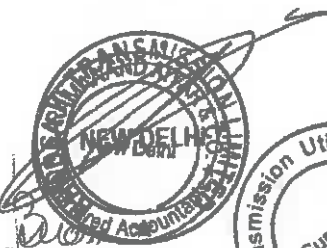

डि. सुदर्शन  
D. SUDHARSHAN  
सर्वोपचारक (वित्त) / Sr. General Manager (Finance)  
शक्ति विद्युत को. लि. / POWERGRID, CC

241  
Offices also at  
Mumbai Kolkata Indore Gurugram  
Ernakulam Ahmedabad Bengaluru Hyderabad

## Annexure -A

Calculation of Net Worth of Power Grid Corporation of India Limited as at 31<sup>st</sup> March 2022, 31<sup>st</sup> March 2021 and 31<sup>st</sup> March 2020 as per Clause 2.1.3.2 of RFP dated 4<sup>th</sup> February 2022 issued by PFC Consulting Limited is given below:

(Rs. In Crore)

Particulars	As at 31 <sup>st</sup> March 2022	As at 31 <sup>st</sup> March 2021	As at 31 <sup>st</sup> March 2020
Equity Share Capital	6,975.45	5,231.59	5,231.59
Add: Reserves	69,176.12	64,347.25	59,208.10
Less:			
Revaluation Reserves	-	-	-
Corporate Social Responsibility (CSR) Activity Reserve	-	-	-
Intangible assets (including intangible assets under development)	1,587.66	1,626.30	1,716.96
Miscellaneous expenditure to the extent not written off and carry forward losses	-	-	-
Net Worth	74,563.91	67,952.54	62,722.73

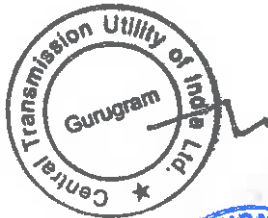

  
 दि. सुदर्शन  
 D. SUDHARSHAN  
 वरिष्ठ वित्तशास्त्रज्ञ (वित्त)/Sr. General Manager (Finance)  
 पावरग्रिड के.ए.। POWERGRID, CC

242

Further on the basis of books of accounts and the further information and explanations given to us, we hereby certify that the capital cost as per CERC Regulations and date of commercial operation for the following projects are as under:

Sl. No.	Particulars*	Date of Commercial Operation of Latest Element Capitalised in the Project (DOCO)	Rs. in Crore
			Total Project Cost as on DOCO
1	HVDC Bipole link between Western Region (Raigarh, Chattisgarh) and Southern Region (Pugalur, Tamil Nadu)-North Trichur (Kerala)-Scheme1: Raigarh-Pugalur 6000MW HVDC System	25-Oct-2021	13025.56
2	HVDC Bipole link between Western Region (Raigarh, Chattisgarh) and Southern Region (Pugalur, Tamil Nadu) - North Trichur (Kerala) - Scheme#2: AC System Strengthening at Pugalur end	25-Oct-2021	2222.75
3	HVDC Bipole link between Western Region (Raigarh, Chattisgarh) and Southern Region (Pugalur, Tamil Nadu)-North Trichur (Kerala)-Scheme#3: Pugalur-Trichur 2000 MW VSC based HVDC system	08-June-2021	4620.47
4	Additional ATS for Tumkur (Pavagada) [Transmission System for Ultra Mega Solar Park at Tumkur (Pavagada), Karnataka-Phase II (Part-B)]	01-March-2021	515.45
	<b>Total</b>		<b>20384.23</b>

\*Refer Annexure B enclosed

We also hereby certify that Capital Expenditure as mentioned above for respective Projects has been capitalized in the books of Accounts.

#### Restriction on Use

This certificate has been issued to the management of Power Grid Corporation of India Limited for the purpose of submission to PFC Consulting Limited. Our certificate should not to be used for any other purpose or by any person other than the addressees of this certificate. Accordingly, we do not accept or assume any liability or duty of care to any other person to whom this certificate is shown or into whose hands it may come save where expressly agreed by our prior consent in writing.

**For S. Ramanand Aiyar & Co.**

**Chartered Accountants**

Firm's Registration Number- 000990N

R. Balasubramanian

Partner

M. No. 080432

UDIN: 23080432BGWPCY3246

Place: Delhi

Date: 20-01-2023

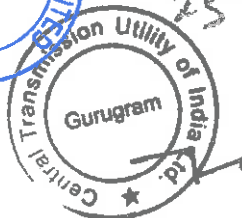
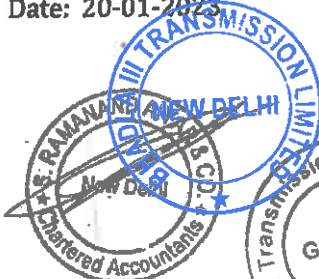

डि. सुदर्शन  
D. SUDHARSHAN  
वरिष्ठ वित्तप्रबंधक (वित्त)/Sr. General Manager (Finance)  
पावरग्रिड को.का. / POWERGRID, CC

Annexure B

Date of commercial operation of specific projects along with capital cost is detailed as under:

Sl.	Project name	Date of Commercial Operation of Latest Element Capitalised in the Project	Cost						Total Project Cost as on DOCO
			Land	Building and Civil Works	Transmission Line	Substation	PLCC	IT Equipment Including Software	
1	HVDC Bipole link between Western Region (Raigarh, Chattisgarh) and Southern Region (Pugalur, Tamil Nadu)-North Trichur (Kerala)-Scheme#1: Raigarh-Pugalur 6000MW HVDC System	25-Oct-2021	19.27	951.53	6,138.71	5,750.72	80.93	84.40	13,025.56
2	HVDC Bipole link between Western Region (Raigarh, Chattisgarh) and Southern Region (Pugalur, Tamil Nadu) - North Trichur (Kerala) - Scheme#2: AC System Strengthening at Pugalur end	25-Oct-2021	0.00	4.44	1,961.66	245.00	10.96	0.69	2,222.75
3	HVDC Bipole link between Western Region (Raigarh, Chattisgarh) and Southern Region (Pugalur, Tamil Nadu)-North Trichur (Kerala)-Scheme#3: Pugalur-Trichur 2000 MW VSC based HVDC system Additional ATS for Tumkur (Pavagada) [Transmission System for Ultra Mega Solar Park at Tumkur (Pavagada), Karnataka-Phase II (Part-B)]	08-June-2021 01-March-2021	35.10 0.00	219.13 0.00	1225.43 449.32	3112.51 57.81	3.20 6.48	25.10 1.84	4,620.47 515.45

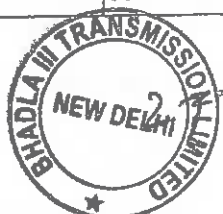
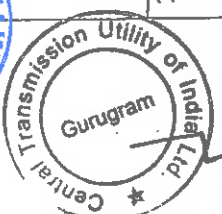

3 No.  
244



डि. सुदर्शन  
D. SUDHARSHAN  
वरिष्ठ प्रबंधक (फि)/Sr. General Manager (Finance)  
वायव्यीक केंद्र./ POWERGRID, CC



**Undertaking**

In pursuance to Clause 2.2.3, Information and Instructions for Bidders, Request for Proposal Document for selection of Bidder as Transmission Service Provider through tariff based competitive bidding process to establish Inter-State Transmission System for "Transmission system for evacuation of power from REZ in Rajasthan (20GW) under Phase-III Part B1", it is stated that the annual accounts of M/s. Power Grid Corporation of India Limited having its registered office at B-9, Qutab Institutional Areas, Katwaria Sarai, New Delhi -110 016 for the Financial Year 2022-23 are under audit.

  
(Authorized Signatory)

डि. सु.  
D. SUDHARSHAN  
वरिष्ठ वित्तप्रबंधक (वित्त)/Sr. General Manager (Finance)  
पावरग्रिड को.का. / POWERGRID, CC

Name D Sudharshan, Senior General Manager  
Date 15/5/23



Certified by Statutory Auditor

Name R. Balasubramanian For S. Namanang Aiyar & Co.  
Chartered Accountants  
Place New Delhi' FSN : 000900N

  
R. Balasubramanian  
Partner  
M. No. : 080432  
15 MAY 2023



Date 15/5/23

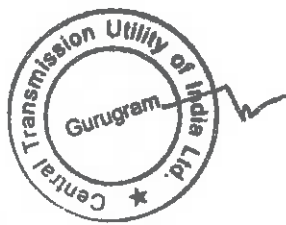



245

**Attachment  
to  
Format for  
Qualification Requirement  
(B. Technical Requirement)**

**Annual Reports of 2016-2017, 2017-18,  
2018-19 , 2019-20, 2020-21 & 2021-22  
(Enclosed at the end)**



  
**डि. सुदर्शन**  
**D. SUDHARSHAN**  
वरिष्ठ महासंचालक (वित्त)/Sr. General Manager (Finance)  
पावरग्रिड कॉ.का./ POWERGRID, CC

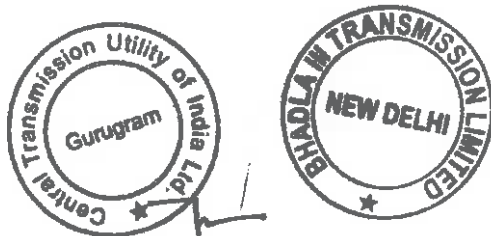

  
\_\_\_\_\_

29

246

**D. ADDITIONAL INFORMATION FOR VERIFICATION OF FINANCIAL AND TECHNICAL CAPABILITIES OF BIDDERS.**

Name of Bidder: Power Grid Corporation of India Limited.

- i. **Financial capability (Attachment 1)**
  - a. Annual Reports of Financial years 2019-20, 2020-21, 2021-22
- ii. **Technical capability (Attachment 2) – as per the format**
- iii. **Attachment-3**
  - a. Certificate of Commercial Operation of the projects
  - b. Certificate of Regional Transmission system availability

For and on behalf of

M/s Power Grid Corporation of India Limited

.....  
(Signature of authorised signatory)

Name: D Sudharshan  
Designation: Senior General Manager

Date: 19/06/23  
Place: Gurgaon

डि. सुदर्शन  
D. SUDHARSHAN  
सीनियर जनरल मैनेजर (फिनांस) / Sr. General Manager (Finance)  
पावरग्रिड कॉर्पोरेशन ऑफ इंडिया लिमिटेड / POWERGRID, CC

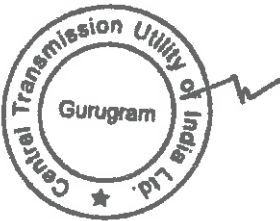

Sio..

30

247

# Attachment - 1

to

## Qualification Requirement

### (D. Format for Additional Information for verification of Financial & Technical Capabilities of Bidders)

#### Financial Capability

1. Annual Reports of 2019-20, 2020-21 & 2021-22  
(enclosed at the end)



  
डि. सुदर्शन  
D. SUDHARSHAN  
सीनियर प्रोफेशनल (फिन्स) / Sr. General Manager (Finance)  
पावरग्रिड कं.क. / POWERGRID, CC

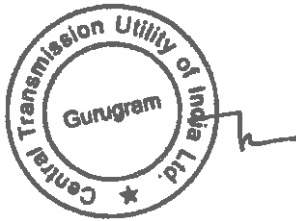



31

248



# Attachment - 2

to

## Qualification Requirement

### (D. Format for Additional Information for verification of Financial & Technical Capabilities of Bidders)

Technical Capability (as per format)



*[Handwritten signature]*

डि. सुदर्शन  
D. SUDHARSHAN  
सीनियर मैनेजर (फिन्स) / Sr. General Manager (Finance)  
पावरग्रिड को.कॉ. / POWERGRID, CC

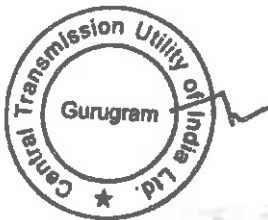

Dr.

३२

249

**Technical capability**

Particulars	2021-22	2021-22	2021-22	2020-21
Name(s) of project(s) from Infrastructure sectors	HVDC Bipole link between Western Region (Raigarh, Chattisgarh) and Southern Region (Pugalur, Tamil Nadu) - North Trichur (Kerala) - Scheme#1: Raigarh-Pugalur 6000 MW HVDC System	HVDC Bipole link between Western Region (Raigarh, Chattisgarh) and Southern Region (Pugalur, Tamil Nadu) - North Trichur (Kerala) - Scheme#2: AC System Strengthening at Pugalur end	HVDC Bipole link between Western Region (Raigarh, Chattisgarh) and Southern Region (Pugalur, Tamil Nadu)-North Trichur (Kerala)- Scheme#3: Pugalur-Trichur 2000 MW VSC based HVDC system	Additional ATS for Tumkur (Pavagada) [Transmission System for Ultra Mega Solar Park at Tumkur (Pavagada), Karnataka-Phase II (Part-B)]
Location(s) including country(s) where project was set up	Western Region and Southern Region, India	Southern Region, India	Southern Region, India	Southern Region, India
Nature of Project	Inter State Transmission System (ISTS)	Inter State Transmission System (ISTS)	Inter State Transmission System (ISTS)	Inter State Transmission System (ISTS)
Voltage level (if any)	800kV	400kV	220kV, 320kV & 400kV	400kV
Capital cost of project(s) Rs. in Crore #	13,025.56	2222.75	4620.47	515.45
Status of the project*	25-Oct-2021	25-Oct-2021	08-Jun-21	01-Mar-21
% of equity owned in the project(s)	100%	100%	100%	100%

\* Capital cost of the project as on Date of Commercial Operation

\* Date of Commercial Operation

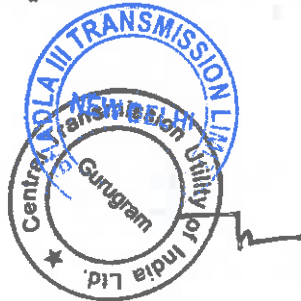

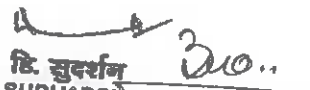
  
**डि. सुदर्शन**  
 D. SUDHARSHAN  
 वरिष्ठ प्रशासक (वित्त) / Sr. General Manager (Finance)  
 पावरग्रिड कं.का. / POWERGRID, CC



33

250



**Project Name : HVDC Bipole link between Western Region (Raigarh, Chattisgarh) and Southern Region (Pugalur, Tamil Nadu) – North Trichur (Kerala) – Scheme#1: Raigarh-Pugalur 6000 MW HVDC System**

• **Project model :**  
BOOM

• **Debt financing and equity raised and provided by Bidder for the project, including names of lenders and investors;**  
Debt (Domestic Loans/Bonds) – 70%  
Equity (Internal Resources) – 30%

• **Size and type of installation; Technical data/information on major equipment installed**  
800kV HVDC Transmission line– 1765.15 km  
800kV HVDC Terminals

• **Description of role performed by the Bidder on the project**  
Establishment, operation and maintenance of the Project on build, own, operate and maintain basis and completion of all the activities for the Project, including survey, detailed project report formulation, arranging finance, project management, necessary Consents, Clearances and Permits (way leave, environment & forest, civil aviation, railway/ road/river/canal/power crossing/PTCC, etc.), land compensation, design, engineering, procurement of equipment / material, construction, erection, testing & commissioning.

• **Clearances taken by the Bidder**  
All requisite clearances including the following:

- CEA Clearance for charging the line.
- PTCC clearance
- Railway line crossing clearance
- Forest clearance
- Power line crossing clearance
- Civil Aviation and Defence Aviation clearance
- CEA Clearance for charging the bays.
- Clearance of equipment manufacturer for charging.

• **Cost data (breakdown of major components) (in Rs. Crore)**

Transmission line	-	6138.71
Substation	-	5,750.72
Building & Civil Works	-	951.53
Land	-	19.27
PLCC	-	80.93
IT Equipment and Software	-	84.40

• **Name of EPC and/or other major contractor**  
Names of suppliers of goods and services

-ABB, BHEL  
-Tata Projects, KPTL, EMCO, Transrail Lighting, KEC, L&T, Unitech Power Transmission Ltd  
-Nanjing Electric (Group) Co. Ltd, Zhengzhou Xianghe Group, Gk Xianghe Electricals Pvt Ltd, M/S. Jiangdong Fittings Equipment, ZTT India Private Limited

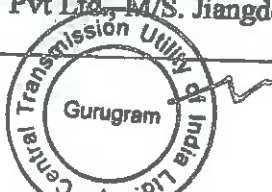

34 257  
B. SUDHARSHAN  
वरिष्ठ वित्तप्रबंधक (फिन्) / Sr. General Manager (Finance)  
पावरग्रिड के.का. / POWERGRID, CC

Galaxy Transmission, Sterlite Power Transmission Ltd, APAR. , Gupta Power, Hindusthan Urban Infrastructure, Neccon Power & Infra Limited, Prem Cables Private Limited

-TAG Corporation, EMI Transmission, Karamtara, IAC Electricals Private Limited

- **Construction time for the project**  
About 65 months (May-2016 till Oct-2021)
- **Names, addresses and contact numbers of owners of the projects**  
Corporate Office:  
Power Grid Corporation of India Ltd.,  
Saudamini, Plot No. 2, Sector 29, Gurgaon-122001 (Haryana)  
Ph. No: 0124 2571991 Fax: 0124 2571989
- **Operating reliability over the past five (5) years or since date of commercial operation**  
The Statement of availability is enclosed at Attachment-3.
- **Operating environmental compliance history**  
All compliances met
- **Names of supervisory entities or consultant, if any**  
Nil
- **Date of commercial operation:**  
25-Oct-2021
- **Total duration of operation**  
25-Oct-2021 till date (> 18 months)

**Project Name : HVDC Bipole link between Western Region (Raigarh, Chattisgarh) and Southern Region (Pugalur, Tamil Nadu) – North Trichur (Kerala) – Scheme#2: AC System Strengthening at Pugalur end**

- **Project model :**  
BOOM
- **Debt financing and equity raised and provided by Bidder for the project, including names of lenders and investors;**  
Debt (Domestic Loans/Bonds) – 70%  
Equity (Internal Resources) – 30%
- **Size and type of installation; Technical data/information on major equipment installed**  
400kV D/C Transmission line – 399.53 km  
400kV bays
- **Description of role performed by the Bidder on the project**  
Establishment, operation and maintenance of the Project on build, own, operate and maintain basis and completion of all the activities for the Project, including survey, detailed project report formulation, arranging finance, project management, necessary Consents, Clearances and Permits (way leave, environment & forest, civil aviation, railway/ road/river/canal/power PTCC, etc.), land compensation, design, engineering, procurement of equipment/material, construction, erection, testing & commissioning.

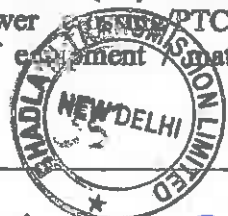
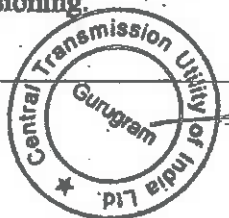

*[Signature]*

D. SUDHARSHAN

वरिष्ठ प्रबंधक (वित्त)/Sr. General Manager (Finance)  
शक्ति प्रसारण के.कॉ. / POWERGRID, CC

25

• **Clearances taken by the Bidder**

All requisite clearances including the following:

- CEA Clearance for charging the line.
- PTCC clearance
- Railway line crossing clearance
- Forest clearance
- Power line crossing clearance
- Civil Aviation and Defence Aviation clearance
- CEA Clearance for charging the bays.
- Clearance of equipment manufacturer for charging.

• **Cost data (breakdown of major components) (in Rs. Crore)**

Transmission line	- 1,961.66
Substation	- 245.00
Building & Civil Works	- 4.44
PLCC	- 10.96
IT Equipment and Software	- 0.69

• **Name of EPC and/or other major contractor**

Names of suppliers of goods and services

-KBC

-Sterlite Power Transmission Limited, Gupta, Transrail, Apar, Simplex, EMC Ltd  
Smita, Hindustan

-BHEL, Deccan, Goldstone

-ZTT India Private Limited, ABB

-KSA Power

• **Construction time for the project**

About 50 months ( August-2017 till Oct -2021)

• **Names, addresses and contact numbers of owners of the projects**

Corporate Office:

Power Grid Corporation of India Ltd.,

Saudamini, Plot No. 2, Sector 29, Gurgaon-122001 (Haryana)

Ph. No: 0124 2571991 Fax: 0124 2571989

• **Operating reliability over the past five (5) years or since date of commercial operation**  
The Statement of availability is enclosed at Attachment-3.

• **Operating environmental compliance history**  
All compliances met

• **Names of supervisory entities or consultant, if any**

Nil

**Date of commercial operation:**

05-Oct-2021

**Total duration of operation**

05-Oct-2021 till date (> 18 months)



3  
210..

36

253

डि. सुदर्शन  
D. SUDHARSHAN  
वरिष्ठ महासंचालक (वित्त)/Sr. General Manager (Finance)  
शक्ति विद्युत को.सं. / POWERGRID, CC

**Project Name : HVDC Bipole link between Western Region (Raigarh, Chattisgarh) and Southern Region (Pugalur, Tamil Nadu)-North Trichur (Kerala)-Scheme#3: Pugalur-Trichur 2000 MW VSC based HVDC system**

• **Project model :**  
BOOM

• **Debt financing and equity raised and provided by Bidder for the project, including names of lenders and investors;**  
Debt (Domestic Loans/Bonds) – 70%  
Equity (Internal Resources) – 30%

• **Size and type of installation; Technical data/information on major equipment installed**  
320kV HVDC Transmission line– 165.172 km  
400kV HVAC Transmission Line- 0.618 km  
320kV HVDC Station  
400kV bays

• **Description of role performed by the Bidder on the project**  
Establishment, operation and maintenance of the Project on build, own, operate and maintain basis and completion of all the activities for the Project, including survey, detailed project report formulation, arranging finance, project management, necessary Consents, Clearances and Permits (way leave, environment & forest, civil aviation, railway/ road/river/canal/power crossing/PTCC, etc.), land compensation, design, engineering, procurement of equipment / material, construction, erection, testing & commissioning.

• **Clearances taken by the Bidder**  
All requisite clearances including the following:

- CEA Clearance for charging the line.
- PTCC clearance
- Railway line crossing clearance
- Forest clearance
- Power line crossing clearance
- Civil Aviation and Defence Aviation clearance
- CEA Clearance for charging the bays.
- Clearance of equipment manufacturer for charging.

• **Cost data (breakdown of major components) (in Rs. Crore)**

Transmission line	-	1225.43
Substation	-	3112.51
Building & Civil Works	-	219.13
Land	-	35.10
PLCC	-	3.20
IT Equipment and Software	-	25.10

**Name of EPC and/or other major contractor**  
**Names of suppliers of goods and services**  
-JV of Siemens Akiengesellschaft & Sumitomo, L&T

• **Construction time for the project**  
About 52 months (Feb-2017 till June-2021)



डि. सुदर्शन  
D. SUDHARSHAN  
ए.सी. सुपरवाइजर (फिन)/जी. जनरल मैनेजर (फिनान्स)  
पावरग्रिड के.का./ POWERGRID, CC

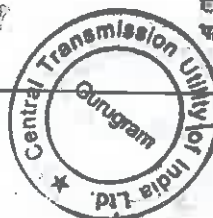

254

37

210

- **Names, addresses and contact numbers of owners of the projects**  
**Corporate Office:**  
 Power Grid Corporation of India Ltd.,  
 Saudamini, Plot No. 2, Sector 29, Gurgaon-122001 (Haryana)  
 Ph. No: 0124 2571991 Fax: 0124 2571989
- **Operating reliability over the past five (5) years or since date of commercial operation**  
 The Statement of availability is enclosed at Attachment-3.
- **Operating environmental compliance history**  
 All compliances met
- **Names of supervisory entities or consultant, if any**  
 Nil
- **Date of commercial operation:**  
 08-June-2021
- **Total duration of operation**  
 08-June-2021 till date (> 22 months)

**Project Name : Additional ATS for Tumkur (Pavagada) [Transmission System for Ultra Mega Solar Park at Tumkur (Pavagada), Karnataka-Phase II (Part-B)]**

- **Project model :**  
 BOOM
- **Debt financing and equity raised and provided by Bidder for the project, including names of lenders and investors;**  
 Debt (Domestic Loans/Bonds) – 70%  
 Equity (Internal Resources) – 30%
- **Size and type of installation; Technical data/information on major equipment installed**  
 400kV D/C Transmission line– 157.42 km  
 400kV bays
- **Description of role performed by the Bidder on the project**  
 Establishment, operation and maintenance of the Project on build, own, operate and maintain basis and completion of all the activities for the Project, including survey, detailed project report formulation, arranging finance, project management, necessary Consents, Clearances and Permits (way leave, environment & forest, civil aviation, railway/ road/river/canal/power crossing/PTCC, etc.), land compensation, design, engineering, procurement of equipment / material, construction, erection, testing & commissioning.
- **Clearances taken by the Bidder**  
 All requisite clearances including the following:
  - CEA Clearance for charging the line.
  - PTCC clearance
  - Railway line crossing clearance
  - Forest clearance
  - Power line crossing clearance
  - Civil Aviation Defence Aviation clearance



**डि. सुदर्शन**  
**D. SUDHARSHAN**  
 सहायक वित्त (सि)/Sr. General Manager (Finance)  
 पावरग्रिड के.एन. / POWERGRID, CC

28

255





- CEA Clearance for charging the bays.
- Clearance of equipment manufacturer for charging.
- **Cost data (breakdown of major components) (in Rs. Crore)**

Transmission line	- 449.32
Substation	- 57.81
PLCC	6.48
IT Equipment and Software	- 1.84
- **Name of EPC and/or other major contractor**  
Names of suppliers of goods and services  
-KEC
- **-Construction time for the project**  
About 46 months (May-2017 till March -2021)
- **Names, addresses and contact numbers of owners of the projects**  
Corporate Office:  
Power Grid Corporation of India Ltd.,  
Saudamini, Plot No. 2, Sector 29, Gurgaon-122001 (Haryana)  
Ph. No: 0124 2571991 Fax: 0124 2571989
- **Operating reliability over the past five (5) years or since date of commercial operation**  
The Statement of availability is enclosed at Attachment-3.
- **Operating environmental compliance history**  
All compliances met
- **Names of supervisory entities or consultant, if any**  
Nil
- **Date of commercial operation:**  
01-Mar-21
- **Total duration of operation**  
01-Mar-21 till date (> 25 months)



  
**डि. सुदर्शन**  
**D. SUDHARSHAN**  
 वरिष्ठ वित्त प्रबंधक (फिन) / Sr. General Manager (Finance)  
 पावरग्रिड के.एन. / POWERGRID, CC

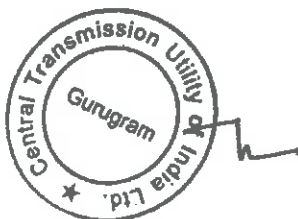

2/10..

39  
256





## Attachment - 3

to

### Qualification Requirement

#### (D. Format for Additional Information for verification of Financial & Technical Capabilities of Bidders)

1. Certificate of Commercial Operation of the projects
2. Certificate of System Availability



  
डि. सुदर्शन  
D. SUDHARSHAN  
जीनरल मैनेजर (फिन)/Sr. General Manager (Finance)  
पावरग्रिड कं.का. / POWERGRID, CC

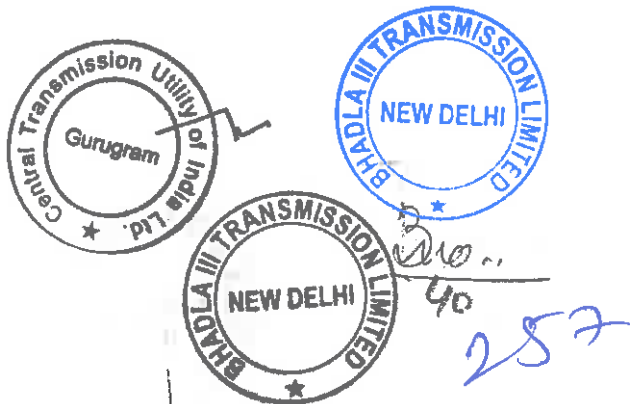





POWERGRID

POWER GRID CORPORATION OF INDIA LIMITED  
(A Government of India Enterprise)

Ref: SR-2/COMML/2020-21

Date: 09.03.2021

Encl. - 5

**NOTIFICATION OF COMMERCIAL OPERATION**

This is further to our Notification of Trial Operation dated 23.02.2021. Consequent to the successful completion of Trial Operation, the following asset under "HVDC Bipole link between Western Region (Raigarh, Chhattisgarh) and Southern Region (Pugalur, Tamil Nadu) - North Trichur (Kerala) - Scheme#1: Raigarh-Pugalur 6000MW HVDC System" has been put under commercial operation with effect from 00:00 hours of 9<sup>th</sup> March 2021 in terms of Clause 1 of Regulation (5) of Central Electricity Regulatory Commission (Terms and Conditions of Tariff Regulations, 2019):

- +/- 800KV 1500 MW (Pole-II) HVDC terminal each at Raigarh (HVDC Station) & Pugalur (HVDC Station).

Transmission charges for the above asset is payable w.e.f. 9<sup>th</sup> March 2021 as per the tariff orders issued by CEREC from time to time.



**ABHAY CHOUDHARY**  
Director (Projects)  
POWERGRID

**(S Kavi)**  
Executive Director (SR-II)

For: D SUDH...  
Chief Manager (Finance) / Sr. Genl. Mgr. (Finance)  
Power Grid Corporation of India / POWERGRID, CC

1. Chairman & Managing Director, APTRANSCO, Vidyut Soudha, Near Axis Bank, Bluru Road, Gundala, Vijayawada-520004.
2. Chairman & Managing Director, TSTRANSCO, Vidyut Soudha, Khairatabad, Hyderabad-82.
3. Chairman & Managing Director, Kerala State Electricity Board Limited (KSEBL), Vaidyuthi Bhavanam, Pattom, Thiruvananthapuram - 695 004.
4. Chairman & Managing Director, TANGEDCO, NPKRR Maaligai, 300, Anna Salai, Chennai - 600 002.
5. Managing Director, Karnataka Power Transmission Corporation Ltd., (KPTCL), Kaveri Bhavan, Bangalore - 560 009.
6. Chief Secretary, Electricity Department, Govt of Pondicherry, Pondicherry - 605001
7. Chief Secretary, Electricity Department, Govt of Goa, Panaji
8. Managing Director, Eastern Power Distribution Company of Andhra Pradesh Limited (APEPDCL), APEPDCL, P&T Colony, Seethimadhara, VISHAKHAPATNAM, Andhra Pradesh,
9. Managing Director, Southern Power Distribution Company of Andhra Pradesh Limited (APSPDCL), D.No: 19-13-65/A, Srinivasapuram, Corporate Office, Tiruchanoor Road, TIRUPATI-517 503, Chittoor District, Andhra Pradesh.
10. Managing Director, Southern Power Distribution Company of Telangana Limited (TSSPDCL), 6-1-50, Corporate Office, Mint Compound, HYDERABAD - 500 063, Telangana.
11. Managing Director, Northern Power Distribution Company of Telangana Limited (TSNPDCL), H.No 2-5-3 1/2, Vidyut Bhawan, Corporate Office, Nakkal Gutta, Hanamkonda, WARANGAL - 506 001, Telangana.

CERTIFIED TRUE

पश्चिमी क्षेत्र चरफत प्रणाली - II लोडिंग युक्तियुक्त, उत्तर-पूर्व, उत्तर-पूरु के चरफत प्रणाली, कोलकाता, बंगलूर  
Southern Region Transmission System - II RTO, Near RTD Driving Test Track, Shyambazar, Kolkata, West Bengal  
कोलकाता कार्यालय: "सिद्धार्थ", चरफत नं: 2, चरफत-29, युक्तियुक्त (24x7x365) कोलकाता-700016, बंगलूर कार्यालय: 24-257 17  
Corporate Office: "Sudharsh", Plot No. 2, Sector-23, Gurgaon-122001, (Haryana) India. Phone: 012-2671700-1, 2671700-2, 2671700-3, 2671700-4, 2671700-5, 2671700-6, 2671700-7, 2671700-8, 2671700-9, 2671700-10, 2671700-11, 2671700-12, 2671700-13, 2671700-14, 2671700-15, 2671700-16, 2671700-17, 2671700-18, 2671700-19, 2671700-20, 2671700-21, 2671700-22, 2671700-23, 2671700-24, 2671700-25, 2671700-26, 2671700-27, 2671700-28, 2671700-29, 2671700-30, 2671700-31, 2671700-32, 2671700-33, 2671700-34, 2671700-35, 2671700-36, 2671700-37, 2671700-38, 2671700-39, 2671700-40, 2671700-41, 2671700-42, 2671700-43, 2671700-44, 2671700-45, 2671700-46, 2671700-47, 2671700-48, 2671700-49, 2671700-50, 2671700-51, 2671700-52, 2671700-53, 2671700-54, 2671700-55, 2671700-56, 2671700-57, 2671700-58, 2671700-59, 2671700-60, 2671700-61, 2671700-62, 2671700-63, 2671700-64, 2671700-65, 2671700-66, 2671700-67, 2671700-68, 2671700-69, 2671700-70, 2671700-71, 2671700-72, 2671700-73, 2671700-74, 2671700-75, 2671700-76, 2671700-77, 2671700-78, 2671700-79, 2671700-80, 2671700-81, 2671700-82, 2671700-83, 2671700-84, 2671700-85, 2671700-86, 2671700-87, 2671700-88, 2671700-89, 2671700-90, 2671700-91, 2671700-92, 2671700-93, 2671700-94, 2671700-95, 2671700-96, 2671700-97, 2671700-98, 2671700-99, 2671700-100

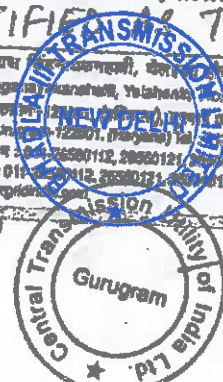
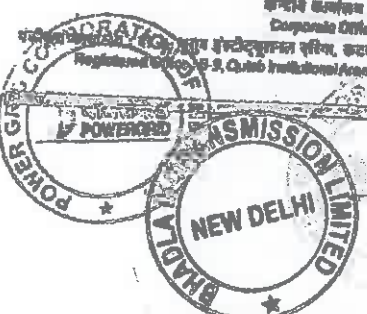

डि. सुधर्शन  
D. SUDHARSHAN  
Chief Manager (Finance) / Sr. General Manager (Finance)  
Power Grid Corporation of India / POWERGRID, CC







Ref: BR-2/COMML/2021-22

POWER GRID CORPORATION OF INDIA LIMITED  
(A Government of India Enterprise)

Date: 25.10.2021

**NOTIFICATION OF COMMERCIAL OPERATION**

ENCL-1

This is further to our Notification of Trial Operation dated 23.10.2021. Consequent to the successful completion of Trial Operation, the following asset under "HVDC Bipole link between Western Region (Raigarh, Chhattisgarh) and Southern Region (Pugalur, Tamil Nadu) - North Trichur (Kerala) - Scheme#1: Raigarh-Pugalur 6000MW HVDC System" has been put under commercial operation with effect from 00:00 hours of 25<sup>th</sup> October 2021 in terms of Clause 1 of Regulation (5) of Central Electricity Regulatory Commission (Terms and Conditions of Tariff) Regulations, 2019:

\* +/- 600KV 1500 MW (Pole-IV) HVDC terminal each at Raigarh (HVDC Station) & Pugalur (HVDC Station).

Transmission charges for the above asset is payable w.e.f. 25<sup>th</sup> October 2021 as per the tariff orders issued by CBRC from time to time.

→

डि. सुदर्शन  
D. SUDHARSHAN  
जीनियर जनरल मैनेजर (फाइनेंस)  
पावरग्रिड के.का./ POWERGRID, CC

Abhay Choudhary  
ABHAY CHOUDHARY  
Director (Projects)  
POWERGRID

S Ravi  
(S Ravi)  
Executive Director (SR-II)

1. Chairman & Managing Director, APTRANSCO, Vidyut Soudha, Near Axis Bank, Eluru Road, Gundakal, Vijayawada- 520004.
2. Chairman & Managing Director, TSTRANSCO, Vidyut Soudha, Khairatabad, Hyderabad-42.
3. Chairman & Managing Director, Kerala State Electricity Board Limited (KSEBL), Vaidyuthi Bhavanam, Pattom, Thiruvananthapuram -- 695 004.
4. Chairman & Managing Director, TANGEDCO, NPKRR Maaligai, #00, Anna Salai, Chennai - 600 002.
5. Managing Director, Karnataka Power Transmission Corporation Ltd., (KPTCL), Kaveri Bhavan, Bangalore - 560 009.
6. Chief Secretary, Electricity Department, Govt of Pondicherry, Pondicherry - 605001
7. Chief Secretary, Electricity Department, Govt of Goa, Panaji
8. Managing Director, Eastern Power Distribution Company of Andhra Pradesh Limited (APEPDCL), APEPDCL, P&T Colony, Sootlamacheru, VISHAKHAPATNAM, Andhra Pradesh,
9. Managing Director, Southern Power Distribution Company of Andhra Pradesh Limited (APEPDCL), D.No: 19-13-65/A, Srisrinagar, Corporate Office, Truchanor Road, TIRUPATI-517 503, Chittoor District, Andhra Pradesh,
10. Managing Director, Southern Power Distribution Company of Telangana Limited (TSPPDCL), 6-1-3, Corporate Office, Mint Compound, HYDERABAD - 500 063, Telangana.
11. Managing Director, Northern Power Distribution Company of Telangana Limited (TSNPDCL), H.No 2-3-3, Vidyut Bhawan, Corporate Office, Nakhal Gutta, Hanamkonda, WARANGAL - 506 001, Telangana.
12. Managing Director, Bangalore Electricity Supply Company Ltd., (BEBCOM), Corporate Office, K.R. Circle, BANGALORE - 560 001, Karnataka.



दक्षिण क्षेत्र पावर ग्रिड - II सीईओ कार्यालय, एन.टी.डी. सुदर्शन रोड फ्रॉम द वॉर रिजर्वेशन, कलकत्ता रोड, बंगलूरु - 560 001  
Southern Region Transmission System - II RTD, Near RTD Dabing Bus Stand, Bangalore/Kolkata; Vaidyuthi Road, Bangalore - 560 001  
दक्षिण क्षेत्र पावर ग्रिड - II सीईओ कार्यालय, एन.टी.डी. सुदर्शन रोड फ्रॉम द वॉर रिजर्वेशन, कलकत्ता रोड, बंगलूरु - 560 001  
Corporate Office: "Sudharshan", Plot No. 2, Sector-20, Gurgaon-122001, (Haryana) Phone: 0124-2611111  
दक्षिण क्षेत्र पावर ग्रिड - II सीईओ कार्यालय, एन.टी.डी. सुदर्शन रोड फ्रॉम द वॉर रिजर्वेशन, कलकत्ता रोड, बंगलूरु - 560 001  
Regional Office: B-4, Chhatrapati Shivaji Maharaj, V.K. Rajwade, Fort, New Delhi-110 016. Tel: 011-2602112, 26020121, 26020122  
Website: www.powergrid.co.in



CERTIFIED  
26/10/21

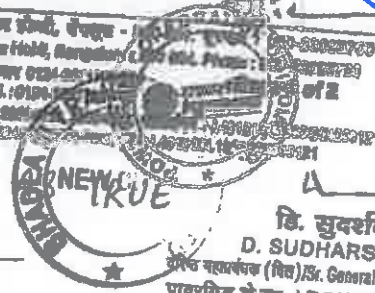

डि. सुदर्शन  
D. SUDHARSHAN  
जीनियर जनरल मैनेजर (फाइनेंस)  
पावरग्रिड के.का./ POWERGRID, CC



पावर ग्रिड कॉर्पोरेशन ऑफ इंडिया लिमिटेड  
(भारत सरकार का उद्यम)  
**POWER GRID CORPORATION OF INDIA LIMITED**  
(A Government of India Enterprise)

*Encl-2*

Ref: SR-2/COMMI/2020-21

Date: 06.09.2020

**NOTIFICATION OF COMMERCIAL OPERATION**

This is further to our Notification of Trial Operations dated 14.05.2020 & 19.08.2020. Consequent to the successful completion of Trial Operation, the following assets under "HVDC Bipole link between Western Region (Raigarh, Chhattisgarh) and Southern Region (Pugalur, Tamil Nadu) - North Trichur (Kerala) - Scheme:#2 AC System Strengthening at Pugalur end" have been put under commercial operation with effect from 00:00 hours of 06<sup>th</sup> September 2020 in terms of Clause 1 of Regulation (5) of Central Electricity Regulatory Commission (Terms and Conditions of Tariff) Regulations, 2019:

- 1) 400KV Pugalur (HVDC Station) - Pugalur (existing) (Quad) D/C Transmission line along with associated bays at Pugalur(HVDC station) & Pugalur (Existing) Substation & 2) 400 KV Pugalur (HVDC station) - Arasur (Quad) D/C transmission line along with associated bays at Pugalur (HVDC station) & Arasur Substation.

Transmission charges for the above assets are payable w.e.f. 06<sup>th</sup> September 2020 as per the tariff orders issued by CERC from time to time.

डि. सुदर्शन  
D. SUDHARSHAN

*Abhay Choudhary*  
**ABHAY CHOUDHARY**

*S Ravi*  
(S Ravi)

वरिष्ठ महाप्रबंधक (वित्त) Sr. General Manager (Finance)  
पावरग्रिड के.का. / POWERGRID, CC

Executive Director (SR-II)

- |   |  |  |
|---|--|--|
| 4 MD, KPTCL                                   | 5 CMD, KSEB Ltd                                      | 3 Chairman, TNEB Ltd                                   |
| 7 The Chief Secretary, Govt of Pondicherry    | 8 CE (Commercial), APFC, Hyderabad                   | 6 MD, TANTRANSCO                                       |
| 10 CE (SO), KSEB, Kalamassery                 | 11 CE (LDC), KPTCL, Bangalore                        | 9 CE (Commercial) TSPCC, Hyderabad                     |
| 15 SE-I, Electricity Dept Pondicherry         | 14 Chief Electrical Engineer Elect Dept, Govt of Goa | 12 Member Secretary, SRPC, Bangalore                   |
| 1 CMD, POWERGRID, Gurgaon                     | 2 Director (Projects), POWERGRID, Gurgaon            | 5 Director (Operations), POWERGRID, Gurgaon            |
| 4 Director (Finance), POWERGRID, Gurgaon      | 5 COO (CTU), POWERGRID, Gurgaon                      | 6 ED (SKLDC), POSOCO Bangalore                         |
| 7 ED (CP & CE & CMD Cell), POWERGRID, Gurgaon | 8 ED (Comm / AM/ LD & C/CMG), POWERGRID, Gurgaon     | 9 CGM (AM & Comm)/Projects, SR-II, Bangalore/Chennai   |
| Sr. Gen. Mgr. (SR-II)                         | 11 GM (SOP), SR-II                                   | 12 Station In-charge, Pugalur HVDC/ Pugalur/ Arasur ES |



दक्षिणी क्षेत्र परिवहन प्रणाली - ★ सीईओ, गुवागम, आर.टी.ओ. इन्टरियर टेस्ट ट्रैक के पास सिंगायकराहाल, गुवागम जिल्ला, केरल - 560 084. दूरभाष : 080-23083700  
Southern Region Transmission System - II RHQ, Near RTO Driving Test Track, Singayankarahal, Yelkannur Taluk, Gurugram Distt - 560 084. Phone : 080-23083700  
केन्द्रीय कार्यालय : "गुरुग्राम", प्लॉट नं: 2, सेक्टर-29, गुवागम-122001, हरियाणा। दूरभाष : 011-26080112, 26080113, 26080114, 26080115, 26080116, 26080117, 26080118, 26080119, 26080120, 26080121, 26080122, 26080123, 26080124, 26080125, 26080126, 26080127, 26080128, 26080129, 26080130, 26080131, 26080132, 26080133, 26080134, 26080135, 26080136, 26080137, 26080138, 26080139, 26080140, 26080141, 26080142, 26080143, 26080144, 26080145, 26080146, 26080147, 26080148, 26080149, 26080150, 26080151, 26080152, 26080153, 26080154, 26080155, 26080156, 26080157, 26080158, 26080159, 26080160, 26080161, 26080162, 26080163, 26080164, 26080165, 26080166, 26080167, 26080168, 26080169, 26080170, 26080171, 26080172, 26080173, 26080174, 26080175, 26080176, 26080177, 26080178, 26080179, 26080180, 26080181, 26080182, 26080183, 26080184, 26080185, 26080186, 26080187, 26080188, 26080189, 26080190, 26080191, 26080192, 26080193, 26080194, 26080195, 26080196, 26080197, 26080198, 26080199, 26080200, 26080201, 26080202, 26080203, 26080204, 26080205, 26080206, 26080207, 26080208, 26080209, 26080210, 26080211, 26080212, 26080213, 26080214, 26080215, 26080216, 26080217, 26080218, 26080219, 26080220, 26080221, 26080222, 26080223, 26080224, 26080225, 26080226, 26080227, 26080228, 26080229, 26080230, 26080231, 26080232, 26080233, 26080234, 26080235, 26080236, 26080237, 26080238, 26080239, 26080240, 26080241, 26080242, 26080243, 26080244, 26080245, 26080246, 26080247, 26080248, 26080249, 26080250, 26080251, 26080252, 26080253, 26080254, 26080255, 26080256, 26080257, 26080258, 26080259, 26080260, 26080261, 26080262, 26080263, 26080264, 26080265, 26080266, 26080267, 26080268, 26080269, 26080270, 26080271, 26080272, 26080273, 26080274, 26080275, 26080276, 26080277, 26080278, 26080279, 26080280, 26080281, 26080282, 26080283, 26080284, 26080285, 26080286, 26080287, 26080288, 26080289, 26080290, 26080291, 26080292, 26080293, 26080294, 26080295, 26080296, 26080297, 26080298, 26080299, 26080300, 26080301, 26080302, 26080303, 26080304, 26080305, 26080306, 26080307, 26080308, 26080309, 26080310, 26080311, 26080312, 26080313, 26080314, 26080315, 26080316, 26080317, 26080318, 26080319, 26080320, 26080321, 26080322, 26080323, 26080324, 26080325, 26080326, 26080327, 26080328, 26080329, 26080330, 26080331, 26080332, 26080333, 26080334, 26080335, 26080336, 26080337, 26080338, 26080339, 26080340, 26080341, 26080342, 26080343, 26080344, 26080345, 26080346, 26080347, 26080348, 26080349, 26080350, 26080351, 26080352, 26080353, 26080354, 26080355, 26080356, 26080357, 26080358, 26080359, 26080360, 26080361, 26080362, 26080363, 26080364, 26080365, 26080366, 26080367, 26080368, 26080369, 26080370, 26080371, 26080372, 26080373, 26080374, 26080375, 26080376, 26080377, 26080378, 26080379, 26080380, 26080381, 26080382, 26080383, 26080384, 26080385, 26080386, 26080387, 26080388, 26080389, 26080390, 26080391, 26080392, 26080393, 26080394, 26080395, 26080396, 26080397, 26080398, 26080399, 26080400, 26080401, 26080402, 26080403, 26080404, 26080405, 26080406, 26080407, 26080408, 26080409, 26080410, 26080411, 26080412, 26080413, 26080414, 26080415, 26080416, 26080417, 26080418, 26080419, 26080420, 26080421, 26080422, 26080423, 26080424, 26080425, 26080426, 26080427, 26080428, 26080429, 26080430, 26080431, 26080432, 26080433, 26080434, 26080435, 26080436, 26080437, 26080438, 26080439, 26080440, 26080441, 26080442, 26080443, 26080444, 26080445, 26080446, 26080447, 26080448, 26080449, 26080450, 26080451, 26080452, 26080453, 26080454, 26080455, 26080456, 26080457, 26080458, 26080459, 26080460, 26080461, 26080462, 26080463, 26080464, 26080465, 26080466, 26080467, 26080468, 26080469, 26080470, 26080471, 26080472, 26080473, 26080474, 26080475, 26080476, 26080477, 26080478, 26080479, 26080480, 26080481, 26080482, 26080483, 26080484, 26080485, 26080486, 26080487, 26080488, 26080489, 26080490, 26080491, 26080492, 26080493, 26080494, 26080495, 26080496, 26080497, 26080498, 26080499, 26080500, 26080501, 26080502, 26080503, 26080504, 26080505, 26080506, 26080507, 26080508, 26080509, 26080510, 26080511, 26080512, 26080513, 26080514, 26080515, 26080516, 26080517, 26080518, 26080519, 26080520, 26080521, 26080522, 26080523, 26080524, 26080525, 26080526, 26080527, 26080528, 26080529, 26080530, 26080531, 26080532, 26080533, 26080534, 26080535, 26080536, 26080537, 26080538, 26080539, 26080540, 26080541, 26080542, 26080543, 26080544, 26080545, 26080546, 26080547, 26080548, 26080549, 26080550, 26080551, 26080552, 26080553, 26080554, 26080555, 26080556, 26080557, 26080558, 26080559, 26080560, 26080561, 26080562, 26080563, 26080564, 26080565, 26080566, 26080567, 26080568, 26080569, 26080570, 26080571, 26080572, 26080573, 26080574, 26080575, 26080576, 26080577, 26080578, 26080579, 26080580, 26080581, 26080582, 26080583, 26080584, 26080585, 26080586, 26080587, 26080588, 26080589, 26080590, 26080591, 26080592, 26080593, 26080594, 26080595, 26080596, 26080597, 26080598, 26080599, 26080600, 26080601, 26080602, 26080603, 26080604, 26080605, 26080606, 26080607, 26080608, 26080609, 26080610, 26080611, 26080612, 26080613, 26080614, 26080615, 26080616, 26080617, 26080618, 26080619, 26080620, 26080621, 26080622, 26080623, 26080624, 26080625, 26080626, 26080627, 26080628, 26080629, 26080630, 26080631, 26080632, 26080633, 26080634, 26080635, 26080636, 26080637, 26080638, 26080639, 26080640, 26080641, 26080642, 26080643, 26080644, 26080645, 26080646, 26080647, 26080648, 26080649, 26080650, 26080651, 26080652, 26080653, 26080654, 26080655, 26080656, 26080657, 26080658, 26080659, 26080660, 26080661, 26080662, 26080663, 26080664, 26080665, 26080666, 26080667, 26080668, 26080669, 26080670, 26080671, 26080672, 26080673, 26080674, 26080675, 26080676, 26080677, 26080678, 26080679, 26080680, 26080681, 26080682, 26080683, 26080684, 26080685, 26080686, 26080687, 26080688, 26080689, 26080690, 26080691, 26080692, 26080693, 26080694, 26080695, 26080696, 26080697, 26080698, 26080699, 26080700, 26080701, 26080702, 26080703, 26080704, 26080705, 26080706, 26080707, 26080708, 26080709, 26080710, 26080711, 26080712, 26080713, 26080714, 26080715, 26080716, 26080717, 26080718, 26080719, 26080720, 26080721, 26080722, 26080723, 26080724, 26080725, 26080726, 26080727, 26080728, 26080729, 26080730, 26080731, 26080732, 26080733, 26080734, 26080735, 26080736, 26080737, 26080738, 26080739, 26080740, 26080741, 26080742, 26080743, 26080744, 26080745, 26080746, 26080747, 26080748, 26080749, 26080750, 26080751, 26080752, 26080753, 26080754, 26080755, 26080756, 26080757, 26080758, 26080759, 26080760, 26080761, 26080762, 26080763, 26080764, 26080765, 26080766, 26080767, 26080768, 26080769, 26080770, 26080771, 26080772, 26080773, 26080774, 26080775, 26080776, 26080777, 26080778, 26080779, 26080780, 26080781, 26080782, 26080783, 26080784, 26080785, 26080786, 26080787, 26080788, 26080789, 26080790, 26080791, 26080792, 26080793, 26080794, 26080795, 26080796, 26080797, 26080798, 26080799, 26080800, 26080801, 26080802, 26080803, 26080804, 26080805, 26080806, 26080807, 26080808, 26080809, 26080810, 26080811, 26080812, 26080813, 26080814, 26080815, 26080816, 26080817, 26080818, 26080819, 26080820, 26080821, 26080822, 26080823, 26080824, 26080825, 26080826, 26080827, 26080828, 26080829, 26080830, 26080831, 26080832, 26080833, 26080834, 26080835, 26080836, 26080837, 26080838, 26080839, 26080840, 26080841, 26080842, 26080843, 26080844, 26080845, 26080846, 26080847, 26080848, 26080849, 26080850, 26080851, 26080852, 26080853, 26080854, 26080855, 26080856, 26080857, 26080858, 26080859, 26080860, 26080861, 26080862, 26080863, 26080864, 26080865, 26080866, 26080867, 26080868, 26080869, 26080870, 26080871, 26080872, 26080873, 26080874, 26080875, 26080876, 26080877, 26080878, 26080879, 26080880, 26080881, 26080882, 26080883, 26080884, 26080885, 26080886, 26080887, 26080888, 26080889, 26080890, 26080891, 26080892, 26080893, 26080894, 26080895, 26080896, 26080897, 26080898, 26080899, 26080900, 26080901, 26080902, 26080903, 26080904, 26080905, 26080906, 26080907, 26080908, 26080909, 26080910, 26080911, 26080912, 26080913, 26080914, 26080915, 26080916, 26080917, 26080918, 26080919, 26080920, 26080921, 26080922, 26080923, 26080924, 26080925, 26080926, 26080927, 26080928, 26080929, 26080930, 26080931, 26080932, 26080933, 26080934, 26080935, 26080936, 26080937, 26080938, 26080939, 26080940, 26080941, 26080942, 26080943, 26080944, 26080945, 26080946, 26080947, 26080948, 26080949, 26080950, 26080951, 26080952, 26080953, 26080954, 26080955, 26080956, 26080957, 26080958, 26080959, 26080960, 26080961, 26080962, 26080963, 26080964, 26080965, 26080966, 26080967, 26080968, 26080969, 26080970, 26080971, 26080972, 26080973, 26080974, 26080975, 26080976, 26080977, 26080978, 26080979, 26080980, 26080981, 26080982, 26080983, 26080984, 26080985, 26080986, 26080987, 26080988, 26080989, 26080990, 26080991, 26080992, 26080993, 26080994, 26080995, 26080996, 26080997, 26080998, 26080999, 26081000, 26081001, 26081002, 26081003, 26081004, 26081005, 26081006, 26081007, 26081008, 26081009, 26081010, 26081011, 26081012, 26081013, 26081014, 26081015, 26081016, 26081017, 26081018, 26081019, 26081020, 26081021, 26081022, 26081023, 26081024, 26081025, 26081026, 26081027, 26081028, 26081029, 26081030, 26081031, 26081032, 26081033, 26081034, 26081035, 26081036, 26081037, 26081038, 26081039, 26081040, 26081041, 26081042, 26081043, 26081044, 26081045, 26081046, 26081047, 26081048, 26081049, 26081050, 26081051, 26081052, 26081053, 26081054, 26081055, 26081056, 26081057, 26081058, 26081059, 26081060, 26081061, 26081062, 26081063, 26081064, 26081065, 26081066, 26081067, 26081068, 26081069, 26081070, 26081071, 26081072, 26081073, 26081074, 26081075, 26081076, 26081077, 26081078, 26081079, 26081080, 26081081, 26081082, 26081083, 26081084, 26081085, 26081086, 26081087, 26081088, 26081089, 26081090, 26081091, 26081092, 26081093, 26081094, 26081095, 26081096, 26081097, 26081098, 26081099, 26081100, 26081101, 26081102, 26081103, 26081104, 26081105, 26081106, 26081107, 26081108, 26081109, 26081110, 26081111, 26081112, 26081113, 26081114, 26081115, 26081116, 26081117, 26081118, 26081119, 26081120, 26081121, 26081122, 26081123, 26081124, 26081125, 26081126, 26081127, 26081128, 26081129, 26081130, 26081131, 26081132, 26081133, 26081134, 26081135, 26081136, 26081137, 26081138, 26081139, 26081140, 26081141, 26081142, 26081143, 26081144, 26081145, 26081146, 26081147, 26081148, 26081149, 26081150, 26081151, 26081152, 26081153, 26081154, 26081155, 26081156, 26081157, 26081158, 26081159, 26081160, 26081161, 26081162, 26081163, 26081164, 2608





SR-2/COMM/2021-22

POWER GRID CORPORATION OF INDIA LIMITED  
(A Government of India Enterprise)

Date: 19.07.2021

### NOTIFICATION OF COMMERCIAL OPERATION

This is further to our Notification of Trial Operation dated 06.07.2021 and CBA Minutes of meeting dated 19.07.2021 for meeting held on 05.07.2021 on part commissioning of Raigarh- Pugalur- Trichur HVDC Transmission system. Consequent to the successful completion of Trial Operation, the following assets under "HVDC Bipole link between Western Region (Raigarh, Chhattisgarh) and Southern Region (Pugalur, Tamil Nadu)- North Trichur(Kerala) - Scheme#2: AC system strengthening at Pugalur end" have been put under commercial operation with effect from 00:00 hours of 19<sup>th</sup> July 2021 in terms of Clause 1 of Regulation (5) of Central Electricity Regulatory Commission (Terms and Conditions of Tariff) Regulations, 2019:

- Pugalur HVDC station -Edayarpalayam (TANTRANSCO) 400KV (Quad) D/c transmission line along with associated bays at Pugalur HVDC Station &
- Edayarpalayam (TANTRANSCO)- Udumalpet 400KV (Quad) D/c transmission line along with associated bays at Udumalpet S/s (Pugalur HVDC- Edayarpalayam line and Edayarpalayam - Udumalpet line are bypassed at Edayarpalayam S/s to make Pugalur HVDC - Udumalpet line as an interim arrangement).

Transmission charges for the above assets are payable w.e.f. 13<sup>th</sup> July 2021 as per the tariff orders issued by CERC from time to time.

डि. सुदर्शन  
D. SUDHARSHAN

जीनरल मैनेजर (फाइनेंस) / Sr. General Manager (Finance)  
शक्ति विद्युत निगम लि. / POWERGRID, CC

Abhay Choudhary  
ABHAY CHOUDHARY  
Director (Projects)  
POWERGRID, TRANSCO

(S Ravi)  
Executive Director (SR-II)

- 1 CMD, APTRANSCO
- 4 MD, KPTCL
- 7 The Chief Secretary, Govt of Pondicherry
- 10 CE (SO), KSEB, Kalamaserry
- 13 SE-I, Electricity Dept Pondicherry

- 5 CMD, KSEB Ltd
- 8 CE (Commercial), APPCC, Hyderabad
- 11 CE (LDC), KPTCL, Bangalore
- 14 Chief Electrical Engineer Elect Dept, Govt of Goa

- 3 Chairman, TNEB Ltd
- 6 MD, TANTRANSCO
- 9 CE (Commercial) TSPCC, Hyderabad
- 12 Member Secretary, SRPC, Bangalore

CMD, POWERGRID, Gurgaon  
4 Director (Finance), POWERGRID, Gurgaon  
7 ED (CP & CE & CMD Cell), POWERGRID, Gurgaon  
10 Sr.GM(HOF)/SR-II

2 Director (Projects), POWERGRID, Gurgaon  
3 COO (CTU), Gurgaon  
8 EY Comm / AM/ LD (CMG), POWERGRID, Gurgaon  
11 GM(HOF), SR-II

- 3 Director (Operations), POWERGRID, Gurgaon
- 6 ED (SRLDC), POSOCO B'lore
- 9 CGM (AM & Comm)/Projects, SR-II, Bangalore/Chennai
- 12 Station I/c, Pugalur HVDC (Udumalpet S/s)

भारतीय विद्युत निगम लि. / POWERGRID, CC  
Corporate Office: "Sudamini" Plot No.2, Sector-28, Gurugram-122001 (Haryana) भारत 0124 357 1700-719  
Registered Office: B-8, Outer Ring Road, Kharola Sarai, New Delhi-110 018 भारत 011-26520112, 26520121, 26520112, 26520122, 26520123, 26520124, 26520125, 26520126, 26520127, 26520128, 26520129, 26520130, 26520131, 26520132, 26520133, 26520134, 26520135, 26520136, 26520137, 26520138, 26520139, 26520140, 26520141, 26520142, 26520143, 26520144, 26520145, 26520146, 26520147, 26520148, 26520149, 26520150, 26520151, 26520152, 26520153, 26520154, 26520155, 26520156, 26520157, 26520158, 26520159, 26520160, 26520161, 26520162, 26520163, 26520164, 26520165, 26520166, 26520167, 26520168, 26520169, 26520170, 26520171, 26520172, 26520173, 26520174, 26520175, 26520176, 26520177, 26520178, 26520179, 26520180, 26520181, 26520182, 26520183, 26520184, 26520185, 26520186, 26520187, 26520188, 26520189, 26520190, 26520191, 26520192, 26520193, 26520194, 26520195, 26520196, 26520197, 26520198, 26520199, 26520200, 26520201, 26520202, 26520203, 26520204, 26520205, 26520206, 26520207, 26520208, 26520209, 26520210, 26520211, 26520212, 26520213, 26520214, 26520215, 26520216, 26520217, 26520218, 26520219, 26520220, 26520221, 26520222, 26520223, 26520224, 26520225, 26520226, 26520227, 26520228, 26520229, 26520230, 26520231, 26520232, 26520233, 26520234, 26520235, 26520236, 26520237, 26520238, 26520239, 26520240, 26520241, 26520242, 26520243, 26520244, 26520245, 26520246, 26520247, 26520248, 26520249, 26520250, 26520251, 26520252, 26520253, 26520254, 26520255, 26520256, 26520257, 26520258, 26520259, 26520260, 26520261, 26520262, 26520263, 26520264, 26520265, 26520266, 26520267, 26520268, 26520269, 26520270, 26520271, 26520272, 26520273, 26520274, 26520275, 26520276, 26520277, 26520278, 26520279, 26520280, 26520281, 26520282, 26520283, 26520284, 26520285, 26520286, 26520287, 26520288, 26520289, 26520290, 26520291, 26520292, 26520293, 26520294, 26520295, 26520296, 26520297, 26520298, 26520299, 26520300, 26520301, 26520302, 26520303, 26520304, 26520305, 26520306, 26520307, 26520308, 26520309, 26520310, 26520311, 26520312, 26520313, 26520314, 26520315, 26520316, 26520317, 26520318, 26520319, 26520320, 26520321, 26520322, 26520323, 26520324, 26520325, 26520326, 26520327, 26520328, 26520329, 26520330, 26520331, 26520332, 26520333, 26520334, 26520335, 26520336, 26520337, 26520338, 26520339, 26520340, 26520341, 26520342, 26520343, 26520344, 26520345, 26520346, 26520347, 26520348, 26520349, 26520350, 26520351, 26520352, 26520353, 26520354, 26520355, 26520356, 26520357, 26520358, 26520359, 26520360, 26520361, 26520362, 26520363, 26520364, 26520365, 26520366, 26520367, 26520368, 26520369, 26520370, 26520371, 26520372, 26520373, 26520374, 26520375, 26520376, 26520377, 26520378, 26520379, 26520380, 26520381, 26520382, 26520383, 26520384, 26520385, 26520386, 26520387, 26520388, 26520389, 26520390, 26520391, 26520392, 26520393, 26520394, 26520395, 26520396, 26520397, 26520398, 26520399, 26520400, 26520401, 26520402, 26520403, 26520404, 26520405, 26520406, 26520407, 26520408, 26520409, 26520410, 26520411, 26520412, 26520413, 26520414, 26520415, 26520416, 26520417, 26520418, 26520419, 26520420, 26520421, 26520422, 26520423, 26520424, 26520425, 26520426, 26520427, 26520428, 26520429, 26520430, 26520431, 26520432, 26520433, 26520434, 26520435, 26520436, 26520437, 26520438, 26520439, 26520440, 26520441, 26520442, 26520443, 26520444, 26520445, 26520446, 26520447, 26520448, 26520449, 26520450, 26520451, 26520452, 26520453, 26520454, 26520455, 26520456, 26520457, 26520458, 26520459, 26520460, 26520461, 26520462, 26520463, 26520464, 26520465, 26520466, 26520467, 26520468, 26520469, 26520470, 26520471, 26520472, 26520473, 26520474, 26520475, 26520476, 26520477, 26520478, 26520479, 26520480, 26520481, 26520482, 26520483, 26520484, 26520485, 26520486, 26520487, 26520488, 26520489, 26520490, 26520491, 26520492, 26520493, 26520494, 26520495, 26520496, 26520497, 26520498, 26520499, 26520500, 26520501, 26520502, 26520503, 26520504, 26520505, 26520506, 26520507, 26520508, 26520509, 26520510, 26520511, 26520512, 26520513, 26520514, 26520515, 26520516, 26520517, 26520518, 26520519, 26520520, 26520521, 26520522, 26520523, 26520524, 26520525, 26520526, 26520527, 26520528, 26520529, 26520530, 26520531, 26520532, 26520533, 26520534, 26520535, 26520536, 26520537, 26520538, 26520539, 26520540, 26520541, 26520542, 26520543, 26520544, 26520545, 26520546, 26520547, 26520548, 26520549, 26520550, 26520551, 26520552, 26520553, 26520554, 26520555, 26520556, 26520557, 26520558, 26520559, 26520560, 26520561, 26520562, 26520563, 26520564, 26520565, 26520566, 26520567, 26520568, 26520569, 26520570, 26520571, 26520572, 26520573, 26520574, 26520575, 26520576, 26520577, 26520578, 26520579, 26520580, 26520581, 26520582, 26520583, 26520584, 26520585, 26520586, 26520587, 26520588, 26520589, 26520590, 26520591, 26520592, 26520593, 26520594, 26520595, 26520596, 26520597, 26520598, 26520599, 26520600, 26520601, 26520602, 26520603, 26520604, 26520605, 26520606, 26520607, 26520608, 26520609, 26520610, 26520611, 26520612, 26520613, 26520614, 26520615, 26520616, 26520617, 26520618, 26520619, 26520620, 26520621, 26520622, 26520623, 26520624, 26520625, 26520626, 26520627, 26520628, 26520629, 26520630, 26520631, 26520632, 26520633, 26520634, 26520635, 26520636, 26520637, 26520638, 26520639, 26520640, 26520641, 26520642, 26520643, 26520644, 26520645, 26520646, 26520647, 26520648, 26520649, 26520650, 26520651, 26520652, 26520653, 26520654, 26520655, 26520656, 26520657, 26520658, 26520659, 26520660, 26520661, 26520662, 26520663, 26520664, 26520665, 26520666, 26520667, 26520668, 26520669, 26520670, 26520671, 26520672, 26520673, 26520674, 26520675, 26520676, 26520677, 26520678, 26520679, 26520680, 26520681, 26520682, 26520683, 26520684, 26520685, 26520686, 26520687, 26520688, 26520689, 26520690, 26520691, 26520692, 26520693, 26520694, 26520695, 26520696, 26520697, 26520698, 26520699, 26520700, 26520701, 26520702, 26520703, 26520704, 26520705, 26520706, 26520707, 26520708, 26520709, 26520710, 26520711, 26520712, 26520713, 26520714, 26520715, 26520716, 26520717, 26520718, 26520719, 26520720, 26520721, 26520722, 26520723, 26520724, 26520725, 26520726, 26520727, 26520728, 26520729, 26520730, 26520731, 26520732, 26520733, 26520734, 26520735, 26520736, 26520737, 26520738, 26520739, 26520740, 26520741, 26520742, 26520743, 26520744, 26520745, 26520746, 26520747, 26520748, 26520749, 26520750, 26520751, 26520752, 26520753, 26520754, 26520755, 26520756, 26520757, 26520758, 26520759, 26520760, 26520761, 26520762, 26520763, 26520764, 26520765, 26520766, 26520767, 26520768, 26520769, 26520770, 26520771, 26520772, 26520773, 26520774, 26520775, 26520776, 26520777, 26520778, 26520779, 26520780, 26520781, 26520782, 26520783, 26520784, 26520785, 26520786, 26520787, 26520788, 26520789, 26520790, 26520791, 26520792, 26520793, 26520794, 26520795, 26520796, 26520797, 26520798, 26520799, 26520800, 26520801, 26520802, 26520803, 26520804, 26520805, 26520806, 26520807, 26520808, 26520809, 26520810, 26520811, 26520812, 26520813, 26520814, 26520815, 26520816, 26520817, 26520818, 26520819, 26520820, 26520821, 26520822, 26520823, 26520824, 26520825, 26520826, 26520827, 26520828, 26520829, 26520830, 26520831, 26520832, 26520833, 26520834, 26520835, 26520836, 26520837, 26520838, 26520839, 26520840, 26520841, 26520842, 26520843, 26520844, 26520845, 26520846, 26520847, 26520848, 26520849, 26520850, 26520851, 26520852, 26520853, 26520854, 26520855, 26520856, 26520857, 26520858, 26520859, 26520860, 26520861, 26520862, 26520863, 26520864, 26520865, 26520866, 26520867, 26520868, 26520869, 26520870, 26520871, 26520872, 26520873, 26520874, 26520875, 26520876, 26520877, 26520878, 26520879, 26520880, 26520881, 26520882, 26520883, 26520884, 26520885, 26520886, 26520887, 26520888, 26520889, 26520890, 26520891, 26520892, 26520893, 26520894, 26520895, 26520896, 26520897, 26520898, 26520899, 26520900, 26520901, 26520902, 26520903, 26520904, 26520905, 26520906, 26520907, 26520908, 26520909, 26520910, 26520911, 26520912, 26520913, 26520914, 26520915, 26520916, 26520917, 26520918, 26520919, 26520920, 26520921, 26520922, 26520923, 26520924, 26520925, 26520926, 26520927, 26520928, 26520929, 26520930, 26520931, 26520932, 26520933, 26520934, 26520935, 26520936, 26520937, 26520938, 26520939, 26520940, 26520941, 26520942, 26520943, 26520944, 26520945, 26520946, 26520947, 26520948, 26520949, 26520950, 26520951, 26520952, 26520953, 26520954, 26520955, 26520956, 26520957, 26520958, 26520959, 26520960, 26520961, 26520962, 26520963, 26520964, 26520965, 26520966, 26520967, 26520968, 26520969, 26520970, 26520971, 26520972, 26520973, 26520974, 26520975, 26520976, 26520977, 26520978, 26520979, 26520980, 26520981, 26520982, 26520983, 26520984, 26520985, 26520986, 26520987, 26520988, 26520989, 26520990, 26520991, 26520992, 26520993, 26520994, 26520995, 26520996, 26520997, 26520998, 26520999, 26521000, 26521001, 26521002, 26521003, 26521004, 26521005, 26521006, 26521007, 26521008, 26521009, 26521010, 26521011, 26521012, 26521013, 26521014, 26521015, 26521016, 26521017, 26521018, 26521019, 26521020, 26521021, 26521022, 26521023, 26521024, 26521025, 26521026, 26521027, 26521028, 26521029, 26521030, 26521031, 26521032, 26521033, 26521034, 26521035, 26521036, 26521037, 26521038, 26521039, 26521040, 26521041, 26521042, 26521043, 26521044, 26521045, 26521046, 26521047, 26521048, 26521049, 26521050, 26521051, 26521052, 26521053, 26521054, 26521055, 26521056, 26521057, 26521058, 26521059, 26521060, 26521061, 26521062, 26521063, 26521064, 26521065, 26521066, 26521067, 26521068, 26521069, 26521070, 26521071, 26521072, 26521073, 26521074, 26521075, 26521076, 26521077, 26521078, 26521079, 26521080, 26521081, 26521082, 26521083, 26521084, 26521085, 26521086, 26521087, 26521088, 26521089, 26521090, 26521091, 26521092, 26521093, 26521094, 26521095, 26521096, 26521097, 26521098, 26521099, 26521100, 26521101, 26521102, 26521103, 26521104, 26521105, 26521106, 26521107, 26521108, 26521109, 26521110, 26521111, 26521112, 26521113, 26521114, 26521115, 26521116, 26521117, 26521118, 26521119, 26521120, 26521121, 26521122, 26521123, 26521124, 26521125, 26521126, 26521127, 26521128, 26521129, 26521130, 26521131, 26521132, 26521133, 26521134, 26521135, 26521136, 26521137, 26521138, 26521139, 26521140, 26521141, 26521142, 26521143, 26521144, 26521145, 26521146, 26521147, 26521148, 26521149, 26521150, 26521151, 26521152, 26521153, 26521154, 26521155, 26521156, 26521157, 26521158, 26521159, 26521160, 26521161, 26521162, 26521163, 26521164, 26521165, 26521166, 26521167, 26521168, 26521169, 26521170, 26521171, 26521172, 26521173, 26521174, 26521175, 26521176, 26521177, 26521178, 26521179, 26521180, 26521181, 26521182, 26521183, 26521184, 26521185





POWERGRID

Ref: CR/COMINT/2020-21

POWER GRID CORPORATION OF INDIA LIMITED  
A Government of India Enterprise

Date: 09.03.2021

**NOTIFICATION OF COMMERCIAL OPERATION**

This is further to our Notification of Trial Operation dated 23.02.2021. Consequent to the successful completion of Trial Operation, the following assets under "HVDC Bipole link between Western Region (Raigarh, Chattiaagarh) and Southern Region (Pugalur, Tamil Nadu) - North Trichur (Kerala) - Scheme #3: Pugalur - Trichur 2000MW VSC based HVDC system" have been put under commercial operation with effect from 00:00 hours of 9<sup>th</sup> March 2021 in terms of Clause 1 of Regulation (5) of Central Electricity Regulatory Commission (Terms and Conditions of Tariff) Regulations, 2019:

- $\pm 320$ kV VSC based 2000 MW Pugalur(HVDC) - North Trichur HVDC(Kerala) HVDC link (Part of this link, in Kerala portion, is implemented as underground cable) along with  $\pm 320$ kV 1000 MW (Mono Pole-II) HVDC terminal each at Pugalur (HVDC Station) & North Trichur (HVDC Station).
- LILO of North Trichur-Cochin 400KV (Quad) D/c line at North Trichur HVDC station along with associated bays & equipment's (GIS) at North Trichur HVDC station.
- 2 X 315 MVA 400/220/33kV 3 Ph Auto Transformers along with its associated bays & equipment's (GIS) at North Trichur HVDC station &
- 2Nos additional 220KV line bays(GIS) at North Trichur HVDC for implementation of 220KV feeder of kerala.

Transmission charges for the above assets are payable w.e.f. 9<sup>th</sup> March 2021 as per the tariff orders issued by CBRC from time to time.

  
D. SUDHARSHAN  
वरिष्ठ प्रशासक (मिन्)/Sr. General Manager (Finance)  
पावरग्रिड के.एन. / POWERGRID, CG  
To:

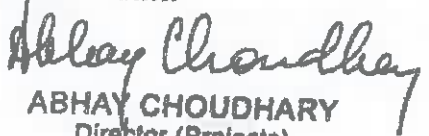
  
ABHAY CHOUDHARY  
Director (Projects)  
POWERGRID

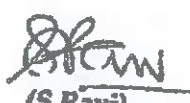
  
(S Ravi)  
Executive Director (SR-II)

1. Chairman & Managing Director, APTRANSCO, Vidyut Soudha, Near Axis Bank, Eluru Road, Gunadala, Vijayawada- 520004.
2. Chairman & Managing Director, TSTRANSCO, Vidyut Soudha, Khairatabad, Hyderabad-82.
3. Chairman & Managing Director, Kerala State Electricity Board Limited (KSEBL), Vaidyuthi Bhavanam, Pattom, Thiruvananthapuram - 695 004
4. Chairman & Managing Director, TANGEDCO, NPKRR Maaligai, 800, Anna Salai, Chennai -600 002.

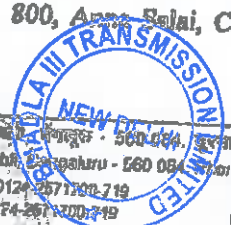
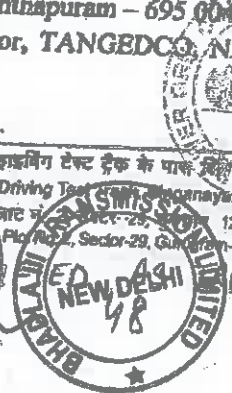

  
D. SUDHARSHAN  
वरिष्ठ प्रशासक (मिन्)/Sr. General Manager (Finance)  
पावरग्रिड के.एन. / POWERGRID, CG



Date: 06.06.2021

**NOTIFICATION OF COMMERCIAL OPERATION**

This is further to our Notification of Trial Operation dated 06.06.2021. Consequent to the successful completion of Trial Operation, the following asset under "HVDC Bipole link between Western Region (Raigarh, Chattisgarh) and Southern Region (Pugalur, Tamil Nadu) - North Trichur (Kerala) - Scheme #3: Pugalur - Trichur 2000MW VSC based HVDC system" has been put under commercial operation with effect from 00:00 hours of 06<sup>th</sup> June 2021 in terms of Clause 1 of Regulation (5) of Central Electricity Regulatory Commission (Terms and Conditions of Tariff) Regulations, 2019:

- ±320kV 1000 MW (Mono Pole-I) HVDC terminals each at Pugalur (HVDC Station) & North Trichur (HVDC Station).

Transmission charges for the above asset is payable w.e.f. 06<sup>th</sup> June 2021 as per the tariff orders issued by CBRC from time to time.

**D. SUDHARSHAN**  
 Sr. General Manager (Finance)

**Abhay Choudhary**  
**ABHAY CHOUDHARY**  
 Director (Projects)

**(S Ravi)**  
 Executive Director (SR-II)

1. Chairman & Managing Director, POWERGRIDCO, Vidyut Soudha, Near Axis Bank, Bluru Road, Gunadala, Vijayawada- 520004.
2. Chairman & Managing Director, TSTRANSCO, Vidyut Soudha, Khairatabad, Hyderabad-82.
3. Chairman & Managing Director, Kerala State Electricity Board Limited (KSEBL), Vaidyuthi Bhavanam, Pattom, Thiruvananthapuram - 695 004.
4. Chairman & Managing Director, TANGEDCO, NPKRR Maaligai, 800, Anna Salai, Chennai - 600 002.
5. Managing Director, Karnataka Power Transmission Corporation Ltd., (KPTCL), Kaveri Bhavan, Bangalore - 560 009.
6. Chief Secretary, Electricity Department, Govt of Pondicherry, Pondicherry - 605001
7. Chief Secretary, Electricity Department, Govt of Goa, Panaji
8. Managing Director, Eastern Power Distribution Company of Andhra Pradesh Limited (APEPDCL), APEPDCL, P&T Colony, Seethammadhara, VISHAKHAPATNAM, Andhra Pradesh,
9. Managing Director, Southern Power Distribution Company of Andhra Pradesh Limited (APSPDCL), H.No. 19-13-65/A, Srinivasapuram, Corporate Office, Tiruchanoor Road, TIRUPATI-517 503, Chittoor District, Andhra Pradesh.
10. Managing Director, Southern Power Distribution Company of Telangana Limited (TSSPDCL), 6-1-30, Corporate Office, Mint Compound, HYDERABAD - 500 063, Telangana.
11. Managing Director, Northern Power Distribution Company of Telangana Limited (TSNPDCL), H.No 2-5-3 1/2, Vidyut Bhawan, Corporate Office, Nakkal Gutta, Hanamkonda, WARANGAL - 506 001, Telangana.
12. Managing Director, Bangalore Electricity Supply Company Ltd. (BESCOM), Corporate Office, BANGALORE - 560 001, Karnataka.

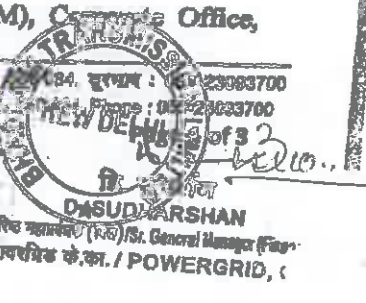
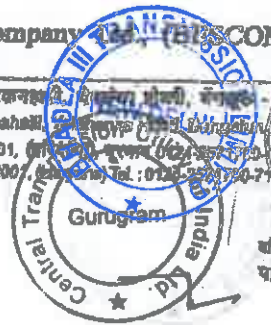
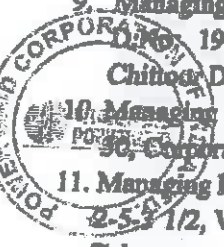

CERTIFIED AS TRUE  
 49 266

पुणे क्षेत्रीय कार्यालय, आर.टी.ओ. ड्राइंग टेस्ट ट्रॅक के पास सिंगेनयकनेहल्ली, सिंगेनयकनेहल्ली, पुणे-411 004.  
 Eastern Region Transmission Corporation - II RHC., Near RTO Driving Test Track, Singenayakanehalli, Singenayakanehalli, Pune-411 004.  
 कार्यालय: "सौभाग्य", प्लॉट नं.: 2, सेक्टर-28, गुरुग्राम-122001, हरियाणा।  
 Corporate Office: "Saubhagya", Plot No. 2, Sector-28, Gurugram-122001, Haryana। Tel.: 0120-2501700-7



Ref: BR-2/COMML/2020-21

Date: 01.03.2021

**NOTIFICATION OF COMMERCIAL OPERATION**

This is further to our Notification of Trial Operation dated 27.02.2021. Consequent to the successful completion of Trial Operation, the following asset under "Additional ATS for Tumkur (Pavagada) [Transmission System for Ultra Mega Solar Park at Tumkur (Pavagada), Karnataka -Phase-II (Part -B)]" has been put under commercial operation with effect from 00:00 hours of 1<sup>st</sup> March 2021 in terms of Clause 1 of Regulation (5) of Central Electricity Regulatory Commission (Terms and Conditions of Tariff) Regulations, 2019:

- Tumkur (Pavagada) pooling station - Devanahally (KPTCL) 400KV D/c (Quad) line (Double Circuit line with some portion on Multi-Circuit) along with associated bays and equipment's at Tumkur (Pavagada) pooling station & Devanahally (KPTCL).

Transmission charges for the above asset are payable w.e.f. 1<sup>st</sup> March 2021 as per the tariff orders issued by CERC from time to time.

डि. सुदर्शन  
D. SUDHARSHAN  
जीनरल मैनेजर (फिन्स)/Sr. General Manager (Finance)  
पावरग्रिड को.का./ POWERGRID, GC

Abhay Choudhary  
ABHAY CHOUDHARY  
डायरेक्टर (प्रोजेक्ट्स)  
DIRECTOR (Projects)  
POWERGRID

S Ravi  
(S Ravi)  
एग्जीक्यूटिव डायरेक्टर (SR-II)  
Executive Director (SR-II)

- 1 CMD, APTRANSCO
- 4 MD, KPTCL
- 7 The Chief Secretary, Govt of Pondicherry
- 10 CE (SO), KSEB, Kalamaserry
- 13 SE-I, Electricity Dept Pondicherry

- 2 CMD, TSTRANSCO
- 5 CMD, KSEB Ltd
- 8 CE (Commercial), APPCC, Hyderabad
- 11 CE (LDC), KPTCL, Bangalore
- 14 Chief Electrical Engineer Elect Dept, Govt of Goa

- 3 Chairman, TNEB Ltd
- 6 MD, TANTRANSCO
- 9 CE (Commercial) TSPCC, Hyderabad
- 12 Member Secretary, SRPC, Bangalore
- 15 Station -In charge/Devanahally, KPTCL
- 3 Director (Operations), POWERGRID, Gurgaon
- 6 ED (SRLDCC), POSOCO Bangalore
- 9 CGM (AM & Comm)/Projects, SR-II, Bangalore/Chennai
- 12 Station In-charge, Pavagada SS

- CMD, POWERGRID, Gurgaon
- 4 Director (Finance), POWERGRID, Gurgaon
- 7 ED (CF & CB & CMD Cell), POWERGRID, Gurgaon
- 10 GM(HOP), SR-II

- 2 Director (Projects), POWERGRID, Gurgaon
- 5 COO (CTU), POWERGRID, Gurgaon
- 8 ED (Comm / AM/ LD & C/CMG), POWERGRID, Gurgaon
- 11 GM(HOP), SR-II

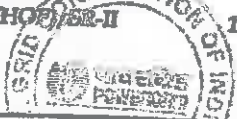

कॉर्पोरेट कार्यालय : पंचसाली, ब्लॉक नं. 2 सेक्टर-28, गुरुग्राम-122001, (हरियाणा) दूरभाष 0124-2571700-719  
Corporate Office : Panstali, Plot No.2, Sector-28, Gurgaon-122001 (Haryana) Tel : 0124-2571700-719  
पंजीकृत कार्यालय : ए-2, इंडिया इंस्टीट्यूट ऑफ मैनेजमेंट, कालमासरी, चंडीगढ़ - 110016 दूरभाष : 011-26580112, 26580121, 26584812, 26584822, 26584832, 26584842, 26584852, 26584862, 26584872, 26584882, 26584892, 26584902, 26584912, 26584922, 26584932, 26584942, 26584952, 26584962, 26584972, 26584982, 26584992, 26585002, 26585012, 26585022, 26585032, 26585042, 26585052, 26585062, 26585072, 26585082, 26585092, 26585102, 26585112, 26585122, 26585132, 26585142, 26585152, 26585162, 26585172, 26585182, 26585192, 26585202, 26585212, 26585222, 26585232, 26585242, 26585252, 26585262, 26585272, 26585282, 26585292, 26585302, 26585312, 26585322, 26585332, 26585342, 26585352, 26585362, 26585372, 26585382, 26585392, 26585402, 26585412, 26585422, 26585432, 26585442, 26585452, 26585462, 26585472, 26585482, 26585492, 26585502, 26585512, 26585522, 26585532, 26585542, 26585552, 26585562, 26585572, 26585582, 26585592, 26585602, 26585612, 26585622, 26585632, 26585642, 26585652, 26585662, 26585672, 26585682, 26585692, 26585702, 26585712, 26585722, 26585732, 26585742, 26585752, 26585762, 26585772, 26585782, 26585792, 26585802, 26585812, 26585822, 26585832, 26585842, 26585852, 26585862, 26585872, 26585882, 26585892, 26585902, 26585912, 26585922, 26585932, 26585942, 26585952, 26585962, 26585972, 26585982, 26585992, 26586002, 26586012, 26586022, 26586032, 26586042, 26586052, 26586062, 26586072, 26586082, 26586092, 26586102, 26586112, 26586122, 26586132, 26586142, 26586152, 26586162, 26586172, 26586182, 26586192, 26586202, 26586212, 26586222, 26586232, 26586242, 26586252, 26586262, 26586272, 26586282, 26586292, 26586302, 26586312, 26586322, 26586332, 26586342, 26586352, 26586362, 26586372, 26586382, 26586392, 26586402, 26586412, 26586422, 26586432, 26586442, 26586452, 26586462, 26586472, 26586482, 26586492, 26586502, 26586512, 26586522, 26586532, 26586542, 26586552, 26586562, 26586572, 26586582, 26586592, 26586602, 26586612, 26586622, 26586632, 26586642, 26586652, 26586662, 26586672, 26586682, 26586692, 26586702, 26586712, 26586722, 26586732, 26586742, 26586752, 26586762, 26586772, 26586782, 26586792, 26586802, 26586812, 26586822, 26586832, 26586842, 26586852, 26586862, 26586872, 26586882, 26586892, 26586902, 26586912, 26586922, 26586932, 26586942, 26586952, 26586962, 26586972, 26586982, 26586992, 26587002, 26587012, 26587022, 26587032, 26587042, 26587052, 26587062, 26587072, 26587082, 26587092, 26587102, 26587112, 26587122, 26587132, 26587142, 26587152, 26587162, 26587172, 26587182, 26587192, 26587202, 26587212, 26587222, 26587232, 26587242, 26587252, 26587262, 26587272, 26587282, 26587292, 26587302, 26587312, 26587322, 26587332, 26587342, 26587352, 26587362, 26587372, 26587382, 26587392, 26587402, 26587412, 26587422, 26587432, 26587442, 26587452, 26587462, 26587472, 26587482, 26587492, 26587502, 26587512, 26587522, 26587532, 26587542, 26587552, 26587562, 26587572, 26587582, 26587592, 26587602, 26587612, 26587622, 26587632, 26587642, 26587652, 26587662, 26587672, 26587682, 26587692, 26587702, 26587712, 26587722, 26587732, 26587742, 26587752, 26587762, 26587772, 26587782, 26587792, 26587802, 26587812, 26587822, 26587832, 26587842, 26587852, 26587862, 26587872, 26587882, 26587892, 26587902, 26587912, 26587922, 26587932, 26587942, 26587952, 26587962, 26587972, 26587982, 26587992, 26588002, 26588012, 26588022, 26588032, 26588042, 26588052, 26588062, 26588072, 26588082, 26588092, 26588102, 26588112, 26588122, 26588132, 26588142, 26588152, 26588162, 26588172, 26588182, 26588192, 26588202, 26588212, 26588222, 26588232, 26588242, 26588252, 26588262, 26588272, 26588282, 26588292, 26588302, 26588312, 26588322, 26588332, 26588342, 26588352, 26588362, 26588372, 26588382, 26588392, 26588402, 26588412, 26588422, 26588432, 26588442, 26588452, 26588462, 26588472, 26588482, 26588492, 26588502, 26588512, 26588522, 26588532, 26588542, 26588552, 26588562, 26588572, 26588582, 26588592, 26588602, 26588612, 26588622, 26588632, 26588642, 26588652, 26588662, 26588672, 26588682, 26588692, 26588702, 26588712, 26588722, 26588732, 26588742, 26588752, 26588762, 26588772, 26588782, 26588792, 26588802, 26588812, 26588822, 26588832, 26588842, 26588852, 26588862, 26588872, 26588882, 26588892, 26588902, 26588912, 26588922, 26588932, 26588942, 26588952, 26588962, 26588972, 26588982, 26588992, 26589002, 26589012, 26589022, 26589032, 26589042, 26589052, 26589062, 26589072, 26589082, 26589092, 26589102, 26589112, 26589122, 26589132, 26589142, 26589152, 26589162, 26589172, 26589182, 26589192, 26589202, 26589212, 26589222, 26589232, 26589242, 26589252, 26589262, 26589272, 26589282, 26589292, 26589302, 26589312, 26589322, 26589332, 26589342, 26589352, 26589362, 26589372, 26589382, 26589392, 26589402, 26589412, 26589422, 26589432, 26589442, 26589452, 26589462, 26589472, 26589482, 26589492, 26589502, 26589512, 26589522, 26589532, 26589542, 26589552, 26589562, 26589572, 26589582, 26589592, 26589602, 26589612, 26589622, 26589632, 26589642, 26589652, 26589662, 26589672, 26589682, 26589692, 26589702, 26589712, 26589722, 26589732, 26589742, 26589752, 26589762, 26589772, 26589782, 26589792, 26589802, 26589812, 26589822, 26589832, 26589842, 26589852, 26589862, 26589872, 26589882, 26589892, 26589902, 26589912, 26589922, 26589932, 26589942, 26589952, 26589962, 26589972, 26589982, 26589992, 26590002, 26590012, 26590022, 26590032, 26590042, 26590052, 26590062, 26590072, 26590082, 26590092, 26590102, 26590112, 26590122, 26590132, 26590142, 26590152, 26590162, 26590172, 26590182, 26590192, 26590202, 26590212, 26590222, 26590232, 26590242, 26590252, 26590262, 26590272, 26590282, 26590292, 26590302, 26590312, 26590322, 26590332, 26590342, 26590352, 26590362, 26590372, 26590382, 26590392, 26590402, 26590412, 26590422, 26590432, 26590442, 26590452, 26590462, 26590472, 26590482, 26590492, 26590502, 26590512, 26590522, 26590532, 26590542, 26590552, 26590562, 26590572, 26590582, 26590592, 26590602, 26590612, 26590622, 26590632, 26590642, 26590652, 26590662, 26590672, 26590682, 26590692, 26590702, 26590712, 26590722, 26590732, 26590742, 26590752, 26590762, 26590772, 26590782, 26590792, 26590802, 26590812, 26590822, 26590832, 26590842, 26590852, 26590862, 26590872, 26590882, 26590892, 26590902, 26590912, 26590922, 26590932, 26590942, 26590952, 26590962, 26590972, 26590982, 26590992, 26591002, 26591012, 26591022, 26591032, 26591042, 26591052, 26591062, 26591072, 26591082, 26591092, 26591102, 26591112, 26591122, 26591132, 26591142, 26591152, 26591162, 26591172, 26591182, 26591192, 26591202, 26591212, 26591222, 26591232, 26591242, 26591252, 26591262, 26591272, 26591282, 26591292, 26591302, 26591312, 26591322, 26591332, 26591342, 26591352, 26591362, 26591372, 26591382, 26591392, 26591402, 26591412, 26591422, 26591432, 26591442, 26591452, 26591462, 26591472, 26591482, 26591492, 26591502, 26591512, 26591522, 26591532, 26591542, 26591552, 26591562, 26591572, 26591582, 26591592, 26591602, 26591612, 26591622, 26591632, 26591642, 26591652, 26591662, 26591672, 26591682, 26591692, 26591702, 26591712, 26591722, 26591732, 26591742, 26591752, 26591762, 26591772, 26591782, 26591792, 26591802, 26591812, 26591822, 26591832, 26591842, 26591852, 26591862, 26591872, 26591882, 26591892, 26591902, 26591912, 26591922, 26591932, 26591942, 26591952, 26591962, 26591972, 26591982, 26591992, 26592002, 26592012, 26592022, 26592032, 26592042, 26592052, 26592062, 26592072, 26592082, 26592092, 26592102, 26592112, 26592122, 26592132, 26592142, 26592152, 26592162, 26592172, 26592182, 26592192, 26592202, 26592212, 26592222, 26592232, 26592242, 26592252, 26592262, 26592272, 26592282, 26592292, 26592302, 26592312, 26592322, 26592332, 26592342, 26592352, 26592362, 26592372, 26592382, 26592392, 26592402, 26592412, 26592422, 26592432, 26592442, 26592452, 26592462, 26592472, 26592482, 26592492, 26592502, 26592512, 26592522, 26592532, 26592542, 26592552, 26592562, 26592572, 26592582, 26592592, 26592602, 26592612, 26592622, 26592632, 26592642, 26592652, 26592662, 26592672, 26592682, 26592692, 26592702, 26592712, 26592722, 26592732, 26592742, 26592752, 26592762, 26592772, 26592782, 26592792, 26592802, 26592812, 26592822, 26592832, 26592842, 26592852, 26592862, 26592872, 26592882, 26592892, 26592902, 26592912, 26592922, 26592932, 26592942, 26592952, 26592962, 26592972, 26592982, 26592992, 26593002, 26593012, 26593022, 26593032, 26593042, 26593052, 26593062, 26593072, 26593082, 26593092, 26593102, 26593112, 26593122, 26593132, 26593142, 26593152, 26593162, 26593172, 26593182, 26593192, 26593202, 26593212, 26593222, 26593232, 26593242, 26593252, 26593262, 26593272, 26593282, 26593292, 26593302, 26593312, 26593322, 26593332, 26593342, 26593352, 26593362, 26593372, 26593382, 26593392, 26593402, 26593412, 26593422, 26593432, 26593442, 26593452, 26593462, 26593472, 26593482, 26593492, 26593502, 26593512, 26593522, 26593532, 26593542, 26593552, 26593562, 26593572, 26593582, 26593592, 26593602, 26593612, 26593622, 26593632, 26593642, 26593652, 26593662, 26593672, 26593682, 26593692, 26593702, 26593712, 26593722, 26593732, 26593742, 26593752, 26593762, 26593772, 26593782, 26593792, 26593802, 26593812, 26593822, 26593832, 26593842, 26593852, 26593862, 26593872, 26593882, 26593892, 26593902, 26593912, 26593922, 26593932, 26593942, 26593952, 26593962, 26593972, 26593982, 26593992, 26594002, 26594012, 26594022, 26594032, 26594042, 26594052, 26594062, 26594072, 26594082, 26594092, 26594102, 26594112, 26594122, 26594132, 26594142, 26594152, 26594162, 26594172, 26594182, 26594192, 26594202, 26594212, 26594222, 26594232, 26594242, 26594252, 26594262, 26594272, 26594282, 26594292, 26594302, 26594312, 26594322, 26594332, 26594342, 26594352, 26594362, 26594372, 26594382, 26594392, 26594402, 26594412, 26594422, 26594432, 26594442, 26594452, 26594462, 26594472, 26594482, 26594492, 26594502, 26594512, 26594522, 26594532, 26594542, 26594552, 26594562, 26594572, 26594582, 26594592, 26594602, 26594612, 26594622, 26594632, 26594642, 26594652, 26594662, 26594672, 26594682, 26594692, 26594702, 26594712, 26594722, 26594732, 26594742, 26594752, 26594762, 26594772, 26594782, 26594792, 26594802, 26594812, 26594822, 26594832, 26594842, 26594852, 26594862, 26594872, 26594882, 26594892, 26594902, 26594912, 26594922, 26594932, 26594942, 26594952, 26594962, 26594972, 26594982, 26594992, 26595002, 26595012, 26595022, 26595032, 26595042, 26595052, 26595062, 26595072, 26595082, 26595092, 26595102, 26595112, 26595122, 26595132, 26595142, 26595152, 26595162, 26595172, 26595182, 26595192, 26595202, 26595212, 26595222, 26595232, 26595242, 26595252, 26595262, 26595272, 26595282, 26595292, 26595302, 2659531

## CERTIFICATE

Power Grid Corporation of India Limited is the owner of the inter-state transmission project viz. "HVDC Bipole link between Western Region (Raigarh, Chattisgarh) and Southern Region (Pugalur, Tamil Nadu) – North Trichur (Kerala) – Scheme#1: Raigarh-Pugalur 6000 MW HVDC System", which was executed under Build, Own, Operate and Maintain (BOOM) scheme.

The first element of the above project was put under commercial operation w.e.f. 06-Sept-2020. This project is part of HVDC Transmission system.

The availability of HVDC system comprising all the HVDC systems of POWERGRID on PAN India basis is calculated by CTU based on outages certified by RPCs.

Availability of HVDC system calculated by CTU is a below:

Yearly Average Availability	
Period	Availability (in %)
	HVDC system
2020-21 (Sep 2020 – March 2021)	98.02
2021-22 (April 2021 – March 2022)	97.65
2022-23 (Apr'22-Dec'22)	98.25

For Power Grid Corporation of India Ltd.

  
 D. SUDHARSHAN  
 (Signature of Authorized Representative)  
 पावरग्रिड के.ए. / POWERGRID, CC

Date: 07/06/2023  
Place: Gurgaon



  
 ABHAY CHOUDHARY  
 Director (Projects)  
 POWERGRID



CERTIFIED AS TRUE



  
 SUDHARSHAN  
 Sr. General Manager (Finance)  
 पावरग्रिड के.ए. / POWERGRID, CC

268



## CERTIFICATE

Power Grid Corporation of India Limited is the owner of the inter-state transmission project viz. "HVDC Bipole link between Western Region (Raigarh, Chattisgarh) and Southern Region (Pugalur, Tamil Nadu) – North Trichur (Kerala) – Scheme#2: AC System Strengthening at Pugalur end", which was executed under Build, Own, Operate and Maintain (BOOM) scheme.

The above project was put under commercial operation w.e.f. 25-Oct-2021. This project is part of Southern Regional AC Transmission system.

The yearly average availability of Southern Regional AC Transmission system is calculated based on the monthly availability as certified by Southern Regional Power Committee (SRPC). Availability of SR Regional AC system since October 2021 is as below:

Yearly Average Transmission System Availability	
Period	Availability (in %)
2021-22 (Oct 2021 – Mar 2022)	Southern Region (regional) > 99
2022-23 (Apr'22-Feb'23)	> 99

For Power Grid Corporation of India Ltd.

Date: 07/06/2023  
Place: Gurgaon



  
**D. SUDHARSHAN**  
 (Signature of Authorized Representative (Finance))  
 पावरग्रिड के.आ. / POWERGRID, CC

  
**ABHAY CHOUDHARY**  
 Director (Projects)  
 POWERGRID

CERTIFIED AS TRUE

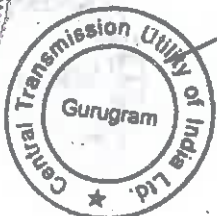

52



269



  
**D. SUDHARSHAN**  
 वरिष्ठ वित्तप्रबंधक (फिन)/Sr. General Manager (Finance)  
 पावरग्रिड के.आ. / POWERGRID, CC

## CERTIFICATE

Power Grid Corporation of India Limited is the owner of the inter-state transmission project viz. "HVDC Bipole link between Western Region (Raigarh, Chattisgarh) and Southern Region (Pugalur, Tamil Nadu)-North Trichur (Kerala)-Scheme#3: Pugalur-Trichur 2000 MW VSC based HVDC system", which was executed under Build, Own, Operate and Maintain (BOOM) scheme.

The first element of the above project was put under commercial operation w.e.f. 09-Mar-2021. This project is part of HVDC Transmission system.

The availability of HVDC system comprising all the HVDC systems of POWERGRID on PAN India basis is calculated by CTU based on outages certified by RPCs.

Availability of HVDC system calculated by CTU is as below:

Yearly Average Availability	
Period	Availability (in %)
	HVDC System
2020-21 (March 2021)	96.82
2021-22 (April 2021 - March 2022)	97.65
2022-23 (Apr'22-Dec'22)	98.25

For Power Grid Corporation of India Ltd.

डि. सुदर्शन  
D. SUDHARSHAN  
वरिष्ठ महासंचालक (वित्त)/Sr. General Manager (Finance)  
पावरग्रिड के.का./POWERGRID, CC

(Signature of Authorised Representative)

Date: 07/06/2023  
Place: Gurgaon



*Abhay Choudhary*  
ABHAY CHOUDHARY  
Director (Projects)  
POWERGRID

CERTIFIED AS TRUE



डि. सुदर्शन  
D. SUDHARSHAN  
वरिष्ठ महासंचालक (वित्त)/Sr. General Manager (Finance)  
पावरग्रिड के.का./POWERGRID, CC

270

## CERTIFICATE

Power Grid Corporation of India Limited is the owner of the inter-state transmission project viz. "Additional ATS for Tumkur (Pavagada) [Transmission System for Ultra Mega Solar Park at Tumkur (Pavagada), Karnataka-Phase II (Part-B)]", which was executed under Build, Own, Operate and Maintain (BOOM) scheme.

The above project was put under commercial operation w.e.f. 01-March-2021. This project is part of Southern Regional AC Transmission system.

The yearly average availability of Southern Regional AC Transmission system is calculated based on the monthly availability as certified by Southern Regional Power Committee (SRPC). Availability of SR Regional AC system since March 2021 is as below:

Yearly Average Transmission System Availability	
Period	Availability (in %)
2020-21 (01-Mar'21 - 31 <sup>st</sup> Mar'21)	Southern Region (regions)
2021-22 (Apr'21 - Mar'22)	> 99
2022-23 (Apr'22-Feb'23)	> 99
	> 99

For Power Grid Corporation of India Ltd.

  
 दि. सुदर्शन  
 D. SUDHARSHAN  
 सहायक वित्त (सि)/Sr. General Manager (Finance)  
 पावरग्रिड को.का. / POWERGRID, CC

(Signature of Authorised Representative)

Date: 07/06/2023  
Place: Gurugram



  
**ABHAY CHOUDHARY**  
 Director (Projects)  
 POWERGRID



CERTIFIED AS TRUE



  
 दि. सुदर्शन  
 D. SUDHARSHAN  
 सहायक वित्त (सि)/Sr. General Manager (Finance)  
 पावरग्रिड को.का. / POWERGRID, CC

271

Date: 19/06/23

**DISCLOSURE**

We hereby declare that the following companies with which we/ have direct or indirect relationship are also separately participating in this Bid process as per following details

S.No.	Name of the Company	Relationship
1.	NIL	

Further we confirm that we don't have any Conflict of Interest with any other company participating in this bid process.

Certified as true



(Signature)

डि. सुदर्शन  
D. SUDHARSHAN  
जूनियर जनरल मैनेजर (फिन्स)/Sr. General Manager (Finance)  
पावरग्रिड के.आ. / POWERGRID, CC

Name: D Sudharshan, Senior General Manager

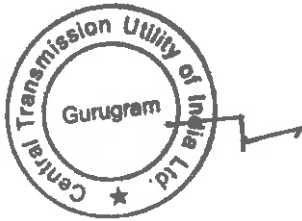

272

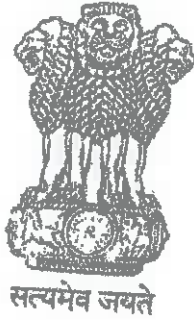

INDIA NON JUDICIAL

Government of National Capital Territory of Delhi

e-Stamp

Certificate No.	: IN-DLA4208578782547V
Certificate Issued Date	: 09-Jan-2023 11:25 AM
Account Reference	: IMPACC (IV) dl974203/ DELHI/ DL-DLH
Unique Doc. Reference	: SUBIN-DL DL97420382226982795008V
Purchased by	: POWER GRID CORPORATION OF INDIA LIMITED
Description of Document	: Article Others
Property Description	: Not Applicable
Consideration Price (Rs.)	: 0 (Zero)
First Party	: POWER GRID CORPORATION OF INDIA LIMITED
Second Party	: Not Applicable
Stamp Duty Paid By	: POWER GRID CORPORATION OF INDIA LIMITED
Stamp Duty Amount(Rs.)	: 100 (One Hundred only)

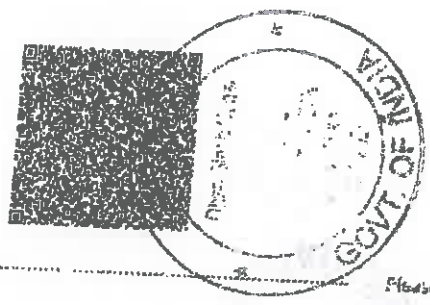

Please write or type below this line

**AFFIDAVIT**

We Power Grid Corporation of India Limited, hereby declare that as on Bid Deadline:

a. the Bidder & any of its Affiliate including any Consortium Member & any of its Affiliate, their directors or key personnel have not been barred or included in the blacklist by any government agency or authority in India, the government of the jurisdiction of the Bidder or Members where they are incorporated or the jurisdiction of their principal place of business, any international financial institution such as the World Bank, Asian Development Bank, African Development Bank, Inter-American Development Bank, Asian Infrastructure Investment Bank etc. or the United Nations or any of its agencies

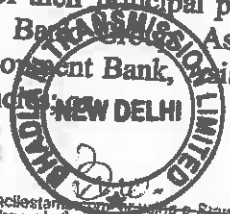
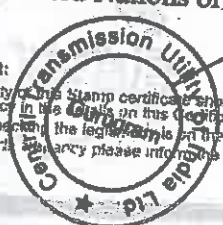

**Statutory Alert:**

- The authenticity of this stamp certificate should be verified at [www.theelectricalandpowersector.com](http://www.theelectricalandpowersector.com) or using e-Stamp Mobile App of State Government.
- Any discrepancy in the details on this certificate and as available on the website / Mobile App renders it invalid.
- The onus of checking the legal status on the users of the certificate.
- In case of any discrepancy please inform the Competent Authority.

273

D. SUCHARSHAN  
वरिष्ठ महासंचालक (वित्त) / Sr. General Manager (Finance)  
पावरग्रिड कं.का. / POWERGRID, CC

b. the Bidder & any of its Affiliate including any Consortium Member & any of its Affiliate or their directors have not been convicted of any offence in India or abroad.

We further declare that ~~following investigations are pending~~ / no investigation is pending against us or CEO or any of our directors/ manager/key managerial personnel of the Applicant /Consortium Member or their Affiliates

We further undertake to inform the BPC of any such matter as mentioned above on its occurrence after the date of this affidavit till the Effective Date.

We undertake that, in case, any information provided in relation to this affidavit is found incorrect at any time hereafter, our BID / Letter of Intent / contract (if entered) would stand rejected / recalled / terminated, as the case may be.

*[Handwritten signature]*

Signature and Name of the authorized signatory of the Company Bidding Company

D. SUDHARSHAN  
सीनियर मैनेजर (फिनांस) / Sr. General Manager (Finance)  
पावरग्रिड कंपनी. / POWERGRID, CC

(Signature of Notary Public)



Place: ..... New Delhi .....

Date: ..... 02/02/23 .....

ATTESTED  
NOTARY PUBLIC  
NEW DELHI (INDIA)

02 FEB 2023

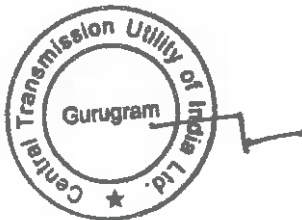

*[Handwritten signature]*



57

274



**UNDERTAKING AND DETAILS OF EQUITY INVESTMENT**

**Format 1: Bidders' Undertakings**

**Date:** .....19/06/23.....

To,

**PFC Consulting Limited  
9th Floor, Wing-A, Statesman House,  
Connaught Place, New Delhi - 110001**

Dear Sir,

**Sub: Bidders' Undertakings in respect of Bid for selection of Bidder as TSP to establish Inter-State transmission system for "Transmission system for evacuation of power from REZ in Rajasthan (20GW) under Phase-III Part B1 .**

We hereby undertake on our own behalf and on behalf of the TSP, that if selected as the Successful Bidder for the Project:

1. The Project shall comply with all the relevant electricity laws, codes, regulations, standards and Prudent Utility Practices, environment laws and relevant technical, operational and safety standards, and we shall execute any agreements that may be required to be executed as per law in this regard.
2. We confirm that the Project shall also comply with the standards and codes as per Clause 1.6.1.2 of the RFP and the TSP shall comply with the provisions contained in the Central Electricity Regulatory Commission Grant of Connectivity, Long-term Access and Medium-term Open Access in inter-state Transmission and related matters (Open Access) Regulations, 2009.
3. We give our unconditional acceptance to the RFP dated February 04, 2022 issued by the BPC and the RFP Project Documents, as amended, and undertake to ensure that the TSP shall execute all the RFP Project Documents, as per the provisions of this RFP.
4. We have submitted the Bid on the terms and conditions contained in the RFP and the RFP Project Documents. Further, the Financial Bid submitted by us is strictly as per the format provided in Annexure 21 of the RFP, without mentioning any deviations, conditions, assumptions or notes in the said Annexure.

Our Bid is valid up to the period required under Clause 2.8 of the RFP.

Our Bid has been duly signed by authorized signatory and stamped in the manner and to the extent indicated in this RFP and the power of attorney / Board resolution in requisite format as per RFP has been enclosed with this undertaking.

**डि. सुदर्शन**  
**D. SUDHARSHAN**

सिस्टम प्रशासक (विद्युत) / Sr. General Manager (Finance)  
पावरग्रिड के.का. / POWERGRID, CC

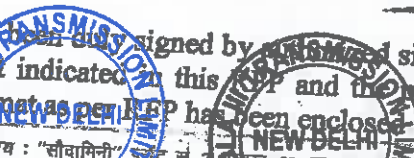

जोड़ित कार्यालय : बी-9, कृष्ण हस्तीदयशमल एनर्जी क्लस्टर, कानपुर, नई दिल्ली-110046  
Registered Office : B-9, Krishna Hastidayashamal Energy Cluster, Kanpur, New Delhi-110046

फोन : "सीवामिनी" - 26564812, 26564811, (हरियाणा), दूरभाष : 0124-2571700-719  
फोन : "Saudamini" - Plot No. 2, Sector-29, Gurgaon-122001, (Haryana) Tel. : 0124-2571700-719  
फोन : 10018, 10128, 10129, 10130, 10131, 10132, 26564812, 26564812, 26564892, सीआईएन : L40101DL1989GOI038121  
Website : www.powergridindia.com

275

7. [NOT APPLICABLE].

8. We confirm that our Bid meets the Scheduled COD of each transmission Element and the Project as specified below:

Sr. No	Name of the Transmission Element	Scheduled COD in months from Effective Date	Percentage of Quoted Transmission Charges recoverable on Scheduled COD of the Element of the Project	Element(s) which are pre-required for declaring the commercial operation (COD) of the respective Element
1.	<p>Establishment of 2x1500 MVA 765/400kV &amp; 3x500 MVA 400/220 kV pooling station at Bhadla-3 along with 2x330 MVar (765kV) Bus Reactor &amp; 2x125 MVar (420kV) Bus Reactor</p> <ul style="list-style-type: none"> <li>• 765/400kV 1500 MVA ICTs: 2 nos. (7x500 MVA including one spare unit)</li> <li>• 765kV ICT bays - 2 nos.</li> <li>• 400/220 kV, 500 MVA ICT - 3 nos.</li> <li>• 765kV line bays - 2 nos.</li> <li>• 400 kV ICT bays - 5 nos.</li> <li>• 220 kV ICT bays - 3 nos.</li> <li>• 220 kV line bays: 5 nos.</li> <li>• 330 MVar Bus Reactor-2 nos. (7x110 MVar, including one spare unit)</li> <li>• 765kV reactor bay - 2 nos.</li> <li>• 125 MVar, 420kV bus reactor - 2 nos.</li> <li>• 420 kV reactor bay - 2 nos.</li> </ul> <p>Future provisions: Space for</p> <ul style="list-style-type: none"> <li>• 765/400kV ICTs along with bays: 2 nos.</li> <li>• 765kV line bay along with switchable line reactor: 6 nos.</li> <li>• 765kV line bay: 4 nos.</li> <li>• 765kV Bus Reactor along with bays: 2 nos.</li> <li>• 400/220 kV ICTs along with bays: 10 nos.</li> <li>• 400 kV line bays: 8 nos.</li> <li>• 400 kV line bays along with switchable line reactor: 8 Nos.</li> <li>• 400kV Bus Reactor along with bays: 2 nos.</li> <li>• 400kV Sectionalization bay: 2 sets</li> <li>• 220kV line bays: 12 nos.</li> <li>• 220kV sectionalization bay: 2 sets</li> </ul>	18 Months	20.08%	<p>Elements marked at Sl. No. 1, 2 &amp; 3 are required to be commissioned simultaneously as their utilization is dependent on commissioning of each other.</p>

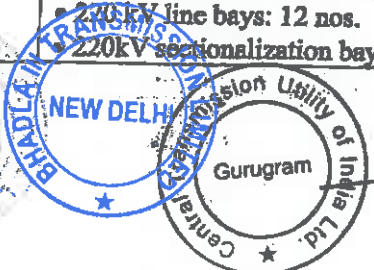

  
 दि. सुदर्शन  
 D. SUDHARSHAN  
 अधिक वित्तप्रबंधक (वित्त)/Sr. General Manager (Finance)  
 पावरग्रिड के.ए. / POWERGRID, CC

276

2.	Bhadla -3 PS – Sikar - II S/s 765 kV D/c line along with 330 MVAR Switchable line reactor for each circuit at each end of Bhadla -3 PS – Sikar -II S/s 765 kV D/c line • Switching equipment for 765 kV 330 MVAR switchable line reactor – 4 nos. • 765 kV, 330 MVAR Switchable line reactor - 4 nos.		78.16%	
3.	765 kV line bays at Sikar -II • 765 kV line bays – 2 nos.		1.76%	

We agree that the payment of Transmission Charges for any Element irrespective of its successful commissioning on or before its Scheduled COD shall only be considered after the successful commissioning of Element(s) which are pre - required for declaring the commercial operation of such Element as mentioned in the above table.

**Schedule COD for the Project: 18 Months from Effective Date.**

9. We confirm that our Financial Bid conforms to all the conditions mentioned in this RFP, and in particular, we confirm that:
  - a. Financial Bid in the prescribed format of Annexure 21 has been submitted duly signed by the authorized signatory.
  - b. Financial Bid is unconditional.
  - c. Only one Financial Bid has been submitted.
10. We have neither made any statement nor provided any information in this Bid, which to the best of our knowledge is materially inaccurate or misleading. Further, all the confirmations, declarations and representations made in our Bid are true and accurate. In case this is found to be incorrect after our acquisition of "BHADLA III TRANSMISSION LIMITED", pursuant to our selection as Selected Bidder, we agree that the same would be treated as a TSP's Event of Default under Transmission Service Agreement, and relevant provisions of Transmission Service Agreement shall apply.
11. We confirm that there are no litigations or other disputes against us which materially affect our ability to fulfill our obligations with regard to the Project as per the terms of RFP Project Documents.
12. Power of attorney/ Board resolution as per Clause 2.5.2 is enclosed.

(Signature)  
Name: \_\_\_\_\_

Sudharshan, Senior Manager

डि. सुदर्शन  
D. SUDHARSHAN  
सीनियर मैनजर (फिन्स) / Sr. General Manager (Finance)  
पावरग्रिड कं.का. / POWERGRID, CG



277

**Format 2: Details of equity investment in Project**

1.1.a Name of the Bidding Company: **Power Grid Corporation of India Limited**

1.2 Investment details of the Bidding Company/Member of the Bidding Consortium investing in **BHADLA III TRANSMISSION LIMITED**, as per Clause 2.5.8.2.

S. No.	Name of the Bidding Company/ Member in case of a Bidding Consortium	Name of the Company investing in the equity of the BHADLA III TRANSMISSION LIMITED	Relationship with Bidding Company /Member of the Bidding Consortium	% of equity participation in the BHADLA III TRANSMISSION LIMITED
(1)	(2)	(3)	(4)	(5)
1.	Power Grid Corporation of India Limited	Power Grid Corporation of India Limited	Self	100%
<b>TOTAL</b>				<b>100%</b>

Signature of authorized signatory

Name: **D Sudharshan**

Designation: **Senior General Manager**

Date: **19/6/23**

Company rubber stamp

**डि. सुदर्शन**  
**D. SUDHARSHAN**  
सीनियर जनरल मैनेजर (फिन्स)/Sr. General Manager (Finance)  
पावरग्रिड के.का./ POWERGRID, CC

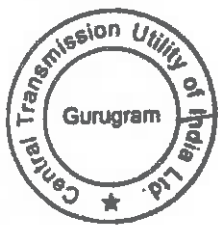

केन्द्रीय कार्यालय : "सौदामिनी" प्लॉट सं. 2, सेक्टर-29, गुरुग्राम-122001, (हरियाणा), दूरभाष : 0124-2571700-719  
Corporate Office : "Saudamini", Plot No. 2, Sector-29, Gurugram-122001, (Haryana) Tel. : 0124-2571700-719

जीकृत कार्यालय : बी-9, कुतुब इन्स्टीट्यूशनल एरिया, कटवारिया सराय, नई दिल्ली-110016 011-26560112, 26564812, 26564812, 26564892, सीआईएन : L40101DL1989GOI038121  
Registered Office : B-9, Qutab Institution Area, Katwaria Sarai, New Delhi-110016. Tel.: 011-26560112, 26564812, 26564812, 26564892, CIN : L40101DL1989GOI038121  
Website : www.powergridindia.com

278

# Proof of Payment of RFP Fees



*[Handwritten signature]*

**डि. सुदर्शन**  
**D. SUDHARSHAN**  
सीनियर मैनजरींग (फिन) / Sr. General Manager (Finance)  
पावरग्रिड को.का. / POWERGRID, GC

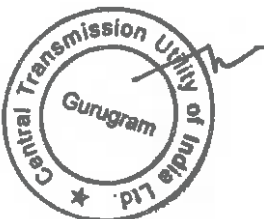

62 279

279

**SHREYANS JAIN (श्रेयांस जैन)**

**From:** Kaushal Kishor (काशाल किशोर)  
**Sent:** Tuesday, June 20, 2023 16:49  
**To:** SHREYANS JAIN (श्रेयांस जैन)  
**Subject:** FW: Payment towards purchase of RFP document Series XIII

**From:** SHREYANS JAIN (श्रेयांस जैन) <shreyans.jain@powergrid.in>  
**Sent:** Tuesday, February 22, 2022 11:10  
**To:** Project In-charge, ITP <pfcl.itp@pfclindia.com>; amitrawat.pfcl@gmail.com; kunalpfcl@gmail.com  
**Cc:** Sudharshan D (डी. सुदर्शन) <sudarshan@powergrid.in>; Mani Kumar (मणि कुमार) <manikumar@powergrid.in>  
**Subject:** Payment towards purchase of RFP document - Series XIII

Dear Sir,

Below is the payment detail towards purchase of RFP documents.

S. No.	Project Name	Payment amount	UTR No.
1	Transmission system for evacuation of power from REZ in Rajasthan (20GW) under Phase III Part B1	5,90,000.00	CMS2404282292 dated 17.02.2022
2	Transmission system for evacuation of power from REZ in Rajasthan (20 GW) under III -Part A1	5,90,000.00	CMS2404282293 dated 17.02.2022



3000  
1  
200

डि. सुदर्शन  
D. SUDHARSHAN  
श्रेयांस जैन (श्रेयांस जैन) Sr. General Manager (Finance)  
पावरग्रिड लि.का. / POWERGRID, CC





3	Transmission system for evacuation of power from REZ in Rajasthan (20GW) under Phase III Part A3	5,90,000.00	CMS2404282294 dated 17.02.2022
	<b>Total</b>	<b>17,70,000.00</b>	



→

डॉ. सुदर्शन  
D. SUDHARSHAN  
सीनियर मैनैजिंग (फिन) / सी. जनरल मैनेजर (फिनान्स)  
पावरग्रिड के डी. / POWERGRID, CC



Dr.

आवृत्त : यह ईमेल पावरग्रिड के जनरल मैनेजर द्वारा भेजा गया है और इसका अधिकार और शर्तें <http://www.powergrid.in/Discipline.html> पर दी गई हैं।  
Disclaimer: This e-mail is governed by the Discipline Terms & Conditions of POWERGRID which may be viewed at <http://www.powergrid.in/Discipline.html>

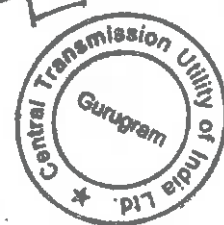

281



**STATE BANK OF INDIA**  
**CORPORATE ACCOUNTS GROUP BRANCH**  
**5<sup>TH</sup> FLOOR, RED FORT CAPITAL PARSVNATH TOWERS,**  
**BHAI VEER SINGH MARG, GOLE MARKET, NEW DELHI-110001**  
**BANK GUARANTEE NO.:1731323BG0000762 DATED 19.06.2023**

To,  
**PFC CONSULTING LTD**  
9th Floor, A-Wing, Statesman House,  
Connaught Place, New Delhi – 110001

**BANK GUARANTEE NUMBER: 1731323BG0000762 DATED 19.06.2023**  
**FOR RS. 40,00,00,000/- (RS. FORTY CRORE ONLY)**  
**VALID UPTO: 14.02.2024**  
**CLAIM UPTO: 13.02.2025**

In consideration of the M/s Power Grid Corporation of India Limited submitting the Bid inter alia for establishing the Inter-State transmission system for "Transmission system for evacuation of power from REZ in Rajasthan (20GW) under Phase-III Part B1" on build, own, operate and transfer basis, in response to the RFP dated February 04, 2022 issued by PFC Consulting Limited, and the Bid Process Coordinator (hereinafter referred to as BPC) agreeing to consider such Bid of M/s Power Grid Corporation of India Limited as per the terms of the RFP, the State Bank Of India, Corporate Accounts Group Branch, 5th Floor, Red Fort Capital Parsvnath Towers, Bhai Veer Singh Marg, Gole Market, New Delhi-110001, a bank constituted/registered under The SBI Act 1955 having our Corporate Centre at Madame Cama Road, Nariman Point, Mumbai (hereinafter referred to as "Guarantor Bank") hereby agrees unequivocally, irrevocably and unconditionally to pay to PFC Consulting Limited or its authorized representative at 9th Floor, A-Wing, Statesman House, Connaught Place, New Delhi – 110001 forthwith on demand in writing from PFC Consulting Limited or any representative authorized by it in this behalf, any amount up to and not exceeding Rupees Forty Crore Only (Rs. 40 Crore), on behalf of M/s Power Grid Corporation of India Limited.

This guarantee shall be valid and binding on the Guarantor Bank up to and including 14/02/2024 and shall not be terminable by notice or any change in the constitution of the Guarantor Bank or by any other reasons whatsoever and our liability hereunder shall not be impaired or discharged by any extension of time or variations or alternations made, given, or agreed with or without our knowledge or consent, by or between concerned parties.

Our liability under this Guarantee is restricted to Rupees Forty Crore Only (Rs. 40 Crore). Our Guarantee shall remain in force until 14.02.2024. PFC Consulting Limited or its authorized representative shall be entitled to invoke this Guarantee until 13.02.2025. The Guarantor Bank hereby expressly agrees that it shall not require any proof in addition to the written demand from PFC Consulting Limited or its authorized representative, made in any format, raised at the above mentioned address of the Guarantor Bank, in order to make the said payment to PFC Consulting Limited or its authorized representative.

The Guarantor Bank shall make payment hereunder on first demand without restriction or conditions and notwithstanding any objection, disputes, or disparities raised by the Bidder or any other person. The Guarantor Bank shall not require PFC Consulting Limited or its authorized representative to justify the invocation of this BANK GUARANTEE, nor shall the Guarantor Bank have any recourse against PFC Consulting Limited or its authorized representative in respect of any payment made hereunder.

This BANK GUARANTEE shall be interpreted in accordance with the laws of India.

The Guarantor Bank represents that this BANK GUARANTEE has been established in such form and with such content that it is fully enforceable in accordance with its terms as against the Guarantor Bank in the manner provided herein.

This BANK GUARANTEE shall not be affected in any manner by reason of merger, amalgamation, restructuring or any other change in the constitution of the Guarantor Bank.

 For STATE BANK OF INDIA  Manager (C.S.) Corporate Accounts Group Branch, New Delhi. AK-3876	 For STATE BANK OF INDIA  Deputy Manager (C.S.) Corporate Accounts Group Branch, New Delhi. 10855
 	



283

**STATE BANK OF INDIA**  
**CORPORATE ACCOUNTS GROUP BRANCH**  
**5<sup>TH</sup> FLOOR, RED FORT CAPITAL PARSVNATH TOWERS,**  
**BHAI VEER SINGH MARG, GOLE MARKET, NEW DELHI-110001**  
**BANK GUARANTEE NO.:1731323BG0000762 DATED 19.06.2023**

This BANK GUARANTEE shall be a primary obligation of the Guarantor Bank and accordingly PFC Consulting Limited or its authorized representative shall not be obliged before enforcing this BANK GUARANTEE to take any action in any court or arbitral proceedings against the Bidder, to make any claim against or any demand on the Bidder or to give any notice to the Bidder to enforce any security held by PFC Consulting Limited or its authorized representative or to exercise, levy or enforce any distress, diligence or other process against the Bidder.

Notwithstanding anything contained hereinabove, our liability under this Guarantee is restricted to Rupees Forty Crore Only (Rs. 40 Crore) and it shall remain in force until 14.02.2024 with an additional claim period of three hundred sixty five (365) days thereafter i.e. 13.02.2025. We are liable to pay the guaranteed amount or any part thereof under this BANK GUARANTEE only if PFC Consulting Limited or its authorized representative serves upon us a written claim or demand on or before 13.02.2025.

In witness whereof the Bank, through its authorized officer, has set its hand and stamp on this 19<sup>th</sup> day of June 2023 at New Delhi.

<p>For STATE BANK OF INDIA,                    Manager (C.S.)                  Corporate Accounts Group Branch, New Delhi.                  SAMEER KUMAR                  AK-3876</p>	<p>For STATE BANK OF INDIA,                    Deputy Manager (C.S.)                  Corporate Accounts Group Branch, New Delhi.                  MAYANK BHATNAGAR                  -10855</p>
--	--

Witness 1

VIVEKKUMAR *Vivek*  
 SBI CAO N.D

Witness 2

*Quinn*  
 VINMI ABROL  
 SBI CAO N.Delhi

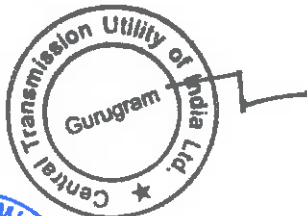

*Quinn*



284



STATE BANK OF INDIA  
 C.A.G. II NEW DELHI  
 4TH AND 5TH FLOOR  
 REDFORT  
 CAPITAL PARSVANATH  
 TOWERS, NEW DELHI

Tel No. :  
 Fax No. :  
 SWIFT No. : SBININBB824  
 PIN Code :

To,  
 PFC CONSULTING LTD  
 9TH FLOOR A WING STAESMAN HOUSE  
 CONNAUGHT PLACE NEW DELHI 110001

19-06-2023

DEAR SIR(S),

Guarantee Number	: 1731323BG0000762
Date of Issue	19-06-2023
Guarantee Amount	INR 400,000,000 00
Date of Expiry	14-02-2024
Date of Claim	13-02-2025
Applicant Name	POWER GRID CORPORATION OF INDIA LTD
E Stamp Certificate No.	
E Stamp Issuance Date & Time	
State of Execution	
Stamp Duty Type/Article No.	
Bank Guarantee Amount	INR 400,000,000 00
Amount of Stamp duty Paid	0 00
Issuing Bank Branch	
Bank Guarantee Beneficiary	PFC CONSULTING LTD

We confirm having issued / Extended the captioned Bank Guarantee in your favour on behalf of our above named Constituent and the same signed by the officers of the Bank.

YOURS FAITHFULLY,

AUTHORISED SIGNATORY - 1

\*AUTHORISED SIGNATORY - 2  
 (\*2nd signatory is for Rs. 50000/- and above)

Jun 19, 2023 6:02 PM

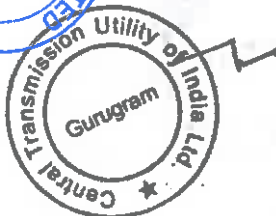

285

SWIFT

**A** Main Reference NO: 1731323BG0000762 Transaction Reference NO: 1731323BG0000762  
 Unit Code: 17313 Operator: 5146372  
 Module Name: BGIF Function Name: Inland\_Issue\_Bank\_Guarantee  
 Transaction Date: 19-06-2023 Transaction Time: 18:01:33  
 Event Time: 1

MT730COV ackFlag: notifyFlag

B1:

Outgoing SWIFT Header 1

B2:

F01SBIN001731350000000000

Receiver's BIC Code

I760ICIC0000007N

7020:

Transaction Reference Number (Issuing Bank Guarantee Number)

1731323BG0000762

7024:

Type of Bank Guarantee : Performance, Financial, Others

PERFORMANCE

7025:

Amount of Guarantee Currency Code Amount

7026:

Guarantee Validity Guarantee From Date Guarantee To Date

2023061920240214

7027:

Guarantee Effective Date

20230619

7029:

End date for lodgement of claim

20250213

7030:

Place of lodgement of claim

CORPORATE ACCOUNTS GROUP NEW DELHI

7031:

Issuing Branch IFSC

SBIN0017313

7032:

Issuing branch name and address

STATE BANK OF INDIA  
4TH AND 5TH FLOOR REDFORT  
GOLE MARKET

CAPITAL PARIVANATH TOWERS, NEW DELHI

7033:

Name of applicant and his details



286  
69



7034:

POWER GRID CORPORATION OF INDIA LTD  
SAUDIMINI PLOT NO 2  
SECTOR 29  
GURGAON INDIA

**Name of Beneficiary and his details**

7035:

PFC CONSULTING LTD  
9TH FLOOR A WING STAESMAN HOUSE  
CONNAUGHT PLACE NEW DELHI 110001

**Beneficiary IFSC**

7036:

ICIC0000007

**Beneficiary branch name and address**

7040:

ICICI BANK LTD  
NEW DELHI - CONNAUGHT PLACE  
9A, PHELPS BUILDING, CONEE CIR  
NEW DELHI

**Stamp Duty Electronically Paid (Y/N)**

7046:

**Date of Payment**

7047:

20230619

**Place of Payment**

7048:

C.A.G. II NEW DELHI

**e-Bank Guarantee to be held in Demat Form(Y/N)**

20Z:

N

**Transaction Reference Number**

NON-REGULAR

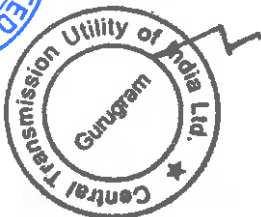

*310..*

### Checklist for Technical Bid Submission Requirements

Technical Bid Submission Requirements	Response (Yes / No)
1. Format for the Covering Letter on the letterhead of Bidding Company or Lead Member of the Consortium, as applicable;	Yes
2. Format for Letter of Consent from each Consortium Member, including Lead Member, on their respective letterheads;	No
3. Format for evidence of authorized signatory's authority ;	Yes
4. Board resolution from the Bidding Company / Lead Member of the Consortium in favour of the person executing the Power of Attorney as per Annexure 3;	Yes
5. Power of Attorney from each Consortium Member in favour of Lead Member to be provided by each of the other Members of the Consortium as per Annexure 4;	No
6. Board Resolution from each Member of the Consortium, other than the Lead Member, in favour of their respective authorized representatives for executing the POA, Consortium Agreement and signing of the requisite formats;	No
7. Format for Bidder's composition and ownership structure, along with status of equity holding (owning ten percent or more of the total paid up equity) not earlier than thirty (30) days prior to the Bid Deadline as per Annexure 5;	Yes
8. Consortium Agreement duly signed as per Annexure 6, along with Appendix-1, indicating the responsibilities and obligations of each Member of the Consortium;	No
9. Format for Qualification Requirement:	Yes
a. Calculation sheets, detailing computation of Networth considered for meeting Qualifying Requirements, duly signed and stamped by the Statutory Auditor of the Bidding Company / each Member in case of a Bidding Consortium / FEE in cases where credentials of FEE is taken;	Yes
b. Calculation sheets, detailing computation of capital expenditure of projects and revenue received in construction projects considered for meeting Qualification Requirements, duly signed and stamped by the Statutory Auditor of the Bidding Company /★	Yes



3/10  
 दि. सुदर्शन  
 D. SUDHARSHAN  
 वरिष्ठ वित्त प्रबंधक (फिन्स)/Sr. General Manager (Finance)  
 पावरग्रिड को.ल. / POWERGRID, CC

Technical Bid Submission Requirements	Response (Yes / No)
Lead Member in case of Bidding Consortium / TEE in cases where credentials of TEE is taken;	
c. Last financial year unconsolidated / consolidated audited annual accounts / statements, as the case may be, of the Financially Evaluated Entity / Technical Evaluated Entity	Yes
d. Unconsolidated audited annual accounts of both the TEE and the Bidding Company/Lead member, as applicable, from the financial years in which financial closure was achieved till the financial year in which the said project was completed / commissioned.	Yes
10. Copy of the Memorandum and Articles of Association and certificate of incorporation or other organizational document (as applicable), including their amendments, certified by the Company Secretary of Bidding Company or each Member in case of a Consortium including Lead Member.	Yes
11. Attachment of Annexure 7(D), detailing projects completed / commissioned and for which commercial operation has commenced including Executive Summary for each project.	Yes
12. For each project listed in the attachment above, certified true copy of the certificates of final acceptance and / or certificates of good operating performance duly issued by owners or clients for the project, duly signed by authorized signatory in support of technical capability as defined in Clause 2.1.2 of RFP.	Yes
13. Authority letter in favour of BPC from the Bidder/every Member of the Consortium authorizing the BPC to seek reference from their respective bankers & others.	Yes
14. Authorization from Parent / Affiliate of Bidding Company / Member of Bidding Consortium whose technical / financial capability has been used by the Bidding Company / Member of Bidding Consortium.	No
15. Initialing of all pages of Technical Bid by the Authorized Signatory in whose favour the POA (Annexure 3) has been executed.	Yes
Format for Illustration of Affiliates at the most seven (7) days prior to the Bid Deadline, duly certified by Company Secretary and supported by documentary evidence.	No
Certified copy of the Register of Members / Demat Account Statement, Share Certificate and Annual Return filed with ROC	No

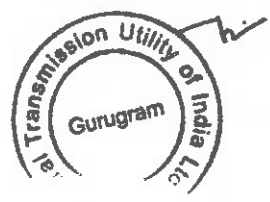
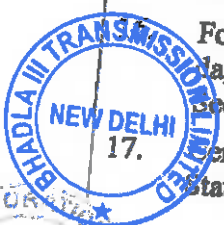

दि. सुदर्शन  
 D. SUDHARSHAN  
 वरिष्ठ वित्त प्रबंधक (वित्त) / Sr. General Manager (Finance)  
 पावरग्रिड कॉर्पोरेशन ऑफ इंडिया लि. / POWERGRID, CC

Technical Bid Submission Requirements	Response (Yes / No)
etc. submitted as documentary evidence along with Annexure 12.	
18. Format for Disclosure by Bidding Company / each Member of the Consortium.	Yes
19. Format for Affidavit by the Bidding Company / each Member of the Consortium	Yes
20. Format for Authorization submitted in Non-Judicial stamp paper duly notarized.	Yes
21. Bidders Undertaking and details of Equity Investment	Yes
22. Proof of Payment of RFP Fees	Yes
23. Bid Bond/ <del>Bid Security Declaration</del> (As applicable)	Yes
24. Board Resolution as per Annexure 11 (If required)	Yes

For and on behalf of Bidder

*M/s. Power Grid Corporation of India Limited*

*[Handwritten Signature]*

.....  
(Signature of authorized signatory)

डि. सुदर्शन  
D. SUDHARSHAN  
सीनियर मैनेजर (फिन्स)/Sr. General Manager (Finance)  
पावरग्रिड कॉ. लि. / POWERGRID, CC

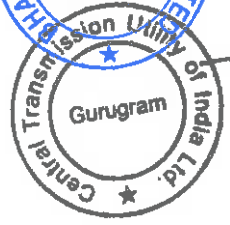

*[Handwritten Signature]*



290



पावर ग्रिड कॉर्पोरेशन ऑफ इंडिया लिमिटेड  
 (भारत सरकार का उद्योग)  
**POWER GRID CORPORATION OF INDIA LIMITED**  
 (A Government of India Enterprise)

Details as sought under 'Common Terms' on MSTC Portal

Sl.No	Bidder's Profile	
1	Name of the Bidding company	POWER GRID CORPORATION OF INDIA LIMITED
2	Address of the Bidding company	Regd office : B-9, Qutab Institutional Area, Katwaria Sarai, New Delhi 110016  Corp Office : Saudamini, Plot no. 2, Sector 29, Gurgaon 122001, Haryana
3	Contact Person(Authorised Signatory)	D Sudharshan
4	Telephone Number	0124-2822093
5	Mobile Number	9449599097
6	Email Address for correspondence	tbc@powergrid.co.in
7	PAN of the Bidding Company	<p>शुद्धि कर संख्या / PERMANENT ACCOUNT NUMBER AAACP8282G</p> <p>कंपनी का नाम POWER GRID CORPORATION OF INDIA LTD</p> <p>स्थापना की तिथि / DATE OF INCORPORATION/FORMATION 23-10-1989</p> <p><i>D. Sudharshan</i>          अध्यक्ष प्रणाली (वित्त)          DIRECTOR OF INCOME TAX (SYSTEMS)</p>

Signature of Authorized Signatory

*D. Sudharshan*  
**डि. सुदर्शन**  
**D. SUDHARSHAN**  
 वरिष्ठ प्रमुख वित्त (वित्त)/Sr. General Manager (Finance)  
 पावरग्रिड के.का./ POWERGRID, CC

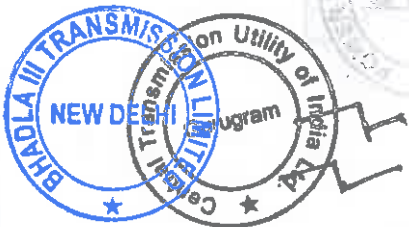

केन्द्रीय कार्यालय "सौदामिनी" प्लॉट सं. 2, सेक्टर 29, गुरुग्राम-122001 (हरियाणा), दूरभाष : 0124-2571700-719  
 Corporate Office : "Saudamini", Plot No. 2, Sector 29, Gurugram-122001 (Haryana) Tel. : 0124-2571700-719

पंजीकृत कार्यालय : बी-9, कुतब इंस्टीट्यूशनल एरिया, कटवारिया सराय, नई दिल्ली-110016. टेलीफोन : 011-26560112, 26564812, 26564892, सीआईएन : L40101DL1989GOI038121  
 Registered Office : B-9, Qutab Institutional Area, Katwaria Sarai, New Delhi-110016. Tel. : 011-26560112, 26564812, 26564892, CIN : L40101DL1989GOI038121  
 Website : www.powergridindia.com

74

2a

Ref. No. 04/22-23/ITP-49/RfP

June 06, 2023

To,  
Mr. Pankaj Pandey, CGM (TBCB)  
M/s Power Grid Corporation of India Limited,  
"Saudamini" Plot No 2, Sector 29,  
Gurgaon-122001

E-mail: [ppandey@powergrid.in](mailto:ppandey@powergrid.in)

**Subject: Independent Transmission Project "Transmission system for evacuation of power from REZ in Rajasthan (20GW) under Phase-III Part B1" – Regarding revised Estimated Acquisition Price.**

Ref.: PFCCCL Letter No. 04/21-22/ITP-49/RfP dated 18.08.2022.

Dear Sir,

This has reference to the PFCCCL letter dated 18.08.2022 intimating the estimated acquisition Price for the subject project. In this regard, the following may be noted in respect of revised acquisition price.

"The revised estimated Acquisition Price payable by the selected Bidder to the PFC Consulting Limited for the acquisition of one hundred percent (100%) of the equity shareholding of 'BHADLA III TRANSMISSION LIMITED', along with all its related assets and liabilities is **Rs.20,11,16,595/- (Rupees Twenty Crore Eleven Lakh Sixteen Thousand Five Hundred Ninety Five Only).**"

This is for your information and further action please.

Thanking you,

Yours faithfully,



(Sanjay Nayak)  
General Manager





Ref. No. 04/22-23/ITP-49/RFP

September 18, 2023

Power Grid Corporation of India Limited  
'Saudamini' Plot No 2, Sector- 29,  
Gurgaon – 122001 (Haryana)

E-mail: [sudarshan@powergrid.in](mailto:sudarshan@powergrid.in)

Kind Attn.: Mr. D. Sudharshan, Senior General Manager, Authorized Signatory

Subject: Independent Transmission Project (ITP) "Transmission System for evacuation of power from REZ in Rajasthan (20 GW) under Phase-III Part B1" – Regarding Transfer of SPV "Bhadla III Transmission Limited".

Ref: 1. Letter of Intent (LoI) no. 04/22-23/ITP-49/RFP dated July 28, 2023.  
2. PFCCL letter no. 04/22-23/ITP-49/RFP dated September 12, 2023.

Dear Sir,

In line with the provision of Clause 2.15.2 (c) of the RFP Document, one hundred per cent (100%) equity shareholding of the SPV namely, "Bhadla III Transmission Limited" is to be acquired by the selected bidder along with all its related assets and liabilities for an Acquisition Price.

Further, it is to intimate that PFCCL vide its letter dated September 12, 2023 has informed to submit the Contract Performance Guarantee which is still awaited. The Acquisition Price of the SPV Bhadla III Transmission Limited is Rs.20,11,16,595/- (Rupees Twenty Crore Eleven Lakh Sixteen Thousand Five Hundred Ninety Five Only). The break-up for this amount is given below:

S. No.	Description	Amount (in INR)
1.	PFCCL Management Fees	15,00,00,000
2.	Goods and Service Tax on PFCCL Management Fees	2,70,00,000
3.	Other Administrative Expenses	2,40,16,595
4.	Share Capital	1,00,000
	<b>Total</b>	<b>20,11,16,595</b>

The payment of the Acquisition Price may be made as detailed hereunder:

Name : PFC Consulting Limited  
PFCCL Goods and Service Tax No. : 07AAECP6182F1ZC  
PFCCL PAN No. : AAEC6182F  
Mode of Payment : RTGS

Bank Details:

Bank Name	ICICI Bank, 9A, Phelps, Connaught Place, New Delhi-110001
Name of Account	PFC CONSULTING LIMITED
A/C No.	000705036117
IFSC Code	ICIC0000007



पंजीकृत कार्यालय : प्रथम तल "ऊर्जानिधि", 1, बाराखम्बा लेन, कर्नाट प्लेस, नई दिल्ली-110001

Regd. Office : First Floor, "Urjanidhi", 1, Barakhamba Lane, Connaught Place, New Delhi-110001

कंपनी मुख्यालय: चौथी तल (ए विंग) स्टेट्समैन हाउस, कर्नाट प्लेस, नई दिल्ली-110001 दूरभाष : 011-23443900 फैक्स : 011-23443990  
Corporate Office : 9th Floor, (A Wing) Statesman House, Connaught Place, New Delhi-110001 Phone : 011-23443900 Fax : 011-23443990  
वेबसाइट/Website : [www.pfcclindia.com](http://www.pfcclindia.com) • CIN : U74140DL2008GOI175858

It is requested that TDS may be deducted against the above payment as per I.T. rules. Copy of PAN Card and Cheque of the above bank are enclosed herewith.

The SPV is proposed to be transferred tentatively on 22.09.2023. Therefore, it is requested to make the above payment as per the details provided above through RTGS at the earliest.

Further, it is once again requested to provide the Contract Performance Guarantee (CPG) in favour of Nodal Agency i.e. Central Transmission Utility of India Limited (CTUIL) as per the details provided in RFP and subsequent amendments issued.

With kind regards,

Yours sincerely



(Sanjay Nayak)

General Manager

Attested from Pg. 294 to 296  
**ATTESTED TRUE COPY**



Authorized Signatory

**BHADLA III TRANSMISSION LIMITED**



294



295

**ICICI Bank**  
New Delhi Branch  
9A, Pheps, Connaught Place, NEW DELHI - 110001.  
RTGS / NEFT IFSC Code : ICIC0000007

*PRIVILEGE*

VALID FOR THREE MONTHS ONLY

A/C PAYEE

\_\_\_\_\_|\_\_\_\_\_|\_\_\_\_\_|\_\_\_\_\_|\_\_\_\_\_|\_\_\_\_\_|  
D O M M Y Y Y Y

Pay

OR ORDER

Rupees

₹

A/c No.

000705036117

FOR PFC CONSULTING LIMITED

CABUS CBS  
BUSINESS BANKING - CURRENT ACCOUNT  
Payable at par at all branches of ICICI Bank Limited in India

AUTHORISED SIGNATORIES

⑈346908⑈ 110229002⑈ 036117⑈ 29



296

Dated 27<sup>th</sup> SEPTEMBER, 2023

**SHARE PURCHASE AGREEMENT**

**BETWEEN**

**PFC CONSULTING LIMITED**

**AND**

**BHADLA III TRANSMISSION LIMITED**

**AND**

**POWER GRID CORPORATION OF INDIA LIMITED**

Attested from Pg 297 to 313

**ATTESTED TRUE COPY**

Authorised Signatory  
**BHADLA III TRANSMISSION LIMITED**

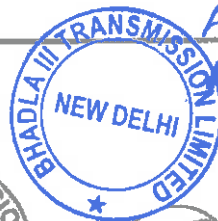

297

## INDIA NON JUDICIAL



## Government of National Capital Territory of Delhi

e-Stamp

Certificate No. : IN-DL72218379574755V  
 Certificate Issued Date : 26-Sep-2023 12:42 PM  
 Account Reference : IMPACC (IV) d1960303/ DELHI/ DL-DLH  
 Unique Doc. Reference : SUBIN-DL DL96030310566805562856V  
 Purchased by : PFC CONSULTING LIMITED  
 Description of Document : Article 5 General Agreement  
 Property Description : Not Applicable  
 Consideration Price (Rs.) : 0  
 (Zero)  
 First Party : PFC CONSULTING LIMITED  
 Second Party : Not Applicable  
 Stamp Duty Paid By : PFC CONSULTING LIMITED  
 Stamp Duty Amount (Rs.) : 100  
 (One Hundred only)

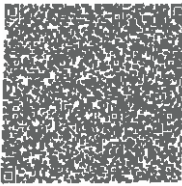

Please write or type below this line

## SHARE PURCHASE AGREEMENT

This SHARE PURCHASE AGREEMENT ('Agreement') made this 27<sup>th</sup> Day of September 2023 at New Delhi by and between:

**PFC CONSULTING LIMITED** (a wholly owned subsidiary of Power Finance Corporation Ltd.), a company incorporated under the Companies Act, 1956, with CIN No. U74140DL2008GOI175858 having its registered office at First Floor, "Urjanidhi", 1 Barakhamba Lane, Connaught Place, New Delhi 110001, (hereinafter referred to as "PFCCL", which expression shall, unless it be repugnant to the context or meaning thereof, be deemed to mean and include its successors and permitted assigns) of the FIRST PART

Statutory

1. The authenticity of this Stamp certificate should be verified at [www.e-stamp.gov.in](http://www.e-stamp.gov.in) or using e-Stamp Mobile App for Holding. Any discrepancy in the details on this Certificate and as available on the website / Mobile App renders it invalid.

2. The onus of checking the legitimacy is on the users of the certificate.

3. In case of any discrepancy please inform the Competent Authority.



298



AND

**BHADLA III TRANSMISSION LIMITED**, a company incorporated under the Companies Act, 2013, with CIN No. U74999DL2022GOI399208 having its registered office at First Floor, "Urjanidhi", 1 Barakhamba Lane, Connaught Place, New Delhi 110001, (hereinafter referred to as "Company" which expression shall, unless repugnant to the context or meaning thereof, be deemed to mean and include its successors and permitted assigns) of the **SECOND PART**; and

AND

**POWER GRID CORPORATION OF INDIA LIMITED**, a company incorporated under the Companies Act, 1956 with CIN No. L40101DL1989GOI038121 having its registered office at B-9, Qutab Institutional Area, Katwaria Sarai, New Delhi-110016 (hereinafter referred to as "Selected Bidder" which expression shall, unless repugnant to the context or meaning thereof, be deemed to mean and include its successors and permitted assigns) of the **THIRD PART**.

**WHEREAS:**

- A. The Ministry of Power, Government of India, vide its Gazette no. **CG-DL-E-08122021-231686** dated **December 06, 2021** has notified PFC Consulting Ltd. to be the Bid Process Coordinator (BPC) for the purpose of selection of Bidder as Transmission Service Provider (TSP) to establish transmission system for "Transmission system for evacuation of power from REZ in Rajasthan (20 GW) under phase III –Part-B1" through tariff based competitive bidding process (hereinafter referred to as the "Project").
- B. In accordance with the Bidding Guidelines, PFCCL had initiated a Bid Process through issuance of RFP documents for selecting a Successful Bidder to build, own, operate and transfer the Project in accordance with and on the terms and conditions mentioned in the RFP Project Documents (as defined hereinafter).
- C. PFCCL has incorporated the Company and PFCCL along with the Nominees hold One hundred per cent (100 %) of total issued and paid up equity share capital of the Company.
- D. PFCCL has initiated the development of the Project and has obtained survey report, certain clearances, consents and permits as specified in the RFP regarding the Project.
- E. Pursuant to the said Bid Process, Power Grid Corporation Of India Limited has been identified as the Selected Bidder vide Letter of Intent dated July 28, 2023 issued by the PFCCL in favor of the Selected Bidder.
- F. As envisaged in the RFP, the Shares Seller (as defined hereinafter) has agreed to sell the Sale Shares (as defined hereinafter) to the Selected Bidder and the Selected Bidder has agreed to purchase the Sale Shares from the Shares Seller, subject to and on the terms and conditions set forth in this Agreement.

**NOW THEREFORE, IN CONSIDERATION OF THE MUTUAL COVENANTS AND AGREEMENTS SET FORTH IN THIS AGREEMENT AND FOR OTHER GOOD AND VALUABLE CONSIDERATION, THE PARTIES HEREBY AGREE AS FOLLOWS:**

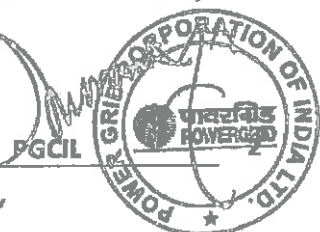
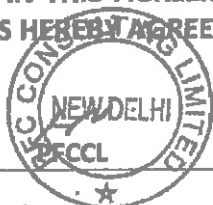

259

1. DEFINITIONS

1.1 Capitalised terms in this Agreement, unless defined in this Agreement shall, in so far as the context admits, have the same meaning in this Agreement as has been ascribed to them in the Transmission Service Agreement.

1.2 Additionally, the following terms shall have the meaning hereinafter respectively assigned to them herein below:

- (i) **"Acquisition Price"** shall mean **INR 20,11,16,595 (Rupees Twenty Crore Eleven Lakh Sixteen Thousand Five Hundred Ninety Five only)** [Insert the value of the Acquisition Price, both in figures and in words respectively], which is the aggregate consideration payable by the Selected Bidder towards purchase of the Sale Shares at par along with assets and liabilities of the Company as on the Closing Date subject to adjustment as per the audited accounts of the Company as on the Closing Date;
- (ii) **"Agreement"** or **"the Agreement"** or **"this Agreement"** shall mean this Share Purchase Agreement and shall include the recitals and/or annexures attached hereto, and the contracts, certificates, disclosures and other documents to be executed and delivered pursuant hereto, if any, and any amendments made to this Agreement by Parties in writing;
- (iii) **"Bid Process"** shall mean the competitive bidding process initiated by the Company, by issuance of RFP Documents for selecting a Successful Bidder to build, own, operate and transfer the Project in accordance with and on the terms and conditions mentioned in the RFP Project Documents;
- (iv) **"Board"** shall mean the board of directors of the Company
- (v) **"Closing Date"** shall mean a mutually agreed date between the Parties falling within the period as mentioned in Clause 2.4 of RFP or on failure of such mutual agreement between the Parties shall be the date falling on the last date of such period;
- (vi) **"CTU"** or **"Central Transmission Utility of India Limited"** shall have same meaning as defined in the Electricity Act, 2003;
- (vii) **"Encumbrance"** shall mean any mortgage, pledge, lien, charge, security assignment, hypothecation, trust, encumbrance or any other agreement having the effect of creating security interest;
- (viii) **"Letter of Intent"** shall have the meaning ascribed thereto under the RFP;
- (ix) **"Nominees"** shall mean the Persons, who are named in Annexure A, holding the Sale Shares as nominees of PFCCCL.



- (x) "Party" shall mean PFCCL, Company and the Selected Bidder, referred to individually, and "Parties" shall mean PFCCL, Company and the Selected Bidder collectively referred to, as relevant;
- (xi) "Person" shall include an individual, an association, a corporation, a partnership, a joint venture, a trust, an unincorporated organisation, a joint stock company or other entity or organisation, including a government or political subdivision, or an agency or instrumentality thereof, and/or any other legal entity;
- (xii) "RfP Project Documents" shall mean the following documents, referred to collectively:
- Transmission Services Agreement;
  - this Agreement; and
  - Any other agreement(s) as may be required.
- (xiii) "Representations and Warranties" shall mean the representations and warranties mentioned in Clause 4 hereto;
- (xiv) "Sale Shares" shall mean 10,000 (Ten Thousand) Shares, representing 100 percent of the total issued, subscribed and fully paid-up equity share capital of the Company held by the Shares Seller and Nominees as more particularly described in Annexure A attached hereto;
- (xv) "Shares" shall mean the fully paid-up equity shares of Company, of face value Rs. 10 each;
- (xvi) "Shares Seller" shall mean PFCCL;
- (xvii) "Transmission Services Agreement" or "TSA" means the agreement titled 'Transmission Services Agreement' dated September 27, 2023 entered into between Central Transmission Utility of India Limited and the TSP pursuant to which the TSP shall build, own, operate and transfer the Project and make available the assets of the Project to Central Transmission Utility of India Limited on a commercial basis, as may be amended from time to time;
- (xviii) "Transmission Service Provider" or "TSP" shall mean SPV [which is under incorporation] which has executed the Transmission Service Agreement and which shall be acquired by the Selected Bidder.

### 1.3 Interpretation Clause

Unless the context otherwise requires, the provisions of the TSA relating to the interpretation of the TSA shall apply to this Agreement as if they were set out in full in this Agreement and to this end are incorporated herein by reference.

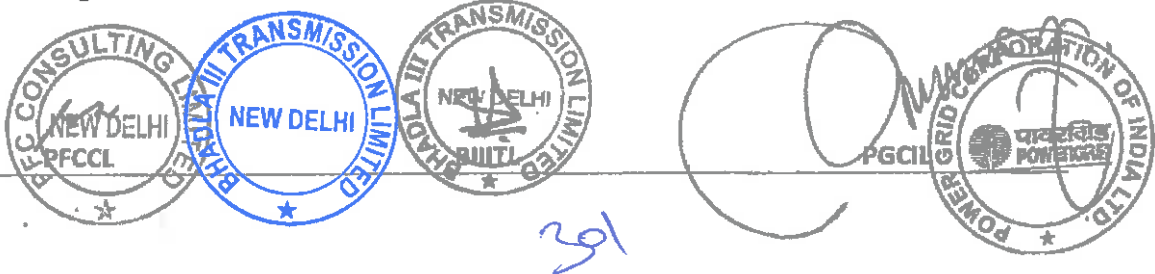

**2. TRANSFER OF SHARES**

- 2.1 Subject to the terms and conditions of this Agreement, the Shares Seller agrees to sell and transfer to the Selected Bidder and the Selected Bidder hereby agrees to purchase from the Shares Seller, the Sale Shares of the Company free from Encumbrances with rights and benefits attached thereto in consideration of the Acquisition Price and the covenants, undertakings and the agreements of the Selected Bidder contained in this Agreement.
- 2.2 The Shares Seller hereby undertakes to cause the Nominees to transfer part of the Sale Shares held by them as Nominees of the Shares Seller to the Selected Bidder and execute any documents required to deliver good title to the Sale Shares to the Selected Bidder.

**3. CLOSING**

- 3.1 Prior to the Closing Date, the Selected Bidder shall provide to the Shares Seller, valid share transfer forms ("Share Transfer Forms") duly stamped with requisite amount of stamp duty payable on the transfer of Sale Shares.
- 3.2 On the Closing Date, the Shares Seller shall hand over to the Selected Bidder or its authorised representative, the original share certificates representing the Sale Shares ("Sale Share Certificates") along with the Share Transfer Forms duly executed by the Shares Seller and the Nominees in favour of the Selected Bidder, simultaneously against the Selected Bidder handing over to the Shares Seller demand drafts drawn in favour of the Shares Seller for the Acquisition Price payable to it.

Provided that prior to the handing over of the Sale Share Certificates to the Selected Bidder as mentioned above, the Selected Bidder shall provide satisfactory evidence to PFCCIL that on or before the Closing Date, the Selected Bidder has furnished the Performance Bank Guarantee to Central Transmission Utility of India Limited and is in a position to comply with all other requirements of Clause 2.4 of the RFP.

- 3.3 The Selected Bidder shall immediately upon receiving the Sale Share Certificates and the Share Transfer Forms, duly execute the Share Transfer Forms and duly lodge the Share Transfer Forms and the Sale Share Certificates with the Company. The Selected Bidder may also propose the names of its nominees to be appointed on the Board of the Company and the address within the jurisdiction of the Registrar of Delhi and Haryana, which would be the new registered office of the Company. The Company shall, upon receipt of the said documents from the Selected Bidder, do the following:

- (i) Immediately on the Closing Date convene a meeting of the Board, wherein the Board shall pass the following necessary resolutions:

- (a) approving the transfer of the Shares constituting the Sale Shares from the Shares Seller and its Nominees to the name of the Power Grid Corporation Of India Limited and its nominees;

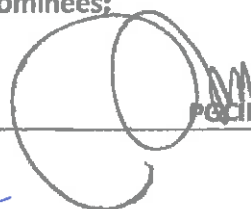

- (b) approving the **Power Grid Corporation Of India Limited** and its Nominees as mentioned hereinabove in clause 3.3 (i) (a) as a member of the Company and entering the name of the **Power Grid Corporation Of India Limited** and its nominees in the register of members.
- (c) changing the address of the registered office of the Company to the new address, within the jurisdiction of the Registrar of Delhi and Haryana, as may be provided by the Selected Bidder.
- (d) appointing the nominees of the Selected Bidder on the Board and accepting the resignations of the other existing Directors on the Board and the Chair of the meeting which was taken by one of the existing Directors shall be vacated and appointment of a new Chairman who shall be one of the newly appointed Director, for the rest of the meeting.

Immediately pursuant to the acceptance of resignation of the existing Directors and appointment of new Chairman, the newly constituted Board of Directors shall continue with the meeting and pass the following resolution:

- (e) terminating all the authorizations granted regarding the business and/or operations of the Company or the operations of the bank accounts of the Company, with prospective effect; and
  - (f) acknowledging and accepting the terms and conditions as contained in the executed copies of the RFP Project Documents and to abide by the provisions contained therein.
- (ii) Enter the name of the **Power Grid Corporation Of India Limited** and its nominees as the legal and beneficial owner of the Sale Shares, free of all Encumbrances, in the register of members of the Company;
  - (iii) Make the necessary endorsements on the Sale Share Certificates, indicating the name of the **Power Grid Corporation Of India Limited** and its nominees as the legal and beneficial owner of the Sale Shares evidenced there under;
  - (iv) Return the original Sale Share Certificates, duly endorsed in the name of the **Power Grid Corporation Of India Limited** and its nominees, to the **Power Grid Corporation Of India Limited** and its nominees, as the case may be or its authorised representative;
  - (v) Handover all the statutory registers and records, if any, of the Company to the Selected Bidder.
  - (vi) Handover certified true copies of the Board resolution passed by the Company as per (i)(a) to (i)(e) of Clause 3.3 (i) to Central Transmission Utility of India Limited.

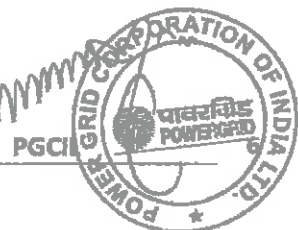
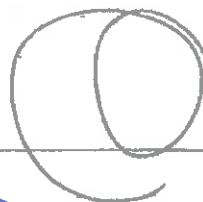

303



3.4 The Parties to this Agreement agree to take all measures that may be required to ensure that all the events contemplated in the Clauses 3.1 to 3.3 above on the Closing Date are completed on the same day.

Notwithstanding the provisions of Clause 3.3 hereto, all proceedings to be taken and all documents to be executed and delivered by the Parties at the Closing Date shall be deemed to have been taken and executed simultaneously and no proceedings shall be deemed to have been taken nor documents executed or delivered until all have been taken, executed and delivered.

3.5 The Selected Bidder hereby acknowledges and agrees that after the date of acquisition of one hundred percent (100%) of the equity shareholding of the Company, by the Selected Bidder as per Clause 3.3, (a) the authority, rights and obligations of the PFCCCL/Company in respect of the Bid Process shall forthwith cease and any actions to be taken thereafter regarding the Bid Process will be undertaken by Central Transmission Utility of India Limited themselves or through their any other authorized representative(s), (b) all rights and obligations of the PFCCCL/Company shall be of the Selected Bidder and (d) any decisions taken by the PFCCCL/Company prior to the date of its acquisition by the Selected Bidder shall continue to be binding on the Selected Bidder. The Parties hereby agree that this provision shall survive the termination of this Agreement.

3.6 This agreement shall be effective from the date of its signing by the Parties and shall remain in force until all the obligations of the respective Parties under Clause 3.3 hereto are fulfilled.

#### 4. REPRESENTATIONS AND WARRANTIES

4.1 The Selected Bidder hereby represents and warrants to the Shares Seller that:

4.1.1 The Selected Bidder has full legal right, power and authority to enter into, execute and deliver this Agreement and to perform the obligations, undertakings and transactions set forth herein, and this Agreement has been duly and validly executed and delivered by the Selected Bidder and constitutes its legal, valid and binding obligations, enforceable against it in accordance with its terms;

4.1.2 The execution, delivery and performance of this Agreement by the Selected Bidder will not violate or contravene any provision of the Memorandum of Association or Articles of the Selected Bidder, (ii) will not violate or contravene any law, statute, rule, regulation, licensing requirement, order, writ, injunction or decree of any court, governmental instrumentality or other regulatory, governmental or public body, agency or authority by which the Selected Bidder are bound or by which any of its and/or their properties or assets are bound, and (iii) except to the extent that the same have been duly and properly completed or obtained, will not require any filing with, or permit, consent or approval of or license from, or the giving of any notice to, any court, governmental instrumentality or other regulatory, governmental or public

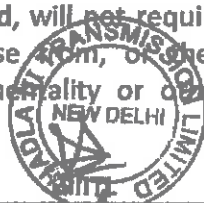
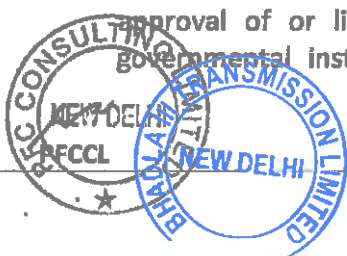

304

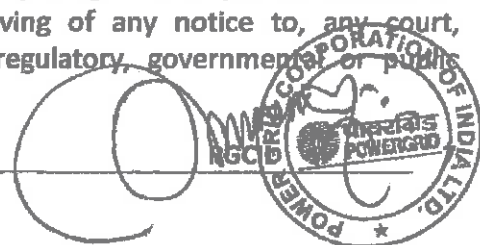



body, agency or authority, joint venture party, or any other entity or person whatsoever; and

4.1.3 The Selected Bidder is not restricted in any manner whatsoever, including without limitation, on account of any judicial or governmental order, action or proceeding, or any contractual obligation assumed by the Selected Bidder, from purchasing the Sale Shares from the Shares Seller in the manner provided for in this Agreement.

4.2 The Shares Seller hereby represents and warrants to the Selected Bidder that;

4.2.1 The Shares Seller and the Nominees are the legal and beneficial owners of the Sale Shares, free and clear of any Encumbrance and the delivery to the Selected Bidder of the Sale Shares pursuant to the provisions of this Agreement will transfer to the Selected Bidder a good title to the Sale Shares.

4.2.2 The Shares Seller has full legal right, power and authority to enter into, execute and deliver this Agreement and to perform the obligations, undertakings and transactions set forth herein. The execution, delivery and performance of this Agreement will not violate the Memorandum and Articles of Association of the Shares Seller or contravene any contract by which it is bound.

4.2.3 The Shares Seller has obtained requisite authorizations to sell and transfer the Sale Shares to the Selected Bidder. The Shares Seller also represent that it is not prevented from transferring and selling the Sale Shares. Also, to the best of its knowledge, the Sale Shares are not the subject matter of any claim or pending proceeding or threatened by any legal proceeding made by any third party.

4.3 Except as specified in Clause 4.2, above the Shares Seller shall not be deemed to have, made any representation or warranty whatsoever, whether express or implied, in relation to the Sale Shares or Company, including but not limited to any implied warranty or representation as to the business or affairs of the Company.

4.4 The Representations and Warranties are given as at the date of this Agreement except that where a Representation and Warranty is expressed to be made as at another date, the Representation and Warranty is given with respect to that date only.

4.5 Each Representation and Warranty is to be construed independently of the others and is not limited by reference to any other Warranty. The Representations, Warranties and undertakings contained in this Clause 4 hereto or in any document delivered pursuant to or in connection with this Agreement are continuing in nature and shall survive the Closing Date for one (1) year.

4.6 The Parties represent to each other that all Representations and Warranties provided herein by the respective Party shall be true as of Closing Date.

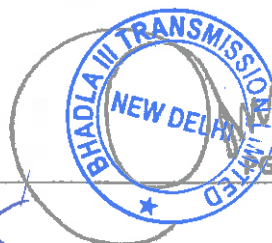

265

## 5. OBLIGATIONS OF THE SELECTED BIDDER

The Selected Bidder agrees that the Shares Seller shall not be liable in any manner, nor shall it assume any responsibility or liability whatsoever, in respect of the business of the Company and its operations or activities, arising after Closing Date, to any Person or any authority, central, state, local or municipal or otherwise and the same shall be the sole responsibility of the Selected Bidder.

## 6. MISCELLANEOUS

### 6.1 NOTICES

- a) All notices to be given under this Agreement shall be in writing and in the English language.
- b) All notices must be delivered personally or by registered or speed post or by recognised courier to the addresses below:

<b>Selected Bidder</b>	<b>Company Secretary, Power Grid Corporation Of India Limited B-9, Qutub Institutional Area, Katwaria Saria, New Delhi - 110016</b>
<b>Name of the Holding Company of the SPV</b>	<b>Company Secretary, PFC Consulting Limited First Floor, "Urjanidhi", 1 Barakhamba Lane, Connaught Place, New Delhi- 110001</b>
<b>Company (Before Closing Date)</b>	<b>Project In-charge Bhadla III Transmission Limited First Floor, "Urjanidhi", 1 Barakhamba Lane, Connaught Place, New Delhi- 110001</b>
<b>Company (After Closing Date)</b>	<b>Bhadla III Transmission Limited B-9, Qutub Institutional Area, Katwaria Saria, New Delhi - 110016</b>

- c) Any Party may by notice of at least fifteen (15) days to the other Parties change the address and / or addresses to which such notices and communications to it are to be delivered or mailed.

### 6.2 RESOLUTION OF DISPUTES



306

6.2.1. If any dispute arises between the Parties, in connection with the validity, interpretation, implementation or alleged breach of any provision of this Agreement ("Dispute"), the disputing Parties hereto shall endeavour to settle such Dispute amicably. The attempt to bring about an amicable settlement shall be considered to have failed if not resolved within 60 days from the date of the Dispute.

6.2.2 If the Parties are unable to amicably settle the Dispute in accordance with Clause 6.2.1 within the period specified therein, any of the Parties shall be entitled to within 30 days after expiry of the aforesaid period, refer the Dispute to the Company Secretary of PFCCCL and Chief Executive/ Managing Director of the Selected Bidder for resolution of the said Dispute. The attempt to bring about such resolution shall be considered to have failed if not resolved within 30 days from the date of receipt of a written notification in this regard.

6.2.3 In the event the Dispute is not settled in accordance with Clause 6.2.2 above, any Party to the Dispute shall be entitled to serve a notice invoking this Clause and making a reference to a sole arbitrator. If the Parties to the Dispute cannot agree as to the appointment of the sole arbitrator within 30 days of receipt of the notice of the Party making the reference, then the Shares Seller along with the Company shall appoint one arbitrator and the Selected Bidder shall appoint one arbitrator and the two arbitrators, so appointed shall appoint a third arbitrator. However, after the Closing Date, in such an event the Shares Seller shall appoint one arbitrator and the Selected Bidder along with the Company shall appoint one arbitrator and the two arbitrators, so appointed shall appoint the third arbitrator.

6.2.4 The place of the arbitration shall be New Delhi. The Arbitration proceedings shall be governed by the Arbitration and Conciliation (Amendment) Act, 2015.

6.2.5 The proceedings of arbitration shall be in English language.

6.2.6 The arbitrator's award shall be substantiated in writing. The arbitrators shall also decide on the costs of the arbitration proceedings. In case the arbitrators have not decided on the costs of the arbitration proceedings, each Party to the Dispute shall bear its own costs, in relation to the arbitration proceedings.

### 6.3 AUTHORISED PERSON

For the purposes of this Agreement, the Selected Bidder is represented by Mr. Mrinal Shrivastava, Company Secretary, pursuant to an authorization granted to Mr. Mrinal Shrivastava, Company Secretary through necessary Board resolutions. Further, Mr. Mrinal



207

Shrivastava, Company Secretary is also authorized by such resolutions to take any decision which may be required to be taken, do all acts and execute all documents which are or may be required by the Selected Bidder for the proper and effective fulfillment of the rights and obligations under this Agreement. Any action taken or document executed by Mr. Mrinal Shrivastava, Company Secretary shall be deemed to be acts done or documents executed by the Selected Bidder and shall be binding on the Selected Bidder.

#### 6.4 RESERVATION OF RIGHTS

No forbearance, indulgence or relaxation or inaction by any Party at any time to require performance of any of the provisions of this Agreement shall in any way affect, diminish or prejudice the right of such Party to require performance of that provision, and any waiver or acquiescence by any Party of any breach of any of the provisions of this Agreement shall not be construed as a waiver or acquiescence of any continuing or succeeding breach of such provisions, a waiver of any right under or arising out of this Agreement or acquiescence to or recognition of rights other than that expressly stipulated in this Agreement.

#### 6.5 CUMULATIVE RIGHTS

All remedies of either Party under this Agreement whether provided herein or conferred by statute, civil law, common law, custom or trade usage, are cumulative and not alternative and may be enforced successively or concurrently.

#### 6.6 PARTIAL INVALIDITY

If any provision of this Agreement or the application thereof to any person or circumstance shall be invalid or unenforceable to any extent, the remainder of this Agreement and the application of such provision to persons or circumstances other than those as to which it is held invalid or unenforceable shall not be affected thereby, and each provision of this Agreement shall be valid and enforceable to the fullest extent permitted by law. Any invalid or unenforceable provision of this Agreement shall be replaced with a provision, which is valid and enforceable and most nearly reflects the original intent of the unenforceable provision.

#### 6.7 TERMINATION

If (i) the Closing does not occur on the Closing Date for any reason whatsoever, or (ii) the Letter of Intent is withdrawn or terminated for any reason, or (iii) due to termination of the TSA by Central Transmission Utility of India Limited in accordance with Article 3.3.2 or Article 13 of the TSA thereof, PFCCL shall have a right to terminate this Agreement forthwith by giving a written notice to the other Parties hereto.



308

**6.8 AMENDMENTS**

No modification or amendment of this Agreement and no waiver of any of the terms or conditions hereof shall be valid or binding unless made in writing and duly executed by all the Parties.

**6.9 ASSIGNMENT**

This Agreement and the rights and liabilities hereunder shall bind and inure to the benefit of the respective successors of the Parties hereto, but no Party hereto shall assign or transfer its rights and liabilities hereunder to any other Person without the prior written consent of the other Parties, which will not be unreasonably withheld.

**6.10 ENTIRE AGREEMENT**

This Agreement constitutes the entire Agreement between the Parties with respect to the subject matter herein and supersedes and cancels any prior oral or written agreement, representation, understanding, arrangement, communication or expression of intent relating to the subject matter of this Agreement.

**6.11 COSTS**

Each of the Parties hereto shall pay their own costs and expenses relating to the negotiation, preparation and execution of this Agreement and the transactions contemplated by this Agreement.

The Selected Bidder shall be liable to bear and pay the stamp duty and other costs in respect of this Agreement and the Share Transfer Forms.

**6.12 RELATIONSHIP**

None of the provisions of this Agreement shall be deemed to constitute a partnership between the Parties hereto and no Party shall have any authority to bind the other Party otherwise than under this Agreement or shall be deemed to be the agent of the other in any way.

**6.13 GOVERNING LAW AND JURISDICTION**

This Agreement shall be governed by and construed in accordance with the laws of India and shall be subject to the exclusive jurisdiction of the courts of Delhi.

**6.14 COUNTERPARTS**

This Agreement may be executed in counterparts by the Parties and each fully executed counterpart shall be deemed to be original.

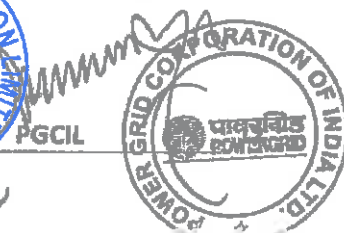

309

### 6.15 CONFIDENTIALITY

The Parties undertake to hold in confidence and not to disclose the terms and conditions of the transaction contemplated hereby to third parties, except:

- (a) to their professional advisors;
- (b) to their officers, employees, agents or representatives, who need to have access to such information for the proper performance of their activities;
- (c) disclosures required under Law;

without the prior written consent of the other Parties.

Provided that Central Transmission Utility of India Limited and PFCL may at any time, disclose the terms and conditions of transactions contemplated hereby to any person, to the extent stipulated under the law or the Bidding Guidelines.

### 6.16 INDEMNIFICATION

- The Parties hereby agree that transfer of Sale Shares to the Selected Bidder shall vest all the rights, privileges, licenses, responsibilities, liabilities and other obligations pertaining to the Company in the Selected Bidder.
- The Selected Bidder hereby agrees that the Selected Bidder shall not be entitled to any claims or initiate any legal proceedings, by itself or through the Transmission Service Provider against the Share Sellers, its directors, officers, employees and the subscribers including the members of any committees appointed by them in respect of any actions or decisions taken by any of them up to the Closing Date in furtherance of the Project referred to in recital A of this Agreement.
- Further, the Selected Bidder hereby indemnifies and holds harmless at all times the Share Seller against all losses, damages, charges, and expenses which the Share Seller may sustain or incur towards contractual obligations with respect to the contracts awarded by the Share Seller or any other liability arising with regard to any action/ activity undertaken by the Share Seller for and on behalf of the Company in furtherance of the Project referred to above or otherwise concerning the Company. All such actions shall be defended by the Selected Bidder either itself or through the TSP at its own cost.
- The Parties hereby agree that the provisions of this clause shall survive the termination of this Agreement.

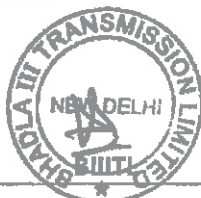

310



IN WITNESS WHEREOF, THE PARTIES HERETO HAVE CAUSED THIS AGREEMENT TO BE DULY EXECUTED AND DELIVERED AS OF THE DAY AND YEAR FIRST ABOVE WRITTEN

  

SIGNED AND DELIVERED  
BY THE WITHIN NAMED "PFCCL" PFC CONSULTING LIMITED

BY THE HAND OF MR. SACHIN ARORA, COMPANY SECRETARY

PURSUANT TO THE RESOLUTION PASSED BY THE BOARD OF DIRECTORS ON 04<sup>TH</sup> SEPTEMBER 2023.

ON THE 27<sup>TH</sup> DAY OF SEPTEMBER 2023

  
(ANUPAM KASHYAP  
Chief Manager)

IN THE PRESENCE OF:  
WITNESS:  
NAME, SIGNATURE, DESIGNATION AND ADDRESS:

  

SIGNED AND DELIVERED  
BY THE WITHIN NAMED "Company" BHADLA III TRANSMISSION LIMITED

BY THE HAND OF MR. SANJAY NAYAK, DIRECTOR & PROJECT IN-CHARGE

PURSUANT TO THE RESOLUTION PASSED BY THE BOARD OF DIRECTORS ON 28<sup>TH</sup> JULY 2023

ON THE 27<sup>TH</sup> DAY OF SEPTEMBER 2023



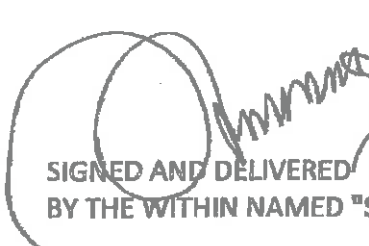
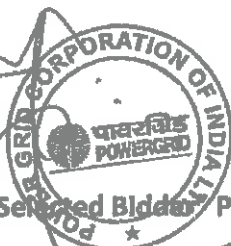

  
(HARISH BHAKUNI)  
CHIEF MANAGER

IN THE PRESENCE OF:  
WITNESS:  
NAME, SIGNATURE, DESIGNATION AND ADDRESS:

SIGNED AND DELIVERED  
BY THE WITHIN NAMED "Selected Bidder" POWER GRID CORPORATION OF INDIA LIMITED

BY THE HAND OF MR. MRINAL SHRIVASTAVA, AUTHORIZED SIGNATORY

PURSUANT TO THE RESOLUTION PASSED BY THE BOARD OF DIRECTORS ON 27<sup>TH</sup> MARCH 2022

ON THE 27<sup>TH</sup> DAY OF SEPTEMBER, 2023.

IN THE PRESENCE OF:

WITNESS

NAME, SIGNATURE, DESIGNATION AND ADDRESS  
MRINAL SHRIVASTAVA  
Company Secretary  
Power Grid Corporation of India Ltd.  
(A Govt. of India Enterprise)  
Plot No. 6, Sector-28, Gurgaon-122 001 (Haryana)

*Rohit Jain*  
ROHIT JAIN  
Manager (TBCB)  
POWERGRID  
(Witness)

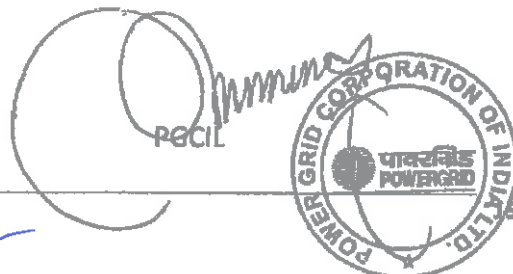

3/2

**ANNEXURE A****DESCRIPTION OF THE SALE SHARES**

S. NO.	NAME OF THE SHAREHOLDER	NUMBER OF EQUITY SHARES HELD	PERCENTAGE OF THE TOTAL PAID UP EQUITY CAPITAL
1.	PFC Consulting Limited	9400	94 %
2.	Shri Manoj Kumar Rana (Nominee of PFC Consulting Limited)	100	1 %
3.	Shri Rishab Jain (Nominee of PFC Consulting Limited)	100	1 %
4.	Shri Milind Madhusudan Dafade (Nominee of PFC Consulting Limited)	100	1 %
5.	Shri Neeraj Singh (Nominee of PFC Consulting Limited)	100	1 %
6.	Shri Sanjay Kumar Nayak (Nominee of PFC Consulting Limited)	100	1 %
7.	Shri Sachin Shukla (Nominee of PFC Consulting Limited)	100	1 %
	<b>Total</b>	<b>10000</b>	<b>100%</b>



313



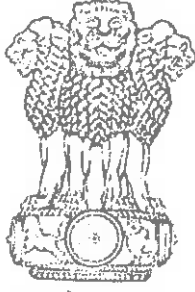

सत्यमेव जयते

INDIA NON JUDICIAL

Government of National Capital Territory of Delhi

e-Stamp

Certificate No. : IN-DL72328959180286V  
Certificate Issued Date : 26-Sep-2023 02:09 PM  
Account Reference : IMPACC (IV)/ dl1074803/ DELHI/ DL-DLH  
Unique Doc. Reference : SUBIN-DL DL107480310767536155197V  
Purchased by : BHADLA III TRANSMISSION LIMITED  
Description of Document : Article 48(c) Power of attorney - GPA  
Property Description : Not Applicable  
Consideration Price (Rs.) : 0  
(Zero)  
First Party : BHADLA III TRANSMISSION LIMITED  
Second Party : Not Applicable  
Stamp Duty Paid By : BHADLA III TRANSMISSION LIMITED  
Stamp Duty Amount(Rs.) : 100  
(One Hundred only)

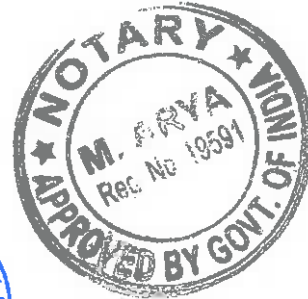
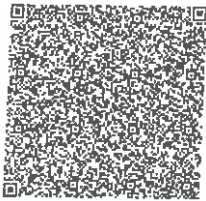

General Power of Attorney

Know all men by these presents, we **Bhadla III Transmission Limited** (hereinafter referred to as **BIITL** which expression shall unless repugnant to the context or meaning thereof, include its successors, administrators, and assigns) having its Registered Office at B-9, Qutab Institutional Area, Katwaria Sarai, New Delhi – 110 016 do hereby constitute, appoint and authorize **Shri Upendra Singh**, Project Incharge of BIITL residing at House No. 5-D-66, Jai Narayan Vyas (JNV) Colony, Bikaner (Rajasthan) as our true and lawful attorney, to do in our name and our behalf, all of the acts or things hereinafter mentioned, that is to say,

*[Handwritten signature]*  
315

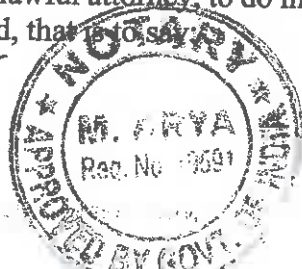

1. To constitute, and defend legal cases, sign and verify complaints, written statements, petitions and objections, memorandum of appeal, claims, affidavits, applications, re-applications and pleadings of all kinds and to file them in Central Electricity Regulatory Commission (CERC), State Electricity Regulatory Commissions (SERCs), Appellate Tribunal for Electricity (ATE), Civil, Criminal or Revenue courts, Arbitration, Labour Court, Industrial Tribunal, High Court and Supreme Court, whether having original or appellate jurisdiction and before Government or Local Authorities or Registration Authorities, Tax Authorities, Tribunals, etc.
2. To appear, before various Courts / Tribunals / CERC / SERCs / Appellate Tribunal for Electricity.
3. To appoint any Advocate, Vakil, Pleader, Solicitor or any other legal practitioner as Attorney to appear and conduct case proceedings on behalf of the company and to sign Vakalatnama.
4. To compromise, compound or withdraw cases from any Court / Tribunal / CERC / SERCs / Appellate Tribunal for Electricity.
5. To file petitions/applications or affidavits before the Supreme Court / High Court / CERC / SERCs / Appellate Tribunal for Electricity and to obtain the copies of documents, papers, records etc.
6. To file and receive back documents, to deposit and withdraw money from Courts, Tribunal, Registrar's Office and other Government or Local Authorities and to issue valid receipts thereof.
7. To apply for and obtain refund of stamp duty or court fee, etc.
8. To issue notices and accept service of any summons, notices or orders issued by any Court / Tribunal / CERC / SERCs / Appellate Tribunal for Electricity on behalf of the Company.
9. To execute deeds, agreements, bonds and other documents and returns in connection with the affairs of the company and file them or cause to be filed for Registration, whenever necessary.
10. To issue Project Authority Certificate(s) in respect of contracts for Load Despatch & Communication Systems, Transmission Systems etc. and to lodge claims with the Railways, Transporters, Shipping Agents and Clearing Agents and to settle/compromise such claims.
11. To lodge claims with the Insurance companies, to settle/compromise such claims and on satisfactory settlement thereof, to issue letters of subrogation/power of attorney in favour of Insurance companies.
12. To execute, sign and file applications, undertakings, agreements etc. to or with the Central / State Government(s) / Body(ies) to obtain 'right of way' or any of other Right(s) / Privilege(s) etc.
13. To execute, sign and file applications, undertakings, agreements, bills, documents etc. to or with the Central / State Government(s) / Body(ies) and other authorities / entities including Central Transmission Utility (CTU)/Power System Operation Corporation Limited (POSOCO) / Central Electricity Authority (CEA)/ CERC with respect to Commissioning



*Handwritten signature and initials*





of the Project, realization of Transmission charges, to obtain 'right of way' or any of other Right(s) / Privilege(s) etc.

14. To execute Transmission Service Agreement (TSA) with Central Transmission Utility of India Limited (CTUIL)
15. To execute Consultancy, Funding and other Agreements.
16. To act as administrator for e-filing process with CERC and other Statutory authorities.
17. Generally to do all lawful acts, necessary for the above mentioned purposes.

The Company hereby agrees to ratify and confirm all and whatsoever the said Attorney shall lawfully do execute or perform or cause to be done, executed or performed in exercise of the power or authority conferred under and by virtue of this Power of Attorney.

.....  
Signed by the within named  
**Bhadla III Transmission Limited**  
through the hand of  
Duly authorized by the Board to issue such Power of Attorney

Dated this 27<sup>th</sup> day of Sept, 2023

Accepted

.....  
Signature of Attorney

Name: Shri Upendra Singh  
Designation: Project Incharge, **Bhadla III Transmission Limited**  
Address: House No. 5-D-66, Jai Narayan Vyas (JNV) Colony, Bikaner (Rajasthan)

.....  
Attested

.....  
(Signature of the Executant)  
Name: Sh. Ramesh Kumar  
Designation: Director  
Address: B-9, Qutab Institutional Area, Kawaria Sarai, New Delhi - 110 016

**ATTESTED**  
**NOTARY PUBLIC**

27 SEP 2023

.....  
Signature and Stamp of Notary of the place of execution

WITNESS



SW 317