

BEFORE THE CENTRAL ELECTRICITY REGULATORY COMMISSION

NEW DELHI

APPLICATION No :.....

IN THE MATTER OF

Application under Section 63 of the Electricity Act, 2003 for Adoption of Transmission Charges with respect to the Transmission System being established by the Bikaner A Power Transmission Limited (a 100% wholly owned subsidiary of Power Grid Corporation of India Limited)

Bikaner A Power Transmission Limited

(A 100% wholly owned subsidiary of Power Grid Corporation of India Limited)

Registered office: B-9, Qutab Institutional Area, Katwaria Sarai, New Delhi 110 016

Address for correspondence: C/o ED (TBCB), Power Grid Corporation of India Limited, Saudamini, Plot no.2, Sector -29, Gurgaon 122001

AND

Chief Operating Officer,
Central Transmission Utility of India Ltd,
Saudamini, Plot no.2, Sector -29,
Gurgaon 122001.....

RESPONDENT(S)

And Others

INDEX

Sl. No.	Description	Enclosures	Page No.
1	CERC Letter	-	(iii)
2	Form 1	-	(iv)-(v)
3	Memo of Appearance		(vi)
4	Dispatch proof	-	(vii)
5	Letter for registration	-	04
6	Memo of parties	-	05-08
7	Affidavit	-	09-10
8	Application	-	11-16
9	Extract of Gazette notification no. 1298 [F. No. 15/3/2018-Trans-Part (4)] dated 15.03.2024 has notified REC Power Development and Consultancy Limited to be the Bid Process Coordinator (BPC)	Annexure-1	17-18
10	Certificate of Incorporation of Bikaner A Power Transmission Limited	Annexure-2	19
11	Memorandum of Association and Articles of Association of Bikaner A Power Transmission Limited	Annexure-3	20-50

(i)

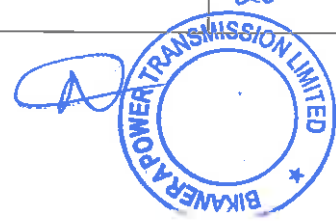

12	Global Invitation for Qualification as published in the newspapers	Annexure-4	51
13	Extract of the RFP document as provided by BPC	Annexure-5	52-53
14	Certificate by Bid Evaluation Committee	Annexure-6	54
15	Copy of Letter of Intent (LoI)	Annexure-7	55-61
16	Copy of relevant extract of Request for Proposal (RFP) along with letters from BPC	Annexure-8	62-65
17	Copy of Transmission Service Agreement (TSA)	Annexure-9	66-301
18	Copy of the BPC letters dated 02.08.2024 and 07.11.2024	Annexure-10	302-304
19	Copy of Share purchase agreement (SPA)	Annexure-11	305-324
20	SLD of the transmission scheme	Annexure-12	325

Aarsh
FILED BY

Bikaner A Power Transmission Limited

Place: New Delhi

Date: 14.11.2024



Bikaner A Power Transmission Limited

(A 100% wholly owned subsidiary Power Grid Corporation of India Limited)

B-9, Qutab Institutional Area, Katwaria Sarai, New Delhi - 110 016

CIN : U42202DL2024GOI431226

Ref: PG_BAPTL/

Dated: 14.11.2024

To,
The Secretary,
Central Electricity Regulatory Commission,
7th Floor, Tower B, World Trade Centre,
Nauroji Nagar, New Delhi-110029.

Sub.: Application under Section 63 of the Electricity Act, 2003 for Adoption of Transmission Charges with respect to the Transmission System being established by the Bikaner A Power Transmission Limited (a 100% wholly owned subsidiary of Power Grid Corporation of India Limited)

Sir,

Three copies (1 original + 2 copies) of the application for the above subject matter have been enclosed and e-filing has been done on CERC website. As per the public notice issued on 28.08.2010 by the Hon'ble Commission, the amount of Rs. 25,00,000/- (Rupees Twenty Five Lakhs only) for filing the application is being paid through RTGS and in accordance with the Regulations 12 (2), Payment of Fees Regulations 2012, Form-1 duly filled in against the aforementioned application is also enclosed herewith.

Electronic Copies of the application are being forwarded to the CTUIL (Nodal Agency) and to the Bid Process Coordinator and beneficiaries of the Northern Region and DICs as party to the Petition based on the list of the beneficiaries furnished by the CTUIL. The complete application along with Annexures is posted on the website: www.powergrid.in/subsidiaries.

Thanking You,

Yours faithfully,



(Naresh Kumar)

Finance Incharge

Bikaner A Power Transmission Limited

Mobile: +91-9718377851 ; email : tbcb@powergrid.in

Enclosures: As above



(11)

Form-I

Particulars

1. Name of the Petitioner : **Bikaner A Power Transmission Limited**
(A 100% wholly owned subsidiary of
Power Grid Corporation of India Limited)
2. Address of the Petitioner/Applicant : **Bikaner A Power Transmission Limited**
(A 100% wholly owned subsidiary of Power Grid Corporation of India Limited)
Regd. Address:
B-9, Qutab Institutional Area,
Katwaria Sarai, New Delhi-110 016
Address for correspondence:
Finance Incharge, Bikaner A Power Transmission Limited , C/o ED(TBCB), Power Grid Corporation of India Ltd, Saudamini, Plot no.2, Sector - 29, Gurgaon 122001
3. Subject Matter : Application under Section 63 of the Electricity Act, 2003 for Adoption of Transmission Charges with respect to the Transmission System being established by the Bikaner A Power Transmission Limited (a 100% wholly owned subsidiary of Power Grid Corporation of India Limited)
4. Petition No., if any : Not yet received
5. Details of generation assets : NOT APPLICABLE
(a) generating station/units
(b) Capacity in MW
(c) Date of commercial operation
(d) Period for which fee paid
(e) Amount of fee paid
(f) Surcharge, if any
6. Details of transmission assets : Assets under implementation by
(a) Transmission line and sub-stations **Bikaner A Power Transmission Limited**
(b) Date of commercial operation
(c) Period for which fee paid
(d) Amount of fee paid
(g) Surcharge, if any
7. Fee paid for Adoption of tariff for :
(a) Generation asset NO
(b) Transmission asset YES
8. Application fee for licence : NOT APPLICABLE

(iv)

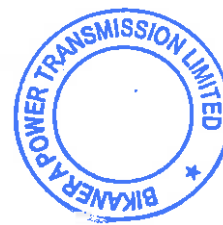

- (a) Trading licence
- (b) Transmission licence
- (c) Period for which paid
- (d) Amount of fee paid

9. Fees paid for Miscellaneous Application : NOT APPLICABLE

10. Fees paid for Interlocutory Application : NOT APPLICABLE

11. Fee paid for Regulatory Compliance petition : NOT APPLICABLE

12. Fee paid for Review Application : NOT APPLICABLE

13. Licence fee for inter-State Trading : NOT APPLICABLE

- (a) Category
- (b) Period
- (c) Amount of fee paid
- (d) Surcharge, if any

14. Licence fee for inter-State Transmission : NOT APPLICABLE

- (a) Expected/Actual transmission charge
- (b) Period
- (c) Amount of fee calculated as a percentage of transmission charge.
- (d) Surcharge, if any

15. Annual Registration Charge for Power Exchange : NOT APPLICABLE

- (a) Period
- (b) Amount of turnover
- (c) Fee paid
- (d) Surcharge, if any

16. Details of fee remitted

- (a) UTR No. : ICICR22024111406236592
- (b) Date of remittance : 14.11.2024
- (c) Amount remitted : Rs.25,00,000 (Rupees Twenty Five Lakh only)

Signature of the authorized
signatory with date



**BEFORE
THE CENTRAL ELECTRICITY REGULATORY COMMISSION**

NEW DELHI

Petition No.: -----

IN THE MATTER OF: Application under Section 63 of the Electricity Act, 2003 for Adoption of Transmission Charges with respect to the Transmission System being established by the Bikaner A Power Transmission Limited (a 100% wholly owned subsidiary of Power Grid Corporation of India Limited)

MEMO OF APPEARANCE

Bikaner A Power Transmission Limited --- PETITIONER

1. Pankaj Pandey, ED, POWERGRID
2. Shri Naresh Kumar, Finance Incharge, Bikaner A Power Transmission Limited
3. Ashwini Kumar Das, GM, POWERGRID

Filed by
Bikaner A Power Transmission Limited
Represented by

Place: New Delhi

Date: 14.11.2024

Naresh Kumar
Finance Incharge
(Bikaner A Power Transmission Limited)

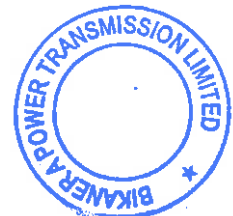

Rohit Jain {रोहित जैन}

From: Lingolu Aditya Mahesh {लिंगोलु आदित्य महेश}
Sent: 19 November 2024 21:12
To: angshuman.rudra@avaada.com; vivek.jain@avaada.com; shudhsolar@gmail.com; karunain2000@yahoo.com; mehta.saurabh2@mahindra.com; pathak.ankur@mahindra.com; amanna@ntpc.co.in; rajivgupta@ntpc.co.in; approvals.amgepl@arcelormittal.com; vishal.soni@arcelormittal.com; ashu.gupta@cleanmax.com; vidisha.dubey@cleanmax.com; iraaxinfo@gmail.com; law.uni.aniketvyas@gmail.com; rajeev.thanvi@blupineenergy.com; ashish.agarwal@blupineenergy.com; sharad.gangwar@blupineenergy.com; ayush.jain@blupineenergy.com; tarunveer.singh@sunsure.in; regulatory@sunsure.in; tarun.rajpud@sunsure.in; business.expansion@sjvn.nic.in; cso.sgel@sjvn.nic.in; kuldeepssindhu@gmail.com; shubham.roy@dattainfra.com; ravi.damaraju@feplglobal.com; Vasundhara.sen@feplglobal.com; apc.chandigarh@gmail.com; elop2-chd@nic.in; sanjay.srivastava@relianceada.com; gurmeet.deogen@relianceada.com; sunil.kakkar@relianceada.com; vikas.a.gupta@relianceada.com; eesldc.elect@ndmcmail.gov.in; ndmcsldc@gmail.com; sandeep.k@tatapower-ddl.com; r.k@tatapower-ddl.com; seinterstate@gmail.com; aosld302@gmail.com; billhppc@uhbvn.org.in; saohppc@uhbvn.org.in; cejkpcl2@gmail.com; aeeldmt1@gmail.com; xenisb1@gmail.com; ce-ppr-praapti@pspl.in; sonu@powergridindia.com; skrai@powergrid.in; dycerppc@yahoo.co.in; serppc@yahoo.co.in; srdeetrdald123@gmail.com; abind1453@gmail.com; cgmupcl@yahoo.com; cecommercialupcl@gmail.com; seiepclko@upptcl.org; fmuppl@gmail.com; anilgarg@lnjbhilwara.com; romin.bose@lnjbhilwara.com; haresh.satapathy@gmrgroup.in; abhishekgupta@hpppl.in; ctatrddelhidivision@gmail.com; SSrivastava@noidapower.com; ppundir@noidapower.com; srdeetrdnr@gmail.com; openaccessup@gmail.com
Cc: Pankaj Pandey {पंकज पाण्डेय}; Ashwini Kr Das {अश्विनी कुमार दास}; Rohit Jain {रोहित जैन}; Kaushal Kishor {कौशल किशोर}; Vikas Kumar {विकास कुमार}
Subject: Bikaner B Power Transmission Limited: Application under Section 63 of the Electricity Act, 2003 for Adoption of Transmission Charges
Attachments: AoTC_sec63_BBTL_email.PDF

Dear Sir/Mam,

The following application is being filed before CERC:

Application under Section 63 of the Electricity Act, 2003 for Adoption of Transmission Charges with respect to the Transmission System being established by the Bikaner B Power Transmission Limited (a 100% wholly owned subsidiary of Power Grid Corporation of India Limited)

The soft copy of this application is attached with this mail for your kind information and necessary action please.

With Regards,

Bikaner B Power Transmission Limited

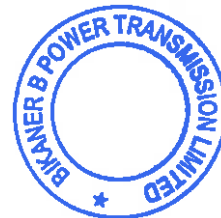

(३३)

BEFORE
THE CENTRAL ELECTRICITY REGULATORY
COMMISSION
NEW DELHI

Application under Section 63 of the Electricity Act, 2003 for adoption of Transmission charges with respect to the Transmission System being established by the Bikaner A Power Transmission Limited (a 100% wholly owned subsidiary of Power Grid Corporation of India Limited)

APPLICATION NO :

Bikaner A Power Transmission Limited
(A 100% wholly owned subsidiary of Power Grid Corporation of India Limited)

Registered office:

B-9, Qutab Institutional Area, Katwaria Sarai, New Delhi 110 016

Address for correspondence:

C/o ED (TBCB), Power Grid Corporation of India Limited
Saudamini, Plot no.2, Sector -29, Gurgaon 122001
GURGAON-122 001 (HARYANA)





**BEFORE THE CENTRAL ELECTRICITY REGULATORY COMMISSION
NEW DELHI**

APPLICATION No :.....

IN THE MATTER OF

Application under Section 63 of the Electricity Act, 2003 for Adoption of Transmission Charges with respect to the Transmission System being established by the Bikaner A Power Transmission Limited (a 100% wholly owned subsidiary of Power Grid Corporation of India Limited)

Bikaner A Power Transmission Limited

(A 100% wholly owned subsidiary of Power Grid Corporation of India Limited)

Registered office: B-9, Qutab Institutional Area, Katwaria Sarai, New Delhi 110 016

Address for correspondence: C/o ED (TBCB), Power Grid Corporation of India Limited, Saudamini, Plot no.2, Sector -29, Gurgaon 122001

AND

Chief Operating Officer,
Central Transmission Utility of India Ltd,
Saudamini, Plot no.2, Sector -29,
Gurgaon 122001.....

RESPONDENT(S)

And Others

INDEX

Sl. No	Description	Annexure No.	Page No.
1.	Letter for registration	-	04
2.	Memo of parties	-	05-08
3.	Affidavit	-	09-10
4.	Application	-	11-16
5.	Extract of Gazette notification no. 1298 [F. No. 15/3/2018-Trans-Part (4)] dated 15.03.2024 has notified REC Power Development and Consultancy Limited to be the Bid Process Coordinator (BPC)	Annexure-1	17-18
6.	Certificate of Incorporation of Bikaner A Power Transmission Limited	Annexure-2	19
7.	Memorandum of Association and Articles of Association of Bikaner A Power Transmission Limited	Annexure-3	20-50
8.	Global Invitation for Qualification as published in the newspapers	Annexure-4	51
9.	Extract of the RFP document as provided by BPC	Annexure-5	53

2



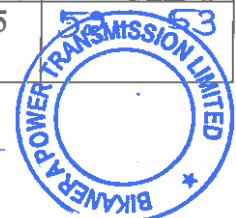

10.	Certificate by Bid Evaluation Committee	Annexure-6	54
11.	Copy of Letter of Intent (LoI)	Annexure-7	55-61
12.	Copy of relevant extract of Request for Proposal (RFP) along with letters from BPC	Annexure-8	62-65
13.	Copy of Transmission Service Agreement (TSA)	Annexure-9	66-301
14.	Copy of the BPC letters dated 02.08.2024 and 07.11.2024	Annexure-10	302-304
15.	Copy of Share purchase agreement (SPA)	Annexure-11	305-324
16.	SLD of the transmission scheme	Annexure-12	325

Filed by
Bikaner A Power Transmission Limited
(A 100% wholly owned subsidiary of Power Grid Corporation of India Limited)



Represented by Naresh Kumar
Finance Incharge, Bikaner A Power Transmission Limited

Place: New Delhi

Date: 11.11.2024



BEFORE THE CENTRAL ELECTRICITY REGULATORY COMMISSION
NEW DELHI

APPLICATION No :

IN THE MATTER OF

Application under Section 63 of the Electricity Act, 2003 for Adoption of Transmission Charges with respect to the Transmission System being established by the Bikaner A Power Transmission Limited (a 100% wholly owned subsidiary of Power Grid Corporation of India Limited)

Bikaner A Power Transmission Limited

(A 100% wholly owned subsidiary of Power Grid Corporation of India Limited)

Registered office: B-9, Qutab Institutional Area, Katwaria Sarai, New Delhi 110 016

Address for correspondence: C/o ED (TBCB), Power Grid Corporation of India Limited, Saudamini, Plot no.2, Sector -29, Gurgaon 122001

AND

Chief Operating Officer,
Central Transmission Utility of India Ltd,
Saudamini, Plot no.2, Sector -29,
Gurgaon 122001.....

RESPONDENT(S)

And Others

To
The Secretary
Central Electricity Regulatory Commission
New Delhi

Sir,

The application filed under Section 63 of the Electricity Act, 2003 for Adoption of Transmission Charges with respect to the Transmission System being established by the Bikaner A Power Transmission Limited (A 100% wholly owned subsidiary of Power Grid Corporation of India Limited) for which transmission charges are determined through transparent process of bidding in accordance with the guidelines issued by the Central Government, may please be registered.

Applicant

Bikaner A Power Transmission Limited

(A 100% wholly owned subsidiary of Power Grid Corporation of India Limited)



Represented by Naresh Kumar

Finance Incharge, Bikaner A Power Transmission Limited

Place: New Delhi

Date: 11.11.2024

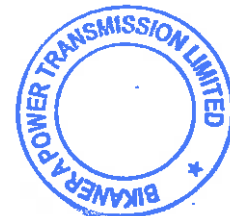

**BEFORE THE CENTRAL ELECTRICITY REGULATORY COMMISSION
NEW DELHI**

APPLICATION No :.....

IN THE MATTER OF

Application under Section 63 of the Electricity Act, 2003 for Adoption of Transmission Charges with respect to the Transmission System being established by the Bikaner A Power Transmission Limited (a 100% wholly owned subsidiary of Power Grid Corporation of India Limited)

Bikaner A Power Transmission Limited

(A 100% wholly owned subsidiary of Power Grid Corporation of India Limited)

Registered office: B-9, Qutab Institutional Area, Katwaria Sarai, New Delhi 110 016

Address for correspondence: C/o ED (TBCB), Power Grid Corporation of India Limited, Saudamini, Plot no.2, Sector -29, Gurgaon 122001

AND

Chief Operating Officer,
Central Transmission Utility of India Ltd,
Saudamini, Plot no.2, Sector -29,
Gurgaon 122001

And Others

To
The Secretary
Central Electricity Regulatory Commission
New Delhi

MEMO OF PARTIES

Bikaner A Power Transmission Limited

(A 100% wholly owned subsidiary of Power Grid Corporation of India Limited)

Registered office: B-9, Qutab Institutional Area, Katwaria Sarai, New Delhi 110 016

Address for correspondence: C/o ED (TBCB), Power Grid Corporation of India Limited, Saudamini, Plot no.2, Sector -29, Gurgaon 122001

VERSUS

1.	Chief Operating Officer, Central Transmission Utility of India Ltd, Saudamini, Plot no.2, Sector -29, Gurgaon 122001Respondent
2.	Chief Executive Officer, REC Power Development and Consultancy LimitedRespondent

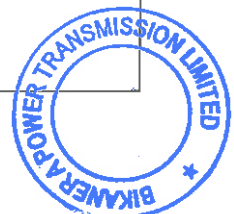

	REC Corporate Head Quarter, D Block, Plot No. I – 4, Sec – 29 Gurugram – 122 001	
3.	Deputy General Manager Avaada RJBikaner Private Limited Avaada Energy Private Limited C-11, Sector- 65, Gautam Buddha Nagar, Noida, Uttar PradeshRespondent
4.	Director Shudh Solar Power Private Limited Shop No. 303, City Pearl, Opp. Ganguar Hotel, M.I. Road, Jaipur, Rajasthan- 302001Respondent
5.	Authorised Signatory Hazel Hybren Private Limited Furies Solren Private Limited B-Block, 6th Floor, Embassy 247, Vikhroli West, Mumbai, Maharashtra- 400083Respondent
6.	DGM NTPC Renewable Energy Limited Netra Building, E-3, Ecotech-II, Udyog Vihar, Greater Noida, Uttar Pradesh – 201306Respondent
7.	Business Head AM Green Energy Private Limited MyHome Twitza, 5th Floor, Plot No. 30/A, Survey No. 83/1 APIIC Knowledge, city of Rai Durg, Rangareddy district, Hyderabad, Telangana -500081Respondent
8.	Authorized Signatory Clean Max Gamma Private Limited First Floor, Clean Max Enviro Energy Solutions Private Limited, The Peach Tree Complex, Sushant Lok Phase I, Gurugram, Haryana122009Respondent
9.	Director Iraax International (Opc) Private Limited R-3, Tilak Marg, civil Lines, Jaipur, Rajasthan-302005Respondent
10	Manager Solarcraft Power India 17 Private Limited 109, First Floor, Rishabh IPEX Mall, IP Extension Patparganj, Delhi -110092Respondent
11	Director Sunsure Solarpark Fourteen Private Limited 1101A-1107, 11th Floor, BPTP Park Centra, Jal Vayu Vihar, Sector 30, Gurugram, Haryana122001Respondent
12	Chief Executive Officer SJVN Green Energy Limited Corporate Headquarters, Shakti Sadan, Shanan, Shimla, Himachal Pradesh-171006Respondent
13	DirectorRespondent

	Deshraj Solar Energy Private Limited Plot no 51 & 51, M-Powered Building, PhaseIV, Udyog Vihar, Gurgaon	
14	CEO First Energy Private Limited Unit No. 601, 6th Floor, Cello Platina, Fergusson College Road, Shivajinagar, Pune Maharashtra- 411 005Respondent
15	Chandigarh Electricity Department UT-Chandigarh, Div-11, Opposite , Transport Nagar, Industrial Area Phase - I , CHANDIGARHRespondent
16	BSES Rajdhani Power Limited AVP (PMG) , PMG Office, 2ND Floor B- Block, Nehru Place, New Delhi-110 019Respondent
17	BSES Yamuna Power Limited Asstt. Vice President (PMG) , Shakti Kiran Bldg, Second Floor, Karkardooma New Delhi-110 032Respondent
18	New Delhi Municipal Council AAO (Commercial), 19th Floor, NDMC,Palika Kendra, Sansad Marg, New Delhi-110 001Respondent
19	Tata Power Delhi Distribution Ltd. Power Management Group, Technology Centre, Near PP-3 Grid Sub Station, Opp. PP Jewellers, Netaji Shubhash Place, Pitampura, New Delhi-110034Respondent
20	Himachal Pradesh State Electricity Board PR&ALDC, HPSEB Ltd , 132 KV S/S Tutu , SHIMLA , 171011 Himachal PradeshRespondent
21	Haryana Power Purchase Centre Shakti Bhawan, Energy Exchange,PANCHKULARespondent
22	Power Development Department, Jammu Jammu SLDC Buliding, Ist Floor, Gladni , Power House Narwal , JAMMU , J&KRespondent
23	Punjab State Power Corporation Limited Shed No. T-1A , Thermal Designs , Patiala , 147001 PunjabRespondent
24	HVDC Dadri, POWERGRIDPOWERGRID B-9, Qutub Institutional Area, , Katwaria Sarai , New Delhi , 110016Respondent
25	HVDC Rihand, POWERGRIDPOWERGRID B-9, Qutub Institutional Area, , Katwaria Sarai , New Delhi , 110016Respondent
26	Ajmer Vidyut Vitran Nigam Limited The Superintending Engineer (Billing) , Rajasthan Urja Vikas Nigam Limited, 132 KV, Sub- Station Building, Calgiri Road Malviya Nagar, Jaipur-302017 (Rajasthan)Respondent

27	Jodhpur Vidyut Vitran Nigam Limited The Superintending Engineer (Billing) , Rajasthan Urja Vikas Nigam Limited, 132 KV, Sub- Station Building, Calgiri Road Malviya Nagar, Jaipur-302017 (Rajasthan)Respondent
28	Jaipur Vidyut Vitran Nigam Limited The Superintending Engineer (Billing) , Rajasthan Urja Vikas Nigam Limited, 132 KV, Sub- Station Building, Calgiri Road Malviya Nagar, Jaipur-302017 (Rajasthan)Respondent
29	North Central Railway DRM Office Nawab Yusuf Road 211011Respondent
30	Uttarakhand Power Corporation Limited Urja Bhawan, Kanwali Road, Dehradun- 248001Respondent
31	Uttar Pradesh Power Corporation Limited Fund Management, Shakti Bhawan, 14 Ashok Marg, Lucknow, UPRespondent
32	AD Hydro AD Hydro Power Limited, Bhilwara Towers, A-12, Sector-1, Noida-201301Respondent
33	GMR Kamalanga Energy Limited 25/1 SKIP HOUSE, 25/1 SKIP HOUSE, MUSEUM ROAD, MUSEUM ROAD, BANGALORE - 560025, Karnataka, +(91)80-40432471Respondent
34	MB Power (Madhya Pradesh) Ltd. 239, Okhla Industrial Estate, Phase -III, New Delhi-110020Respondent
35	HVDC Agra, POWERGRID B-9, Qutub Institutional Area, New DelhiRespondent
36	HVDC Balia, POWERGRID POWERGRID B-9, Qutub Institutional Area, , Katwaria Sarai , New Delhi , 110016Respondent
37	HVDC Bhiwadi, POWERGRID POWERGRID B-9, Qutub Institutional Area, , Katwaria Sarai , New Delhi , 110016Respondent
38	HVDC Kurukshetra, POWERGRID POWERGRID B-9, Qutub Institutional Area, , Katwaria Sarai , New Delhi , 110016Respondent
39	Northern Indian Railway Sr. DEE, TRD, Delhi Division CENTRAL DELHIRespondent
40	Noida Power Company Limited Electric Sub Station Knowledge Park IV, Greater Noida 201310Respondent
41	Northern Railways Sr. DEE/ TRD, DRM Office, Hazratgan Lucknow - 226001Respondent

**BEFORE THE HON'BLE CENTRAL ELECTRICITY REGULATORY COMMISSION
NEW DELHI**

APPLICATION NO:.....

IN THE MATTER OF

Application under Section 63 of the Electricity Act, 2003 for Adoption of Transmission Charges with respect to the Transmission System being established by the Bikaner A Power Transmission Limited (a 100% wholly owned subsidiary of Power Grid Corporation of India Limited)

Bikaner A Power Transmission Limited

(A 100% wholly owned subsidiary of Power Grid Corporation of India Limited)

Registered office: B-9, Qutab Institutional Area, Katwaria Sarai, New Delhi 110 016

Address for correspondence: C/o ED (TBCB), Power Grid Corporation of India Limited, Saudamini, Plot no.2, Sector -29, Gurgaon 122001

AND

Chief Operating Officer,
Central Transmission Utility of India Ltd,
Saudamini, Plot no.2, Sector -29,
Gurgaon 122001.....

RESPONDENT(S)

And Others

AFFIDAVIT



I, Sh. Naresh Kumar, son of Shri Subh Ram residing at Flat No. 304, Luxmi Apartment, Sec10-A, Gurugram - 122001 do hereby solemnly affirm and state as follows:

1. I am the Authorised Signatory of the Applicant Company in the above matter and I am duly authorized by the Applicant Company to affirm this affidavit. I say that I am conversant with the facts and circumstances of this case.
2. The statements made in paragraphs of the application, are true to my knowledge and belief based on the information received and I believe them to be true.

NK  

3. I say that there are no proceedings pending in any court of law/ tribunal or arbitrator or any other authority, wherein the Applicant is a party and where issues arising and/ or reliefs sought are identical or similar to the issues in the matter pending before the Hon'ble Commission.

NK Naresh Kumar

Naresh Kumar
Authorised Signatory

Bikaner A Power Transmission Limited

(A 100% wholly owned subsidiary of Power Grid Corporation of India Limited)

Place: New Delhi

Date: 11.11.2024

VERIFICATION:

I, the Deponent above named hereby solemnly hereby affirms that the contents of my above affidavit are true to my knowledge, no part of it is false and nothing material has been concealed there from. Verified by me on this the 11th day of November 2024 at New Delhi.

NK Naresh Kumar
Deponent

Witness



ATTESTED

[Signature]
NOTARY PUBLIC
NEW DELHI. (INDIA)

11 NOV 2024

**BEFORE THE CENTRAL ELECTRICITY REGULATORY COMMISSION
NEW DELHI**

APPLICATION NO:.....

IN THE MATTER OF

Application under Section 63 of the Electricity Act, 2003 for Adoption of Transmission Charges with respect to the Transmission System being established by the Bikaner A Power Transmission Limited (a 100% wholly owned subsidiary of Power Grid Corporation of India Limited)

Bikaner A Power Transmission Limited

(A 100% wholly owned subsidiary of Power Grid Corporation of India Limited)

Registered office: B-9, Qutab Institutional Area, Katwaria Sarai, New Delhi 110 016

Address for correspondence: C/o ED (TBCB), Power Grid Corporation of India Limited, Saudamini, Plot no.2, Sector -29, Gurgaon 122001

AND

Chief Operating Officer,
Central Transmission Utility of India Ltd,
Saudamini, Plot no.2, Sector -29,
Gurgaon 122001

RESPONDENT(S)

And Others

Application

The Applicant respectfully submits as under:

1. The Government of India, Ministry of Power, vide Gazette notification no. 1298 [F. No. 15/3/2018-Trans-Part (4)] dated 15.03.2024 has notified REC Power Development and Consultancy Limited (RECPDCL) as the Bid Process Coordinator (hereinafter referred to as BPC) for the purpose of selection of Bidder as Transmission Service Provider (TSP) to establish Inter-State Transmission System for "Transmission Service Provider (TSP) to establish Transmission system for evacuation of power from Rajasthan REZ Ph-IV (Part-3: 6GW) [Bikaner complex]: Part A" on build, own, operate and transfer basis. A copy of the notification is enclosed and marked as **Annexure-1, (Page¹⁷ to Page¹⁸.....)**.

The project consists of the following elements:



Sl. No	Name of the Transmission Element	Scheduled COD	Percentage of Quoted Transmission Charges recoverable on Scheduled COD of the Element of the Project	Element(s) which are pre-required for declaring the commercial operation (COD) of the respective Element
1.	<p>Establishment of 6x1500 MVA, 765/400 kV and 6x500 MVA, 400/220 kV Bikaner-IV Pooling Station along with 2x240 MVA (765 kV) and 2x125 MVA (420kV) Bus Reactors at a suitable location near Bikaner</p> <ul style="list-style-type: none"> • 765/400 kV 1500 MVA ICTs- 6 Nos. (19x500 MVA including one spare unit) • 400/220 kV 500 MVA ICTs -6 Nos. • 765 kV line bays – 2 Nos. (for 765 kV interconnection with Siwani S/s) • 400 kV line bays - 4 Nos. (For LILO of both ckts of Bikaner II PS- Bikaner III PS) • 765 kV ICT bays-6 Nos. • 400 kV ICT bays- 12 Nos. • 220 kV ICT bays- 6 Nos. • 240 MVA Bus Reactor-2 Nos. (7x80 MVA, including one spare unit) • 765 kV Bus reactor bays-2 Nos. • 125 MVA Bus Reactor-2 Nos. • 400 kV Bus reactor bays- 2 Nos. • 220 kV line bays: 6 Nos. (for RE connectivity) • 400 kV line bays (for RE connectivity)- 3 Nos. • 400 kV Sectionalizer bay: 1 set • 220 kV Sectionalizer bay: 1 set • 220 kV BC (2 Nos.) bays and 220 kV TBC (2 Nos.) bays • 400 kV bays: 2 Nos. (for STATCOM) 	24 months from SPV transfer	100%	All Elements are required to be commissioned simultaneously as their utilization is dependent on each other.
2.	STATCOM (2x±300 MVA) along with MSC (4x125 MVA) and MSR (2x125 MVA) at Bikaner-IV PS			
3.	LILO of both ckts of Bikaner II PS- Bikaner III PS (Quad) direct 400 kV line at Bikaner-IV PS			
4.	Bikaner-IV PS – Siwani 765 kV D/C line along with 240 MVA switchable line reactor for each circuit at each end			

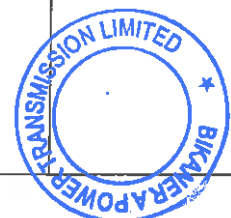

AD

	<ul style="list-style-type: none"> • 765 kV, 240 MVAr switchable line reactors at Bikaner-IV PS end– 2 Nos. • 765 kV, 240 MVAr switchable line reactors at Siwani S/s end– 2 Nos. • Switching equipment for 765 kV, 240 MVAr switchable line reactors at Bikaner-IV PS end – 2 Nos. • Switching equipment for 765 kV, 240 MVAr switchable line reactors at Siwani S/s end – 2 Nos. 			
5.	Siwani– Fatehabad (PG) 400 kV D/C line (Quad)			
6.	Siwani – Patran (Indi Grid) 400 kV D/C line (Quad) along with 80 MVAr switchable line reactor for each circuit at Siwani S/s end <ul style="list-style-type: none"> • 420 kV, 80 MVAr switchable line reactors at Siwani S/s end– 2 Nos. • Switching equipment for 420 kV, 80 MVAr switchable line reactors at Siwani S/s end – 2 Nos. • 400 kV GIS duct :700 m at Patran S/s 			
7.	2 Nos. 400 kV line bays each at Fatehabad (PG) and Patran (Indi Grid) GIS S/s <ul style="list-style-type: none"> • 400 kV line bays at Fatehabad (PG) S/s – 2 Nos. • 400 kV GIS line bays at Patran (Indi Grid) S/s – 2 Nos. 			
8.	2 Nos. 765 kV line bays at Siwani S/s			
9.	4 Nos. 400 kV line bays at Siwani S/s			

Note:

1. POWERGRID shall provide space for 2 Nos. of 400 kV line bays at Fatehabad (PG).IndiGrid shall provide space for 2 Nos. of 400 kV line bays (GIS) at Patran (Indi Grid) S/s.
2. Developer of Siwani S/s shall provide space for 2 Nos. of 765 kV line bays and 4 Nos. of 400 kV line bays at Siwani S/s.
2. That a company under the Companies Act 2013 by the name “**Bikaner A Power Transmission Limited**” having its registered office at New Delhi has been incorporated on 14.05.2024 by RECPDCL as its wholly owned subsidiary to initiate the activities for execution of the Project and subsequently to act as Transmission Service Provider (TSP) after being acquired by the successful bidder selected through Tariff Based Competitive Bidding process. A copy of the Certificate of Incorporation is enclosed and marked as **Annexure-2, (Page¹⁹ to Page¹⁹)** and a copy of the Memorandum of Association and Articles of Association is enclosed and marked as **Annexure-3, (Page²⁰ to Page⁵⁰)**.



3. BPC has initiated the selection of successful bidder to acquire the TSP in accordance with the "Tariff Based Competitive Bidding Guidelines for Transmission Service" and "Guidelines for Encouraging Competition in Development of Transmission Projects" issued by Government of India, Ministry of Power under section – 63 of The Electricity Act, 2003 and as amended from time to time. Copy of the Global Invitation for Qualification as published in the newspapers as furnished by BPC is enclosed and marked as **Annexure-4, (Page ...51... to Page 51.....)**.
4. That in the RFP documents, the following is stated
Quote
"The Transmission Charges shall be payable by the Designated ISTS Customers in Indian Rupees through the CTU as per Central Electricity Regulatory Commission (Sharing of Inter-State Transmission Charges and Losses) Regulations as amended from time to time.."
Unquote
Copy of the relevant extract of the RFP document issued by the BPC is enclosed and marked as **Annexure-5, (Page ...52.. to Page 53.....)** which are integral part of the RFP bidding documents furnished by BPC for bidding.
5. Subsequent to the process of competitive bidding conducted by the BPC, Power Grid Corporation of India Limited has been declared as the successful bidder. Copy of the Certificate by Bid Evaluation Committee report as furnished by BPC is enclosed and marked as **Annexure-6, (Page ...54... to Page 54.....)**. The Letter of Intent was issued to Power Grid Corporation of India Limited on 21.10.2024 by the BPC. A copy of the Letter of Intent (LoI) alongwith the details of Annual Transmission Charges is enclosed and marked as **Annexure-7, (Page ...55 to Page 61.....)**.
6. As per the provisions 2.15.2 of Request for Proposal (RFP) and the Letter of Intent issued to Power Grid Corporation of India Limited, within 10 days of issuance of Letter of Intent by the BPC, the Successful Bidder is required to inter-alia provide the Contract Performance Guarantee, execute Share Purchase Agreement & the Transmission Service Agreement and acquire the SPV. Vide letter dated 11.11.2024, the BPC in terms of provisio Clause 2.15.2 of RFP has extended the date upto 19.11.2024 for completion of activities by the successful bidder. A copy of the relevant extract of the RFP and the letter from BPC is enclosed and marked as **Annexure-8, (Page ...62 to Page 65.....)**.
7. That in accordance with the LoI, Power Grid Corporation of India Limited on 11.11.2024 furnished Contract Performance Guarantee of Rs 157.50 Crore (Rupees One Hundred Fifty-Seven Crore Fifty Lakh Only) in favour of Central Transmission Utility of India Limited (CTUIL).
8. A copy of the Transmission Service Agreement (TSA) entered between CTUIL and "**Bikaner A Power Transmission Limited**" is enclosed and marked as **Annexure-9, (Page ...66 to Page 301.....)**.

(Handwritten signature)



9. That the BPC vide letter dated 02.08.2024 had intimated to the bidders that the Acquisition Price payable by the Selected Bidder for Acquisition of one hundred percent of equity shareholding of Bikaner A Power Transmission Limited along with all its related assets and liabilities as Rs. 18,39,89,000/-. Subsequent to the bidding and during acquisition the BPC vide letter dated 07.11.2024 intimated the successful bidder - the applicant, the final Acquisition Price as Rs. 18,46,75,509/- with the following break-up:

Professional Fee of BPC incl GST.....	Rs. 17,70,00,000/-
Reimbursement of cost incurred by BPC incl GST.....	Rs. 71,75,509/-
Share Capital of Bikaner A Power Transmission Limited	Rs. 5,00,000 /-

Total	Rs. 18,46,75,509/-

That the Acquisition Price intimated earlier was Rs. 18,39,89,000/- (Rs. Eighteen Crore Thirty-Nine Lakh Eighty-Nine Thousand Only) and the revised Acquisition price intimated after the bidding by the Bid Process Coordinator is Rs. 18,46,75,509/- (Rs. Eighteen Crore Forty-Six Lakh Seventy Five Thousand Five Hundred and Nine Only) which is higher by Rs. 6,86,509/- than the amount intimated earlier. The aforesaid acquisition price of Rs. 18,46,75,509/- has been paid on 11.11.2024 to the RECPDCL.

A copy of the BPC letters dated 02.08.2024 and 07.11.2024 with regard to the increase in Acquisition Price is enclosed and marked as **Annexure – 10, (Page³⁰² to Page ³⁰⁴).**

10. Thereafter, Power Grid Corporation of India Limited has acquired the **Bikaner A Power Transmission Limited** on 11.11.2024 after execution of the Share Purchase Agreement, Transmission Service Agreement and completing all procedural requirements specified in the RFP documents. A copy of the Share purchase agreement is enclosed and marked as **Annexure –11 (Page ³⁰⁵..... to Page ³⁰⁴).**

11. The Applicant shall map Nodal Agency i.e. on the e-portal of this Hon'ble Commission at the earliest as per the procedure in vogue and completion of relevant formalities. The Applicant is also sending a copy of the present Application to CTUIL via e-mail. The Application is also being hosted on the website and is accessible on www.powergrid.in/subsidiaries and a copy of the Application is marked to CTUIL.

That a copy of the Application is marked to BPC to enable submission of the requisite documents / information by BPC before this Hon'ble Commission regarding the Bidding process undertaken and thereby ensure processing of application.

That a copy of the Application is marked to Designated ISTS Customers (DICs) and beneficiaries of the Northern Region as party to the Petition based on the list of the beneficiaries furnished by the CTUIL.



12. That a copy of SLD of the transmission scheme is enclosed and marked as **Annexure –12 (Page 325 to Page 325)**.
13. That POWERGRID has acquired the TSP on 11.11.2024 and the same is effective date of the project as per provisions of TSA. The schedule construction period of the project is 24 months. As such Scheduled CoD of the project works out to be 11.11.2026.
14. That **Bikaner A Power Transmission Limited** hereby submits this application under Section 63 of the Electricity Act, 2003 for Adoption of Transmission Charges to establish the Project under build, own, operate and transfer basis, which has been determined through transparent process of competitive bidding in accordance with the guidelines issued by the Central Government.
15. It is submitted that Section 63 of the Electricity Act, 2003 empowers the Appropriate Commission for Adoption of Transmission Charges.

Keeping in view the above, Hon'ble Commission may kindly adopt the Transmission Charges with respect to the Transmission System being established by the **Bikaner A Power Transmission Limited (a 100% wholly owned subsidiary of Power Grid Corporation of India Limited)**.

16. PRAYER

The applicant hereby humbly prays the Hon'ble Commission to:

- a) Adoption of Transmission Charges for Inter-State Transmission System for **“Transmission system for evacuation of power from Rajasthan REZ Ph-IV (Part-3: 6GW) [Bikaner complex]: Part A”** discovered through competitive bidding process.
- b) Allow the sharing and recovery of Transmission Charges for Inter-State Transmission System for **“Transmission system for evacuation of power from Rajasthan REZ Ph-IV (Part-3: 6GW) [Bikaner complex]: Part A”** as per Sharing of Inter-state Transmission Charges and Losses CERC Regulations 2020 and any other amendment thereon issued from time to time by CERC.
- c) Pass such other order / orders, as may be deemed fit and proper in the facts and circumstances of the case.

Bikaner A Power Transmission Limited
Applicant

Represented by **Naresh Kumar**
Finance Incharge, **Bikaner A Power Transmission Limited**

Place: New Delhi

Date: 11.11.2024

MINISTRY OF POWER

NOTIFICATION

New Delhi, the 14th March, 2024

S.O. 1364(E).—In exercise of the powers conferred by sub-para 3.2 of Para 3 of the Guidelines circulated under Section 63 of the Electricity Act, 2003 (No. 36 of 2003), the Central Government, on the recommendations of 18th meeting of National Committee on Transmission, hereby notifies the following transmission schemes under TBCB mode, with details of respective Bid-Process Coordinators (BPCs): -

Sl. No.	Name & Scope of the Transmission Scheme	Capacity (MVA) / Route Length (Km)						
1.	<p>Transmission system for evacuation of power from Rajasthan REZ Ph-IV (Part-3: 6 GW) [Bikaner complex] : Part A</p> <p>Tentative implementation time-frame: 24 months BPC: REC Power Development and Consultancy Limited Scope:</p> <table border="1"> <thead> <tr> <th>Sl. No.</th> <th>Scope of the Transmission Scheme</th> <th>Capacity (MVA) / Route Length (Km)</th> </tr> </thead> <tbody> <tr> <td>1.</td> <td> <p>Establishment of 6x1500 MVA, 765/400 kV & 6x500 MVA, 400/220 kV Bikaner-IV Pooling Station along with 2x240 MVAR (765kV) & 2x125 MVAR (420kV) Bus Reactors at a suitable location near Bikaner</p> <p>Future provisions at Bikaner-IV PS: Space for</p> <ul style="list-style-type: none"> ▪ 765 kV line bays along with switchable line reactors – 8 nos. ▪ 765kV Bus Reactor along with bay: 1 no. ▪ 400 kV line bays along with switchable line reactor –4 nos. ▪ 400 kV line bays–2 nos. ▪ 400/220kV ICT along with bays -4 nos. ▪ 400 kV Bus Reactor along with bay: 1 no. ▪ 400kV Sectionalizer bay: 1 set ▪ 220 kV line bays for connectivity of RE Applications -5 nos. ▪ 220kV Sectionalizer bay: 2 sets </td> <td> <p>Bikaner-IV PS -AIS</p> <ul style="list-style-type: none"> • 765/400 kV 1500 MVA ICTs- 6 Nos. (19x500 MVA including one spare unit) • 400/220 kV 500 MVA ICTs -6 Nos. • 765 kV line bays – 2 nos. (for 765 kV interconnection with Siwani S/s) • 400 kV line bays - 4 Nos.(For LILO of both ckts of Bikaner II PS- Bikaner III PS) • 765 kV ICT bays-6 Nos. • 400 kV ICT bays- 12 Nos. • 220 kV ICT bays- 6 Nos. • 240 MVAR Bus Reactor-2 Nos. (7x80 MVAR, including one spare unit) • 765 kV Bus reactor bays-2 Nos. • 125 MVAR Bus Reactor-2 Nos. • 400 kV Bus reactor bays- 2 Nos. • 220 kV line bays: 6 nos. (for RE connectivity) • 400kV line bays (for RE connectivity) - 3 nos. • 400kV Sectionalizer bay: 1 set • 220 kV Sectionalizer bay: 1 set • 220 kV BC (2 nos.) bays and 220 kV TB </td> </tr> </tbody> </table>	Sl. No.	Scope of the Transmission Scheme	Capacity (MVA) / Route Length (Km)	1.	<p>Establishment of 6x1500 MVA, 765/400 kV & 6x500 MVA, 400/220 kV Bikaner-IV Pooling Station along with 2x240 MVAR (765kV) & 2x125 MVAR (420kV) Bus Reactors at a suitable location near Bikaner</p> <p>Future provisions at Bikaner-IV PS: Space for</p> <ul style="list-style-type: none"> ▪ 765 kV line bays along with switchable line reactors – 8 nos. ▪ 765kV Bus Reactor along with bay: 1 no. ▪ 400 kV line bays along with switchable line reactor –4 nos. ▪ 400 kV line bays–2 nos. ▪ 400/220kV ICT along with bays -4 nos. ▪ 400 kV Bus Reactor along with bay: 1 no. ▪ 400kV Sectionalizer bay: 1 set ▪ 220 kV line bays for connectivity of RE Applications -5 nos. ▪ 220kV Sectionalizer bay: 2 sets 	<p>Bikaner-IV PS -AIS</p> <ul style="list-style-type: none"> • 765/400 kV 1500 MVA ICTs- 6 Nos. (19x500 MVA including one spare unit) • 400/220 kV 500 MVA ICTs -6 Nos. • 765 kV line bays – 2 nos. (for 765 kV interconnection with Siwani S/s) • 400 kV line bays - 4 Nos.(For LILO of both ckts of Bikaner II PS- Bikaner III PS) • 765 kV ICT bays-6 Nos. • 400 kV ICT bays- 12 Nos. • 220 kV ICT bays- 6 Nos. • 240 MVAR Bus Reactor-2 Nos. (7x80 MVAR, including one spare unit) • 765 kV Bus reactor bays-2 Nos. • 125 MVAR Bus Reactor-2 Nos. • 400 kV Bus reactor bays- 2 Nos. • 220 kV line bays: 6 nos. (for RE connectivity) • 400kV line bays (for RE connectivity) - 3 nos. • 400kV Sectionalizer bay: 1 set • 220 kV Sectionalizer bay: 1 set • 220 kV BC (2 nos.) bays and 220 kV TB 	
Sl. No.	Scope of the Transmission Scheme	Capacity (MVA) / Route Length (Km)						
1.	<p>Establishment of 6x1500 MVA, 765/400 kV & 6x500 MVA, 400/220 kV Bikaner-IV Pooling Station along with 2x240 MVAR (765kV) & 2x125 MVAR (420kV) Bus Reactors at a suitable location near Bikaner</p> <p>Future provisions at Bikaner-IV PS: Space for</p> <ul style="list-style-type: none"> ▪ 765 kV line bays along with switchable line reactors – 8 nos. ▪ 765kV Bus Reactor along with bay: 1 no. ▪ 400 kV line bays along with switchable line reactor –4 nos. ▪ 400 kV line bays–2 nos. ▪ 400/220kV ICT along with bays -4 nos. ▪ 400 kV Bus Reactor along with bay: 1 no. ▪ 400kV Sectionalizer bay: 1 set ▪ 220 kV line bays for connectivity of RE Applications -5 nos. ▪ 220kV Sectionalizer bay: 2 sets 	<p>Bikaner-IV PS -AIS</p> <ul style="list-style-type: none"> • 765/400 kV 1500 MVA ICTs- 6 Nos. (19x500 MVA including one spare unit) • 400/220 kV 500 MVA ICTs -6 Nos. • 765 kV line bays – 2 nos. (for 765 kV interconnection with Siwani S/s) • 400 kV line bays - 4 Nos.(For LILO of both ckts of Bikaner II PS- Bikaner III PS) • 765 kV ICT bays-6 Nos. • 400 kV ICT bays- 12 Nos. • 220 kV ICT bays- 6 Nos. • 240 MVAR Bus Reactor-2 Nos. (7x80 MVAR, including one spare unit) • 765 kV Bus reactor bays-2 Nos. • 125 MVAR Bus Reactor-2 Nos. • 400 kV Bus reactor bays- 2 Nos. • 220 kV line bays: 6 nos. (for RE connectivity) • 400kV line bays (for RE connectivity) - 3 nos. • 400kV Sectionalizer bay: 1 set • 220 kV Sectionalizer bay: 1 set • 220 kV BC (2 nos.) bays and 220 kV TB 						

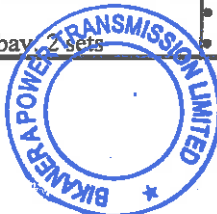

ATTESTED TRUE COPY
Attested from Pg 17 to Pg 18
Authorised Signatory
BIKANER A POWER TRANSMISSION LIMITED

	<ul style="list-style-type: none"> ▪ 220 kV BC (2 nos.) bays and 220 kV TBC (2 nos.) bays 	<ul style="list-style-type: none"> • nos.) bays • 400 kV bays: 2 Nos. (for STATCOM)
2.	STATCOM (2x+300MVA) along with MSC (4x125 MVA) & MSR (2x125 MVA) at Bikaner-IV PS	STATCOM (2x+300MVA) along with MSC (4x125 MVA) & MSR (2x125 MVA)
3.	LILO of both ckts of Bikaner II PS- Bikaner III PS (Quad) direct line at Bikaner-IV PS	Length -20 km (Quad) (LILO length)
4.	Bikaner-IV PS – Siwani 765 kV D/c line along with 240 MVA switchable line reactor for each circuit at each end	Line Length -260 km <ul style="list-style-type: none"> • 765 kV, 240 MVA switchable line reactors at Bikaner-IV PS end- 2 Nos. • 765 kV, 240 MVA switchable line reactors at Siwani S/s end- 2 Nos. • Switching equipment for 765kV, 240 MVA switchable line reactors at Bikaner-IV PS end - 2 Nos. • Switching equipment for 765kV, 240 MVA switchable line reactors at Siwani S/s end - 2 Nos.
5.	Siwani- Fatehabad (PG) 400 kV D/c line (Quad)	Line Length ~80 km (Quad)
6.	Siwani – Patran (Indi Grid) 400 kV D/c line (Quad) along with 80 MVA switchable line reactor for each circuit at Siwani S/s end	Line Length -160 km (Quad) <ul style="list-style-type: none"> • 420 kV, 80 MVA switchable line reactors at Siwani S/s end- 2 Nos. • Switching equipment for 420kV, 80 MVA switchable line reactors at Siwani S/s end - 2 Nos. • 400 kV GIS duct :700 m at Patran S/s
7.	2nos. 400 kV line bays each at Fatehabad (PG) & Patran (Indi Grid) S/s	<ul style="list-style-type: none"> • 400 kV line bays at Fatehabad (PG) S/s - 2 Nos. • 400 kV line bays at Patran (Indi Grid) S/s - 2 nos.
8.	2nos. 765 kV line bays at Siwani S/s	• 765 kV line bays at Siwani S/s - 2 Nos.
9.	4 nos. 400 kV line bays at Siwani S/s	• 400 kV line bays at Siwani S/s - 4 Nos. (for 400kV interconnections)

2. Transmission system for evacuation of power from Rajasthan REZ Ph-IV (Part-3: 6 GW) [Bikaner complex] : Part B

Tentative Implementation Time: 24 months

BPC: REC Power Development and Consultancy Limited

Scope:

Sl. No.	Scope of the Transmission Scheme	Capacity (MVA)/ Route Length (Km)
1.	Establishment of 765/400kV, 6x1500 MVA S/s at suitable location near Siwani (Distt. Bhiwani) along with 2x240 MVA (765kV) Bus Reactor & 2x125 MVA (420kV) Bus Reactor Future provisions at Siwani S/s: Space for <ul style="list-style-type: none"> ▪ 765 kV line bays along with switchable line reactors - 8 ▪ 765kV Bus Reactor along with bay: 1 nos. ▪ 400 kV line bays along with switchable line reactor - 8 nos. ▪ 400 kV Bus Reactor along with bays: 1 no. ▪ 400kV Sectionalizer bay: 1 set 	Siwani S/s- AIS <ul style="list-style-type: none"> • 765/400 kV 1500 MVA ICTs- 6 nos. (19x500 MVA including one spare unit) • 765 kV ICT bays-6 no. • 400 kV ICT bays- 6 no. • 765 kV line bays - 2 nos. (for 765kV interconnection with Bikaner-IV PS) • 400 kV line bays - 4 nos. (for 400kV interconnections) • 240 MVA Bus Reactor-2 no. (7x80 MVA, including one spare unit) • 765 kV Bus reactor bays-2 no. • 125 MVA Bus Reactor-2 nos. • 400 kV Bus reactor bays- 2 nos. • 400kV Sectionalizer bay: 1 set • 400kV bays : 2 nos. (for STATCOM)
2.	Bikaner-IV PS – Siwani 765 kV D/c (2 nd) line along with 240 MVA switchable line reactor for each circuit at each end	Line Length -260 km <ul style="list-style-type: none"> • 765 kV, 240 MVA switchable line reactors at Bikaner-IV PS end- 2 nos. • 765 kV, 240 MVA switchable line reactors at Siwani S/s end- 2 nos.

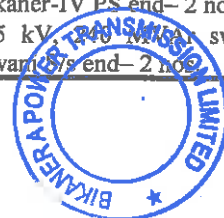

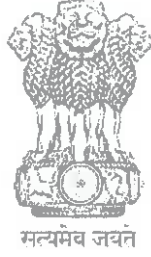

**GOVERNMENT OF INDIA
MINISTRY OF CORPORATE AFFAIRS**

Central Registration Centre

Certificate of Incorporation

[Pursuant to sub-section (2) of section 7 and sub-section (1) of section 8 of the Companies Act, 2013 (18 of 2013) and rule 18 of the Companies (Incorporation) Rules, 2014]

I hereby certify that BIKANER A POWER TRANSMISSION LIMITED is incorporated on this FOURTEENTH day of MAY TWO THOUSAND TWENTY FOUR under the Companies Act, 2013 (18 of 2013) and that the company is Company limited by shares

The Corporate Identity Number of the company is **U42202DL2024GOI431226**

The Permanent Account Number (PAN) of the company is **AAMCB5917C***

The Tax Deduction and Collection Account Number (TAN) of the company is **DELB28639C***

Given under my hand at Manesar this FOURTEENTH day of MAY TWO THOUSAND TWENTY FOUR

Signature Not Verified

Digitally signed by
DS MINISTRY OF CORPORATE
AFFAIRS , CRC MANESAR 1
Date: 2024.05.15 12:16:29 IST

afsar Ali

Assistant Registrar of Companies/ Deputy Registrar of Companies/ Registrar of Companies

For and on behalf of the Jurisdictional Registrar of Companies

Registrar of Companies

Central Registration Centre

Disclaimer: This certificate only evidences incorporation of the company on the basis of documents and declarations of the applicant(s). This certificate is neither a license nor permission to conduct business or solicit deposits or funds from public. Permission of sector regulator is necessary wherever required. Registration status and other details of the company can be verified on mca.gov.in

Mailing Address as per record available in Registrar of Companies office:

BIKANER A POWER TRANSMISSION LIMITED

CORE-4, SCOPE COMPLEX, 7, LODHI ROAD, Lodi Road, New Delhi, South Delhi, 110003, Delhi

*as issued by Income tax Department

19



Form No. INC-33



Form language

English Hindi

e-MOA (e-Memorandum of Association)
[Pursuant to Schedule I (see Sections 4 and 5) to
the Companies Act, 2013]

Refer instruction kit for filling the form

All fields marked in * are mandatory

*** Table applicable to company as notified under schedule I of the Companies Act, 2013**

- (A - MEMORANDUM OF ASSOCIATION OF A COMPANY LIMITED BY SHARES
- B - MEMORANDUM OF ASSOCIATION OF A COMPANY LIMITED BY GUARANTEE AND NOT HAVING A SHARE CAPITAL
- C - MEMORANDUM OF ASSOCIATION OF A COMPANY LIMITED BY GUARANTEE AND HAVING A SHARE CAPITAL
- D - MEMORANDUM OF ASSOCIATION OF AN UNLIMITED COMPANY AND NOT HAVING SHARE CAPITAL
- E - MEMORANDUM OF ASSOCIATION OF AN UNLIMITED COMPANY AND HAVING SHARE CAPITAL)

A - MEMORANDUM OF
ASSOCIATION OF A COMPANY
LIMITED BY SHARES

Table A/B/C/D/E

1 The name of the company is

BIKANER A POWER
TRANSMISSION LIMITED

2 The registered office of the company will be situated in the State of

Delhi

3 (a) The objects to be pursued by the company on its incorporation are:

1. To plan, promote and develop an integrated and efficient power transmission system network in all its aspects including planning, investigation, research, design and engineering, preparation of preliminary, feasibility and definite project reports, construction, operation and maintenance of transmission lines, sub-stations, load dispatch stations and communication facilities and appurtenant works, coordination of integrated operation of regional and national grid system, execution of turn-key jobs for other utilities/organizations and wheeling of power in accordance with the policies, guidelines and objectives laid down by the Central Government from time to time.
2. To study, investigate, collect information and data, review operation, plan, research, design and prepare Report, diagnose operational difficulties and weaknesses and advise on the remedial measures to improve,

ATTESTED TRUE COPY
Attested from Pg 20 to Pg 32
Authorised Signatory
BIKANER A POWER TRANSMISSION LIMITED

20



undertake development of new and innovative product connected with business of the Company as well as modernize existing EHV, HV lines and Sub-Stations.

3.To act as consultants, technical advisors, surveyors and providers of technical and other services to Public or Private Sector enterprises engaged in the planning, investigation, research, design and preparations of preliminary, feasibility and definite project reports, manufacture of power plant and equipment, construction, generation, operation and maintenance of power transmission system from power generating stations and projects, transmission and distribution of power.

4.To plan, promote, develop, erect and maintain, operate and otherwise deal in Telecommunication networks and services in all its aspects including planning, investigation, research, design and engineering, preparation of preliminary, feasibility and definite project reports: to purchase, sell, import, export, assemble, manufacture, install, commission, maintain, operate commercially whether on own or along with other, on lease or otherwise. These networks and for such purposes to set up and/ or install all requisite communications facilities and other facilities including fibre optic links, digital microwave links, communication cables, other telecommunication means, telephone and other exchanges, co-axial stations, microwave stations, repeater stations, security system databases, billing systems, subscriber management systems and other communication systems whether consisting of sound, visual impulse, or otherwise, existing or that may be developed or invented in the future and to manufacture, purchase, sell, import, export, assemble, take or give on lease/rental/subscription



basis or by similar means or otherwise deal in all components and other support and ancillary hardware and software systems, accessories, parts and equipments etc. used in or in connection with the operation of the above communication systems and networks including to deal with telecommunication operations or directly with the general public, commercial companies or otherwise.

(b) *Matters which are necessary for furtherance of the objects specified in clause 3(a) are

1.To obtain license, approvals and authorization from Governmental Statutory and Regulatory Authorities, as may be necessary to carry out and achieve the Objects of the Company and connected matters which may seem expedient to develop the business interests of the Company in India and abroad.

2.To enter into any arrangement with the Government of India or with any State Government or with other authorities/ commissions, local bodies or public sector or private sector undertakings, Power Utilities, Financial Institutions, Banks, International Funding Agencies and obtain such charters, subsidies, loans, advances or other money, grants, contracts, rights, sanctions, privileges, licenses or concessions whatsoever (whether statutory or otherwise) which the Company may think it desirable to obtain for carrying its activities in furthering the interests of the Company or its members.

3.To enter into any agreement, contract or any arrangement for the implementation of the power generation, evacuation, transmission and distribution system and network with Power/ Transmission Utilities, State Electricity Boards, Vidhyut Boards, Transmission Companies, Generation Companies, Licensees, Statutory bodies,



other organizations (whether in Private, Public or Joint Sector Undertaking) and bulk consumers of power etc.

4.To secure the payments of money, receivables on transmission and distribution of electricity and sale of fuel, as the case may be, to the State Electricity Boards, Vidyut Boards, Transmission Utilities, Generating Companies, Transmission Companies, Distribution Companies, State Governments, Licensees, statutory bodies, other organizations (whether in Private, Public or Joint Sector Undertaking) and bulk consumers of power etc. through Letter of Credits/ESCROW and other security documents.

5.To coordinate with the Central Transmission Utility of electricity generated by it under the relevant provisions of Electricity Act 2003 and any amendments thereto.

6.Subject to provisions of Sections 73, 74, 179, 180 & 186 and other applicable provisions of the Companies Act, 2013 and rules made thereunder and subject to other laws or directives, if any, of SEBI/RBI, to borrow money in Indian rupees or foreign currencies and obtain foreign lines of credits/ grants/ aids etc. or to receive money or deposits from public for the purpose of the Company's business in such manner and on such terms and with such rights, privileges and obligations as the Company may think fit. The Company may issue bonds/ debentures whether secured or unsecured; bills of exchange, promissory notes or other securities, mortgage or charge on all or any of the immovable and movable properties, present or future and all or any of the uncalled capital for the time being of the Company as the Company may deem fit and To repay, redeem or pay off any such securities or charges.

7.To lend money on property or on mortgage of immovable properties or against Bank



guarantee and to make advances of money against future supply of goods and services on such terms as the Directors may consider necessary and to invest money of the Company in such manner as the Directors may think fit and to sell, transfer or to deal with the same.

8. To own, possess, acquire by purchase, lease or otherwise rights, title and interests in and to, exchange or hire real estate, equipment, Transmission lines, lands, buildings, apartments, plants, equipment, machinery, fuel blocks and hereditaments of any tenure or descriptions situated in India or abroad or any estate or interest therein and any right over or connected with land so situated and turn the same to account in any manner as may seem necessary or convenient for the purpose of business of the Company and to hold, improve, exploit, reorganize, manage, lease, sell, exchange or otherwise dispose of the whole or any part thereof.

9. Subject to applicable provisions of Companies Act, 2013, to subscribe for, underwrite, or otherwise acquire, hold, dispose of and deal with the shares, stocks, debentures or other securities and titles of indebtedness or the right to participate in profits or other similar documents issued by any Government authority, Corporation or body or by any company or body of persons and any option or right in respect thereof.

10. To create any depreciation fund, reserve fund, sinking fund, insurance fund, gratuity, provident fund or any other fund, for depreciation or for repairing, improving extending or maintaining any of the properties of the Company or for any other purposes whatsoever conducive to the interests of the Company.

11. To acquire shares, stocks, debentures or securities of any company carrying on any



business which this Company is entitled to carry on or acquisition of undertaking itself which may seem likely or calculated to promote or advance the interests of the Company and to sell or dispose of or transfer any such shares, stocks or securities and the acquired undertaking.

12. To enter into partnership or into any agreement for joint working, sharing or pooling profits, joint venture, amalgamation, union of interests, co-operation, reciprocal concessions or otherwise or amalgamate with any person or company carrying on or engaged in or about to carry on or engaged in any business or transaction in India or abroad which the Company is authorized to carry on or engage in any business undertaking having objects identical or similar to, as are being carried on by this Company.

13. To establish and maintain agencies, branch offices and local agencies, to procure business in any part of India and world and to take such steps as may be necessary to give the Company such rights and privileges in any part of the world as deemed proper in the interest of the Company.

14. To promote and undertake the formation of any institution or Company or subsidiary company or for any aforesaid objects intended to benefit the Company directly or indirectly and to coordinate, control and guide their activities.

15(a). To negotiate and enter into agreements and contracts with domestic and foreign companies,

persons or other organizations, banks and financial institutions, in relation to the business of the Company including that of technical know-how, import, export, purchase or sale of plant, machinery, equipment, tools, accessories and consumables, financial assistance and for carrying out all or any of the objects of the Company.



15(b). To negotiate and enter into agreements and contracts for execution of turnkey jobs, works, supplies and export of plant, machinery, tools and accessories etc.

16. Upon and for the purpose of any issue of shares, debentures or any other securities of the Company, to enter into agreement with intermediaries including brokers, managers of issue/commission agents and underwriters and to provide for the remuneration of such persons for their services by way of payment in cash or issue of shares, debentures or other securities of the Company or by granting options to take the same or in any other manner as permissible under the law.

17. To enter into contracts of indemnity and get guarantee and allocations for the business of the Company.

18. To make arrangements for training of all categories of employees and to employ or otherwise engage experts, advisors, consultants etc. in the interest of achieving the Company's objects.

19. To promote conservation and protection of electricity from theft, safety of life and to protect environments including air, land and water etc.

20. To pay and provide for the remuneration, amelioration and welfare of persons employed or formerly employed by the Company and their families providing for pension, allowances, bonuses, other payments or by creating for the purpose from time to time the Provident Fund, Gratuity and other Funds or Trusts. Further to undertake building or contributing to the building or houses, dwellings or chawls by grants of money, or by helping persons employed by the Company to effect or maintain insurance on their lives by contributing to the payment of premium or otherwise and by providing or subscribing or

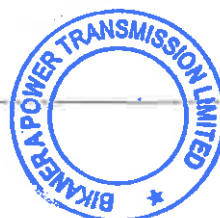

contributing towards educational institutions, recreation, hospitals and dispensaries, medical and other assistance as the Company may deem fit.

21. To ensure any rights, properties, undertakings, contracts, guarantees or obligations or profits of the Company of every nature and kind in any manner with any person, firm, association, institution or company.

22. To distribute among members of the Company dividend including bonus shares out of profits, accumulated profits or funds and resources of the Company in any manner permissible under law.

23. To institute, conduct, defend, compound or abandon any legal proceedings by or against the Company or its officers or otherwise concerning the affairs of the Company and also to compound and to allow time for payment or satisfaction of any debts or recovery due, claims or demands by or against the Company and to refer any claims or demands by or against the Company or any differences arising in execution of contracts to conciliation and arbitration and to observe, comply with and/or challenge any awards preliminary, interim or final made in any such arbitration.

24. To pay out of the funds of the Company all costs, charges, expenses and preliminary and incidental to the promotion, formation, establishment and registration of the Company or other expenses incurred in this regard.

25. Subject to provisions of Sections 181, 182 & 183 of Companies Act, 2013 to contribute money or otherwise assist to charitable, benevolent, religious, scientific national, defense, public or other institutions or objects or purposes.

26. To open an account or accounts with any individual,



firm or company or with any bank bankers or shroofs and to pay into and withdraw money from such account or accounts.

27.To accept gifts, bequests, devises and donations from members and others and to make gifts to members and others of money, assets and properties of any kind.

28.To carry out all or any of the objects of the company and do all or any of the above things in any part of the world and either as principal, agent, contractor or trustee or otherwise and either alone or in conjunction with others.

29.To negotiate and/or enter into agreement and contract with individuals, companies, corporations, foreign or Indian, for obtaining or providing technical, financial or any other assistance for carrying on all or any of the objects of the Company and also for the purpose of activating, research, development of projects on the basis of know-how and/or financial participation and for technical collaboration, and to acquire or provide necessary formulate and patent rights for furthering the objects of the company.

30.To aid peculiarly or otherwise, any association, body or movement having for its object the solution, settlement or surmounting of industrial or labour problems or trouble or the promotion of industry or trade.

31.Subject to the provisions of Companies Act, 2013 or any amendment or re-enactment thereof in the event of winding up to distribute among the members in specie any property of the Company or any proceeds of sale on disposal of any property in accordance with the provisions of the Act.

32.To do all such other things as may be deemed incidental or conducive to the attainment of the above Objects or any of them and to carry on any business which may seem to the Company



capable of being conveniently carried in connection with any of the Company's Objects or calculated directly or indirectly to enhance the value of or render profitable any of the Company's property or rights.

33. To establish, provide, maintain and conduct or otherwise subsidize research laboratories and experimental workshops for scientific, technical or researches, experiments and to undertake and carry on directly or in collaboration with other agencies scientific and technical research experiments and tests of all kinds and to process, improve and invent new products and their techniques of manufacture and to promote, encourage, reward in every manner studies and research, scientific and technical investigations and inventions of any kind that may be considered likely to assist, encourage and promote rapid advances in technology, economies, import substitution or any business which the Company is authorized to carry on.

34. Subject to provisions of the Companies Act, 2013, to evolve scheme for restructuring or arrangement, to amalgamate or merge or to enter into partnership or into any consortium or arrangement for sharing of profits, union of interests, co-operation, joint venture with any Person or Persons, partnership firm/firms, or company or companies carrying on or engaged in any operation capable of being conducted so conveniently in cooperation with the business of the Company or to benefit the Company or to the activities for which the Company has been established.

35. To apply for purchase, or otherwise acquire any trade marks, patents, brevets, inventions, licenses, concessions and the like, conferring any exclusive or nonexclusive or



limited rights to use, or any secret or other information as to any invention which may be capable of being used for any of the purposes of the Company, or the acquisition of which may benefit the Company and to use, exercise, develop or grant licenses in respect of or otherwise turn to account the property, rights or information so acquired.

36. To sell, dispose or hive off an undertaking of the Company or any part thereof for such consideration as the Company may think fit and in particular for shares, debentures or securities of any other association, corporation or company.

37. To sell, improve, manage, develop, exchange, loan, lease or let, under-lease, sub - let, mortgage, dispose of, deal with in any manner, turn to account or otherwise deal with any rights or property of the Company.

4 The liability of the member(s) is limited, and this liability is limited to the amount unpaid if any, on the shares held by them.

5 Every member of the company undertakes to contribute:

(i) to the assets of the company in the event of its being wound up while he is a member, or within one year after he ceases to be a member, for payment of the debts and liabilities of the company or of such debts and liabilities as may have been contracted before he ceases to be a member; and

(ii) to the costs, charges and expenses of winding up (and for the adjustment of the rights of the contributories among

themselves), such amount as may be required, not exceeding * _____ rupees.

(iii) The share capital of the company is 500000 rupees, divided into

50000	Equity Share	Shares of	10	Rupees each	
-------	--------------	-----------	----	-------------	--

6 We, the several persons, whose names and address are subscribed, are desirous of being formed into a company in pursuance of this memorandum of association, and we respectively agree to take the number of shares in the capital of the company set against our respective names:



I, whose name and address is given below, am desirous of forming a company in pursuance of this memorandum of association and agree to take all the shares in the capital of the company:

We, the several persons, whose names and addresses are subscribed, are desirous of being formed into a company in pursuance of this memorandum of association:

Subscriber Details					
S. No.	*Name, Address, Description and Occupation	DIN / PAN / Passport number	No. of shares taken	DSC	Dated
1	ARVIND KUMAR S/O NAND KISHOR SINGH NOMINEE OF REC POWER DEVELOPMENT AND CONSULTANCY LIMITED R/O T4-8A, SAI VATIKA APARTMENT, SECTOR-63, FARIDABAD - 121004, OCCUPATION-SERVICE	1*3*2*3*	1 Equity,0 Preference	ARVIND KUMAR	10/05/2024
2	REC POWER DEVELOPMENT AND CONSULTANCY LIMITED, CORE-4, SCOPE COMPLEX, 7, LODHI ROAD, NEW DELHI-110003, THROUGH ITS CEO RAJESH KUMAR S/O SHRINIWAS GUPTA R/O L-187, NAG MANDIR KE PAS SHASTRI NAGAR, ASHOK VIHAR, DELHI-110052, OCCUPATION-SERVICE	0*9*1*2*	49994 Equity,0 Preference	RAJESH KUMAR	10/05/2024
3	PUTHIYARKATTU SHIVARAMAN HARIHARAN S/O SHRI PUTHIYARAKAT VELAYUDHAN SIVARAMAN NOMINEE OF REC POWER DEVELOPMENT AND CONSULTANCY LIMITED FLAT NO.104, SADAR APARTMENT, MAYUR VIHAR EXTENTION, PHASE-1, PLOT NO.9, NEW DELHI-110091, OCCUPATION-SERVICE	0*6*7*5*	1 Equity,0 Preference	P S HARIHARAN	10/05/2024
4	ANIL KUMAR PERALA S/O VENKATESHAM NOMINEE OF REC POWER DEVELOPMENT AND CONSULTANCY LIMITED R/O A302 TARIKA APPARTMENT, SECTOR-43 GURGAON HARYANA-122001 OCCUPATION-SERVICE	B*V*P*1*2*	1 Equity,0 Preference	Perala Anil Kumar	10/05/2024
5	THANGARAJAN SUBASH CHANDIRA BOSH S/O SHRI SITHAN THANGARAJAN NOMINEE OF REC POWER DEVELOPMENT AND CONSULTANCY LIMITE D R/O APARTMENT NO S-2, MIDDLE PORTION 2-B, JANGPURA, MATHURA ROAD, NEW DELHI-110014, OCCUPATION-SERVICE	0*7*2*1*	1 Equity,0 Preference	Thangarajan Subash Chandira Bosh	10/05/2024

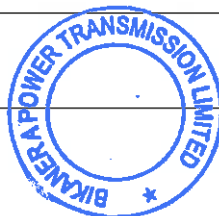

6	MUKUL AGARWAL S/O SHRI RAJESH KUMAR NOMINEE OF REC POWER DEVELOPMENT AND CONSULTANCY LIMITED R/O HOUSE NO. 767, SECOND FLOOR ANSAL C-2 BLOCK, NEAR WATER TANK ANSAL PLAZA, SECTOR-3 PALAM VIHAR, GURGAON-122017, HARYANA, OCCUPATION-SERVICE	1*3*2*8*	1 Equity,0 Preference	MUKUL AGARWAL	10/05/2024
7	SATYABAN SAHOO S/O MAHENDRANATH SAHOO NOMINEE OF REC POWER DEVELOPMENT AND CONSULTANCY LIMITED R/O FLAT NO. B235 VASANT APPARTMENT GURGAON HARYANA-122001 OCCUPATION-SERVICE	A*K*S*0*9*	1 Equity,0 Preference	Satyaban Sahoo	10/05/2024
Total shares taken			50000 Equity,0 Preference		

Signed before me

Membership type of the witness (ACA/FCA/ACS/FCS/ACMA/FCMA)	*Name of the witness	*Address, Description and Occupation	DIN / PAN / Passport number / Membership number	DSC	Dated
FCA	VINAY KUMAR	A-805, NX BYTE T-3,NX ONE, TECHZONE-IV, GREATER NOIDA WEST-201318	4*2*9*	Vinay Kumar	10/05/2024

7 Shri / Smt

aged

Of

resident of

years shall be the nominee in the event of death of the sole member.

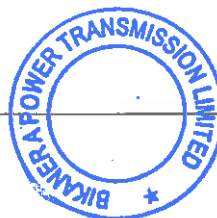

Form No. INC-34



Form language

e-AOA (e-Articles of Association)

English Hindi

[Pursuant to Section 5 of the Companies Act, 2013 and rules made thereunder read with Schedule I]

Refer instruction kit for filling the form.

All fields marked in * are mandatory

Table applicable to company as notified under schedule I of the Companies Act, 2013 (F, G, H)

F

F - A COMPANY LIMITED BY SHARES

BIKANER A POWER TRANSMISSION LIMITED

Table F / G / H (basis on the selection of above-mentioned field) as notified under schedule I of the companies Act, 2013 is applicable to
(F - a company limited by shares
G - a company limited by guarantee and having a share capital
H - a company limited by guarantee and not having share capital)

The name of the company is

Check if not applicable	Check If altered	Article No.	Description
			Interpretation
<input type="checkbox"/>	<input checked="" type="checkbox"/>	I	<ul style="list-style-type: none">(1) In these regulations- (a) the Act means the Companies Act 2013 (b) the seal means the common seal of the company. (2) Unless the context otherwise requires words or expressions contained in these regulations shall bear the same meaning as in the Act or any statutory modification thereof in force at the date at which these regulations become binding on the company. (3) Public company means a company which- (a) is not a private company (b) has a minimum paid-up share capital as maybe prescribed Provided that a company which is a subsidiary of a company not being a private company shall be deemed to be public company for the purposes of this Act even where such subsidiary company continues to be a private company in its articles.
			Share Capital and Variation of rights
<input type="checkbox"/>	<input type="checkbox"/>	II 1	<ul style="list-style-type: none">Subject to the provisions of the Act and these Articles the shares in the capital of the company shall be under the control of the Directors who may issue allot or otherwise dispose of the same or any of them to such persons in such proportion and on such terms and conditions and either at a premium or at par and at such time as they may from time to time think fit.Every person whose name is entered as a member in the register

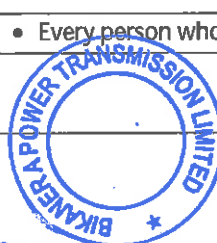

ATTESTED TRUE COPY
Attested from Pg 33 to 49 50
Page 1 of 17
Authorised Signatory
BIKANER A POWER TRANSMISSION LIMITED

83

<input type="checkbox"/>	<input checked="" type="checkbox"/>	<p>2</p>	<p>of members shall be entitled to receive within two months after incorporation in case of subscribers to the memorandum or after allotment or within one month after the application for the registration of transfer or transmission or within such other period as the conditions of issue shall be provided one certificate for all his shares without payment of any charges or several certificates each for one or more of his shares upon payment of twenty rupees for each certificate after the first. Every certificate shall be under the seal and shall specify the shares to which it relates and the amount paid - up thereon. In respect of any share or shares held jointly by several persons the company shall not be bound to issue more than one certificate and delivery of certificate for a share to one of several joint holders shall be sufficient delivery to all such holders.</p>
<input type="checkbox"/>	<input type="checkbox"/>	<p>3</p>	<ul style="list-style-type: none"> • If any share certificate be worn out defaced mutilated or torn or if there be no further space on the back for endorsement of transfer then upon production and surrender thereof to the company a new certificate may be issued in lieu thereof and if any certificate is lost or destroyed then upon proof thereof to the satisfaction of the company and on execution of such indemnity as the company deem adequate a new certificate in lieu thereof shall be given. Every certificate under this Article shall be issued on payment of twenty rupees for each certificate. The provisions of Articles (2) and (3) shall mutatis mutandis apply to debentures of the company.
<input type="checkbox"/>	<input type="checkbox"/>	<p>4</p>	<ul style="list-style-type: none"> • Except as required by law no person shall be recognised by the company as holding any share upon any trust and the company shall not be bound by or be compelled in any way to recognise (even when having notice thereof) any equitable contingent future or partial interest in any share or any interest in any fractional part of a share or (except only as by these regulations or by law otherwise provided) any other rights in respect of any share except an absolute right to the entirety thereof in the registered holder.
<input type="checkbox"/>	<input type="checkbox"/>	<p>5</p>	<ul style="list-style-type: none"> • The company may exercise the powers of paying commissions conferred by sub-section (6) of section 40 provided that the rate per cent or the amount of the commission paid or agreed to be paid shall be disclosed in the manner required by that section and rules made thereunder. The rate or amount of the commission shall not exceed the rate or amount prescribed in rules made under sub-section (6) of section 40. The commission may be satisfied by the payment of cash or the allotment of fully or partly paid shares or partly in the one way and partly in the other.
<input type="checkbox"/>	<input type="checkbox"/>	<p>6</p>	<ul style="list-style-type: none"> • If at any time the share capital is divided into different classes of shares the rights attached to any class (unless otherwise provided by the terms of issue of the shares of that class) may subject to the provisions of section 48 and whether or not the company is being wound up be varied with the consent in writing of the holders of three-fourths of the issued shares of that class or with the sanction of a special resolution passed at a separate meeting of the holders of the shares of that class. To every such separate meeting the provisions of these regulations relating to general meetings shall mutatis mutandis apply but so that the necessary quorum shall be at least two persons holding at least one-third of the issued shares

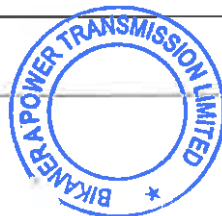

34

			of the class in question.
<input type="checkbox"/>	<input type="checkbox"/>	7	<ul style="list-style-type: none"> The rights conferred upon the holders of the shares of any class issued with preferred or other rights shall not unless otherwise expressly provided by the terms of issue of the shares of that class be deemed to be varied by the creation or issue of further shares ranking pari passu therewith.
<input type="checkbox"/>	<input type="checkbox"/>	8	<ul style="list-style-type: none"> Subject to the provisions of section 55 any preference shares may with the sanction of an ordinary resolution be issued on the terms that they are to be redeemed on such terms and in such manner as the company before the issue of the shares may by special resolution determine.
			Lien
<input type="checkbox"/>	<input type="checkbox"/>	9	<ul style="list-style-type: none"> The company shall have a first and paramount lien on every share (not being a fully paid share) for all monies (whether presently payable or not) called or payable at a fixed time in respect of that share and on all shares (not being fully paid shares) standing registered in the name of a single person for all monies presently payable by him or his estate to the company Provided that the Board of directors may at any time declare any share to be wholly or in part exempt from the provisions of this clause. The company's lien if any on a share shall extend to all dividends payable and bonuses declared from time to time in respect of such shares.
<input type="checkbox"/>	<input type="checkbox"/>	10	<ul style="list-style-type: none"> The company may sell in such manner as the Board thinks fit any shares on which the company has a lien Provided that no sale shall be made unless a sum in respect of which the lien exists is presently payable or b until the expiration of fourteen days after a notice in writing stating and demanding payment of such part of the amount in respect of which the lien exists as is presently payable has been given to the registered holder for the time being of the share or the person entitled thereto by reason of his death or insolvency.
<input type="checkbox"/>	<input type="checkbox"/>	11	<ul style="list-style-type: none"> To give effect to any such sale the Board may authorise some person to transfer the shares sold to the purchaser thereof The purchaser shall be registered as the holder of the shares comprised in any such transfer. The purchaser shall not be bound to see to the application of the purchase money nor shall his title to the shares be affected by any irregularity or invalidity in the proceedings in reference to the sale.
<input type="checkbox"/>	<input type="checkbox"/>	12	<ul style="list-style-type: none"> The proceeds of the sale shall be received by the company and applied in payment of such part of the amount in respect of which the lien exists as is presently payable. The residue if any shall subject to a like lien for sums not presently payable as existed upon the shares before the sale be paid to the person entitled to the shares at the date of the sale.
			Calls on shares
<input type="checkbox"/>	<input type="checkbox"/>		<ul style="list-style-type: none"> The Board may from time to time make calls upon the members in respect of any monies unpaid on their shares (whether on account

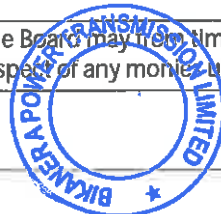

		13	of the nominal value of the shares or by way of premium) and not by the conditions of allotment thereof made payable at fixed times Provided that no call shall exceed one-fourth of the nominal value of the share or be payable at less than one month from the date fixed for the payment of the last preceding call. Each member shall subject to receiving at least fourteen days notice specifying the time or times and place of payment pay to the company at the time or times and place so specified the amount called on his shares. A call may be revoked or postponed at the discretion of the Board.
<input type="checkbox"/>	<input type="checkbox"/>	14	<ul style="list-style-type: none"> A call shall be deemed to have been made at the time when the resolution of the Board authorizing the call was passed and may be required to be paid by instalments.
<input type="checkbox"/>	<input type="checkbox"/>	15	<ul style="list-style-type: none"> The joint holders of a share shall be jointly and severally liable to pay all calls in respect thereof.
<input type="checkbox"/>	<input type="checkbox"/>	16	<ul style="list-style-type: none"> If a sum called in respect of a share is not paid before or on the day appointed for payment thereof the person from whom the sum is due shall pay interest thereon from the day appointed for payment thereof to the time of actual payment at ten per cent per annum or at such lower rate if any as the Board may determine. The Board shall be at liberty to waive payment of any such interest wholly or in part.
<input type="checkbox"/>	<input type="checkbox"/>	17	<ul style="list-style-type: none"> Any sum which by the terms of issue of a share becomes payable on allotment or at any fixed date whether on account of the nominal value of the share or by way of premium shall for the purposes of these regulations be deemed to be a call duly made and payable on the date on which by the terms of issue such sum becomes payable. In case of non-payment of such sum all the relevant provisions of these regulations as to payment of interest and expenses forfeiture or otherwise shall apply as if such sum had become payable by virtue of a call duly made and notified.
<input type="checkbox"/>	<input type="checkbox"/>	18	<ul style="list-style-type: none"> The Board - a. may if it thinks fit receive from any member willing to advance the same all or any part of the monies uncalled and unpaid upon any shares held by him and b. upon all or any of the monies so advanced may (until the same would but for such advance become presently payable) pay interest at such rate not exceeding unless the company in general meeting shall otherwise direct twelve per cent per annum as may be agreed upon between the Board and the member paying the sum in advance.
			Transfer of shares
<input type="checkbox"/>	<input type="checkbox"/>	19	<ul style="list-style-type: none"> The instrument of transfer of any share in the company shall be executed by or on behalf of both the transferor and transferee. The transferor shall be deemed to remain a holder of the share until the name of the transferee is entered in the register of members in respect thereof.
<input type="checkbox"/>	<input type="checkbox"/>	20	<ul style="list-style-type: none"> The Board may subject to the right of appeal conferred by section 58 decline to register the transfer of a share not being a fully paid share to a person of whom they do not approve or any transfer of



			shares on which the company has a lien.
<input type="checkbox"/>	<input type="checkbox"/>	21	<ul style="list-style-type: none"> The Board may decline to recognise any instrument of transfer unless the instrument of transfer is in the form as prescribed in rules made under sub-section (1) of section 56b, the instrument of transfer is accompanied by the certificate of the shares to which it relates and such other evidence as the Board may reasonably require to show the right of the transferor to make the transfer and c. the instrument of transfer is in respect of only one class of shares.
<input type="checkbox"/>	<input type="checkbox"/>	22	<ul style="list-style-type: none"> On giving not less than seven days previous notice in accordance with section 91 and rules made thereunder the registration of transfers may be suspended at such times and for such periods as the Board may from time to time determine Provided that such registration shall not be suspended for more than thirty days at any one time or for more than forty-five days in the aggregate in any year.
			Transmission of shares
<input type="checkbox"/>	<input type="checkbox"/>	23	<ul style="list-style-type: none"> On the death of a member the survivor or survivors where the member was a joint holder and his nominee or nominees or legal representatives where he was a sole holder shall be the only persons recognised by the company as having any title to his interest in the shares Nothing in clause (i) shall release the estate of a deceased joint holder from any liability in respect of any share which had been jointly held by him with other persons.
<input type="checkbox"/>	<input type="checkbox"/>	24	<ul style="list-style-type: none"> Any person becoming entitled to a share in consequence of the death or insolvency of a member may upon such evidence being produced as may from time to time properly be required by the Board and subject as hereinafter provided elect either to be registered himself as holder of the share or to make such transfer of the share as the deceased or insolvent member could have made. The Board shall in either case have the same right to decline or suspend registration as it would have had if the deceased or insolvent member had transferred the share before his death or insolvency.
<input type="checkbox"/>	<input type="checkbox"/>	25	<ul style="list-style-type: none"> If the person so becoming entitled shall elect to be registered as holder of the share himself he shall deliver or send to the company a notice in writing signed by him stating that he so elects. If the person aforesaid shall elect to transfer the share he shall testify his election by executing a transfer of the share. All the limitations restrictions and provisions of these regulations relating to the right to transfer and the registration of transfers of shares shall be applicable to any such notice or transfer as aforesaid as if the death or insolvency of the member had not occurred and the notice or transfer were a transfer signed by that member.
<input type="checkbox"/>	<input type="checkbox"/>		<ul style="list-style-type: none"> A person becoming entitled to a share by reason of the death or insolvency of the holder shall be entitled to the same dividends and other advantages to which he would be entitled if he were the registered holder of the share except that he shall not before being registered as a member in respect of the share be entitled in

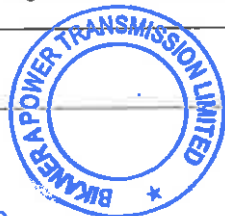

		26	respect of it to exercise any right conferred by membership in relation to meetings of the company Provided that the Board may at any time give notice requiring any such person to elect either to be registered himself or to transfer the share and if the notice is not complied with within ninety days the Board may thereafter withhold payment of all dividends bonuses or other monies payable in respect of the share until the requirements of the notice have been complied with.
<input checked="" type="checkbox"/>	<input type="checkbox"/>	27	<ul style="list-style-type: none"> In case of a One Person Company on the death of the sole member the person nominated by such member shall be the person recognised by the company as having title to all the shares of the member the nominee on becoming entitled to such shares in case of the members death shall be informed of such event by the Board of the company such nominee shall be entitled to the same dividends and other rights and liabilities to which such sole member of the company was entitled or liable on becoming member such nominee shall nominate any other person with the prior written consent of such person who shall in the event of the death of the member become the member of the company.
			Forfeiture of shares
<input type="checkbox"/>	<input type="checkbox"/>	28	<ul style="list-style-type: none"> If a member fails to pay any call or instalment of a call on the day appointed for payment thereof the Board may at any time thereafter during such time as any part of the call or instalment remains unpaid serve a notice on him requiring payment of so much of the call or instalment as is unpaid together with any interest which may have accrued.
<input type="checkbox"/>	<input type="checkbox"/>	29	<ul style="list-style-type: none"> The notice aforesaid shall name a further day (not being earlier than the expiry of fourteen days from the date of service of the notice) on or before which the payment required by the notice is to be made and state that in the event of non-payment on or before the day so named the shares in respect of which the call was made shall be liable to be forfeited.
<input type="checkbox"/>	<input type="checkbox"/>	30	<ul style="list-style-type: none"> If the requirements of any such notice as aforesaid are not complied with any share in respect of which the notice has been given may at any time thereafter before the payment required by the notice has been made be forfeited by a resolution of the Board to that effect.
<input type="checkbox"/>	<input type="checkbox"/>	31	<ul style="list-style-type: none"> A forfeited share may be sold or otherwise disposed of on such terms and in such manner as the Board thinks fit. At any time before a sale or disposal as aforesaid the Board may cancel the forfeiture on such terms as it thinks fit.
<input type="checkbox"/>	<input type="checkbox"/>	32	<ul style="list-style-type: none"> A person whose shares have been forfeited shall cease to be a member in respect of the forfeited shares but shall notwithstanding the forfeiture remain liable to pay to the company all monies which at the date of forfeiture were presently payable by him to the company in respect of the shares. The liability of such person shall cease if and when the company shall have received payment in full of all such monies in respect of the shares.
			<ul style="list-style-type: none"> A duly verified declaration in writing that the declarant is a director

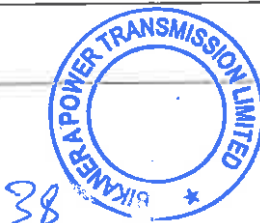

<input type="checkbox"/>	<input type="checkbox"/>	33	<p>the manager or the secretary of the company and that a share in the company has been duly forfeited on a date stated in the declaration shall be conclusive evidence of the facts therein stated as against all persons claiming to be entitled to the share The company may receive the consideration if any given for the share on any sale or disposal thereof and may execute a transfer of the share in favour of the person to whom the share is sold or disposed of The transferee shall thereupon be registered as the holder of the share and The transferee shall not be bound to see to the application of the purchase money if any nor shall his title to the share be affected by any irregularity or invalidity in the proceedings in reference to the forfeiture sale or disposal of the share.</p>
<input type="checkbox"/>	<input type="checkbox"/>	34	<ul style="list-style-type: none"> The provisions of these regulations as to forfeiture shall apply in the case of non-payment of any sum which by the terms of issue of a share becomes payable at a fixed time whether on account of the nominal value of the share or by way of premium as if the same had been payable by virtue of a call duly made and notified.
			<p>Alteration of capital</p>
<input type="checkbox"/>	<input type="checkbox"/>	35	<ul style="list-style-type: none"> The company may from time to time by ordinary resolution increase the share capital by such sum to be divided into shares of such amount as may be specified in the resolution.
<input type="checkbox"/>	<input type="checkbox"/>	36	<ul style="list-style-type: none"> Subject to the provisions of section 61 the company may by ordinary resolution consolidate and divide all or any of its share capital into shares of larger amount than its existing shares convert all or any of its fully paid-up shares into stock and reconvert that stock into fully paid-up shares of any denomination sub-divide its existing shares or any of them into shares of smaller amount than is fixed by the memorandum cancel any shares which at the date of the passing of the resolution have not been taken or agreed to be taken by any person.
<input type="checkbox"/>	<input type="checkbox"/>	37	<ul style="list-style-type: none"> Where shares are converted into stock the holders of stock may transfer the same or any part thereof in the same manner as and subject to the same regulations under which the shares from which the stock arose might before the conversion have been transferred or as near thereto as circumstances admit Provided that the Board may from time to time fix the minimum amount of stock transferable so however that such minimum shall not exceed the nominal amount of the shares from which the stock arose. the holders of stock shall according to the amount of stock held by them have the same rights privileges and advantages as regards dividends voting at meetings of the company and other matters as if they held the shares from which the stock arose but no such privilege or advantage (except participation in the dividends and profits of the company and in the assets on winding up) shall be conferred by an amount of stock which would not if existing in shares have conferred that privilege or advantage. such of the regulations of the company as are applicable to paid-up shares shall apply to stock and the words share and shareholder in those regulations shall include stock and stock-holder respectively.

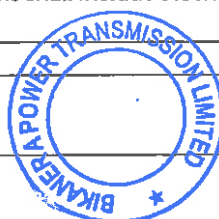

		38	<ul style="list-style-type: none"> The company may by special resolution reduce in any manner and with and subject to any incident authorised and consent required by law its share capital any capital redemption reserve account or any share premium account.
			Capitalisation of profits
		39	<ul style="list-style-type: none"> The company in general meeting may upon the recommendation of the Board resolve that it is desirable to capitalise any part of the amount for the time being standing to the credit of any of the company's reserve accounts or to the credit of the profit and loss account or otherwise available for distribution and that such sum be accordingly set free for distribution in the manner specified in clause (ii) amongst the members who would have been entitled thereto if distributed by way of dividend and in the same proportions. The sum aforesaid shall not be paid in cash but shall be applied subject to the provision contained in clause (iii) either in or towards paying up any amounts for the time being unpaid on any shares held by such members respectively paying up in full unissued shares of the company to be allotted and distributed credited as fully paid-up to and amongst such members in the proportions aforesaid partly in the way specified in sub-clause (A) and partly in that specified in sub-clause (B). A securities premium account and a capital redemption reserve account may for the purposes of this regulation be applied in the paying up of unissued shares to be issued to members of the company as fully paid bonus shares. The Board shall give effect to the resolution passed by the company in pursuance of this regulation.
		40	<ul style="list-style-type: none"> Whenever such a resolution as aforesaid shall have been passed the Board shall make all appropriations and applications of the undivided profits resolved to be capitalised thereby and all allotments and issues of fully paid shares if any and generally do all acts and things required to give effect thereto. The Board shall have power to make such provisions by the issue of fractional certificates or by payment in cash or otherwise as it thinks fit for the case of shares becoming distributable in fractions and to authorise any person to enter on behalf of all the members entitled thereto into an agreement with the company providing for the allotment to them respectively credited as fully paid-up of any further shares to which they may be entitled upon such capitalisation or as the case may require for the payment by the company on their behalf by the application thereto of their respective proportions of profits resolved to be capitalised of the amount or any part of the amounts remaining unpaid on their existing shares. Any agreement made under such authority shall be effective and binding on such members.
			Buy-back of shares
		41	<ul style="list-style-type: none"> Notwithstanding anything contained in these articles but subject to the provisions of sections 68 to 70 and any other applicable provision of the Act or any other law for the time being in force the company may purchase its own shares or other specified securities.

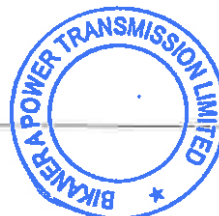

			General meetings
<input type="checkbox"/>	<input type="checkbox"/>	42	<ul style="list-style-type: none"> All general meetings other than annual general meeting shall be called extraordinary general meeting.
<input type="checkbox"/>	<input type="checkbox"/>	43	<ul style="list-style-type: none"> The Board may whenever it thinks fit call an extraordinary general meeting. If at any time directors capable of acting who are sufficient in number to form a quorum are not within India any director or any two members of the company may call an extraordinary general meeting in the same manner as nearly as possible as that in which such a meeting may be called by the Board.
			Proceedings at general meetings
<input type="checkbox"/>	<input type="checkbox"/>	44	<ul style="list-style-type: none"> No business shall be transacted at any general meeting unless a quorum of members is present at the time when the meeting proceeds to business. Save as otherwise provided herein the quorum for the general meetings shall be as provided in section 103.
<input type="checkbox"/>	<input type="checkbox"/>	45	<ul style="list-style-type: none"> The chairperson if any of the Board shall preside as Chairperson at every general meeting of the company.
<input type="checkbox"/>	<input type="checkbox"/>	46	<ul style="list-style-type: none"> If there is no such Chairperson or if he is not present within fifteen minutes after the time appointed for holding the meeting or is unwilling to act as chairperson of the meeting the directors present shall elect one of their members to be Chairperson of the meeting.
<input type="checkbox"/>	<input type="checkbox"/>	47	<ul style="list-style-type: none"> If at any meeting no director is willing to act as Chairperson or if no director is present within fifteen minutes after the time appointed for holding the meeting the members present shall choose one of their members to be Chairperson of the meeting.
<input checked="" type="checkbox"/>	<input type="checkbox"/>	48	<ul style="list-style-type: none"> In case of a One Person Company the resolution required to be passed at the general meetings of the company shall be deemed to have been passed if the resolution is agreed upon by the sole member and communicated to the company and entered in the minutes book maintained under section 118 such minutes book shall be signed and dated by the member the resolution shall become effective from the date of signing such minutes by the sole member.
			Adjournment of meeting
<input type="checkbox"/>	<input type="checkbox"/>	49	<ul style="list-style-type: none"> The Chairperson may with the consent of any meeting at which a quorum is present and shall if so directed by the meeting adjourn the meeting from time to time and from place to place. No business shall be transacted at any adjourned meeting other than the business left unfinished at the meeting from which the adjournment took place. When a meeting is adjourned for thirty days or more notice of the adjourned meeting shall be given as in the case of an original meeting. Save as aforesaid and as provided in section 103 of the Act it shall not be necessary to give any notice of an adjournment or of the business to be transacted at an

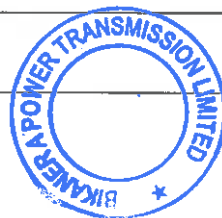

adjourned meeting.

Voting rights

- Subject to any rights or restrictions for the time being attached to any class or classes of shares on a show of hands every member present in person shall have one vote and on a poll the voting rights of members shall be in proportion to his share in the paid-up equity share capital of the company.

- A member may exercise his vote at a meeting by electronic means in accordance with section 108 and shall vote only once.

- In the case of joint holders the vote of the senior who tenders a vote whether in person or by proxy shall be accepted to the exclusion of the votes of the other joint holders. For this purpose seniority shall be determined by the order in which the names stand in the register of members.

- A member of unsound mind or in respect of whom an order has been made by any court having jurisdiction in lunacy may vote whether on a show of hands or on a poll by his committee or other legal guardian and any such committee or guardian may on a poll vote by proxy.

- Any business other than that upon which a poll has been demanded may be proceeded with pending the taking of the poll.

- No member shall be entitled to vote at any general meeting unless all calls or other sums presently payable by him in respect of shares in the company have been paid

- No objection shall be raised to the qualification of any voter except at the meeting or adjourned meeting at which the vote objected to is given or tendered and every vote not disallowed at such meeting shall be valid for all purposes. Any such objection made in due time shall be referred to the Chairperson of the meeting whose decision shall be final and conclusive.

Proxy

- The instrument appointing a proxy and the power-of-attorney or other authority if any under which it is signed or a notarised copy of that power or authority shall be deposited at the registered office of the company not less than 48 hours before the time for holding the meeting or adjourned meeting at which the person named in the instrument proposes to vote or in the case of a poll not less than 24 hours before the time appointed for the taking of the poll and in default the instrument of proxy shall not be treated as valid.

- An instrument appointing a proxy shall be in the form as prescribed in the rules made under section 105

- A vote given in accordance with the terms of an instrument of proxy shall be valid notwithstanding the previous death or insanity



	59	of the principal or the revocation of the proxy or of the authority under which the proxy was executed or the transfer of the shares in respect of which the proxy is given Provided that no intimation in writing of such death insanity revocation or transfer shall have been received by the company at its office before the commencement of the meeting or adjourned meeting at which the proxy is used.
		Board of Directors
✓	✓	<ul style="list-style-type: none"> The day to day management of the business of the Company shall be vested with the Board of Directors of the Company or such persons as may be authorized by the Board from time to time. The Board may exercise all such powers of the Company and do all such acts, deeds and things as are not prohibited by the Act or any other law for the time being in force or by the Memorandum of Association of a Company and without prejudice to the foregoing shall be responsible for all policy matters and the supervision, direction and control of the conduct of the business affairs and operations of the Company. The first Directors of the Company shall be 1. KUNTALA VENU GOPAL 2. DEBASIS MITRA 3. ARVIND KUMAR II at every annual general meeting. One third of such of the directors for the time being as are liable to retire by rotation or if their number is neither three nor a multiple of Three then the number nearest to one third shall retire from office. The directors to retire by rotation at every annual general Meeting shall be those who have been longest in office since their last appointment but as between persons who became directors on the same day those who are to retire shall in default of and subject to any subject to any agreement among themselves be determined by lot at an annual general meeting at which a director retires as aforesaid the company may fill up the vacancy by appointing there to any director or some other person thereto. The Board of Directors of the Company shall consist of not less than but not more than Directors. The appointment of Directors including the Chairman, Managing Director, Whole time Director, Part time Director shall be done in the General Meetings in accordance with the provisions of the Companies Act and Rules made there under and shall be eligible for appointment. However till the Company is a Government Company REC Power Development and Consultancy Limited RECPDCL the holding company shall have the full powers to recommend, nominate the name of any Directors to be appointed on the Board of the Company. Further RECPDCL shall also have the power to remove any director from office at any time in its absolute discretion. RECPDCL shall also have the right to fill any vacancies in the office of director caused by removal, resignation, death or otherwise. Subject to provisions of the Act the Company may by passing its resolution in General Meeting increase or decrease the maximum number of Directors and may alter their qualification. Further the Company may subject to the provisions of the Act remove any Director before the expiration of his period of office and appoint another person in place of him. The Board may appoint any person to act as an alternate director for a Director during the latter's absence for a period of not less than three months from India and such appointment shall have effect and such appointee whilst he holds office as an alternate director shall be entitled to notice of meeting of the Board and to attend and vote thereat accordingly but he shall not require any qualification and shall ipso facto vacate office if and when the absent Director returns to India.
	60	



43

			Casualvacanciesamong Directors may be filled by the Board of Directors at their meeting andany person so appointed shall hold the office as per the provision of sectionof the Act Subject to the provisions ofSectionand other applicable provisions if any of the Act the Board shall have power atany time and from time to time to appoint a person as an Additional Directorbut so that the total number of Directors shall not at any time exceed themaximum number fixed by these Articles The Additional Director so appointedshall retirefromOffice at next annual General Meeting but shall be eligible for election by thecompany at that meeting as a Director
<input type="checkbox"/>	<input type="checkbox"/>	61	<ul style="list-style-type: none"> The remuneration of the directors shall in so far as it consists of a monthly payment be deemed to accrue from day-to-day. In addition to the remuneration payable to them in pursuance of the Act the directors may be paid all travelling hotel and other expenses properly incurred by them in attending and returning from meetings of the Board of Directors or any committee thereof or general meetings of the company or in connection with the business of the company.
<input type="checkbox"/>	<input type="checkbox"/>	62	<ul style="list-style-type: none"> The Board may pay all expenses Incurred in getting up and registering the company.
<input type="checkbox"/>	<input type="checkbox"/>	63	<ul style="list-style-type: none"> The company may exercise the powers conferred on it by section 88 with regard to the keeping of a foreign register and the Board may (subject to the provisions of that section) make and vary such regulations as it may think fit respecting the keeping of any such register.
<input type="checkbox"/>	<input type="checkbox"/>	64	<ul style="list-style-type: none"> All cheques promissory notes drafts hundis bills of exchange and other negotiable Instruments and all receipts for monies paid to the company shall be signed drawn accepted endorsed or otherwise executed as the case may be by such person and in such manner as the Board shall from time to time by resolution determine
<input type="checkbox"/>	<input type="checkbox"/>	65	<ul style="list-style-type: none"> Every director present at any meeting of the Board or of a committee thereof shall sign his name in a book to be kept for that purpose.
<input type="checkbox"/>	<input type="checkbox"/>	66	<ul style="list-style-type: none"> Subject to the provisions of section 149 the Board shall have power at any time and from time to time to appoint a person as an additional director provided the number of the directors and additional directors together shall not at any time exceed the maximum strength fixed for the Board by the articles. Such person shall hold office only up to the date of the next annual general meeting of the company but shall be eligible for appointment by the company as a director at that meeting subject to the provisions of the Act.
			Proceedings of the Board
<input type="checkbox"/>	<input type="checkbox"/>	67	<ul style="list-style-type: none"> The Board of Directors may meet for the conduct of business adjourn and otherwise regulate its meetings as it thinks fit. A director may and the manager or secretary on the requisition of a



			director shall at any time summon a meeting of the Board.
<input type="checkbox"/>	<input type="checkbox"/>	68	<ul style="list-style-type: none"> Save as otherwise expressly provided in the Act questions arising at any meeting of the Board shall be decided by a majority of votes. In case of an equality of votes the Chairperson of the Board if any shall have a second or casting vote.
<input type="checkbox"/>	<input type="checkbox"/>	69	<ul style="list-style-type: none"> The continuing directors may act notwithstanding any vacancy in the Board but if and so long as their number is reduced below the quorum fixed by the Act for a meeting of the Board the continuing directors or director may act for the purpose of increasing the number of directors to that fixed for the quorum or of summoning a general meeting of the company but for no other purpose.
<input type="checkbox"/>	<input type="checkbox"/>	70	<ul style="list-style-type: none"> The Board may elect a Chairperson of its meetings and determine the period for which he is to hold office. If no such Chairperson is elected or if at any meeting the Chairperson is not present within five minutes after the time appointed for holding the meeting the directors present may choose one of their number to be Chairperson of the meeting.
<input type="checkbox"/>	<input type="checkbox"/>	71	<ul style="list-style-type: none"> The Board may subject to the provisions of the Act delegate any of its powers to committees consisting of such member or members of its body as it thinks fit. Any committee so formed shall in the exercise of the powers so delegated conform to any regulations that may be imposed on it by the Board.
<input type="checkbox"/>	<input type="checkbox"/>	72	<ul style="list-style-type: none"> A committee may elect a Chairperson of its meetings. If no such Chairperson is elected or if at any meeting the Chairperson is not present within five minutes after the time appointed for holding the meeting the members present may choose one of their members to be Chairperson of the meeting.
<input type="checkbox"/>	<input type="checkbox"/>	73	<ul style="list-style-type: none"> A committee may meet and adjourn as it thinks fit. Questions arising at any meeting of a committee shall be determined by a majority of votes of the members present and in case of an equality of votes the Chairperson shall have a second or casting vote.
<input type="checkbox"/>	<input type="checkbox"/>	74	<ul style="list-style-type: none"> All acts done in any meeting of the Board or of a committee thereof or by any person acting as a director shall notwithstanding that it may be afterwards discovered that there was some defect in the appointment of any one or more of such directors or of any person acting as aforesaid or that they or any of them were disqualified be as valid as if every such director or such person had been duly appointed and was qualified to be a director.
<input type="checkbox"/>	<input type="checkbox"/>	75	<ul style="list-style-type: none"> Save as otherwise expressly provided in the Act a resolution in writing signed by all the members of the Board or of a committee thereof for the time being entitled to receive notice of a meeting of the Board or committee shall be valid and effective as if it had been passed at a meeting of the Board or committee duly convened and held.
<input checked="" type="checkbox"/>	<input type="checkbox"/>		<ul style="list-style-type: none"> In case of a One Person Company where the company is having only one director all the businesses to be transacted at the meeting of the Board shall be entered into minutes book maintained under



		76	section 118 such minutes book shall be signed and dated by the director the resolution shall become effective from the date of signing such minutes by the director.
			Chief Executive Officer, Manager, Company Secretary or Chief Financial Officer
<input type="checkbox"/>	<input type="checkbox"/>	77	<ul style="list-style-type: none"> Subject to the provisions of the Act A chief executive officer manager company secretary or chief financial officer may be appointed by the Board for such term at such remuneration and upon such conditions as it may think fit and any chief executive officer manager company secretary or chief financial officer so appointed may be removed by means of a resolution of the Board A director may be appointed as chief executive officer manager company secretary or chief financial officer
<input type="checkbox"/>	<input type="checkbox"/>		
<input type="checkbox"/>	<input type="checkbox"/>	78	<ul style="list-style-type: none"> A provision of the Act or these regulations requiring or authorising a thing to be done by or to a director and chief executive officer manager company secretary or chief financial officer shall not be satisfied by its being done by or to the same person acting both as director and as or in place of chief executive officer manager company secretary or chief financial officer.
<input type="checkbox"/>	<input type="checkbox"/>		
			The Seal
<input type="checkbox"/>	<input type="checkbox"/>	79	<ul style="list-style-type: none"> The Board shall provide for the safe custody of the seal. The seal of the company shall not be affixed to any instrument except by the authority of a resolution of the Board or of a committee of the Board authorised by it in that behalf and except in the presence of at least two directors and of the secretary or such other person as the Board may appoint for the purpose and those two directors and the secretary or other person aforesaid shall sign every instrument to which the seal of the company is so affixed in their presence.
<input type="checkbox"/>	<input type="checkbox"/>		
			Dividends and Reserve
<input type="checkbox"/>	<input type="checkbox"/>	80	<ul style="list-style-type: none"> The company in general meeting may declare dividends but no dividend shall exceed the amount recommended by the Board.
<input type="checkbox"/>	<input type="checkbox"/>	81	<ul style="list-style-type: none"> Subject to the provisions of section 123 the Board may from time to time pay to the members such interim dividends as appear to it to be justified by the profits of the company.
<input type="checkbox"/>	<input type="checkbox"/>		
<input type="checkbox"/>	<input type="checkbox"/>	82	<ul style="list-style-type: none"> The Board may before recommending any dividend set aside out of the profits of the company such sums as it thinks fit as a reserve or reserves which shall at the discretion of the Board be applicable for any purpose to which the profits of the company may be properly applied including provision for meeting contingencies or for equalizing dividends and pending such application may at the like discretion either be employed in the business of the company or be invested in such investments (other than shares of the company) as the Board may from time to time thinks fit. The Board may also carry forward any profits which it may consider necessary not to divide without setting them aside as a reserve
<input type="checkbox"/>	<input type="checkbox"/>		
			<ul style="list-style-type: none"> Subject to the rights of persons if any entitled to shares with special



46

			rights as to dividends all dividends shall be declared and paid according to the amounts paid or credited as paid on the shares in respect whereof the dividend is paid but if and so long as nothing is paid upon any of the shares in the company dividends may be declared and paid according to the amounts of the shares. No amount paid or credited as paid on a share in advance of calls shall be treated for the purposes of this regulation as paid on the share. All dividends shall be apportioned and paid proportionately to the amounts paid or credited as paid on the shares during any portion or portions of the period in respect of which the dividend is paid but if any share is issued on terms providing that it shall rank for dividend as from a particular date such share shall rank for dividend accordingly.
		83	
			<ul style="list-style-type: none"> The Board may deduct from any dividend payable to any member all sums of money if any presently payable by him to the company on account of calls or otherwise in relation to the shares of the company.
		84	
			<ul style="list-style-type: none"> Any dividend interest or other monies payable in cash in respect of shares may be paid by cheque or warrant sent through the post directed to the registered address of the holder or in the case of joint holders to the registered address of that one of the joint holders who is first named on the register of members or to such person and to such address as the holder or joint holders may in writing direct. Every such cheque or warrant shall be made payable to the order of the person to whom it is sent.
		85	
			<ul style="list-style-type: none"> Any one of two or more joint holders of a share may give effective receipts for any dividends bonuses or other monies payable in respect of such share.
		86	
			<ul style="list-style-type: none"> Notice of any dividend that may have been declared shall be given to the persons entitled to share therein in the manner mentioned in the Act.
		87	
			<ul style="list-style-type: none"> No dividend shall bear interest against the company.
		88	
			Accounts
			<ul style="list-style-type: none"> The Board shall from time to time determine whether and to what extent and at what times and places and under what conditions or regulations the accounts and books of the company or any of them shall be open to the inspection of members not being directors. No member (not being a director) shall have any right of inspecting any account or book or document of the company except as conferred by law or authorised by the Board or by the company in general meeting.
		89	
			Winding up
			<ul style="list-style-type: none"> Subject to the provisions of Chapter XX of the Act and rules made thereunder if the company shall be wound up the liquidator may with the sanction of a special resolution of the company and any







47

		90	other sanction required by the Act divide amongst the members in specie or kind the whole or any part of the assets of the company whether they shall consist of property of the same kind or not. For the purpose aforesaid the liquidator may set such value as he deems fair upon any property to be divided as aforesaid and may determine how such division shall be carried out as between the members or different classes of members. The liquidator may with the like sanction vest the whole or any part of such assets in trustees upon such trusts for the benefit of the contributories if he considers necessary but so that no member shall be compelled to accept any shares or other securities whereon there is any liability.
			<i>Indemnity</i>
☐	☐	91	<ul style="list-style-type: none"> Every officer of the company shall be indemnified out of the assets of the company against any liability incurred by him in defending any proceedings whether civil or criminal in which judgment is given in his favour or in which he is acquitted or in which relief is granted to him by the court or the Tribunal.
			<i>Others</i>
☐	☐	92	*

Subscriber Details

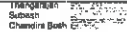
S. No.	Subscriber Details				
	*Name, Address, Description and Occupation	DIN / PAN / Passport number	*Place	DSC	Dated
1	REC POWER DEVELOPMENT AND CONSULTANCY LIMITED, CORE-4, SCOPE COMPLEX, 7, LODHI ROAD, NEW DELHI-110003, THROUGH ITS CEO RAJESH KUMAR S/O SHRINIWAS GUPTA R/O L-187, NAG MANDIR KE PAS SHASTRI NAGAR, ASHOK VIHAR, DELHI 110052, OCCUPATION-SERVICE	0*9*1*2*	NEW DELHI	RAJESH KUMAR	10/05/2024
2	PUTHIYARKATTU SHIVARAMAN HARIHARAN S/O SHRI PUTHIYARAKAT VELAYUDHAN SIVARAMAN NOMINEE OF REC POWER DEVELOPMENT AND CONSULTANCY LIMITED FLAT NO.104, SADAR APARTMENT, MAYUR VIHAR EXTENTION, PHASE-1, PLOT NO.9, NEW DELHI-110091, OCCUPATION-SERVICE	0*6*7*5*	NEW DELHI	P.S HARIHARAN	10/05/2024
3	ANIL KUMAR PERALA S/O VENKATESHAM NOMINEE OF REC POWER DEVELOPMENT AND CONSULTANCY LIMITED R/O A302 TARIKA APPARTMENT, SECTOR-43 GURGAON HARYANA-122001 OCCUPATION-SERVICE	B*V*P*1*2*	NEW DELHI	Perala Anil Kumar	10/05/2024



4	THANGARAJAN SUBASH CHANDIRA BOSH S/O SHRI SITHAN THANGARAJAN NOMINEE OF REC POWER DEVELOPMENT AND CONSULTANCY LIMITED R/O APARTMENT NO S-2, MIDDLE PORTION 2-B, JANGPURA, MATHURA ROAD, NEW DELHI-110014, OCCUPATION-SERVICE	0*7*2*1*	NEW DELHI		10/05/2024
5	SATYABAN SAHOO S/O MAHENDRA NATH SAHOO NOMINEE OF REC POWER DEVELOPMENT AND CONSULTANCY LIMITED R/O FLAT NO. B235 VASANT APPARTMENT GURGAON HARYANA-122001 OCCUPATION-SERVICE	A*K*S*0*9*	NEW DELHI		10/05/2024
6	ARVIND KUMAR S/O NAND KISHOR SINGH NOMINEE OF REC POWER DEVELOPMENT AND CONSULTANCY LIMITED R/O T4-8A, SAI VATIKA APARTMENT, SECTOR-63, FARIDABAD - 121004, OCCUPATION-SERVICE	1*3*2*3*	NEW DELHI		10/05/2024
7	MUKUL AGARWAL S/O SHRI RAJESH KUMAR NOMINEE OF REC POWER DEVELOPMENT AND CONSULTANCY LIMITED R/O HOUSE NO. 767, SECOND FLOOR, ANSAL C-2 BLOCK, NEAR WATER TANK ANSAL PLAZA, SECTOR-3 PALAM VIHAR, GURGAON-122017, HARYANA OCCUPATION-SERVICE	1*3*2*8*	NEW DELHI		10/05/2024

Signed before me

Name Prefix (ACA/FCA/ACS/ FCS/ACMA/ FCMA)	*Name of the witness	*Address, Description and Occupation	*DIN / PAN / Passport number / Membership		DSC	Dated
	VINAY KUMAR	A-805, NX BYTE T-3, NX ONE, TECH ZONE - IV, GREATER NOIDA WEST -201318	4*2*9*	NEW DELHI	 Digitally signed by Vinay Kumar Date: 2024.05.10 10:22:09 +05'30'	10/05/2024

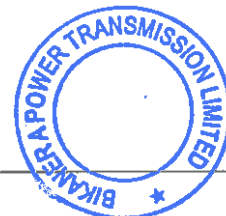

REC POWER DEVELOPMENT AND CONSULTANCY LIMITED
(A wholly owned subsidiary of REC Ltd.)

REQUEST FOR PROPOSAL (through e-bidding Only)
FOR ALLOCATION OF TRANSMISSION SERVICE THROUGH TBCB (TARIFF BASED BOOT) BASIS FOLLOWING SINGLE STAGE TWO ENVELOPE PROCESS OF "REQUEST FOR PROPOSAL (RFP)".
APPLICABLE FOR INTER - STATE TRANSMISSION PROJECTS

REC Power Development and Consultancy Limited, New Delhi, India (a wholly owned subsidiary of REC Limited, a Maharatna Central Public Sector Undertaking) invites proposal for setting up of the below mentioned transmission projects through TBCB process on Build, Own, Operate and Transfer (BOOT) basis following single stage two envelope process of "Request for Proposal (RFP)". Interested bidders may refer to the Request for Proposal (RFP) notifications and RFP documents available on our website www.recpdcl.in & www.recindia.nic.in w.e.f. 06.06.2024. The bidders may obtain the RFP documents on all working days between 1030 hours (IST) to 1800 hours (IST) from 06.06.2024 to one day prior to bid submission date on payment of non-refundable fee of Rs. 5,00,000/- (Rupees Five Lakh Only) or US\$ 7000 (US Dollars Seven Thousand Only) + 18% GST for each transmission project as per details provided in the RFP documents available on the website www.recpdcl.in & www.recindia.nic.in.

The Request for Proposal (RFP) documents can also be downloaded from our website www.recpdcl.in & www.recindia.nic.in, however, in such cases interested parties can submit Response to RFP only on submission of non-refundable fee of Rs. 5,00,000/- (Rupees Five Lakh Only) or US\$ 7000 (US Dollars Seven Thousand Only) + 18% GST for each transmission project as per details provided in the respective RFP document. The survey report & clarifications to RFP documents shall be issued to those bidders, who have obtained/purchased RFP document by paying requisite fee. The important timelines in this regard are as follows:

Sr. No.	Name of Project	Last Date for seeking clarifications	Last Date for submission of Response to RFP	Details of Opening of Response to RFP
1.	Transmission system for evacuation of power from Rajasthan REZ Ph-IV (Part-3: 6 GW) [Bikaner complex] :Part A	26.06.2024	09.08.2024 up to 1100 Hrs (IST)	09.08.2024 up to 1130 Hrs (IST)
2.	Transmission system for evacuation of power from Rajasthan REZ Ph-IV (Part-3: 6 GW) [Bikaner complex] :Part B	26.06.2024	09.08.2024 up to 1200 Hrs (IST)	09.08.2024 up to 1230 Hrs (IST)

All corrigenda, addenda, amendments, time extensions, etc. to the RFP will be hosted on our websites www.recpdcl.in & www.recindia.nic.in. Bidders should regularly visit our websites to keep themselves updated.
Note: RECPDCL reserves the right to cancel or modify the process without assigning any reason and without any liability. This is not an offer.

Chief Executive Officer
REC Power Development and Consultancy Ltd.
Core-4, SCOPE Complex, 7, Lodhi Road, New Delhi-110003, India

Bid Process Coordinator
REC Power Development
REC Power Development and Consultancy Limited

An Initiative of

Ministry of Power
Government of India

Initiative Partner

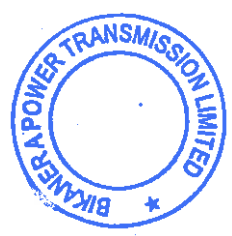
Central Electricity
Authority

(Handwritten Signature)



**STANDARD SINGLE STAGE REQUEST FOR
PROPOSAL DOCUMENT**

FOR

**SELECTION OF BIDDER AS TRANSMISSION
SERVICE PROVIDER THROUGH TARIFF BASED
COMPETITIVE BIDDING PROCESS**

TO

ESTABLISH INTER-STATE TRANSMISSION SYSTEM

FOR

**TRANSMISSION SYSTEM FOR EVACUATION OF
POWER FROM RAJASTHAN REZ PH-IV (PART-3:
6GW) [BIKANER COMPLEX]: Part-A**

ISSUED BY

**REC Power Development and Consultancy Limited
(A wholly owned subsidiary of REC Limited)**

**Registered Office:
Core-4, SCOPE Complex,
7, Lodhi Road, New Delhi – 110 003
Email: satyabhan.sahoo@recpdcl.in & tbc@recpdcl.in**

06.06.2024



[Handwritten signature]

ATTESTED TRUE COPY
Attested from pg 52 to pg 53

52

The Technical Bid shall be opened first and the Financial Bid of only the bidder who have qualified in the Technical Bid shall be opened. The Financial Bid will comprise of two rounds. In the first round the Initial Offer of the responsive bids would be opened and Quoted Transmission Charges of Initial Offer shall be ranked on the basis of ascending order. The Bidders, in the first fifty per cent of the ranking (with any fraction rounded off to higher integer) or four Bidders, whichever is higher, shall qualify for participating in the electronic reverse auction stage and submit their Final Offer.

6. The objective of the bidding process is to select a Successful Bidder pursuant to this RFP, who shall acquire one hundred percent (100%) of the equity shares of Bikaner A Power Transmission Limited along with all its related assets and liabilities as per the provisions of the Share Purchase Agreement, at the Acquisition Price to be intimated by the BPC, twenty (20) days prior to the Bid Deadline.

The Bikaner A Power Transmission Limited, of which one hundred percent (100%) equity shares will be acquired by the Selected Bidder, shall be responsible as the TSP, for ensuring that it undertakes ownership, financing, development, design, engineering, procurement, construction, commissioning, operation and maintenance of the Project, and to provide Transmission Service as per the terms of the RFP Project Documents.

The TSP shall ensure transfer of all project assets along with substation land, right of way and clearances to CTU or its successors or an agency as decided by the Central Government after 35 years from COD of project at zero cost and free from any encumbrance and liability. The transfer shall be completed within 90 days after 35 years from COD of project failing which CTU shall be entitled to take over the project assets Suo moto.

7. **Commencement of Transmission Service:** The Bidder shall have to commence Transmission Service in accordance with the provisions of the Transmission Service Agreement.
8. **Transmission Charges:** The Transmission Charges shall be payable by the Designated ISTS Customers in Indian Rupees through the CTU as per Central Electricity Regulatory Commission (Sharing of Inter-State Transmission Charges and Losses) Regulations as amended from time to time. Bidders shall quote the Transmission Charges as per the pre-specified structure, as mentioned in the RFP.
9. **Issue of RFP document:** The detailed terms and conditions for qualification and selection of the Transmission Service Provider for the Project and for submission of Bid are indicated in the RFP document. All those interested in purchasing the RFP document may respond in writing to Chief Executive Officer, satyabhan.sahoo@recpdcl.in & tcb@recpdcl.in at the address given in para 12 below with a non-refundable fee of Rs. 5,00,000/- (Rupees Five Lakh Only) or US\$ 7,000 (US Dollars Seven Thousand Only) plus GST @18%, to be paid latest by 08.08.2024 via electronic transfer to the following Bank Account:

Bank Name, Address & Branch	ICICI Bank 9A, Phelps Building, Inner Circle, Connaught Place, New Delhi 110001
Bank Account Name	REC Power Development & Consultancy Limited
Bank Account No	000705041275
Bank IFSC Code No	ICIC0000007

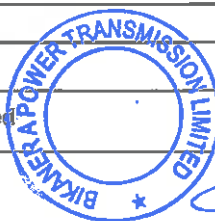

Date: 16.10.2024

CERTIFICATE BY BID EVALUATION COMMITTEE

Subject: Selection of Successful Bidder as Transmission Service Provider to establish "Transmission system for evacuation of power from Rajasthan REZ Ph-IV (Part-3: 6GW) [Bikaner complex]: Part-A" through tariff based competitive bidding process.

It is certified that:

- The entire bid process has been carried out in accordance with the "Tariff based Competitive Bidding Guidelines for Transmission Service" and "Guidelines for encouraging competition in development of the Transmission Projects" issued by Ministry of Power, Govt. of India under Section 63 of the Electricity Act, 2003 as amended from time to time.
- M/s Power Grid Corporation of India Limited, with the lowest annual transmission charges of Rs. 5,879.06 million, emerged as the successful Bidder after the conclusion of electronic reverse auction.
- The transmission charges of Rs. 5,879.06 million discovered after electronic reverse auction is acceptable.



(Rajesh Kumar Singh)
General Manager,
CCGRO II, SBI
Chairman, BEC



(Bhagwan Sahay Bairwa)
Chief Engineer (I/C)
(PSPA-II), CEA
Member, BEC

(Bhanwar Singh Meena)
Director (PSETD), CEA
Member, BEC

(D. K. Meena)
SE (Operations), NRPC
Member, BEC

(V. A. Kale)
SE, RVPN
Member, BEC

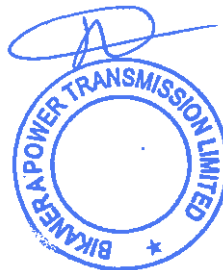
(Kuntala Venugopal)
Chairman - Bikaner A Power
Transmission Limited (SPV),
Convener - Member, BEC



REC Power Development and Consultancy Limited

(Formerly known as REC Power Distribution Company Limited.
A wholly owned subsidiary of REC Limited, a 'Maharatna CPSE'
under Ministry of Power, Govt. of India)



Ref No.: RECPDCL/TBCB/Raj Ph-IV Bikaner Part A/2024-25/ 2458

Date: 21.10.2024

To,
M/s Power Grid Corporation of India Limited
'Saudamini', Plot no. 2, Sector – 29,
Gurugram – 122001 (Haryana)

Kind Attention: Sh. Pankaj Pandey, ED

Subject: Establishment of "Transmission system for evacuation of power from Rajasthan REZ Ph-IV (Part-3: 6GW) [Bikaner complex]: Part-A" through Tariff Based Competitive Bidding Process (TBCB) – Letter of Intent.

Dear Sir,

We refer to:

1. The Request for Proposal (RfP) dated 06.06.2024 comprising RfP, Draft Transmission Service Agreement, Share Purchase Agreement and Survey Report dated 14.06.2024 issued to M/s Power Grid Corporation of India Limited, as regards participation in the Global Invitation for Bids for establishment of "Transmission system for evacuation of power from Rajasthan REZ Ph-IV (Part-3: 6GW) [Bikaner complex]: Part-A" through Tariff Based Competitive Bidding process including all correspondence/clarifications/amendments/errata/corrigendum issued by REC Power Development and Consultancy Limited in regard thereto (hereinafter collectively referred to as the 'Final RFP') till the submission of Bid Deadline and as listed below:
 - (i) Clarifications dated 22.07.2024
 - (ii) Amendment-I dated 08.08.2024,
 - (iii) Amendment-II dated 17.08.2024,
 - (iv) Amendment-III dated 28.08.2024,
 - (v) Amendment-IV and Additional Clarifications dated 04.09.2024,
 - (vi) Amendment-V dated 10.09.2024,
 - (vii) Amendment-VI dated 17.09.2024,
 - (viii) Amendment-VII and Additional Clarifications dated 21.09.2024,
2. The offer of M/s Power Grid Corporation of India Limited by way of a Technical Bid pursuant to (1) above submitted on 26.09.2024 in response to the Final RFP.
3. The Initial Price Offer of M/s Power Grid Corporation of India Limited as submitted on 26.09.2024 in response to the Final RFP.
4. The final offer of M/s Power Grid Corporation of India Limited, discovered during e-Reverse Auction, conducted on 08.10.2024 in response to the Final RFP.
5. The Technical Bid as in (2) above, the Initial Price Offer as in (3) above and the Final Offer as in (4) above hereinafter collectively referred to as the 'Bid'.

We are pleased to inform you that your proposal and offer received by way of the 'Bid' has been accepted and M/s Power Grid Corporation of India Limited is here by declared as Successful Bidder as per clause 3.6.1 of the Final RFP for the above project and consequently, this Letter of Intent (hereinafter referred to as the 'LoI') is being issued in 2 copies, One original plus One copy.

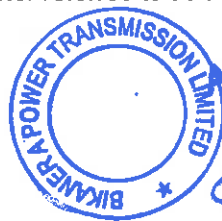

ATTESTED TRUE COPY
Attested from pg 55 to pg 61
Authorised Signatory
REC Power Development and Consultancy Limited
Gurugram
Page 1 of 4
Gurugram

This Lol is based on the Final RFP and is further contingent upon you satisfying the following conditions:

- (a) Acknowledging its issuance and unconditionally accepting its contents and recording 'Accepted unconditionally' under the signature and stamp of your authorized signatory on each page of the duplicate copy of this letter attached herewith and returning the same to REC Power Development and Consultancy Limited within 7 (Seven) days from the date of issuance of Lol.
- (b) Completion of various activities as stipulated in the RFP including in particular Clause 2.15.2, Clause 2.15.3 and Clause 2.15.4 of the Final RFP within the timelines as prescribed therein.
- (c) Provide the Contract Performance Guarantee of Rs. 157.50 Crore (Rupees One Hundred Fifty-Seven Crore Fifty Lakh Only) within 10 (Ten) days from issue of this Lol, in favour of the Central Transmission Utility of India Limited, as per the provisions of Clause 2.12.

It may be noted that REC Power Development and Consultancy Limited has the rights available to them under the Final RFP, including rights under clause 2.15.5 and 3.6.3 thereof, upon your failure to comply with the aforementioned conditions.

As you are aware, the issuance and contents of this Lol are based on the Bid submitted by you as per the Final RFP including the Transmission Charges and other details regarding the Scheduled COD as contained therein. The Quoted Transmission Charges as submitted by you and the Scheduled COD of transmission elements as agreed by you in your Bid, as per Annexure 21 and Format-1 of Annexure-8 respectively of the Final RFP is enclosed herewith as Schedule-A and incorporated herein by way of reference.

Further, please note that relationship of M/s Power Grid Corporation of India Limited with the REC Power Development and Consultancy Limited & Central Transmission Utility of India Limited will be governed solely on the basis of the Final RFP.

You are requested to unconditionally accept the Lol, and record on one copy of the Lol, 'Accepted unconditionally', under the signature of the authorized signatory of your Company and return such copy to us within 7 (Seven) days of issue of Lol.

Yours faithfully

Satish Sahasrabudhe
(Satish Sahasrabudhe)
General Manager (Tech) 21/10/24



Enclosures:

1. Schedule A: Quoted Transmission Charges and the scheduled COD of transmission element submitted in your Bid, as per Annexure 21 and Format-1 of Annexure-8 respectively of the Final RFP.



Copy for kind information to:

1. **The Secretary,**
Central Electricity Regulatory Commission,
6th Floor, Tower B, World Trade Centre,
Nauroji Nagar, New Delhi-110029.
2. **The Chairperson,**
Central Electricity Authority,
Sewa Bhawan, R K Puram,
New Delhi-110086.
3. **The Joint Secretary (Transmission),**
Ministry of Power,
Shram Shakti Bhawan,
Rafi Marg, New Delhi- 110 004.
4. **The Director (Transmission),**
Ministry of Power, Govt. of India,
Shram Shakti Bhawan, Raft Marg,
New Delhi 110001
5. **The Chief Engineer (PSP & PA -I)**
Central Electricity Authority,
Sewa Bhawan, R.K. Puram,
New Delhi – 110066.
6. **The Chief Operating Officer,**
Central Transmission Utility of India Limited,
5th to 10th Floor, Ircon International Tower,
Tower No.-1, Plot No. 16, Sector 32,
Gurugram, Haryana - 122003

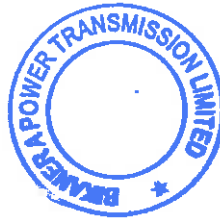

ANNEXURE 21 - FORMAT FOR FINANCIAL BID

Quoted Annual Transmission Charges: Rs. 5879.06 Million

Notes:

1. The Bidders are required to ensure compliance with the provisions of Clause 2.5.3 of this RFP.
2. Quotes to be in Rupees Millions and shall be up to two (2) decimal points.
3. The contents of this format shall be clearly typed.
4. The Financial Bid shall be digitally signed by the authorized signatory in whose name power of attorney as per Clause 2.5.2 is issued.
5. Ensure only one value for annual Transmission Charges is quoted. The same charge shall be payable every year to TSP for the term of TSA.





UNDERTAKING AND DETAILS OF EQUITY INVESTMENT

Format 1: Bidders' Undertakings

Date: 25/09/2024

To,
Chief Executive Officer,
REC Power Development and Consultancy Limited
(A wholly owned subsidiary of REC Limited)
REC Corporate Head Quarter,
D Block, Plot No. 1-4,
Sec - 29 Gurugram - 122 001
Dear Sir,

Sub: Bidders' Undertakings in respect of Bid for selection of Bidder as TSP to establish Inter-State Transmission system for "Transmission system for evacuation of power from Rajasthan REZ Ph-IV (Part-3: 6GW) [Bikaner complex]: Part A".

We hereby undertake on our own behalf and on behalf of the TSP, that if selected as the Successful Bidder for the Project:

1. The Project shall comply with all the relevant electricity laws, codes, regulations, standards and Prudent Utility Practices, environment laws and relevant technical, operational and safety standards, and we shall execute any agreements that may be required to be executed as per law in this regard.
2. We confirm that the Project shall also comply with the standards and codes as per Clause 1.6.1.2 of the RFP and the TSP shall comply with the provisions contained in the Central Electricity Regulatory Commission Grant of Connectivity, Long-term Access and Medium-term Open Access in inter-state Transmission and related matters Open Access) Regulations, 2009.
3. We give our unconditional acceptance to the RFP dated 06.06.2024 issued by the BPC and the RFP Project Documents, as amended, and undertake to ensure that the TSP shall execute all the RFP Project Documents, as per the provisions of this RFP.
4. We have submitted the Bid on the terms and conditions contained in the RFP and the RFP Project Documents. Further, the Financial Bid submitted by us is strictly as per the format provided in Annexure 21 of the RFP, without mentioning any deviations, conditions, assumptions or notes in the said Annexure.
5. Our Bid is valid up to the period required under Clause 2.8 of the RFP.
6. Our Bid has been duly signed by authorized signatory and stamped in the manner and to the extent indicated in this RFP and the power of attorney / Board resolution in requisite format as per RFP has been enclosed with this undertaking.

Kushor



केन्द्रीय कार्यालय : "सौदामिनी" प्लॉट सं. 2, सेक्टर-29, गुरुग्राम-122001 (हरियाणा), दिल्ली
Corporate Office : "Saudamini", Plot No. 2, Sector-29, Gurugram-122001, (Haryana) Tel: 011-26560112, 26564812
पञ्जीकृत कार्यालय : पी-8, कृतुब इंस्टीटयुशनल एरिया, कटवारिया सराय, नई दिल्ली-110016 011-26560112, 26564812
Regional Office : B-8, Qutab Institutional Area, Katwarie Sarai, New Delhi-110016. Tel: 011-26560112, 26564812
Website : www.powergrid.in

7. [NOT APPLICABLE].

8. We confirm that our Bid meets the Scheduled COD of each transmission Element and the Project as specified below:

Sl. No	Name of the Transmission Element	Scheduled COD	Percentage of Quoted Transmission Charges recoverable on Scheduled COD of the Element of the Project	Element(s) which are pre-required for declaring the commercial operation (COD) of the respective Element
1.	Establishment of 6x1500 MVA, 765/400 kV and 6x500 MVA, 400/220 kV Bikaner-IV Pooling Station along with 2x240 MVar (765 kV) and 2x125 MVar (420kV) Bus Reactors at a suitable location near Bikaner	24 months from SPV transfer	100%	All Elements are required to be commissioned simultaneously as their utilization is dependent on each other.
2.	STATCOM (2x300 MVar) along with MSC (4x125 MVar) and MSR (2x125 MVar) at Bikaner-IV PS			
3.	LILO of both ckts of Bikaner II PS- Bikaner III PS (Quad) direct 400 kV line at Bikaner-IV PS			
4.	Bikaner-IV PS – Siwani 765 kV D/C line along with 240 MVar switchable line reactor for each circuit at each end			
5.	Siwani– Fatehabad (PG) 400 kV D/C line (Quad)			
6.	Siwani – Patran (Indi Grid) 400 kV D/C line (Quad) along with 80 MVar switchable line reactor for each circuit at Siwani S/s end			
7.	2 Nos. 400 kV line bays each at Fatehabad (PG) and Patran (Indi Grid) GIS S/s			
8.	2 Nos. 765 kV line bays at Siwani S/s			
9.	4 Nos. 400 kV line bays at Siwani S/s			

Note:

- POWERGRID shall provide space for 2 Nos. of 400 kV line bays at Fatehabad (PG).IndiGrid shall provide space for 2 Nos. of 400 kV line bays (GIS) at Patran (Indi Grid) S/s.
- Developer of Siwani S/s shall provide space for 2 Nos. of 765 kV line bays and 4 Nos. of 400 kV line bays at Siwani S/s.

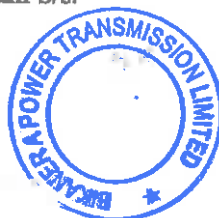

के.एस. केशव / K. S. Keshav
 ज. म. अधिकारी / Dy. General Manager (1988)
 पावर ग्रिड कॉर्पोरेशन ऑफ इंडिया लिमिटेड
 Power Grid Corporation of India Ltd.
 (भारत सरकार का उद्यम) / (A Govt. of India Enterprise)
 प्लॉट नं-2, सेक्टर-29, गुरुगंज-122 001 (हरियाणा)
 Plot No.-2, Sector-29, Gurgaon-122 001 (Haryana)

Keyshor

We agree that the payment of Transmission Charges for any Element irrespective of its successful commissioning on or before its Scheduled COD shall only be considered after the successful commissioning of Element(s) which are pre - required for declaring the commercial operation of such Element as mentioned in the above table.

Scheduled COD for the Project: 24 months from the date of SPV Transfer.

9. We confirm that our Financial Bid conforms to all the conditions mentioned in this RFP, and in particular, we confirm that:
- a. Financial Bid in the prescribed format of Annexure 21 has been submitted duly signed by the authorized signatory.
 - b. Financial Bid is unconditional.
 - c. Only one Financial Bid has been submitted.
10. We have neither made any statement nor provided any information in this Bid, which to the best of our knowledge is materially inaccurate or misleading. Further, all the confirmations, declarations and representations made in our Bid are true and accurate. In case this is found to be incorrect after our acquisition of **Bikaner A Power Transmission Limited**, pursuant to our selection as Selected Bidder, we agree that the same would be treated as a TSP's Event of Default under Transmission Service Agreement, and relevant provisions of Transmission Service Agreement shall apply.
11. We confirm that there are no litigations or other disputes against us which materially affect our ability to fulfill our obligations with regard to the Project as per the terms of RFP Project Documents.
12. Power of attorney/ Board resolution as per Clause 2.5.2 is enclosed.

.....
Kaushal

(Signature)

Name: *Kaushal Kishor*
Designation: *Deputy General Manager*

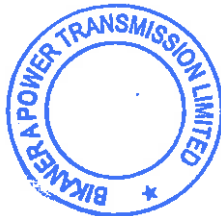

58

कौशल किशोर / KAUSHAL KISHOR
उप महासंचालक (टी.बी.सी.बी.) / Dy. General Manager (TBCB)
पावर ग्रिड कॉर्पोरेशन ऑफ इंडिया लिमिटेड
Power Grid Corporation of India Ltd.
(भारत सरकार का उद्यम) / (A Govt. of India Enterprise)
प्लॉट नं०-2, सेक्टर-29, गुडगांव-122 001 (हरियाणा)
Plot No.-2, Sector-29, Gurgaon- 122 001 (Haryana)

**STANDARD SINGLE STAGE REQUEST FOR
PROPOSAL DOCUMENT**

FOR

**SELECTION OF BIDDER AS TRANSMISSION
SERVICE PROVIDER THROUGH TARIFF BASED
COMPETITIVE BIDDING PROCESS**

TO

ESTABLISH INTER-STATE TRANSMISSION SYSTEM

FOR

**TRANSMISSION SYSTEM FOR EVACUATION OF
POWER FROM RAJASTHAN REZ PH-IV (PART-3:
6GW) [BIKANER COMPLEX]: Part-A**

ISSUED BY

**REC Power Development and Consultancy Limited
(A wholly owned subsidiary of REC Limited)**

**Registered Office:
Core-4, SCOPE Complex,
7, Lodhi Road, New Delhi – 110 003
Email: satyabhan.sahoo@recpdcl.in & tcb@recpdcl.in**

06.06.2024

ATTESTED TRUE COPY:
Attested from pg 62 to pg 65

Authorised Signatory

BIKANER A POWER TRANSMISSION LIMITED

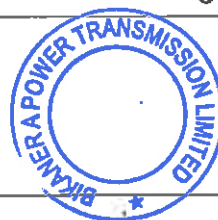

2.15 Other Aspects

2.15.1. The draft of the Transmission Service Agreement has been attached to this RFP. In addition to above, the following documents have also been attached to this RFP:

a) Share Purchase Agreement

When the drafts of the above RFP Project Documents are provided by the BPC, these RFP Project Documents shall form part of this RFP as per Formats – 1 & 2 of Annexure 20.

Upon finalization of the RFP Project Documents after incorporating the amendments envisaged in Clause 2.4 of this RFP, all the finalized RFP Project Documents shall be provided by BPC to the Bidders at least fifteen (15) days prior to the Bid Deadline.

The Transmission Service Agreement and Share Purchase Agreement shall be signed in required number of originals so as to ensure that one (1) original is retained by each party to the Agreement(s) on the date of transfer of SPV.

2.15.2. Within ten (10) days of the issue of the Letter of Intent, the Selected Bidder shall:

- a) provide the Contract Performance Guarantee in favour of the Nodal Agency as per the provisions of Clause 2.12;
- b) execute the Share Purchase Agreement and the Transmission Service Agreement;
- c) acquire, for the Acquisition Price, one hundred percent (100%) equity shareholding of Bikaner A Power Transmission Limited from REC Power Development and Consultancy Limited, who shall sell to the Selected Bidder, the equity shareholding of Bikaner A Power Transmission Limited, along with all its related assets and liabilities;

Stamp duties payable on purchase of one hundred percent (100%) of the equity shareholding of Bikaner A Power Transmission Limited, along with all its related assets and liabilities, shall also be borne by the Selected Bidder.

Provided further that, if for any reason attributable to the BPC, the above activities are not completed by the Selected Bidder within the above period of ten (10) days as mentioned in this Clause, such period of ten (10) days shall be extended, on a day for day basis till the end of the Bid validity period.

2.15.3. After the date of acquisition of the equity shareholding of Bikaner A Power Transmission Limited, along with all its related assets and liabilities, by the Selected Bidder,

- i. the authority of the BPC in respect of this Bid Process shall forthwith cease and any actions to be taken thereafter will be undertaken by the Nodal Agency,
- ii. all rights and obligations of Bikaner A Power Transmission Limited, shall be of the TSP,

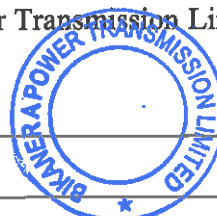

- iii. any decisions taken by the BPC prior to the Effective Date shall continue to be binding on the Nodal Agency and
 - iv. contractual obligations undertaken by the BPC shall continue to be fulfilled by the TSP.
 - v. Further, the TSP shall execute the Agreement(s) required, if any, under Central Electricity Regulatory Commission (Sharing of Inter-State Transmission Charges and Losses) Regulations as amended from time to time.
- 2.15.4. Within five (5) working days of the issue of the acquisition of the SPV by the Successful Bidder, the TSP shall apply to the Commission for grant of Transmission License and make an application to the Commission for the adoption of Transmission Charges, as required under Section – 63 of The Electricity Act 2003.
- 2.15.5. If the Selected Bidder / TSP fails or refuses to comply with any of its obligations under Clauses 2.15.2, 2.15.3 and 2.15.4, and provided that the other parties are willing to execute the Share Purchase Agreement and REC Power Development and Consultancy Limited is willing to sell the entire equity shareholding of **Bikaner A Power Transmission Limited**, along with all its related assets and liabilities, to the Selected Bidder, such failure or refusal on the part of the Selected Bidder shall constitute sufficient grounds for cancellation of the Letter of Intent. In such cases, the BPC / its authorized representative(s) shall be entitled to invoke the Bid Bond of the Selected Bidder.
- 2.15.6. If the TSP fails to obtain the Transmission License from the Commission, it will constitute sufficient grounds for annulment of award of the Project.
- 2.15.7. The annulment of award, as provided in Clauses 2.15.5 and 2.15.6 of this RFP, will be done by the Government on the recommendations of National Committee on Transmission. However, before recommending so, National Committee on Transmission will give an opportunity to the Selected Bidder / TSP to present their view point.
- 2.15.8. The annulment of the award, under Clause 2.15.5 or 2.15.6 of this RFP, shall be sufficient grounds for blacklisting the bidder, whose award has been annulled, for a period of five years or more, as decided by the National Committee on Transmission, provided that the blacklisting shall be done only after giving the bidder an opportunity for showing cause.

2.16 Confidentiality

- 2.16.1. The parties undertake to hold in confidence this RFP and RFP Project Documents and not to disclose the terms and conditions of the transaction contemplated hereby to third parties, except:
- a) to their professional advisors;
 - b) to their officers, contractors, employees, agents or representatives, financiers, who need to have access to such information for the proper performance of their activities;
 - c) disclosures required under Law, without the prior written consent of the other parties of the concerned agreements.

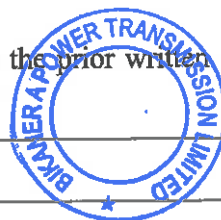

Ref No RECPDCL/TBCB/Raj Ph-IV Bikaner Part-A/2024-25/2458

Date: 11.11.2024

Sh. Pankaj Pandey, ED,
M/s Power Grid Corporation of India Limited
'Saudamini', Plot no. 2, Sector – 29,
Gurugram – 122001 (Haryana)

Sub: Establishment of Transmission System for "Transmission system for evacuation of power from Rajasthan REZ Ph-IV (Part-3: 6GW) [Bikaner complex]: Part-A" through tariff based competitive bidding process – Extension of Lol-regarding.

Ref.: RECPDCL/TBCB/Raj Ph-IV Bikaner Part-A/2024-25/2458, Dated 21.10.2024

Dear Sir,

This is in reference to above referred Letter of Intent dated 21st October, 2024 issued to M/s Power Grid Corporation of India Limited for **Transmission system for evacuation of power from Rajasthan REZ Ph-IV (Part-3: 6GW) [Bikaner complex]: Part-A.**

To complete the activities mentioned under Clause 2.15.2, Clause no. 2.15.3 and Clause no. 2.15.4 of Request for Proposal (RFP) document, the last date for completion of various activities, is extended till 19th November, 2024.

Thanking You.

Yours faithfully,

Satyaban Sahoo
(Satyaban Sahoo) 11/11/24
General Manager (Tech)

[Handwritten signature]

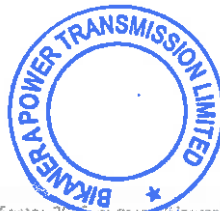

TRANSMISSION SERVICE AGREEMENT

FOR

**DEVELOPMENT AND OPERATION OF
INTER-STATE TRANSMISSION SYSTEM**

**FOR TRANSMISSION OF ELECTRICITY
THROUGH TARIFF BASED
COMPETITIVE BIDDING FOR**

**TRANSMISSION SYSTEM FOR
EVACUATION OF POWER FROM
RAJASTHAN REZ PH-IV (PART-3: 6GW)
[BIKANER COMPLEX]:PART-A
BETWEEN THE**

**CENTRAL TRANSMISSION UTILITY OF
INDIA LIMITED
(NODAL AGENCY)**

AND

**BIKANER A POWER TRANSMISSION
LIMITED**

November...!!th....., 2024

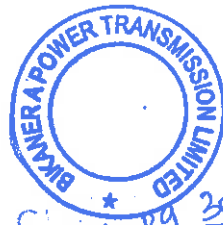

ATTESTED TRUE
Attested from Pg 66 to Pg 301

Authorised Sign
BIKANER A POWER TRANSMISSION LIMITED

66

CONTENTS

1	Definitions and Interpretations	6
2	Effectiveness and Term of Agreement	18
3	Conditions Subsequent	20
4	Development of the Project	24
5	Construction of the Project	28
6	Connection and commissioning of the Project	33
7	Operation and Maintenance of the Project	38
8	Availability of the project	39
9	Insurances	40
10	Billing And Payment of Transmission Charges	42
11	Force Majeure	43
12	Change in Law	48
13	Events of Default and Termination.....	51
14	Liability and Indemnification	56
15	Assignments and Charges	61
16	Governing Law and Dispute Resolution.....	63
17	Representation and Warranties	65
18	Independent Engineer	67
19	Miscellaneous Provisions	69

Central Transmission Utility of India Limited

2

Bikaner A Power Transmission

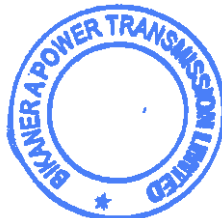

AD



Book



Indian-Non Judicial Stamp
Haryana Government



Date : 21/10/2024

Certificate No. GOU2024J4441



Stamp Duty Paid ₹ 101

GRN No. 122791824

Penalty : ₹ 0

(Rs. Zero Only)

Deponent

Name: Central Transmission utility of India ltd

H.No/Floor : 2

Sector/Ward : 29

Landmark : Na

City/Village : Gurugram

District : Gurugram

State : Haryana

Phone : 98*****10



Purpose : ARTICLE 5 GENERAL AGREEMENT to be submitted at Concerned office

THIS TRANSMISISON SERVICE AGREEMENT (hereinafter referred to as "TSA" or "Agreement" or "the Agreement" or "this Agreement") is made on the/11/..... [Insert day] of ~~November~~ [Insert month] of Two Thousand and 2024

BETWEEN:

The Central Transmission Utility of India Limited, having its registered address at "Saudamini",1st Floor, Plot No. 2, Sector-29, Gurugram-122001, Haryana and correspondence address at 5th to10th Floor, Ircon International Tower, Tower no-1, Plot no -16 , Sector-32, Gurugram, Haryana-122003, acting as a Nodal Agency (referred to as the "Nodal Agency"), which expression shall unless repugnant to the context or meaning thereof include its successors, and permitted assigns) as Party of the one part;

AND

Bikaner A Power Transmission Limited incorporated under the Companies Act, 2013, having its registered office at Core-4, Scope Complex 7, Lodhi Road Delhi, South Delhi, Delhi 110003 (herein after referred to as "Transmission Service Provider" or "TSP" or "ISTS Licensee", which expression shall unless repugnant to the context or meaning thereof include its successors, and permitted assigns) as Party of the other part;

("Nodal Agency" and "TSP" are individually referred to as "Party" and collectively as the "Parties"

Central Transmission Utility of India Limited

3

Bikaner A Power Transmission Limited

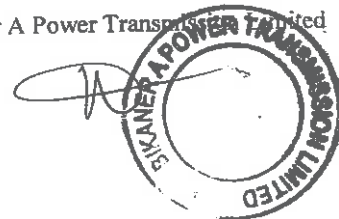
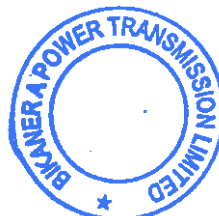
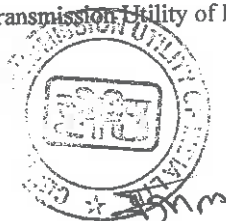

AND WHEREAS:

- A) In accordance with the Bidding Guidelines, the Bid Process Coordinator (hereinafter referred to as BPC) had initiated a competitive e-reverse bidding process through issue of RFP for selecting a Successful Bidder to build, own, operate and transfer the Project comprising of the Elements mentioned in Schedule 1 (hereinafter referred to as the Project)
- B) Pursuant to the said e-reverse bidding process, the BPC has identified the Successful Bidder, who will be responsible to set up the Project on build, own, operate and transfer basis to provide Transmission Service in accordance with the terms of this Agreement and the Transmission License.
- C) The Selected Bidder have submitted the Contract Performance Guarantee and acquired one hundred percent (100%) of the equity shareholding Bikaner A Power Transmission Limited, along with all its related assets and liabilities in terms of the provisions of the Share Purchase Agreement.
- D) The TSP has agreed to make an application for a Transmission License to the Commission for setting up the Project on build, own, operate and transfer basis.
- E) The TSP has further agreed to make an application to the Commission for the adoption of the Transmission Charges under Section 63 of the Electricity Act, 2003, along with a certification from the Bid Evaluation Committee in accordance with the Bidding Guidelines issued by Ministry of Power, Government of India.
- F) The TSP has agreed to execute the agreement(s) required, if any, under Sharing Regulations within fifteen (15) days from the date of grant of Transmission License from the Commission.
- G) The TSP agrees to the terms and conditions laid down under Sharing Regulations, for making available the ISTS and charge the Transmission Charges in accordance with the terms and conditions of Sharing Regulations.
- H) The billing, collection and disbursement of the Transmission Charges by the CTU to the ISTS Licensee shall be governed as per Sharing Regulations.
- I) The terms and conditions stipulated in the Transmission License issued by the Commission to the TSP shall be applicable to this Agreement and the TSP agrees to comply with these terms and conditions. In case of inconsistency between the Transmission License terms & conditions and the conditions of this Agreement, the conditions stipulated in the Transmission License granted by the Commission shall prevail.

Central Transmission Utility of India Limited

4

Bikaner A Power Transmission Limited

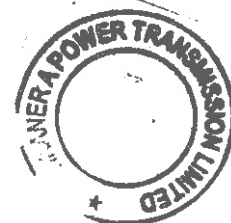
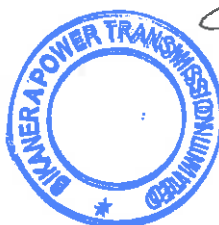
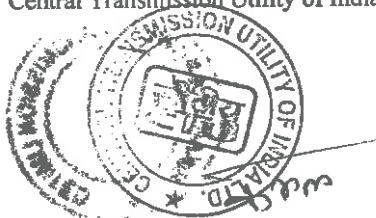

NOW, THEREFORE, IN CONSIDERATION OF THE PREMISES AND MUTUAL AGREEMENTS, COVENANTS AND CONDITIONS SET FORTH HEREIN, IT IS HEREBY AGREED BY AND BETWEEN THE PARTIES HERETO AS FOLLOWS:

Central Transmission Utility of India Limited

5

Bikaner A Power Transmission Limited

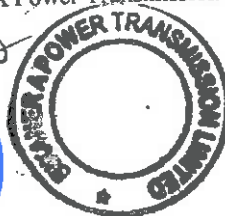
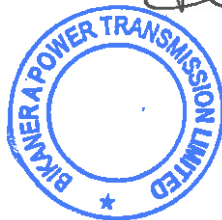

ARTICLE: 1

1 DEFINITIONS AND INTERPRETATIONS

1.1 Definitions:

1.1.1 The words / expressions used in this Agreement, unless as defined below or repugnant to the context, shall have the same meaning as assigned to them by the Electricity Act, 2003 and the rules or regulations framed there under including those issued / framed by the Commission (as defined hereunder), as amended or re-enacted from time to time or the General Clauses Act, failing which it shall bear its ordinary English meaning.

The words/expressions when used in this Agreement shall have the respective meanings as specified below:

“Acquisition Price” shall have the same meaning as defined in the Share Purchase Agreement;

“Act” or “Electricity Act” or “Electricity Act 2003” shall mean the Electricity Act, 2003 and any amendments made to the same or any succeeding enactment thereof;

“Affiliate” shall mean a company that either directly or indirectly

- i. controls or
- ii. is controlled by or
- iii. is under common control with

a Bidding Company (in the case of a single company) or a Member (in the case of a Consortium) and “control” means ownership by one entity of at least twenty-six percent (26%) of the voting rights of the other entity;

“Availability” in relation to the Project or in relation to any Element of the Project, for a given period shall mean the time in hours during that period the Project is capable to transmit electricity at its Rated Voltage and shall be expressed in percentage of total hours in the given period and shall be calculated as per the procedure contained in Appendix –IV to Central Electricity Regulatory Commission (Terms and Conditions of Tariff) Regulations, 2024, attached herewith in Schedule 6;

“Bid” shall mean technical bid and financial bid submitted by the Bidder, in response to the RFP, in accordance with the terms and conditions of the RFP;

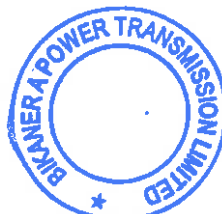
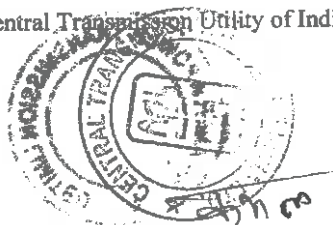

A

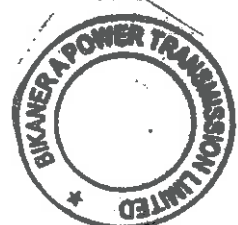

71

“**Bid Deadline**” shall mean the last date and time for submission of the Bid in response to RFP, as specified in the RFP;

“**Bidding Company**” shall refer to such single company that has made a Response to RFP for the Project;

“**Bidding Consortium / Consortium**” shall refer to a group of companies that has collectively made a Response to RFP for the Project;

“**Bid Documents**” or “**Bidding Documents**” shall mean the RFP, along with all attachments thereto or clarifications thereof;

“**Bidding Guidelines**” shall mean the “Tariff Based Competitive Bidding Guidelines for Transmission Service” and “Guidelines for Encouraging Competition in Development of Transmission Projects” issued by Government of India, Ministry of Power under Section – 63 of the Electricity Act as amended from time to time;

“**Bid Process Coordinator**” or “**BPC**” shall mean a person or its authorized representative as notified by the Government of India, responsible for carrying out the process for selection of Bidder who will acquire Transmission Service Provider;

“**Bill**” shall mean any bill raised by the CTU on the DICs to recover the Transmission Charges pursuant to the Sharing Regulations;

“**Business Day**” shall mean a day other than Sunday or a statutory holiday, on which the banks remain open for business in the State in which the Nodal Agency’s registered office is located and the concerned TSP are located;

“**CEA**” shall mean the Central Electricity Authority constituted under Section -70 of the Electricity Act;

“**Change in law**” shall have the meaning ascribed thereto in Article 12;

“**Commercial Operation Date**” or “**COD**” shall mean the date as per Article 6.2;

“**Commission**” or “**CERC**” shall mean the Central Electricity Regulatory Commission referred to in sub-section (1) of Section 76 of the Electricity Act, 2003 or its successors and assigns;

“**Competent Court of Law**” shall mean the Supreme Court or any High Court, or any tribunal or any similar judicial or quasi-judicial body in India that has jurisdiction to adjudicate upon issues relating to the Project;

Central Transmission Utility of India Limited

Bikaner A Power Transmission Limited

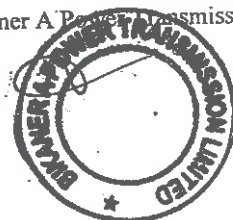
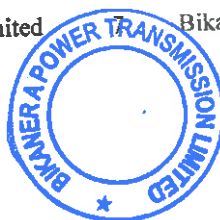
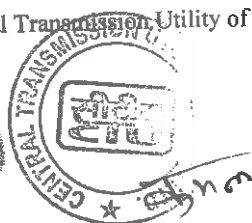
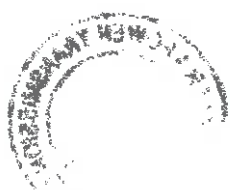

“**Connection Agreement**” shall mean the agreement between the CTU or STU or any other concerned parties and the TSP, setting out the terms relating to the connection of the Project to the Inter-connection Facilities and use of the Inter State Transmission System as per the provisions of the IEGC, as the case may be;

“**Consultation Period**” shall mean the period of sixty (60) days or such longer period as the Parties may agree, commencing from the date of issue of a TSP’s Preliminary Notice or a Nodal Agency’s Preliminary Termination Notice, as provided in Article 13 of this Agreement, for consultation between the Parties to mitigate the consequence of the relevant event having regard to all the circumstances;

“**Consents, Clearances and Permits**” shall mean all authorizations, licenses, approvals, registrations, permits, waivers, privileges, acknowledgements, agreements, or concessions required to be obtained from or provided by any concerned authority for the development, execution and operation of Project including without any limitation for the construction, ownership, operation and maintenance of the Transmission Lines and/or sub-stations;

“**Construction Period**” shall mean the period from (and including) the Effective Date of the Transmission Service Agreement up to (but not including) the COD of the Element of the Project in relation to an Element and up to (but not including) the COD of the Project in relation to the Project;

“**Contractors**” shall mean the engineering, procurement, construction, operation & maintenance contractors, surveyors, advisors, consultants, designers, suppliers to the TSP and each of their respective sub-contractors (and each of their respective successors and permitted assigns) in their respective capacities as such;

“**Contract Performance Guarantee**” shall mean the irrevocable unconditional bank guarantee, submitted and to be submitted by the TSP or by the Selected Bidder on behalf of the TSP to the Nodal Agency from a bank mentioned in Annexure 17 of the RFP, in the form attached here to as Schedule 8, in accordance with Article 3 of this Agreement and which shall include the additional bank guarantee furnished by the TSP under this Agreement;

“**Contract Year**”, for the purpose of payment of Transmission Charges, shall mean the period beginning on the COD, and ending on the immediately succeeding March 31 and thereafter each period of 12 months beginning on April 1 and ending on March 31 provided that the last Contract Year shall end on the last day of the term of the TSA;

“**CTU**” or “**Central Transmission Utility**” shall have same meaning as defined in the Electricity Act, 2003;

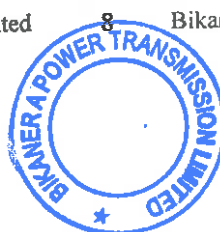
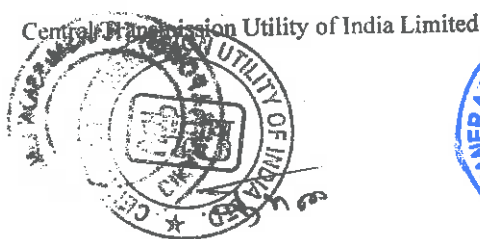

Bikaner A Power Transmission Limited

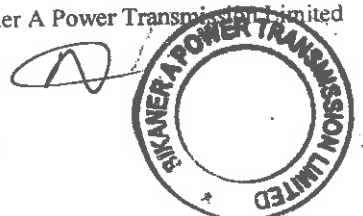

“Day” shall mean a day starting at 0000 hours and ending at 2400 hours;

“D/C” shall mean Double Circuit;

“Designated ISTS Customers” or “DICs” shall have the meaning as ascribed in the Sharing Regulations;

“Dispute” shall mean any dispute or difference of any kind between the Parties, in connection with or arising out of this Agreement including any issue on the interpretation and scope of the terms of this Agreement as provided in Article 16;

“Effective Date” for the purposes of this Agreement, shall have the same meaning as per Article 2.1 of this Agreement;

“Electrical Inspector” shall mean a person appointed as such by the Government under sub-section (1) of Section 162 of the Electricity Act 2003 and also includes Chief Electrical Inspector;

“Electricity Rules 2005” shall mean the rules framed pursuant to the Electricity Act 2003 and as amended from time to time;

“Element” shall mean each Transmission Line or each circuit of the Transmission Lines (where there are more than one circuit) or each bay of Sub-station or switching station or HVDC terminal or inverter station of the Project, including ICTs, Reactors, SVC, FSC, etc. forming part of the ISTS, which will be owned, operated and maintained by the concerned ISTS Licensee, and which has a separate Scheduled COD as per Schedule 2 of this Agreement and has a separate percentage for recovery of Transmission Charges on achieving COD as per Schedule 5 of this Agreement;

“Event of Default” shall mean the events as defined in Article 13 of this Agreement;

“Expiry Date” shall be the date which is thirty-five (35) years from the COD of the Project;

“Financial Closure” shall mean the first Business Day on which funds are made available to the TSP pursuant to the Financing Agreements;

“Financially Evaluated Entity” shall mean the company which has been evaluated for the satisfaction of the financial requirement set forth in the RFP;

“Financing Agreements” shall mean the agreements pursuant to which the TSP is to finance the Project including the loan agreements, security documents, notes, indentures, security agreements, letters of credit and other documents, as may be

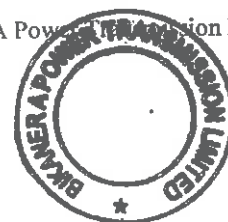
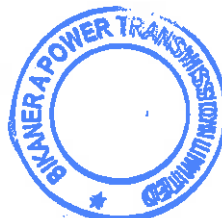
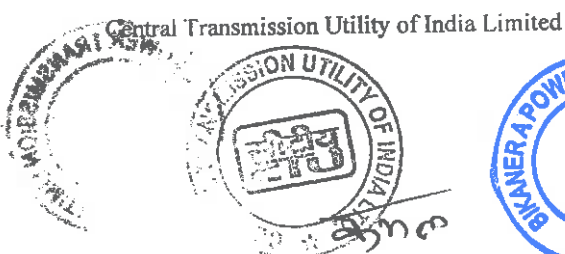

amended, modified, or replaced from time to time, but without in anyway increasing the liabilities of the Designated ISTS Customers / Nodal Agency;

“Financial Year” shall mean a period of twelve months at midnight Indian Standard Time (IST) between 1st April & 31st March;

“Force Majeure” and **“Force Majeure Event”** shall have the meaning assigned thereto in Article 11;

“GOI” shall mean Government of India;

“Grid Code” / “IEGC” shall mean the Grid Code specified by the Central Commission under Clause (h) of sub-section (1) of Section 79 of the Electricity Act;

“Independent Engineer” shall mean an agency/ company, appointed by Nodal Agency in accordance with the Guidelines for Encouraging Competition in Development of Transmission Projects.

“Indian Governmental Instrumentality” shall mean Government of India, Government of any State in India or any ministry, department, board, authority, agency, corporation, commission under the direct or indirect control of Government of India or any State Government or both, any political sub-division of any of them including any court or Commission or tribunal or judicial or quasi-judicial body in India but excluding the CTU, TSP and the Designated ISTS Customers;

“Insurances” shall mean the insurance cover to be obtained and maintained by the TSP in accordance with Article 9 of this Agreement;

“Interconnection Facilities” shall mean the facilities as may be set up for transmission of electricity through the use of the Project, on either one or both side of generating station's / CTU's / STU's / ISTS Licensee's / Designated ISTS Customer's substations (as the case may be) which shall include, without limitation, all other transmission lines, gantries, sub-stations and associated equipments not forming part of the Project;

“ISTS Licensee” shall be the TSP under this Agreement, consequent to having been awarded a Transmission License by the CERC and shall be referred to as the TSP or the ISTS Licensee, as the context may require in this Agreement;

“Law” or **“Laws”** in relation to this Agreement, shall mean all laws including electricity laws in force in India and any statute, ordinance, rule, regulation, notification, order or code, or any interpretation of any of them by an Indian

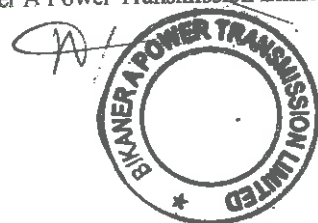
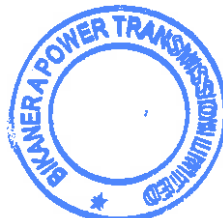

Governmental Instrumentality having force of law and shall include all rules, regulations, decisions and orders of the Commission;

“Lead Member of the Bidding Consortium” or “Lead Member” shall mean a company who commits at least 26% equity stake in the Project, meets the technical requirement as specified in the RFP and so designated by other Member(s) in Bidding Consortium;

“Lenders” means the banks, financial institutions, multilateral funding agencies, non-banking financial companies registered with the Reserve Bank of India (RBI), insurance companies registered with the Insurance Regulatory & Development Authority (IRDA), pension funds regulated by the Pension Fund Regulatory & Development Authority (PFRDA), mutual funds registered with Securities & Exchange Board of India (SEBI), etc., including their successors and assigns, who have agreed on or before COD of the Project to provide the TSP with the debt financing described in the capital structure schedule, and any successor banks or financial institutions to whom their interests under the Financing Agreements may be transferred or assigned;

Provided that, such assignment or transfer shall not relieve the TSP of its obligations to the Nodal Agency under this Agreement in any manner and shall also does not lead to an increase in the liability of the Nodal Agency;

“Lenders Representative” shall mean the person notified by the Lender(s) in writing as being the representative of the Lender(s) or the Security Trustee and such person may from time to time be replaced by the Lender(s) pursuant to the Financing Agreements by written notice to the TSP;

“Letter of Intent” or “LOI” shall have the same meaning as in the RFP;

“Member in a Bidding Consortium / Member” shall mean each company in the Bidding Consortium;

“Month” shall mean a period of thirty (30) days from (and excluding) the date of the event;

“Monthly Transmission Charges” for any Element of the Project, after COD of the Element till COD of the Project, and for the Project after COD of the Project, shall mean the amount of Transmission Charges as specified in Schedule 5 of this Agreement multiplied by no. of days in the relevant month and divided by no. of days in the year;

“National Load Despatch Centre” shall mean the centre established as per sub-section (1) of Section 26 of the Electricity Act 2003;

Central Transmission Utility of India Limited

11

Bikaner A Power Transmission Limited

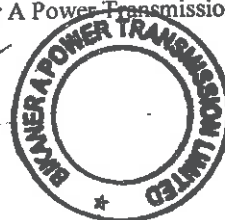
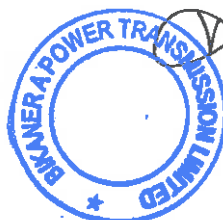
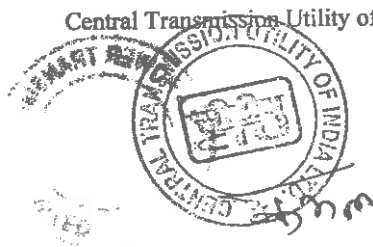

“Nodal Agency” shall mean CTU, which shall execute and implement the Transmission Service Agreement (TSA);

Provided that while taking major decisions, CTU shall consult CEA on technical matters and any other matter it feels necessary.

“Notification” shall mean any notification, issued in the Gazette of India;

“Operating Period” for any Element of the Project shall mean the period from (and including) the COD of such Element of the Project, up to (and including) the Expiry Date and for the Project, shall mean the period from (and including) the COD of the Project, up to (and including) the Expiry Date;

“Parent Company” shall mean an entity that holds at least twenty-six percent (26%) of the paid - up equity capital directly or indirectly in the Bidding Company or in the Member in a Bidding Consortium, as the case may be;

“Preliminary Termination Notice” shall mean a Nodal Agency’s Preliminary Termination Notice as defined in Article 13 of this Agreement;

“Project” shall mean Transmission System for Evacuation of power from Rajasthan REZ Ph-IV (Part-3: 6GW) [Bikaner complex]: Part A, as detailed in Schedule 1 of this Agreement;

“Project Assets” shall mean all physical and other assets relating to and forming part of the Project including:

- (a) rights over the Site for substations, ROW for transmission lines;
- (b) tangible & intangible assets such as civil works and equipment including foundations, embankments, pavements, electrical systems, communication systems, relief centres, administrative offices, Sub-stations, software, tower and sub-stations designs etc;
- (c) project facilities situated on the Site;
- (d) all rights of the TSP under the project agreements;
- (e) financial assets, such as receivables, security deposits etc;
- (f) insurance proceeds; and
- (g) Applicable Permits and authorisations relating to or in respect of the Transmission System;”

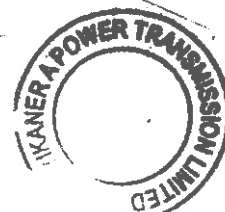
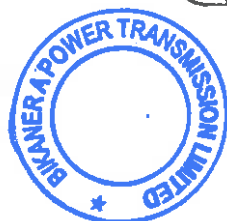
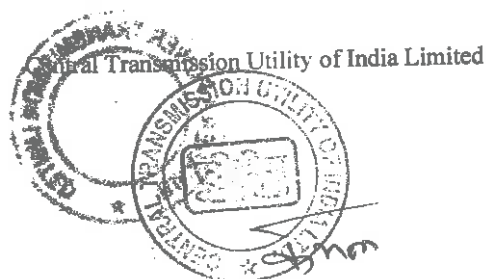

“**Project Execution Plan**” shall mean the plan referred to in Article 3.1.3(c) hereof;

“**Prudent Utility Practices**” shall mean the practices, methods and standards that are generally accepted internationally from time to time by electric transmission utilities for the purpose of ensuring the safe, efficient and economic design, construction, commissioning, operation, repair and maintenance of the Project and which practices, methods and standards shall be adjusted as necessary, to take account of:

- (i) operation, repair and maintenance guidelines given by the manufacturers to be incorporated in the Project,
- (ii) the requirements of Law, and
- (iii) the physical conditions at the Site;
- (iv) the safety of operating personnel and human beings;

“**Rated Voltage**” shall mean voltage at which the Transmission System is designed to operate or such lower voltage at which the line is charged, for the time being, in consultation with the Central Transmission Utility;

“**Rebate**” shall have the meaning as ascribed to in Article 10.3 of this Agreement;

“**RFP**” shall mean Request for Proposal dated 06.06.2024 along with all schedules, annexures and RFP Project Documents attached thereto, issued by the BPC for tariff based competitive bidding process for selection of Bidder as TSP to execute the Project, including any modifications, amendments or alterations thereto;

“**RFP Project Documents**” shall mean the following documents to be entered into in respect of the Project, by the Parties to the respective agreements:

- a. Transmission Service Agreement,
- b. Share Purchase Agreement,
- c. Agreement(s) required under Sharing Regulations and
- d. Any other agreement as may be required;

“**RLDC**” shall mean the relevant Regional Load Dispatch Centre as defined in the Electricity Act, 2003, in the region(s) in which the Project is located;

Central Transmission Utility of India Limited

13

Bikaner A.P. Transmission Limited

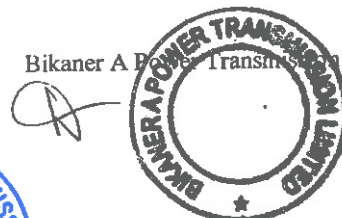
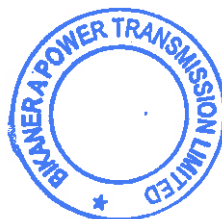

78

“RPC” shall mean the relevant Regional Power Committee established by the Government of India for the specific Region(s) in accordance with the Electricity Act, 2003 for facilitating integrated operation of the Power System in that Region;

“Scheduled COD” in relation to an Element(s) shall mean the date(s) as mentioned in Schedule 2 as against such Element(s) and in relation to the Project, shall mean the date as mentioned in Schedule 2 as against such Project, subject to the provisions of Article 4.4 of this Agreement, or such date as may be mutually agreed among the Parties;

“Scheduled Outage” shall mean the final outage plan as approved by the RPC as per the provisions of the Grid Code;

“Selected Bid” shall mean the technical Bid and the Final Offer of the Selected Bidder submitted during e-reverse bidding, which shall be downloaded and attached in Schedule 7 on or prior to the Effective Date;

“Share Purchase Agreement” shall mean the agreement amongst REC Power Development and Consultancy Limited, Bikaner A Power Transmission Limited and the Successful Bidder for the purchase of one hundred (100%) per cent of the shareholding of the Bikaner A Power Transmission Limited for the Acquisition Price, by the Successful Bidder on the terms and conditions as contained therein;

“Sharing Regulations” shall mean the Central Electricity Regulatory Commission (Sharing of Inter-State Transmission Charges and Losses) Regulations, 2020 and as amended from time to time;

“Site” in relation to a substation, switching station or HVDC terminal or inverter station, shall mean the land and other places upon which such station / terminal is to be established;

“SLDC” shall mean the State Load Despatch Centre established as per sub-section (1) of Section 31 of the Electricity Act 2003;

“STU” or “State Transmission Utility” shall be the Board or the Government company, specified as such by the State Government under sub-section (1) of Section 39 of the Electricity Act 2003;

“Successful Bidder” or “Selected Bidder” shall mean the Bidder selected pursuant to the RFP and who has to acquire one hundred percent (100%) equity shares of Bikaner A Power Transmission Limited along with all its related assets and liabilities, which will be responsible as the TSP to establish the Project on build, own, operate and transfer basis as per the terms of the TSA and other RFP Project Documents;

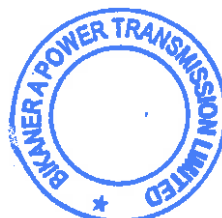
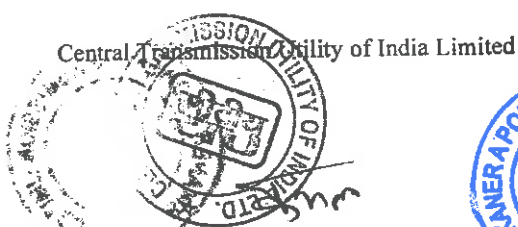

“TSP’s Preliminary Notice” shall mean a notice issued by the TSP in pursuant to the provisions of Article 13.3 of this Agreement;

“Target Availability” shall have the meaning as ascribed hereto in Article 8.2 of this Agreement;

“Technically Evaluated Entity” shall mean the company which has been evaluated for the satisfaction of the technical requirement set forth in RFP;

“Termination Notice” shall mean a Nodal Agency’s Termination Notice given by the Nodal Agency to the TSP pursuant to the provisions of Articles 3.3.2, 3.3.4, 4.4.2, 5.8, 13.2 and 13.3 of this Agreement for the termination of this Agreement;

“Term of Agreement” for the purposes of this Agreement shall have the meaning ascribed thereto in Article 2.2 of this Agreement;

“Transmission Charges” shall mean the Final Offer of the Selected Bidder during the e-reverse bidding and adopted by the Commission, payable to the TSP as per Sharing Regulations;

“Transmission License” shall mean the license granted by the Commission in terms of the relevant regulations for grant of such license issued under the Electricity Act;

“Transmission Service” shall mean making the Project available as per the terms and conditions of this Agreement and Sharing Regulations;

“Unscheduled Outage” shall mean an interruption resulting in reduction of the Availability of the Element(s) / Project (as the case may be) that is not a result of a Scheduled Outage or a Force Majeure Event.

“Ultimate Parent Company” shall mean an entity which owns at least twenty six percent (26%) equity in the Bidding Company or Member of a Consortium, (as the case may be) and in the Technically Evaluated Entity and / or Financially Evaluated Entity (as the case may be) and such Bidding Company or Member of a Consortium, (as the case may be) and the Technically Evaluated Entity and / or Financially Evaluated Entity (as the case may be) shall be under the direct control or indirectly under the common control of such entity;

1.2 Interpretation:

Save where the contrary is indicated, any reference in this Agreement to:

“Agreement” shall be construed as including a reference to its Schedules, Appendices and Annexures;

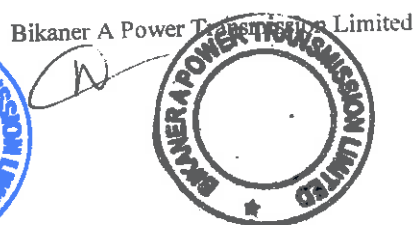
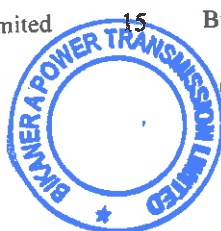
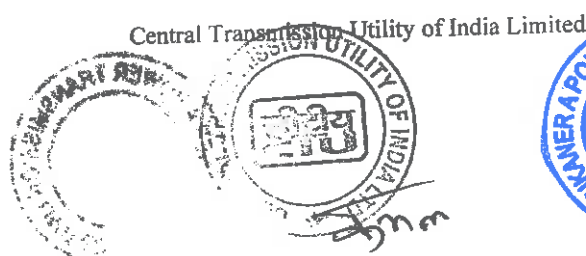

"Rupee", "Rupees" and "Rs." shall denote lawful currency of India;

"crore" shall mean a reference to ten million (10,000,000) and a "lakh" shall mean a reference to one tenth of a million (1,00,000);

"encumbrance" shall be construed as a reference to a mortgage, charge, pledge, lien or other encumbrance securing any obligation of any person or any other type of preferential arrangement (including, without limitation, title transfer and retention arrangements) having a similar effect;

"holding company" of a company or corporation shall be construed as a reference to any company or corporation of which the other company or corporation is a subsidiary;

"indebtedness" shall be construed so as to include any obligation (whether incurred as principal or surety) for the payment or repayment of money, whether present or future, actual or contingent;

"person" shall have the meaning as defined in Section 2 (49) of the Act;

"subsidiary" of a company or corporation (the holding company) shall be construed as a reference to any company or corporation:

- (i) which is controlled, directly or indirectly, by the holding company, or
- (ii) more than half of the issued share capital of which is beneficially owned, directly or indirectly, by the holding company, or
- (iii) which is a subsidiary of another subsidiary of the holding company,

for these purposes, a company or corporation shall be treated as being controlled by another if that other company or corporation is able to direct its affairs and/or to control the composition of its board of directors or equivalent body;

"winding-up", "dissolution", "insolvency", or "reorganization" in the context of a company or corporation shall have the same meaning as defined in the Companies Act, 1956/ Companies Act, 2013 (as the case may be).

1.2.1 Words importing the singular shall include the plural and vice versa.

1.2.2 This Agreement itself or any other agreement or document shall be construed as a reference to this or to such other agreement or document as it may have been, or may from time to time be, amended, varied, novated, replaced or supplemented.

1.2.3 A Law shall be construed as a reference to such Law including its amendments or re-enactments from time to time.

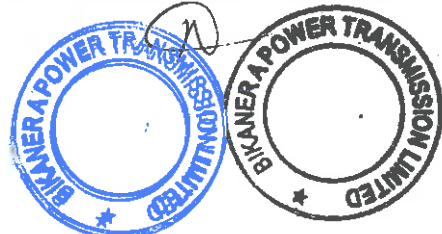
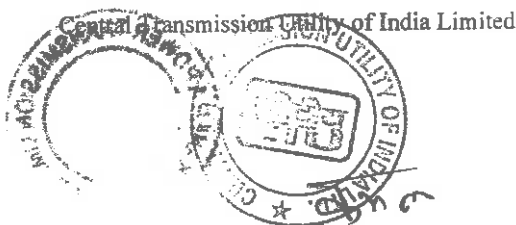

- 1.2.4 A time of day shall, save as otherwise provided in any agreement or document be construed as a reference to Indian Standard Time.
- 1.2.5 Different parts of this Agreement are to be taken as mutually explanatory and supplementary to each other and if there is any inconsistency between or among the parts of this Agreement, they shall be interpreted in a harmonious manner so as to give effect to each part.
- 1.2.6 The tables of contents and any headings or sub-headings in this Agreement have been inserted for ease of reference only and shall not affect the interpretation of this Agreement.
- 1.2.7 All interest payable under this Agreement shall accrue from day to day and be calculated on the basis of a year of three hundred and sixty five (365) days.
- 1.2.8 The words "hereof" or "herein", if and when used in this Agreement shall mean a reference to this Agreement.
- 1.2.9 The contents of Schedule 7 shall be referred to for ascertaining accuracy and correctness of the representations made by the Selected Bidder in Article 17.2.1 hereof.

Central Transmission Utility of India Limited 17 Bikaner A Power Transmission Limited

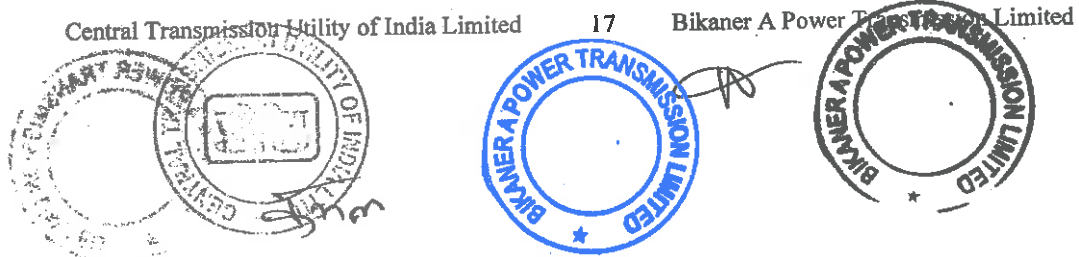

ARTICLE: 2

2 EFFECTIVENESS AND TERM OF AGREEMENT

2.1 Effective Date:

This Agreement shall be effective from later of the dates of the following events:

- a. The Selected Bidder, on behalf of the TSP, has provided the Contract Performance Guarantee, as per terms of Article 3.1 of this Agreement; and
- b. The Selected Bidder has acquired for the Acquisition Price, one hundred percent (100%) of the equity shareholding of REC Power Development and Consultancy Limited, Bikaner A Power Transmission Limited along with all its related assets and liabilities as per the provisions of the Share Purchase Agreement. and
- c. The Agreement is executed and delivered by the Parties;

2.2 Term and Termination:

2.2.1 Subject to Article 2.2.3 and Article 2.4, this Agreement shall continue to be effective in relation to the Project until the Expiry Date, when it shall automatically terminate.

2.2.2 Post the Expiry Date of this Agreement, the TSP shall ensure transfer of Project Assets to CTU or its successors or an agency as decided by the Central Government at zero cost and free from any encumbrance and liability. The transfer shall be completed within 90 days of expiry of this Agreement failing which CTU shall be entitled to take over the Project Assets Suo moto.

2.2.3 This Agreement shall terminate before the Expiry Date in accordance with Article 13 or Article 3.3.2 or Article 3.3.4.

2.3 Conditions prior to the expiry of the Transmission License

2.3.1 In order to continue the Project beyond the expiry of the Transmission License, the TSP shall be obligated to make an application to the Commission at least two (2) years before the date of expiry of the Transmission License, seeking the Commission's approval for the extension of the term of the Transmission License up to the Expiry Date.

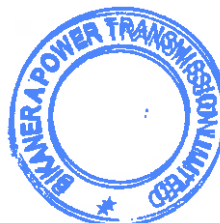
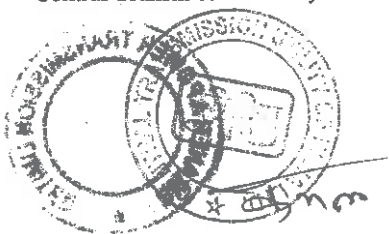

A

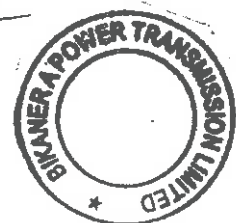

2.3.2 The TSP shall timely comply with all the requirements that may be laid down by the Commission for extension of the term of the Transmission License beyond the initial term of twenty-five (25) years & upto the Expiry Date and the TSP shall keep the Nodal Agency fully informed about the progress on its application for extension of the term of the Transmission License.

2.4 Survival:

The expiry or termination of this Agreement shall not affect any accrued rights, obligations/ roles and liabilities of the Parties under this Agreement, including the right to receive liquidated damages as per the terms of this Agreement. nor shall it effect the survival of any continuing obligations/ roles for which this Agreement provides, either expressly or by necessary implication, which are to survive after the Expiry Date or termination including those under Articles 3.3.3, 3.3.5, Article 9.3 (Application of Insurance Proceeds), Article 11 (Force Majeure), Article 13 (Events of Default and Termination), Article 14 (Liability & Indemnification), Article 16 (Governing Law & Dispute Resolution), Article 19 (Miscellaneous).

2.5 Applicability of the provisions of this Agreement

2.5.1 For the purpose of Availability, Target Availability and the computation of Availability, Incentive, Penalty, the provisions provided in this Agreement shall apply and any future modifications in the relevant Rules and Regulations shall not be applicable for this Project.

2.5.2 For the purposes of this Agreement for ISTS systems developed under the tariff based competitive bidding framework, the provisions relating to the definitions (Availability and COD), Article 3 (Contract Performance Guarantee and Conditions Subsequent), Article 5 (Construction of the Project), Article 6 (Connection and Commissioning of the Project), Article 8 (Target Availability and calculation of Availability), Article 11 (Force Majeure), Article 12 (Change in Law), Article 13 (Event of Default), Article 14 (Indemnification), Article 15 (Assignment and Charges), Articles 16.1, 16.2 and 16.4 (Governing Laws and Dispute Resolution) and Article 17 (representation and warranties of the ISTS Licensee) of this agreement shall supersede the corresponding provisions under Sharing Regulations.

Central Transmission Utility of India Limited

19

Bikaner A Power Transmission Limited

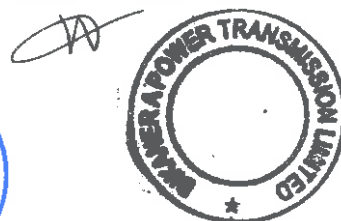
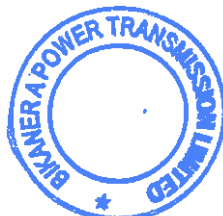
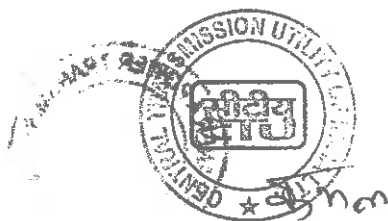

ARTICLE: 3

3 CONDITIONS SUBSEQUENT

3.1 Satisfaction of conditions subsequent by the TSP

3.1.1 Within ten (10) days from the date of issue of Letter of Intent, the Selected Bidder, shall:

- a. Provide the Contract Performance Guarantee, and
- b. Acquire, for the Acquisition Price, one hundred percent (100%) equity shareholding of Bikaner A Power Transmission Limited from REC Power Development and Consultancy Limited, who shall sell to the Selected Bidder, the equity shareholding of Bikaner A Power Transmission Limited, along with all its related assets and liabilities.
- c. Execute this Agreement;

The TSP shall, within five (5) working days from the date of acquisition of SPV by the Selected Bidder, undertake to apply to the Commission for the grant of Transmission License and for the adoption of tariff as required under section-63 of the Electricity Act.

The Selected Bidder, on behalf of the TSP, will provide to the Central Transmission Utility of India Limited (being the Nodal Agency) the Contract Performance Guarantee for an amount of Rs. 157.50 Crore (Rupees One Hundred Fifty Seven Crore Fifty lakh Only).

3.1.2 The Contract Performance Guarantee shall be initially valid for a period up to three (3) months after the Scheduled COD of the Project and shall be extended from time to time to be valid for a period up to three (3) months after the COD of the Project. In case the validity of the Contract Performance Guarantee is expiring before the validity specified in this Article, the TSP shall, at least thirty (30) days before the expiry of the Contract Performance Guarantee, replace the Contract Performance Guarantee with another Contract Performance Guarantee or extend the validity of the existing Contract Performance Guarantee until the validity period specified in this Article.

3.1.3 The TSP agrees and undertakes to duly perform and complete the following activities within six (6) months from the Effective Date (except for c) below), unless such completion is affected due to any Force Majeure Event, or if any of the activities is specifically waived in writing by the Nodal Agency:

Central Transmission Utility of India Limited

20

Bikaner A Power Transmission Limited

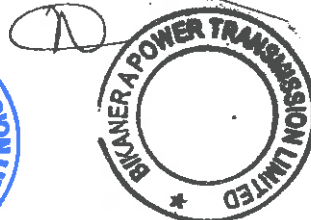
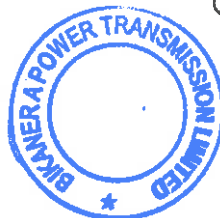
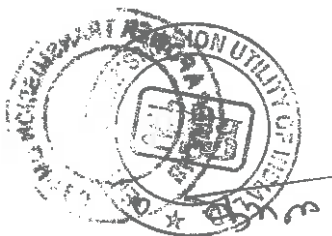

- a. To obtain the Transmission License for the Project from the Commission;
- b. To obtain the order for adoption of Transmission Charges by the Commission, as required under Section 63 of the Electricity Act 2003;
- c. To submit to the Nodal Agency, CEA & Independent Engineer, the Project Execution Plan, immediately after award of contract(s) and maximum within one hundred and twenty (120) days from the Effective Date. Also, an approved copy each of Manufacturing Quality Plan (MQP) and Field Quality Plan (FQP) would be submitted to Independent Engineer & Nodal Agency in the same time period. The TSP's Project Execution Plan should be in conformity with the Scheduled COD as specified in Schedule 2 of this Agreement, and shall bring out clearly the organization structure, time plan and methodology for executing the Project, award of major contracts, designing, engineering, procurement, shipping, construction, testing and commissioning to commercial operation;
- d. To submit to the Nodal Agency, CEA & Independent Engineer a detailed bar (GANTT) chart of the Project outlining each activity (taking longer than one Month), linkages as well as durations;
- e. To submit to the Nodal Agency, CEA & Independent Engineer detailed specifications of conductor meeting the functional specifications specified in RFP;
- f. To achieve Financial Closure;
- g. To provide an irrevocable letter to the Lenders duly accepting and acknowledging the rights provided to the Lenders under the provisions of Article 15.3 of this Agreement and all other RFP Project Documents;
- h. To award the Engineering, Procurement and Construction contract ("EPC contract") for the design and construction of the Project and shall have given to such Contractor an irrevocable notice to proceed; and
- i. To sign the Agreement(s) required, if any, under Sharing Regulations.

3.2 Recognition of Lenders' Rights by the Nodal Agency

- 3.2.1 The Nodal Agency hereby accepts and acknowledges the rights provided to the Lenders as per Article 15.3 of this Agreement and all other RFP Project Documents.

Central Transmission Utility of India Limited

21

Bikaner A Power Transmission Limited

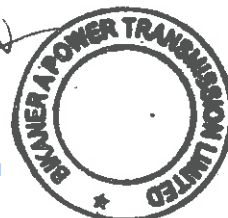
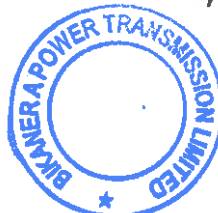
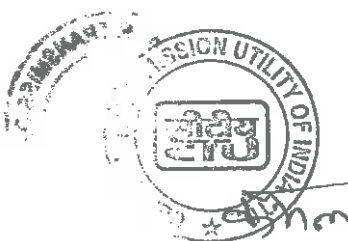

86

3.3 Consequences of non-fulfilment of conditions subsequent

3.3.1 If any of the conditions specified in Article 3.1.3 is not duly fulfilled by the TSP even within three (3) Months after the time specified therein, then on and from the expiry of such period and until the TSP has satisfied all the conditions specified in Article 3.1.3, the TSP shall, on a monthly basis, be liable to furnish to Central Transmission Utility of India Limited (being the Nodal Agency) additional Contract Performance Guarantee of Rupees Fifteen Crore Seventy Five Lakh Only (Rs. 15.75 Crore) within two (2) Business Days of expiry of every such Month. Such additional Contract Performance Guarantee shall be provided to Central Transmission Utility of India Limited (being the Nodal Agency) in the manner provided in Article 3.1.1 and shall become part of the Contract Performance Guarantee and all the provisions of this Agreement shall be construed accordingly. Central Transmission Utility of India Limited (being the Nodal Agency) shall be entitled to hold and / or invoke the Contract Performance Guarantee, including such additional Contract Performance Guarantee, in accordance with the provisions of this Agreement.

3.3.2 Subject to Article 3.3.4, if:

- (i) the fulfilment of any of the conditions specified in Article 3.1.3 is delayed beyond nine (9) Months from the Effective Date and the TSP fails to furnish additional Contract Performance Guarantee to the Nodal Agency in accordance with Article 3.3.1 hereof; or
- (ii) the TSP furnishes additional Performance Guarantee to the Nodal Agency in accordance with Article 3.3.1 hereof but fails to fulfil the conditions specified in Article 3.1.3 within a period of twelve (12) months from the Effective Date,

the Nodal Agency shall have the right to terminate this Agreement, by giving a Termination Notice to the TSP, in writing, of at least seven (7) days, with a copy to CEA and the Lenders' Representative in order to enable the Lenders to exercise right of substitution in accordance with Article 15.3 of this Agreement.

3.3.3 If the Nodal Agency elects to terminate this Agreement as per the provisions of Article 3.3.2, the TSP shall be liable to pay to the Nodal Agency an amount of Rs. 157.50 Crore (Rupees One Hundred Fifty Seven Crore Fifty lakh Only) as liquidated damages. The Nodal Agency shall be entitled to recover this amount of damages by invoking the Contract Performance Guarantee to the extent of liquidated damages, which shall be required by the Nodal Agency, and the balance shall be returned to TSP, if any.

Central Transmission Utility of India Limited

22

Bikaner A Power Transmission Limited

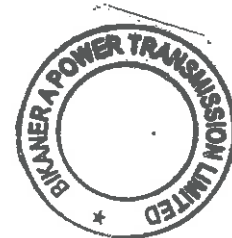
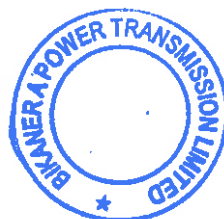

It is clarified for removal of doubt that this Article shall survive the termination of this Agreement.

- 3.3.4 In case of inability of the TSP to fulfil the conditions specified in Article 3.1.3 due to any Force Majeure Event, the time period for fulfilment of the condition subsequent as mentioned in Article 3.1.3, may be extended for a period of such Force Majeure Event. Alternatively, if deemed necessary, this Agreement may be terminated by the Nodal Agency by giving a Termination Notice to the TSP, in writing, of at least seven (7) days, with a copy to CEA and the Lenders' Representative in order to enable the Lenders to exercise right of substitution in accordance with Article 15.3 of this Agreement and the Contract Performance Guarantee shall be returned as per the provisions of Article 6.5.1.

Provided, that due to the provisions of this Article 3.3.4, any increase in the time period for completion of conditions subsequent mentioned under Article 3.1.3, shall lead to an equal increase in the time period for the Scheduled COD. If the Scheduled COD is extended beyond a period of one hundred eighty (180) days due to the provisions of this Article 3.3.4, the TSP will be allowed to recover the interest cost during construction corresponding to the period exceeding one hundred eighty (180) days by adjustment in the Transmission Charges in accordance with Schedule 9.

- 3.3.5 Upon termination of this Agreement as per Articles 3.3.2 and 3.3.4, the Nodal Agency may take steps to bid out the Project again.
- 3.3.6 The Nodal agency, on the failure of the TSP to fulfil its obligations, if it considers that there are sufficient grounds for so doing, apart from invoking the Contract Performance Guarantee under para 3.3.3 may also initiate proceedings for blacklisting the TSP as per provisions of Article 13.2 of TSA.

3.4 Progress Reports

The TSP shall notify the Nodal Agency and CEA in writing at least once a Month on the progress made in satisfying the conditions subsequent in Articles 3.1.3.

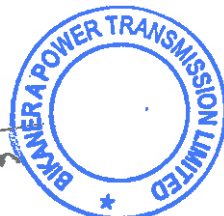

ARTICLE: 4

4 DEVELOPMENT OF THE PROJECT

4.1 TSP's obligations in development of the Project:

Subject to the terms and conditions of this Agreement, the TSP at its own cost and expense shall observe, comply with, perform, undertake and be responsible:

- a. for procuring and maintaining in full force and effect all Consents, Clearances and Permits, required in accordance with Law for development of the Project;
- b. for financing, constructing, owning and commissioning each of the Element of the Project for the scope of work set out in Schedule 1 of this Agreement in accordance with:

- i. the Electricity Act and the Rules made thereof;
- ii. the Grid Code;
- iii. the CEA Regulations applicable, and as amended from time to time, for Transmission Lines and sub-stations:

- the Central Electricity Authority (Technical Standards for Connectivity to the Grid) Regulations, 2007;
- Central Electricity Authority (Technical Standards for construction of Electrical Plants and Electric Lines) Regulation, 2010;
- Central Electricity Authority (Grid Standard) Regulations, 2010;
- Central Electricity Authority (Safety requirements for construction, operation and maintenance of Electrical Plants and Electrical Lines) Regulation, 2011;
- Central Electricity Authority (Measures relating to Safety and Electricity Supply) Regulation, 2010;
- Central Electricity Authority (Technical Standards for Communication System in Power System Operation) Regulations, 2020.

- iv. Safety/ security Guidelines laid down by the Government;

Central Transmission Utility of India Limited

24

Bikaner A Power Transmission Limited

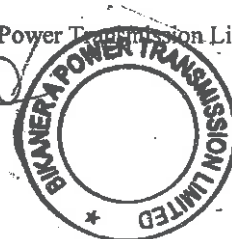
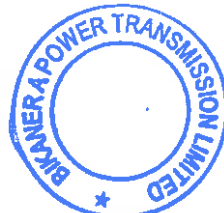
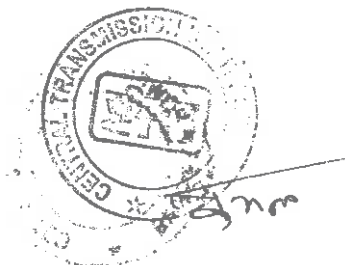

89

- v. Prudent Utility Practices, relevant Indian Standards and the Law;

not later than the Scheduled COD as per Schedule 2 of this Agreement;

- c. for entering into a Connection Agreement with the concerned parties in accordance with the Grid Code.
- d. for owning the Project throughout the term of this Agreement free and clear of any encumbrances except those expressly permitted under Article 15 of this Agreement;
- e. to co-ordinate and liaise with concerned agencies and provide on a timely basis relevant information with regard to the specifications of the Project that may be required for interconnecting the Project with the Interconnection Facilities;
- f. for providing all assistance to the Arbitrators as they may require for the performance of their duties and responsibilities;
- g. to provide to the Nodal Agency and CEA, on a monthly basis, progress reports with regard to the Project and its execution (in accordance with prescribed form) to enable the CEA to monitor and co-ordinate the development of the Project matching with the Interconnection Facilities;
- h. to comply with Ministry of Power order no. 25-11/6/2018 – PG dated 02.07.2020 as well as other Guidelines issued by Govt. of India pertaining to this;
- i. to procure the products associated with the Transmission System as per provisions of Public Procurement (Preference to Make in India) orders issued by Ministry of Power vide orders No. 11/5/2018 - Coord. dated 28.07.2020 for transmission sector, as amended from time to time read with Department for Promotion of Industry and Internal Trade (DPIIT) orders in this regard (Procuring Entity as defined in above orders shall deemed to have included Selected Bidder and/ or TSP).

Also, to comply with Department of Expenditure, Ministry of Finance vide Order (Public Procurement No 1) bearing File No. 6/18/2019-PPD dated 23.07.2020, Order (Public Procurement No 2) bearing File No. 6/18/2019-PPD dated 23.07.2020 and Order (Public Procurement No. 3) bearing File No. 6/18/2019-PPD, dated 24.07.2020, as amended from time to time, regarding public procurement from a bidder of a country, which shares land border with India;

Central Transmission Utility of India Limited

25

Bikaner A Power Transmission Limited

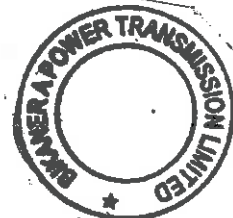
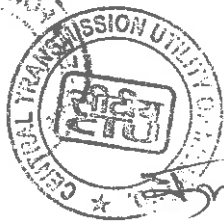

- j. to submit to Nodal Agency information in the prescribed format [To be devised by Nodal Agency] for ensuring compliance to Article 4.1 i) above.
- k. to comply with all its obligations undertaken in this Agreement.

4.2 Roles of the Nodal Agency in implementation of the Project:

4.2.1 Subject to the terms and conditions of this Agreement, the Nodal Agency shall be the holder and administrator of this Agreement and shall inter alia:

- a. appoint an Independent Engineer within 90 days of the Effective Date
- b. provide letters of recommendation to the concerned Indian Governmental Instrumentality, as may be requested by the TSP from time to time, for obtaining the Consents, Clearances and Permits required for the Project;
- c. coordinate among TSP and upstream/downstream entities in respect of Interconnection Facilities; and
- d. monitor the implementation of the Agreement and take appropriate action for breach thereof including revocation of guarantees, cancellation of Agreement, blacklisting etc
- e. provide all assistance to the Arbitrators as required for the performance of their duties and responsibilities; and
- f. perform any other responsibility (ies) as specified in this Agreement.

4.3 Time for Commencement and Completion:

- a. The TSP shall take all necessary steps to commence work on the Project from the Effective Date of the Agreement and shall achieve Scheduled COD of the Project in accordance with the time schedule specified in Schedule 2 of this Agreement;
- b. The COD of each Element of the Project shall occur no later than the Scheduled COD or within such extended time to which the TSP shall be entitled under Article 4.4 hereto.

4.4 Extension of time:

4.4.1 In the event that the TSP is unable to perform its obligations for the reasons solely attributable to the Nodal Agency, the Scheduled COD shall be extended, by a 'day to day' basis, subject to the provisions of Article 13.

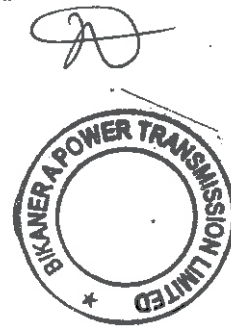
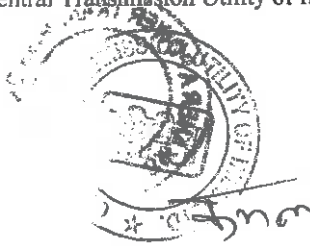

91

4.4.2 In the event that an Element or the Project cannot be commissioned by its Scheduled COD on account of any Force Majeure Event as per Article 11, the Scheduled COD shall be extended, by a 'day to day' basis for a period of such Force Majeure Event. Alternatively, if deemed necessary, the Nodal Agency may terminate the Agreement as per the provisions of Article 13.4 by giving a Termination Notice to the TSP, in writing, of at least seven (7) days, with a copy to CEA and the Lenders' Representative in order to enable the Lenders to exercise right of substitution in accordance with Article 15.3 of this Agreement.

4.4.3 If the Parties have not agreed, within thirty (30) days after the affected Party's performance has ceased to be affected by the relevant circumstance, on how long the Scheduled COD should be deferred by, any Party may raise the Dispute to be resolved in accordance with Article 16.

4.5 Metering Arrangements:

4.5.1 The TSP shall comply with all the provisions of the IEGC and the Central Electricity Authority (Installation and Operation of Meters) Regulations, 2006 as amended from time to time, with regard to the metering arrangements for the Project. The TSP shall fully cooperate with the CTU / STU / RLDC and extend all necessary assistance in taking meter readings.

4.6 Interconnection Facilities:

4.6.1 Subject to the terms and conditions of this Agreement, the TSP shall be responsible for connecting the Project with the interconnection point(s) specified in Schedule 1 of this Agreement. The Interconnection Facilities shall be developed as per the scope of work and responsibilities assigned in Schedule 1 of this Agreement. The Nodal Agency shall be responsible for coordinating to make available the Interconnection Facilities.

4.6.2 In order to remove any doubts, it is made clear that the obligation of the TSP within the scope of the project is to construct the Project as per Schedule-1 of this Agreement and in particular to connect it to the Interconnection Facilities as specified in this Agreement.

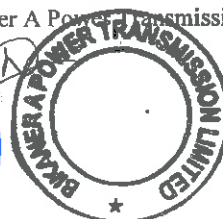
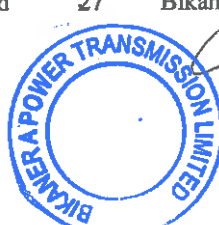

ARTICLE: 5

5 CONSTRUCTION OF THE PROJECT

5.1 TSP's Construction Responsibilities:

5.1.1 The TSP, at its own cost and expense, shall be responsible for designing, constructing, erecting, testing and commissioning each Element of the Project by the Scheduled COD in accordance with the Regulations and other applicable Laws specified in Article 4.1 of this Agreement.

5.1.2 The TSP acknowledges and agrees that it shall not be relieved from any of its obligations under this Agreement or be entitled to any extension of time or any compensation whatsoever by reason of the unsuitability of the Site or Transmission Line route(s).

5.1.3 The TSP shall be responsible for obtaining all Consents, Clearances and Permits related but not limited to road / rail / river / canal / power line / crossings, Power and Telecom Coordination Committee (PTCC), defence, civil aviation, right of way / way-leaves and environmental & forest clearances from relevant authorities required for developing, financing, constructing, maintaining/ renewing all such Consents, Clearances and Permits in order to carry out its obligations under this Agreement in general and shall furnish to the Nodal Agency such copy/ies of each Consents, Clearances and Permits, on demand. Nodal Agency shall provide letters of recommendation to the concerned Indian Governmental Instrumentality, as may be requested by the TSP from time to time, for obtaining the Consents, Clearances and Permits required for the Project.

5.1.4 The TSP shall be responsible for:

(a) acquisition of land for location specific substations, switching stations or HVDC terminal or inverter stations. Also, the actual location of Greenfield substations (Switching Stations or HVDC Terminal or Inverter Stations) for a generation pooling substation and for load serving substations in the scope of TSP shall not be beyond 3 Km radius of the location proposed by the BPC in the survey report. However, actual location of any Greenfield Intermediate Substations in the scope of TSP shall not be beyond 10 Km radius of the location proposed by the BPC in the Survey Report;

(b) final selection of Site including its geo-technical investigation;

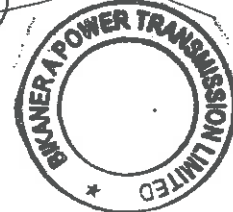

- (c) survey and geo-technical investigation of line route in order to determine the final route of the Transmission Lines;
- (d) seeking access to the Site and other places where the Project is being executed, at its own risk and costs, including payment of any crop, tree compensation or any other compensation as may be required.

5.1.5 In case the Project involves any resettlement and rehabilitation, the resettlement and rehabilitation package will be implemented by the State Government authorities, for which the costs is to be borne by the TSP and no changes would be allowed in the Transmission Charges on account of any variation in the resettlement and rehabilitation cost. The TSP shall provide assistance on best endeavour basis, in implementation of the resettlement and rehabilitation package, if execution of such package is in the interest of expeditious implementation of the Project and is beneficial to the Project affected persons.

5.2 Appointing Contractors:

- 5.2.1 The TSP shall conform to the requirements as provided in this Agreement while appointing Contractor(s) for procurement of goods & services.
- 5.2.2 The appointment of such Contractor(s) shall neither relieve the TSP of any of its obligations under this Agreement nor make the Nodal Agency liable for the performance of such Contractor(s).

5.3 Monthly Progress Reporting:

The TSP shall provide to the CEA, Nodal Agency & Independent Engineer, on a monthly basis, progress reports along with likely completion date of each Element with regard to the Project and its execution (in accordance with prescribed form). The Nodal Agency/ CEA shall monitor the development of the Project for its timely completion for improving and augmenting the electricity system as a part of its statutory responsibility.

5.4 Quality of Workmanship:

The TSP shall ensure that the Project is designed, built and completed in a good workmanship using sound engineering and construction practices, and using only materials and equipment that are new and manufactured as per the MQP and following approved FQP for erection, testing & commissioning and complying with Indian /International Standards such that, the useful life of the Project will be at least thirty-five (35) years from the COD of the Project.

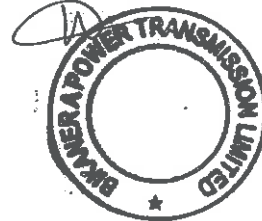
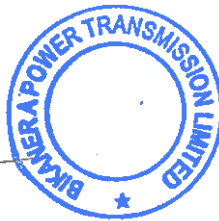
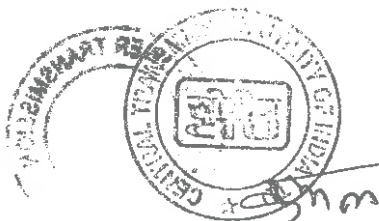

The TSP shall ensure that all major substation equipment / component (e.g. transformers, reactors, Circuit Breakers, Instrument Transformers (IT), Surge Arresters (SA), Protection relays, clamps & connectors etc.), equipment in terminal stations of HVDC installations including Thyristor/ IGBT valves, Converter Transformers, smoothing reactors, Transformer bushings and wall bushings, GIS bus ducts, towers and gantry structures and transmission towers or poles and line materials (conductors, earthwire, OPGW, insulator, accessories for conductors, OPGW & earthwires, hardware fittings for insulators, aviation lights etc), facilities and system shall be designed, constructed and tested (Type test, Routine tests, Factory Acceptance Test (FAT)) in accordance with relevant CEA Regulations and Indian Standards. In case Indian Standards for any particular equipment/ system/ process is not available, IEC/ IEEE or equivalent International Standards and Codes shall be followed.

5.5 Progress Monitoring & Quality Assurance:

- 5.5.1 The Project Execution Plan submitted by the TSP in accordance with Article 3.1.3 c) shall comprise of detailed schedule of all the equipments/items /materials required for the Project, right from procurement of raw material till the dispatch from works and receipt at the site. Further, it should also include various stages of the construction schedule up to the commissioning of the Project.
- 5.5.2 Nodal Agency, CEA & Independent Engineer shall have access at all reasonable times to the Site and to the Manufacturer's works and to all such places where the Project is being executed.
- 5.5.3 Independent Engineer shall ensure conformity of the conductor specifications with the functional specifications specified in RFP.
- 5.5.4 The Independent Engineer shall monitor the following during construction of the Project:
- a) Quality of equipments, material, foundation, structures and workmanship etc. as laid down in Article 5.4 and 6.1.4 of the TSA. Specifically, quality of Sub-station equipments, transmission line material and workmanship etc. would be checked in accordance with the Article 5.4.
 - b) Progress in the activities specified in Condition Subsequent
 - c) Verification of readiness of the elements including the statutory clearances & completion of civil works, fixing of all components and finalisation of punch points (if any) prior to charging of the elements

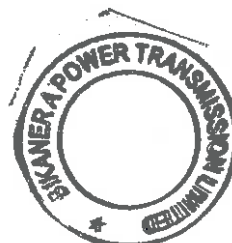
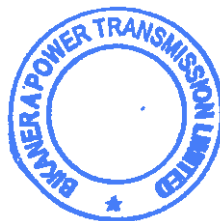
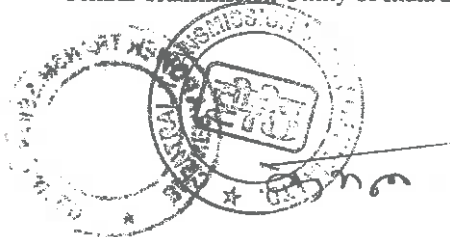

95

d) Progress of construction of substation and Transmission Lines

5.5.5 The progress shall be reviewed by the Independent Engineer against the Project Execution Plan. The Independent Engineer shall prepare its report on monthly basis and submit the same to Nodal Agency highlighting the progress achieved till the end of respective month vis-à-vis milestone activities, areas of concern, if any, which may result in delay in the timely completion of the Project. Based on the progress, Nodal Agency and/ or CEA shall issue written instructions to the TSP to take corrective measures, as may be prudent for the timely completion of the Project. In case of any deficiency, the Nodal Agency would be at liberty to take action in accordance with the procedure of this Agreement.

5.5.6 For any delay in commissioning any critical Element(s), as identified in Schedule 1 & Schedule 2 of this Agreement, beyond a period of 45 days shall lead to a sequestration of 10% of the Contract Performance Guarantee.

5.6 Site regulations and Construction Documents

The TSP shall abide by the Safety Rules and Procedures as mentioned in Schedule 3 of this Agreement

The TSP shall retain at the Site and make available for inspection at all reasonable times, copies of the Consents, Clearances and Permits, construction drawings and other documents related to construction.

5.7 Supervision of work:

The TSP shall provide all necessary superintendence for execution of the Project and its supervisory personnel shall be available to provide full-time superintendence for execution of the Project. The TSP shall provide skilled personnel who are experienced in their respective fields.

5.8 Remedial Measures:

The TSP shall take all necessary actions for remedying the shortfall in achievement of timely progress in execution of the Project, if any, as intimated by the Independent Engineer and/ or CEA and/ or the Nodal Agency. However, such intimation by the Independent Engineer and/ or CEA and/ or the Nodal Agency and the subsequent effect of such remedial measures carried out by the TSP shall not relieve the TSP of its obligations in the Agreement. Independent Engineer and/ or CEA and/ or the Nodal Agency may carry out random inspections during the Project execution, as and when deemed necessary by it. If the shortfalls as intimated to the TSP are not remedied to the satisfaction of the CEA and/ or the Nodal Agency, this Agreement may be terminated by the Nodal Agency by giving a Termination Notice to the TSP, in writing,

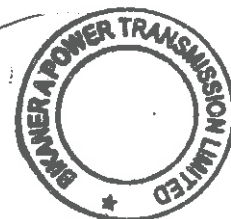
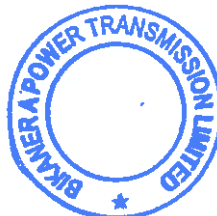
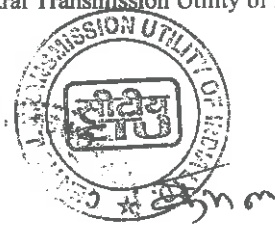

of at least seven (7) days, with a copy to CEA and the Lenders' Representative in order to enable the Lenders to exercise right of substitution in accordance with Article 15.3 of this Agreement.

Central Transmission Utility of India Limited

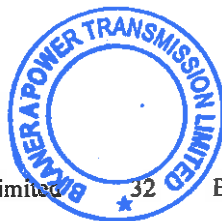

32

Bikaner A Power Transmission Limited

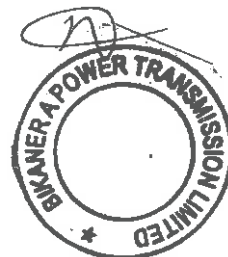

ARTICLE: 6

6 CONNECTION AND COMMISSIONING OF THE PROJECT

6.1 Connection with the Inter-Connection Facilities:

6.1.1 The TSP shall give the RLDC(s), CTU, / STU, as the case may be, and any other agencies as required, at least sixty (60) days advance written notice of the date on which it intends to connect an Element of the Project, which date shall not be earlier than its Scheduled COD or Schedule COD extended as per Article 4.4.1 & 4.4.2 of this Agreement, unless mutually agreed to by Parties. Further, any preponing of COD of any element prior to Scheduled COD must be approved by the Nodal Agency.

6.1.2 The RLDC / SLDC (as the case may be) or the CTU / STU (as the case may be), for reasonable cause, including non-availability of Interconnection Facilities as per Article 4.2, can defer the connection for up to fifteen (15) days from the date notified by the TSP pursuant to Article 6.1.1, if it notifies to the TSP in writing, before the date of connection, of the reason for the deferral and when the connection is to be rescheduled. However, no such deferment on one or more occasions would be for more than an aggregate period of thirty (30) days. Further, the Scheduled COD would be extended as required, for all such deferments on "day to day" basis.

6.1.3 Subject to Articles 6.1.1 and 6.1.2, any Element of Project may be connected with the Interconnection Facilities when:

- a. it has been completed in accordance with this Agreement and the Connection Agreement;
- b. it meets the Grid Code, Central Electricity Authority (Technical Standards for Connectivity to the Grid) Regulations, 2007 as amended from time to time and all other Indian legal requirements, and
- c. The TSP has obtained the approval in writing of the Electrical Inspector certifying that the Element is ready from the point of view of safety of supply and can be connected with the Interconnection Facilities.
- d. It has satisfactorily met all the testing requirements as per Articles 6.1.4

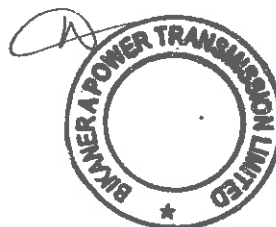
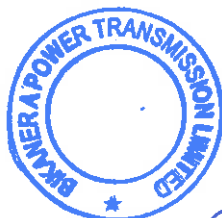
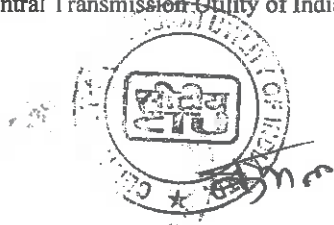

6.1.4 Site Acceptance Test (SAT)/ pre-commissioning tests of all major substation equipment, component, system, facilities shall be successfully carried out before commissioning. The Type tests, FAT and SAT reports should be available at the substation / terminal station of HVDC installations for ready reference of operation and maintenance staff and has to be made available to the Independent Engineer appointed for quality monitoring or their authorised representatives, as and when they wish to examine the same.

6.2 Commercial Operation:

6.2.1 An Element of the Project shall be declared to have achieved COD twenty-four (24) hours following the connection of the Element with the Interconnection Facilities pursuant to Article 6.1 or seven (7) days after the date on which it is declared by the TSP to be ready for charging but is not able to be charged for reasons not attributable to the TSP subject to Article 6.1.2.

Provided that an Element shall be declared to have achieved COD only after all the Element(s), if any, which are pre-required to have achieved COD as defined in Schedule 2 of this Agreement, have been declared to have achieved their respective COD.

6.2.2 Once any Element of the Project has been declared to have achieved deemed COD as per Article 6.2.1 above, such Element of the Project shall be deemed to have Availability equal to the Target Availability till the actual charging of the Element and to this extent, TSP shall be eligible for the Monthly Transmission Charges applicable for such Element

6.3 Compensation for Direct Non Natural Force Majeure Event or Indirect Non Natural Force Majeure Event or Natural Force Majeure Event (affecting the Nodal Agency)

6.3.1 If the TSP is otherwise ready to connect the Element(s) of the Project and has given due notice, as per provisions of Article 6.1.1, to the concerned agencies of the date of intention to connect the Element(s) of the Project, where such date is not before the Scheduled COD, but is not able to connect the Element(s) of the Project by the said date specified in the notice, due to Direct Non Natural Force Majeure Event or Indirect Non Natural Force Majeure Event or Natural Force Majeure Event affecting the Nodal Agency, provided such Direct Non Natural Force Majeure Event or Indirect Non Natural Force Majeure Event or Natural Force Majeure Event affecting the Nodal Agency has continued for a period of more than three (3) continuous or non-continuous Months, the TSP shall, until the effects of the Direct Non Natural Force Majeure Event or of Indirect Non Natural

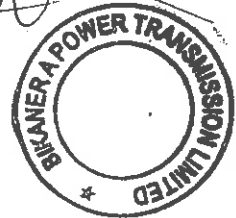

Force Majeure Event or Natural Force Majeure Event affecting the Nodal Agency no longer prevent the TSP from connecting the Element(s) of the Project, be deemed to have achieved COD relevant to that date and to this extent, be deemed to have been providing Transmission Service with effect from the date notified, and shall be treated as follows:

- a. In case of delay due to Direct Non Natural Force Majeure Event, TSP is entitled for Transmission Charges calculated on Target Availability for the period of such events in excess of three (3) continuous or non-continuous Months in the manner provided in (c) below.
- b. In case of delay due to Indirect Non Natural Force Majeure Event or Natural Force Majeure Event affecting the Nodal Agency, TSP is entitled for payment for debt service which is due under the Financing Agreements, subject to a maximum of Transmission Charges calculated on Target Availability, for the period of such events in excess of three (3) continuous or non-continuous Months in the manner provided in (c) below.
- c. In case of delay due to Direct Non Natural Force Majeure Event or Indirect Non Natural Force Majeure Event or Natural Force Majeure Event affecting the Nodal Agency, the TSP is entitled for payments mentioned in (a) and (b) above, after commencement of Transmission Service, in the form of an increase in Transmission Charges. These amounts shall be paid from the date, being the later of a) the date of cessation of such Indirect Non Natural Force Majeure Event or Natural Force Majeure Event affecting the Nodal Agency and b) the completion of sixty (60) days from the receipt of the Financing Agreements by the Nodal Agency from the TSP.

Provided such increase in Transmission Charges shall be so as to put the TSP in the same economic position as the TSP would have been in case the TSP had been paid amounts mentioned in (a) and (b) above in a situation where the Force Majeure Event had not occurred.

For the avoidance of doubt, it is clarified that the charges payable under this Article 6.3.1 shall be recovered as per Sharing Regulations.

6.4 Liquidated Damages for Delay in achieving COD of Project:

- 6.4.1 If the TSP fails to achieve COD of any Element of the Project or the Project, by the Element's / Project's Scheduled COD or such Scheduled COD as extended under Articles 4.4.1 and 4.4.3, then the TSP shall pay to the Nodal Agency, a

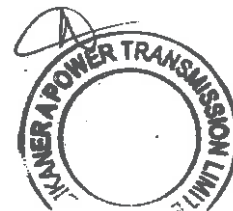
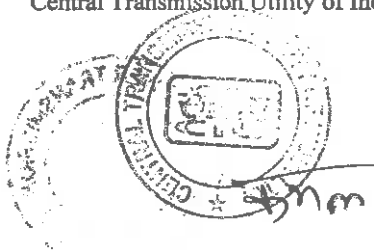

sum equivalent to 3.33% of Monthly Transmission Charges applicable for the Element of the Project [in case where no Elements have been defined, to be on the Project as a whole] / Project, for each day of delay up to sixty (60) days of delay and beyond that time limit, at the rate of five percent (5%) of the Monthly Transmission Charges applicable to such Element / Project, as liquidated damages for such delay and not as penalty, without prejudice to any rights of the Nodal Agency under the Agreement.

- 6.4.2 The TSP's maximum liability under this Article 6.4 shall be limited to the amount of liquidated damages calculated in accordance with Article 6.4.1 for and up to six (6) months of delay for the Element or the Project.

Provided that, in case of failure of the TSP to achieve COD of the Element of the Project even after the expiry of six (6) months from its Scheduled COD, the provisions of Article 13 shall apply.

- 6.4.3 The TSP shall make payment to the Nodal Agency of the liquidated damages calculated pursuant to Article 6.4.1 within ten (10) days of the earlier of:
- the date on which the applicable Element achieves COD; or
 - the date of termination of this Agreement.

The payment of such damages shall not relieve the TSP from its obligations to complete the Project or from any other obligation and liabilities under the Agreement.

- 6.4.4 If the TSP fails to pay the amount of liquidated damages to the Nodal Agency within the said period of ten (10) days, the Nodal Agency shall be entitled to recover the said amount of the liquidated damages by invoking the Contract Performance Guarantee. If the then existing Contract Performance Guarantee is for an amount which is less than the amount of the liquidated damages payable by the TSP to the Nodal Agency under this Article 6.3 and the TSP fails to make payment of the balance amount of the liquidated damages not covered by the Contract Performance Guarantee, then such balance amount shall be deducted from the Transmission Charges payable to the TSP. The right of the Nodal Agency to encash the Contract Performance Guarantee is without prejudice to the other rights of the Nodal Agency under this Agreement.

- 6.4.5 For avoidance of doubt, it is clarified that amount payable by TSP under this Article is over and above the penalty payable by TSP under Article 5.5.6 of this Agreement.

Central Transmission Utility of India Limited

36

Bikaner A Power Transmission Limited

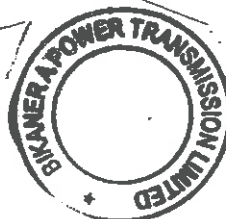
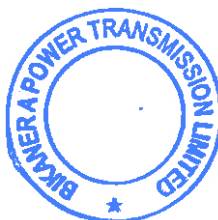
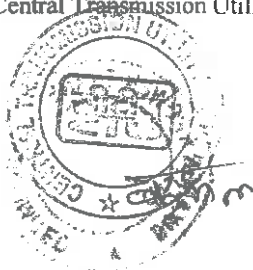

6.5 Return of Contract Performance Guarantee

- 6.5.1 The Contract Performance Guarantee as submitted by TSP in accordance with Article 3.1.1 shall be released by the Nodal Agency within three (3) months from the COD of the Project. In the event of delay in achieving Scheduled COD of any of the Elements by the TSP (otherwise than due to reasons as mentioned in Article 3.1.3 or Article 11) and consequent part invocation of the Contract Performance Guarantee by the Nodal Agency, Nodal Agency shall release the Contract Performance Guarantee, if any remaining unadjusted, after the satisfactory completion by the TSP of all the requirements regarding achieving the Scheduled COD of the remaining Elements of the Project. It is clarified that the Nodal Agency shall also return / release the Contract Performance Guarantee in the event of (i) applicability of Article 3.3.2 to the extent the Contract Performance Guarantee is valid for an amount in excess of Rs.157.50 Crore (Rupees One Hundred Fifty Seven Crore Fifty lakh Only), or (ii) termination of this Agreement by the Nodal Agency as mentioned under Article 3.3.4 of this Agreement.
- 6.5.2 The release of the Contract Performance Guarantee shall be without prejudice to other rights of the Nodal Agency under this Agreement.

Central Transmission Utility of India Limited

37

Bikaner A Power Transmission Limited

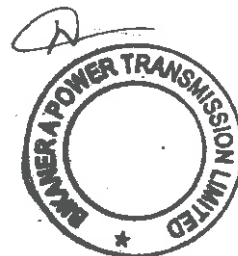
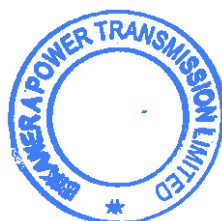

102

ARTICLE: 7

7 OPERATION AND MAINTENANCE OF THE PROJECT

7.1 Operation and Maintenance of the Project:

The TSP shall be responsible for ensuring that the Project is operated and maintained in accordance with the regulations made by the Commission and CEA from time to time and provisions of the Act.

Central Transmission Utility of India Limited

38

Bikaner A Power Transmission Limited

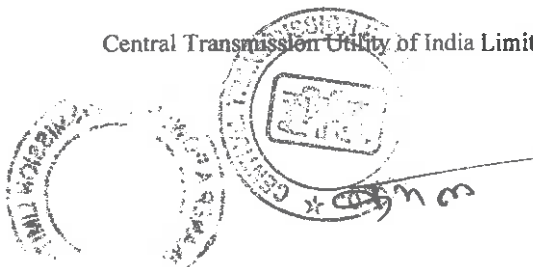

Handwritten initials

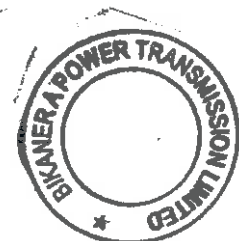

103

ARTICLE: 8

8 AVAILABILITY OF THE PROJECT

8.1 Calculation of Availability of the Project:

Calculation of Availability for the Elements and for the Project, as the case may be, shall be as per Appendix –IV to Central Electricity Regulatory Commission (Terms and Conditions of Tariff) Regulations, 2024, as applicable on the Bid Deadline and as appended in Schedule 6 of this Agreement.

8.2 Target Availability:

The Target Availability of each Element and the Project shall be 98%.

Payment of monthly Transmission charges based on actual availability will be calculated as per para 1.2 of Schedule 4 of this Agreement.

If the availability of any Element or the Project is below the Target Availability, for six consecutive months in a Contract Year, the DIC(s) or the Nodal Agency may issue a show cause notice to the TSP, asking them to show cause as to why the Transmission Service Agreement be not terminated. and if no satisfactory cause is shown it may terminate the Agreement. If the Nodal Agency is of the opinion that the transmission system is of critical importance, it may carry out or cause to carry the operation and maintenance of transmission system at the risk and cost of TSP.

Central Transmission Utility of India Limited

39

Bikaner A Power Transmission Limited

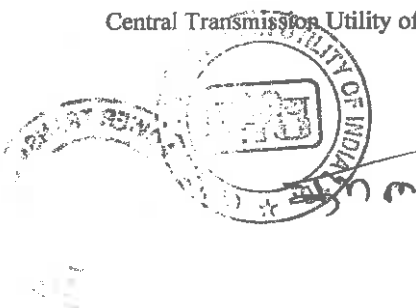

109

ARTICLE: 9

9 INSURANCES

9.1 Insurance:

9.1.1 The TSP shall effect and maintain or cause to be effected and maintained during the Construction Period and the Operating Period, adequate Insurances against such risks, with such deductibles including but not limited to any third party liability and endorsements and co-beneficiary/insured, as may be necessary under

- a. any of the Financing Agreements,
- b. the Laws, and
- c. in accordance with Prudent Utility Practices.

The Insurances shall be taken effective from a date prior to the date of the Financial Closure till the Expiry Date.

9.2 Evidence of Insurance cover:

9.2.1 The TSP shall furnish to the Nodal Agency copies of certificates and policies of the Insurances, as and when the Nodal Agency may seek from the TSP as per the terms of Article 9.1

9.3 Application of Insurance Proceeds:

9.3.1 Save as expressly provided in this Agreement, the policies of Insurances and the Financing Agreements, the proceeds of any insurance claim made due to loss or damage to the Project or any part of the Project shall be first applied to reinstatement, replacement or renewal of such loss or damage.

9.3.2 If a Natural Force Majeure Event renders the Project no longer economically and technically viable and the insurers under the Insurances make payment on a "total loss" or equivalent basis, the portion of the proceeds of such Insurance available to the TSP (after making admissible payments to the Lenders as per the Financing Agreements) shall be allocated only to the TSP. Nodal Agency and / or concerned Designated ISTS Customers shall have no claim on such proceeds of the Insurance.

9.3.3 Subject to the requirements of the Lenders under the Financing Agreements, any

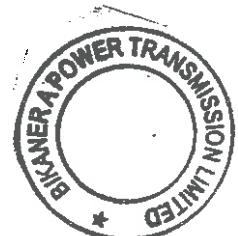

dispute or difference between the Parties as to whether the Project is no longer economically and technically viable due to a Force Majeure Event or whether that event was adequately covered in accordance with this Agreement by the Insurances shall be determined in accordance with Article 16.

9.4 Effect on liability of the Nodal Agency / Designated ISTS Customers

9.4.1 The Nodal Agency and / or the Designated ISTS Customers shall have no financial obligations or liability whatsoever towards the TSP in respect of this Article 9.

Central Transmission Utility of India Limited

41 Bikaner A Power Transmission Limited

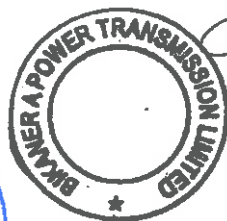
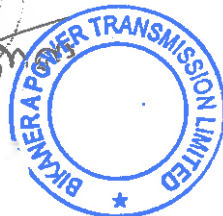
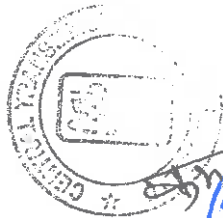

106

ARTICLE: 10

10 BILLING AND PAYMENT OF TRANSMISSION CHARGES

10.1 Subject to provisions of this Article 10, the Monthly Transmission Charges shall be paid to the TSP, in Indian Rupees, on monthly basis as per the provisions of the Sharing Regulations, from the date on which an Element(s) has achieved COD until the Expiry Date of this Agreement, unless terminated earlier and in line with the provisions of Schedule 4 of this Agreement.

10.2 Calculation of Monthly Transmission Charges:

The Monthly Transmission Charges for each Contract Year including Incentive & Penalty payment shall be calculated in accordance with the provisions of Schedule 4 of this Agreement.

10.3 Rebate & Late Payment Surcharge:

The rebate and late payment surcharge shall be governed as per Sharing Regulations.

10.4 Disputed Bills, Default in payment by the Designated ISTS Customers & Annual Reconciliation:

Any Disputed Bill, Default in payment by the Designated ISTS Customers & Annual Reconciliation shall be governed as per Sharing Regulations.

Central Transmission Utility of India Limited

42

Bikaner A Power Transmission Limited

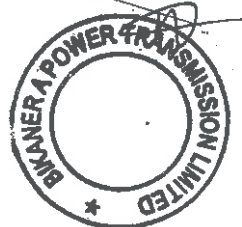
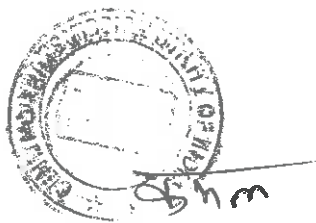

107

ARTICLE: 11

11 FORCE MAJEURE

11.1 Definitions

11.1.1 The following terms shall have the meanings given hereunder.

11.2 Affected Party

11.2.1 An Affected Party means any Party whose performance has been affected by an event of Force Majeure.

11.2.2 Any event of Force Majeure shall be deemed to be an event of Force Majeure affecting the TSP only if the Force Majeure event affects and results in, late delivery of machinery and equipment for the Project or construction, completion, commissioning of the Project by Scheduled COD and/or operation thereafter;

11.3 Force Majeure

A 'Force Majeure' means any event or circumstance or combination of events and circumstances including those stated below that wholly or partly prevents or unavoidably delays an Affected Party in the performance of its obligations/ roles under this Agreement, but only if and to the extent that such events or circumstances are not within the reasonable control, directly or indirectly, of the Affected Party and could not have been avoided if the Affected Party had taken reasonable care or complied with Prudent Utility Practices:

(a) Natural Force Majeure Events:

- i. act of God, including, but not limited to drought, fire and explosion (to the extent originating from a source external to the Site), earthquake, volcanic eruption, landslide, flood, cyclone, typhoon, tornado, or exceptionally adverse weather conditions, which are in excess of the statistical measures for the last hundred (100) years; and
- ii. epidemic/ pandemic notified by Indian Governmental Instrumentality.

(b) Non-Natural Force Majeure Events :

i. Direct Non-Natural Force Majeure Events

- Nationalization or compulsory acquisition by any Indian

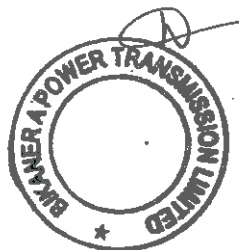
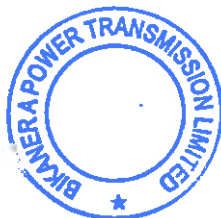

Governmental Instrumentality of any material assets or rights of the Affected Party; or

- the unlawful, unreasonable or discriminatory revocation of, or refusal to renew, any Consents, Clearances and Permits required by the Affected Party to perform their obligations/ roles under the RFP Project Documents or any unlawful, unreasonable or discriminatory refusal to grant any other Consents, Clearances and Permits required for the development/ operation of the Project, provided that a Competent Court of Law declares the revocation or refusal to be unlawful, unreasonable and discriminatory and strikes the same down; or
- any other unlawful, unreasonable or discriminatory action on the part of an Indian Governmental Instrumentality which is directed against the Project, provided that a Competent Court of Law declares the action to be unlawful, unreasonable and discriminatory and strikes the same down.

ii. Indirect Non - Natural Force Majeure Events

- act of war (whether declared or undeclared), invasion, armed conflict or act of foreign enemy, blockade, embargo, revolution, riot, insurrection, terrorist or military action; or
- radio active contamination or ionising radiation originating from a source in India or resulting from any other Indirect Non Natural Force Majeure Event mentioned above, excluding circumstances where the source or cause of contamination or radiation is brought or has been brought into or near the Site by the Affected Party or those employed or engaged by the Affected Party; or
- industry-wide strikes and labour disturbances, having a nationwide impact in India.

11.4 Force Majeure Exclusions

11.4.1 Force Majeure shall not include (i) any event or circumstance which is within the reasonable control of the Parties and (ii) the following conditions, except to the extent that they are consequences of an event of Force Majeure:

(a) Unavailability, late delivery, or changes in cost of the machinery, equipment,

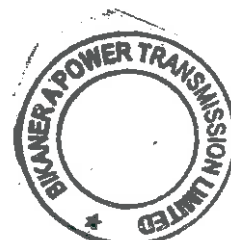
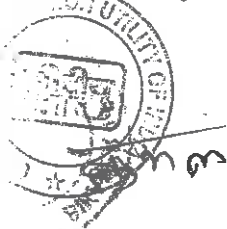

materials, spare parts etc. for the Project;

- (b) Delay in the performance of any Contractors or their agents;
- (c) Non-performance resulting from normal wear and tear typically experienced in transmission materials and equipment;
- (d) Strikes or labour disturbance at the facilities of the Affected Party;
- (e) Insufficiency of finances or funds or the Agreement becoming onerous to perform; and
- (f) Non-performance caused by, or connected with, the Affected Party's:
 - i. negligent or intentional acts, errors or omissions;
 - ii. failure to comply with an Indian Law; or
 - iii. breach of, or default under this Agreement or any Project Documents.
- (g) Any error or omission in the survey report provided by BPC during the bidding process.

11.5 Notification of Force Majeure Event

11.5.1 The Affected Party shall give notice to the other Party of any event of Force Majeure as soon as reasonably practicable, but not later than seven (7) days after the date on which such Party knew or should reasonably have known of the commencement of the event of Force Majeure. If an event of Force Majeure results in a breakdown of communications rendering it unreasonable to give notice within the applicable time limit specified herein, then the Party claiming Force Majeure shall give such notice as soon as reasonably practicable after reinstatement of communications, but not later than one (1) day after such reinstatement.

Provided that, such notice shall be a pre-condition to the Affected Party's entitlement to claim relief under this Agreement. Such notice shall include full particulars of the event of Force Majeure, its effects on the Party claiming relief and the remedial measures proposed. The Affected Party shall give the other Party regular reports on the progress of those remedial measures and such other information as the other Party may reasonably request about the Force Majeure.

11.5.2 The Affected Party shall give notice to the other Party of (i) the cessation of the

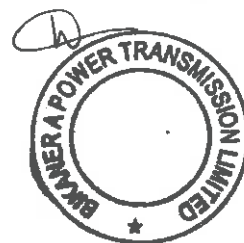

relevant event of Force Majeure; and (ii) the cessation of the effects of such event of Force Majeure on the performance of its rights or obligations/ roles under this Agreement, as soon as practicable after becoming aware of each of these cessations.

11.6 Duty to perform and duty to mitigate

To the extent not prevented by a Force Majeure Event, the Affected Party shall continue to perform its obligations/ roles as provided in this Agreement. The Affected Party shall use its reasonable efforts to mitigate the effect of any event of Force Majeure as soon as practicable.

11.7 Available Relief for a Force Majeure Event

Subject to this Article 11,

- (a) no Party shall be in breach of its obligations/ roles pursuant to this Agreement to the extent that the performance of its obligations/ roles was prevented, hindered or delayed due to a Force Majeure Event;
- (b) each Party shall be entitled to claim relief for a Force Majeure Event affecting its performance in relation to its obligations/ roles under Articles 3.3.4, 4.4.2 and 6.3.1 of this Agreement.
- (c) For the avoidance of doubt, it is clarified that the computation of Availability of the Element(s) under outage due to Force Majeure Event, as per Article 11.3 affecting the TSP shall be as per Appendix –IV to Central Electricity Regulatory Commission (Terms and Conditions of Tariff) Regulations, 2024 as on Bid Deadline. For the event(s) for which the Element(s) is/are deemed to be available as per Appendix –IV to Central Electricity Regulatory Commission (Terms and Conditions of Tariff) Regulations, 2024, then the Transmission Charges, as applicable to such Element(s), shall be payable as per Schedule 4, for the duration of such event(s).
- (d) For so long as the TSP is claiming relief due to any Force Majeure Event under this Agreement, the Nodal Agency may, if it so desires, from time to time on one (1) day notice, inspect the Project and the TSP shall provide the Nodal Agency's personnel with access to the Project to carry out such inspections.
- (e) For avoidance of doubt, the TSP acknowledges that for extension of Scheduled COD a period up to one hundred eighty (180) days due to Force Majeure event, no compensation on the grounds such as interest cost, incident

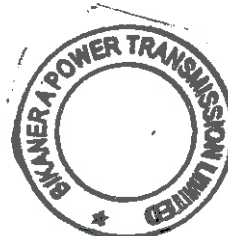

111

expenditure. opportunity cost will be made to the TSP. However, if Scheduled COD is extended beyond a period of one hundred eighty (180) days due to Force Majeure event, the TSP will be allowed to recover the interest cost during construction corresponding to the period exceeding one hundred eighty (180) days by adjustment in the Transmission Charges in accordance with Schedule 9.

Central Transmission Utility of India Limited

47

Bikaner A Power Transmission Limited

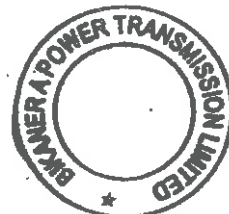

112

ARTICLE: 12

12 CHANGE IN LAW

12.1 Change in Law

12.1.1 Change in Law means the occurrence of any of the following after the Bid Deadline resulting into any additional recurring / non-recurring expenditure by the TSP or any savings of the TSP:

- the enactment, coming into effect, adoption, promulgation, amendment, modification or repeal (without re-enactment or consolidation) in India, of any Law, including rules and regulations framed pursuant to such Law, subject to the provisions under Article 12.1.2;
- a change in the interpretation or application of any Law by any Indian Governmental Instrumentality having the legal power to interpret or apply such Law, or any Competent Court of Law;
- the imposition of a requirement for obtaining any Consents, Clearances and Permits which was not required earlier;
- a change in the terms and conditions prescribed for obtaining any Consents, Clearances and Permits or the inclusion of any new terms or conditions for obtaining such Consents, Clearances and Permits;
- any change in the licensing regulations of the Commission, under which the Transmission License for the Project was granted if made applicable by such Commission to the TSP;
- change in wind zone; or
- any change in tax or introduction of any tax made applicable for providing Transmission Service by the TSP as per the terms of this Agreement.

12.1.2 Notwithstanding anything contained in this Agreement, Change in Law shall not cover any change:

- a) Taxes on corporate income; and
- b) Withholding tax on income or dividends distributed to the shareholders of the TSP.

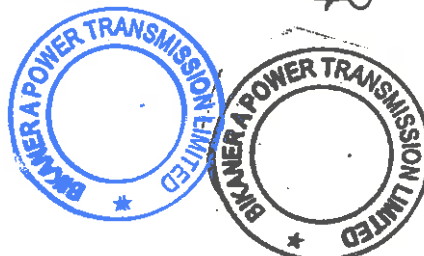
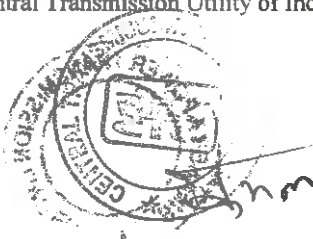

12.2 Relief for Change in Law

12.2.1 During Construction Period, the impact of increase/decrease in the cost of the Project on the Transmission Charges shall be governed by the formula given in Schedule 9 of this Agreement.

12.2.2 During the Operation Period:

During the operation period, if as a result of Change in Law, the TSP suffers or is benefited from a change in costs or revenue, the aggregate financial effect of which exceeds 0.30% (zero point three percent) of the Annual Transmission Charges in aggregate for a Contract Year, the TSP may notify so to the Nodal Agency and propose amendments to this Agreement so as to place the TSP in the same financial position as it would have enjoyed had there been no such Change in Law resulting in change in costs or revenue as aforesaid.

12.2.3 For any claims made under Articles 12.2.1 and 12.2.2 above, the TSP shall provide to the Nodal Agency documentary proof of such increase / decrease in cost of the Project / revenue for establishing the impact of such Change in Law.

In cases where Change in Law results in decrease of cost and it comes to the notice of Nodal Agency that TSP has not informed Nodal Agency about such decrease in cost, Nodal Agency may initiate appropriate claim.

12.3 Notification of Change in Law:

12.3.1 If the TSP is affected by a Change in Law in accordance with Article 12.1 and wishes to claim relief for such Change in Law under this Article 12, it shall give notice to Nodal Agency of such Change in Law as soon as reasonably practicable after becoming aware of the same.

12.3.2 The TSP shall also be obliged to serve a notice to the Nodal Agency even when it is beneficially affected by a Change in Law.

12.3.3 Any notice served pursuant to Articles 12.3.1 and 12.3.2 shall provide, amongst other things, precise details of the Change in Law and its estimated impact on the TSP.

12.4 Payment on account of Change in Law

12.4.1 The payment for Change in Law shall be through a separate Bill. However, in case of any change in Monthly Transmission Charges by reason of Change in

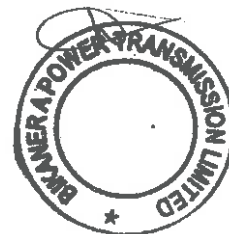
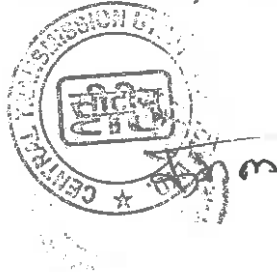

Law, as determined in accordance with this Agreement, the Bills to be raised by the Nodal Agency after such change in Transmission Charges shall appropriately reflect the changed Monthly Transmission Charges.

Central Transmission Utility of India Limited

50

Bikaner A Power Transmission Limited

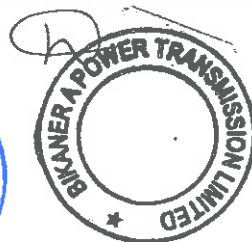
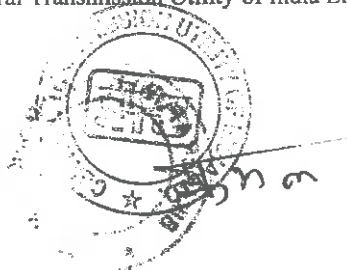

115

ARTICLE: 13

13 EVENTS OF DEFAULT AND TERMINATION

13.1 TSP's Event of Default

The occurrence and continuation of any of the following events shall constitute a TSP Event of Default, unless any such TSP Event of Default occurs as a result of any non-fulfilment of its obligations as prescribed under this Agreement by the Nodal Agency or a Force Majeure Event:

- a. After having taken up the construction of the Project, the abandonment by the TSP or the TSP's Contractors of the construction of the Project for a continuous period of two (2) months and such default is not rectified within thirty (30) days from the receipt of notice from the Nodal Agency in this regard;
- b. The failure to commission any Element of the Project by the date falling six (6) months after its Scheduled COD unless extended by Nodal Agency as per provisions of this Agreement;
- c. If the TSP:
 - i. assigns, mortgages or charges or purports to assign, mortgage or charge any of its assets or rights related to the Project in contravention of the provisions of this Agreement; or
 - ii. transfers or novates any of its obligations pursuant to this Agreement, in a manner contrary to the provisions of this Agreement;

Except where such transfer is in pursuance of a Law and

- it does not affect the ability of the transferee to perform, and such transferee has the financial and technical capability to perform, its obligations under this Agreement;
- is to a transferee who assumes such obligations under the Project and this Agreement remains effective with respect to the transferee;

- d. If:

Central Transmission Utility of India Limited

51

Bikaner A Power Transmission Limited

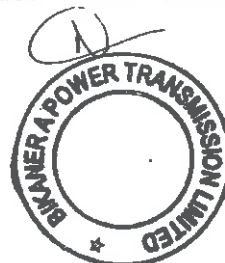
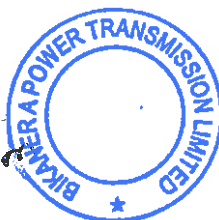

- i. The TSP becomes voluntarily or involuntarily the subject of any bankruptcy or insolvency or winding up proceedings and such proceedings remain uncontested for a period of thirty (30) days; or
- ii. any winding up or bankruptcy or insolvency order is passed against the TSP; or
- iii. the TSP goes into liquidation or dissolution or a receiver or any similar officer is appointed over all or substantially all of its assets or official liquidator is appointed to manage its affairs, pursuant to Law,

Provided that a dissolution or liquidation of the TSP will not be a TSP's Event of Default, where such dissolution or liquidation of the TSP is for the purpose of a merger, consolidation or reorganization with the prior approval of the Commission as per the provisions of Central Electricity Regulatory Commission (Procedure, terms and Conditions for grant of Transmission License and other related matters) Regulations, 2006 or as amended from time to time; or

- e. Failure on the part of the TSP to comply with the provisions of Article 19.1 of this Agreement; or
- f. the TSP repudiates this Agreement and does not rectify such breach even within a period of thirty (30) days from a notice from the Nodal Agency in this regard; or
- g. after Commercial Operation Date of the Project, the TSP fails to achieve monthly Target Availability of 98%, for a period of six (6) consecutive months or within a non-consecutive period of six (6) months within any continuous aggregate period of eighteen(18) months except where the Availability is affected by Force Majeure Events as per Article 11; or
- h. any of the representations and warranties made by the TSP in Article 17 of this Agreement being found to be untrue or inaccurate. Further, in addition to the above, any of the undertakings submitted by the Selected Bidder at the time of submission of the Bid being found to be breached or inaccurate, including but not limited to undertakings from its Parent Company / Affiliates related to the minimum equity obligation; or

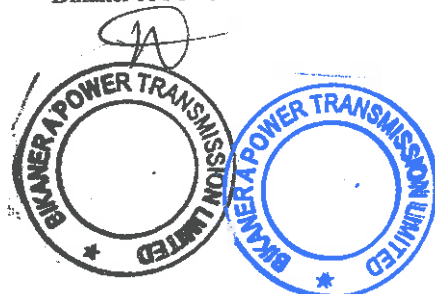

- i. the TSP fails to complete / fulfil all the activities / conditions within the specified period as per Article 3; or
- j. except for the reasons solely attributable to Nodal Agency, the TSP is in material breach of any of its obligations under this Agreement and such material breach is not rectified by the TSP within thirty (30) days of receipt of notice in this regard from the Nodal Agency; or
- k. the TSP fails to take the possession of the land required for location specific substations, switching stations or HVDC terminal or inverter stations and / or fails to pay the requisite price to the parties and / or any State Government authority from whom the land is acquired, within twelve (12) months from the Effective Date.

13.2 Termination Procedure for TSP Event of Default

- a. Upon the occurrence and continuance of any TSP's Event of Default under Article 13.1 the Nodal Agency may serve notice on the TSP, with a copy to the CEA and the Lenders' Representative, of their intention to terminate this Agreement (a "Nodal Agency's Preliminary Termination Notice"), which shall specify in reasonable detail, the circumstances giving rise to such Nodal Agency's Preliminary Termination Notice.
- b. Following the issue of a Nodal Agency's Preliminary Termination Notice, the Consultation Period shall apply and would be for the Parties to discuss as to what steps shall be taken with a view to mitigate the consequences of the relevant Event of Default having regard to all the circumstances.
- c. During the Consultation Period, the Parties shall, save as otherwise provided in this Agreement, continue to perform their respective obligations/ roles under this Agreement, and the TSP shall not remove any material, equipment or any part of the Project, without prior consent of the Nodal Agency.

Following the expiry of the Consultation Period, unless the Parties shall have otherwise agreed to the contrary or the circumstances giving rise to Nodal Agency's Preliminary Termination Notice shall have ceased to exist or shall have been remedied, this Agreement may be terminated by the Nodal Agency by giving a Termination Notice to the TSP, in writing, of at least seven (7) days, with a copy to CEA and the Lenders' Representative in order to enable the Lenders to exercise right of substitution in accordance with Article 15.3 of this Agreement.

Central Transmission Utility of India Limited

53

Bikaner A Power Transmission Limited

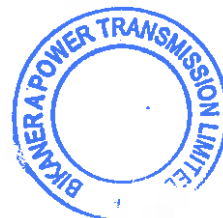
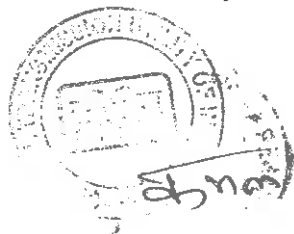

118

Further, the Nodal Agency may also initiate proceedings to blacklist the TSP & its Affiliates from participation in any RFP issued by BPCs for a period of 5 years.

13.3 Procedure for Nodal Agency's non-fulfilment of Role

- a. Upon the Nodal Agency not being able to fulfil its role under Article 4.2, the TSP may serve notice on the Nodal Agency, with a copy to CEA and the Lenders' Representative (a "TSP's Preliminary Notice"), which notice shall specify in reasonable detail the circumstances giving rise to such non-fulfilment of role by the Nodal Agency.
- b. Following the issue of a TSP's Preliminary Notice, the Consultation Period shall apply.
- c. The Consultation Period would be for the Parties to discuss as to what steps shall be taken with a view to mitigate the consequences of the relevant non-fulfilment of role by the Nodal Agency including giving time extension to TSP, having regard to all the circumstances.
- d. During the Consultation Period, both Parties shall, save as otherwise provided in this Agreement, continue to perform their respective obligations/ roles under this Agreement.

13.4 Termination due to Force Majeure

- 13.4.1 In case the Parties could not reach an agreement pursuant to Articles 3.3.4 and 4.4.2 of this Agreement and the Force Majeure Event or its effects continue to be present, the Nodal Agency shall have the right to cause termination of the Agreement. In case of such termination, the Contract Performance Guarantee shall be returned to the TSP as per the provisions of Article 6.5.1.
- 13.4.2 In case of termination of this Agreement, the TSP shall provide to the Nodal Agency the full names and addresses of its Contractors as well as complete designs, design drawings, manufacturing drawings, material specifications and

Central Transmission Utility of India Limited

54

Bikaner A Power Transmission Limited

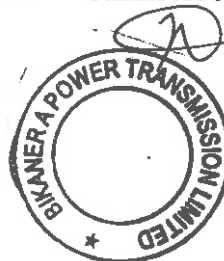

technical information, as required by the Nodal Agency within thirty (30) days of Termination Notice.

13.5 Termination or amendment due to non-requirement of any Element or Project during construction

13.5.1 In case any Element or Project, which is under construction, is no longer required due to any reason whatsoever, the Nodal Agency may issue a notice to this effect to the TSP.

13.5.2 Nodal agency may also issue notice to the TSP seeking their response to the proposed termination/ amendment (as the case may be) of the Agreement. The Nodal Agency shall issue copy of such notice to Lenders. In the notice, Nodal Agency shall also include an assessment of the physical progress made by TSP in the Element/ Project (as the case may be) that is no longer required.

13.5.3 The TSP shall neither carry out further investment nor carry out any work on the Element/ Project (as the case may be) that is no longer required after delivery of the notice.

13.5.4 After taking into account the comments of the TSP, the Nodal Agency may terminate the Agreement or amend it if both Parties agree to the amendment.

13.6 Revocation of the Transmission License

13.6.1 The Commission may, as per the provisions of the Electricity Act, 2003, revoke the Transmission License of the ISTS Licensee. Further, in such a case, the Agreement shall be deemed to have been terminated.

13.7 Termination Payment

13.7.1 If Agreement is terminated on account of Force Majeure Events, non-requirement of any Element or Project during Construction, Nodal Agency's non-fulfilment of Role & TSP's Event of Default, the TSP shall be entitled for Termination Payment equivalent to valuation of Project Assets. Upon payment, the Nodal Agency shall take over the Project Assets.

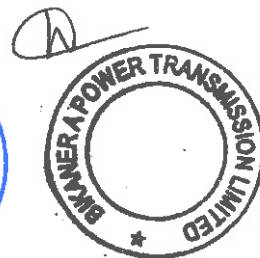
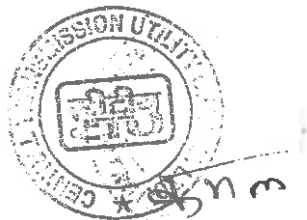

ARTICLE: 14

14 LIABILITY AND INDEMNIFICATION

14.1 Indemnity

14.1.1 The TSP shall indemnify, defend and hold the Nodal Agency harmless against:

(a) any and all third party claims, actions, suits or proceedings against the Nodal Agency for any loss of or damage to property of such third party, or death or injury to such third party, arising out of a breach by the TSP of any of its obligations under this Agreement, except to the extent that any such claim, action, suit or proceeding has arisen due to a negligent act or omission, breach of this Agreement or non-fulfilment of statutory duty on the part of Nodal Agency; and

(b) any and all losses, damages, costs and expenses including legal costs, fines, penalties and interest actually suffered or incurred by the Nodal Agency from third party claims arising by reason of:

i. a breach by the TSP of any of its obligations under this Agreement, (provided that this Article 14 shall not apply to such breaches by the TSP, for which specific remedies have been provided for under this Agreement) except to the extent that any such losses, damages, costs and expenses including legal costs, fines, penalties and interest (together to constitute "Indemnifiable Losses") has arisen due to a negligent act or omission, breach of this Agreement or non-fulfilment of statutory duty on the part of the Nodal Agency, or

ii. any of the representations and warranties of the TSP under this Agreement being found to be inaccurate or untrue.

14.1.2 The Nodal Agency shall, in accordance with the Regulations framed by CERC in this regard, indemnify, defend and hold the TSP harmless against:

(a) any and all third party claims, actions, suits or proceedings against the TSP, for any loss of or damage to property of such third party, or death or injury to such third party, arising out of any material breach by the Nodal Agency of any of their roles under this Agreement, except to the extent that any such claim, action, suit or proceeding has arisen due to a negligent act or omission, breach of this Agreement or breach of statutory duty on the part of the TSP, its Contractors, servants or agents; and

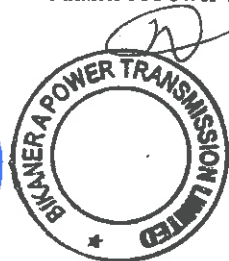
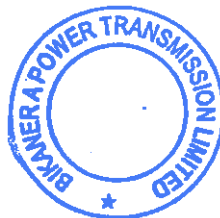

- (b) any and all losses, damages, costs and expenses including legal costs, fines, penalties and interest ('Indemnifiable Losses') actually suffered or incurred by the TSP from third party claims arising by reason of:
- i. any material breach by the Nodal Agency of any of its roles under this Agreement (provided that, this Article 14 shall not apply to such breaches by the Nodal Agency, for which specific remedies have been provided for under this Agreement), except to the extent that any such Indemnifiable Losses have arisen due to a negligent act or omission, breach of this Agreement or breach of statutory duty on the part of the TSP, its Contractors, servants or agents or
 - ii. any of the representations and warranties of the Nodal Agency under this Agreement being found to be inaccurate or untrue.

14.2 Patent Indemnity:

14.2.1

- (a) The TSP shall, subject to the Nodal Agency's compliance with Article 14.2.1 (b), indemnify and hold harmless the Nodal Agency and its employees and officers from and against any and all suits, actions or administrative proceedings, claims, demands, losses, damages, costs, and expenses of whatsoever nature, including attorney's fees and expenses, which the Nodal Agency may suffer as a result of any infringement or alleged infringement of any patent, utility model, registered design, trademark, copyright or other intellectual property right registered or otherwise existing at the date of the Agreement by reason of the setting up of the Project by the TSP.

Such indemnity shall not cover any use of the Project or any part thereof other than for the purpose indicated by or to be reasonably inferred from the Agreement, any infringement resulting from the misuse of the Project or any part thereof, or any products produced in association or combination with any other equipment, plant or materials not supplied by the TSP, pursuant to the Agreement.

- (b) If any proceedings are brought or any claim is made against the Nodal Agency arising out of the matters referred to in Article 14.2.1(a), the Nodal Agency shall promptly give the TSP a notice thereof, and the TSP shall at its own expense take necessary steps and attend such proceedings or claim and any negotiations for the settlement of any such proceedings or claim.

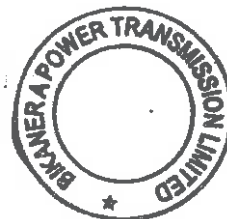
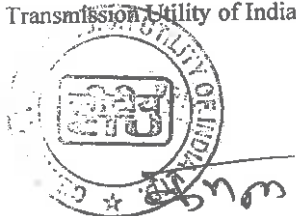

The TSP shall promptly notify the Nodal Agency of all actions taken in such proceedings or claims.

- (c) If the TSP fails to notify the Nodal Agency within twenty-eight (28) days after receipt of such notice from the Nodal Agency under Article 14.2.1(b) above, that it intends to attend any such proceedings or claim, then the Nodal Agency shall be free to attend the same on their own behalf at the cost of the TSP. Unless the TSP has so failed to notify the Nodal Agency within the twenty eight (28) days period, the Nodal Agency shall make no admission that may be prejudicial to the defence of any such proceedings or claims.
- (d) The Nodal Agency shall, at the TSP's request, afford all available assistance to the TSP in attending to such proceedings or claim, and shall be reimbursed by the TSP for all reasonable expenses incurred in so doing.

14.2.2

- (a) The Nodal Agency, in accordance with the Regulations framed by CERC in this regard, subject to the TSP's compliance with Article 14.2.2(b) shall indemnify and hold harmless the TSP and its employees, officers from and against any and all suits, actions or administrative proceedings, claims, demands, losses, damages, costs and expenses of whatsoever nature, including attorney's fees and expenses, which the TSP may suffer as a result of any infringement or alleged infringement of any patent, utility model, registered design, trademark, copyright or other intellectual property right registered or otherwise existing at the date of the Agreement by reason of the setting up of the Project by the TSP.
- (b) If any proceedings are brought or any claim is made against the TSP arising out of the matters referred to in Article 14.2.2 (a) the TSP shall promptly give the Nodal Agency a notice thereof, and the Nodal Agency shall at its own expense take necessary steps and attend such proceedings or claim and any negotiations for the settlement of any such proceedings or claim. The Nodal Agency shall promptly notify the TSP of all actions taken in such proceedings or claims.
- (c) If the Nodal Agency fails to notify the TSP within twenty-eight (28) days after receipt of such notice from the TSP under Article 14.2.2(b) above, that it intends to attend any such proceedings or claim, then the TSP shall be free to attend the same on its own behalf at the cost of the Nodal Agency. Unless the Nodal Agency has so failed to notify the TSP within the twenty (28) days period, the TSP shall make no admission that may be prejudicial to the

Central Transmission Utility of India Limited

58

Bikaner A Power Transmission Limited

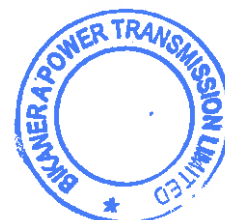
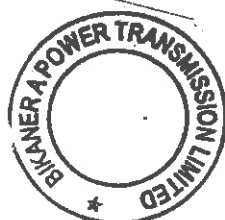

123

defence of any such proceedings or claim.

- (d) The TSP shall, at the Nodal Agency request, afford all available assistance to the Nodal Agency in attending to such proceedings or claim, and shall be reimbursed by the Nodal Agency for all reasonable expenses incurred in so doing.

14.3 Monetary Limitation of liability

- 14.3.1 A Party ("Indemnifying Party") shall be liable to indemnify the other Party ("Indemnified Party") under this Article 14 for any indemnity claims made in a Contract Year only up to an amount of Rupees Ten Crore Fifty Lakh Only (Rs. 10.50 Crore).

14.4 Procedure for claiming indemnity

- 14.4.1 Where the Indemnified Party is entitled to indemnification from the Indemnifying Party pursuant to Articles 14.1 or 14.2 the Indemnified Party shall promptly notify the Indemnifying Party of such claim, proceeding, action or suit referred to in Articles 14.1 or 14.2 in respect of which it is entitled to be indemnified. Such notice shall be given as soon as reasonably practicable after the Indemnified Party becomes aware of such claim, proceeding, action or suit. The Indemnifying Party shall be liable to settle the indemnification claim within thirty (30) days of receipt of the above notice.

Provided however that, if:

- i. the Parties choose to contest, defend or litigate such claim, action, suit or proceedings in accordance with Article 14.4.3 below; and
- ii. the claim amount is not required to be paid/deposited to such third party pending the resolution of the Dispute,

the Indemnifying Party shall become liable to pay the claim amount to the Indemnified Party or to the third party, as the case may be, promptly following the resolution of the Dispute, if such Dispute is not settled in favour of the Indemnified Party.

- 14.4.2 The Indemnified Party may contest, defend and litigate a claim, action, suit or proceeding for which it is entitled to be indemnified under Articles 14.1 or 14.2 and the Indemnifying Party shall reimburse to the Indemnified Party all reasonable costs and expenses incurred by the Indemnified Party. However, such Indemnified Party shall not settle or compromise such claim, action, suit or

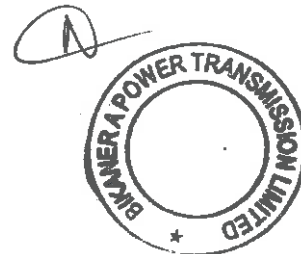
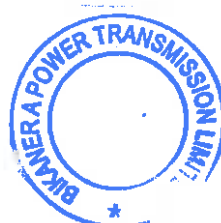
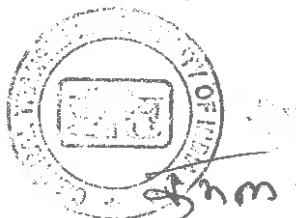

proceedings without first getting the consent of the Indemnifying Party, which consent shall not be unreasonably withheld or delayed.

- 14.4.3 An Indemnifying Party may, at its own expense, assume control of the defence of any proceedings brought against the Indemnified Party if it acknowledges its obligation to indemnify such Indemnified Party, gives such Indemnified Party prompt notice of its intention to assume control of the defence, and employs an independent legal counsel at its own cost that is reasonably satisfactory to the Indemnified Party.

14.5 Limitation on Liability

- 14.5.1 Except as expressly provided in this Agreement, neither the TSP nor the Nodal Agency nor their respective officers, directors, agents, employees or Affiliates (including, officers, directors, agents or employees of such Affiliates), shall be liable or responsible to the other Party or its Affiliates including its officers, directors, agents, employees, successors, insurers or permitted assigns for incidental, indirect or consequential, punitive or exemplary damages, connected with or resulting from performance or non-performance of this Agreement, or anything done in connection herewith, including claims in the nature of lost revenues, income or profits (other than payments expressly required and properly due under this Agreement), any increased expense of, reduction in or loss of transmission capacity or equipment used therefore, irrespective of whether such claims are based upon breach of warranty, tort (including negligence, whether of the Nodal Agency, the TSP or others), strict liability, contract, breach of statutory duty, operation of law or otherwise.

- 14.5.2 The Nodal Agency shall have no recourse against any officer, director or shareholder of the TSP or any Affiliate of the TSP or any of its officers, directors or shareholders for such claims excluded under this Article. The TSP shall also have no recourse against any officer, director or shareholder of the Nodal Agency, or any Affiliate of the Nodal Agency or any of its officers, directors or shareholders for such claims excluded under this Article.

14.6 Duty to Mitigate

The party entitled to the benefit of an indemnity under this Article 14 shall take all reasonable measures to mitigate any loss or damage which has occurred. If the Party fails to take such measures, the other Party's liabilities shall be correspondingly reduced.

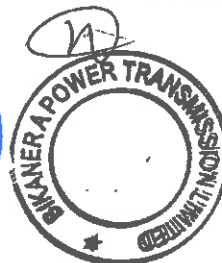
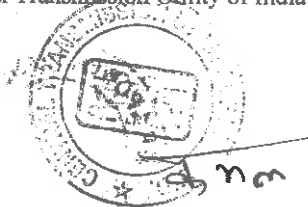

ARTICLE: 15

15 ASSIGNMENTS AND CHARGES

15.1 Assignments:

15.1.1 This Agreement shall be binding upon, and inure to the benefit of the Parties and their respective successors and permitted assigns. This Agreement shall not be assigned by any Party, except as provided in Article 15.3.

15.2 Permitted Charges:

15.2.1 Neither Party shall create or permit to subsist any encumbrance over all or any of its rights and benefits under this Agreement.

15.2.2 However, the TSP may create any encumbrance over all or part of the receivables, or the Project Assets of the Project in favour of the Lenders or the Lenders' Representative on their behalf, as security for amounts payable under the Financing Agreements and any other amounts agreed by the Parties.

Provided that:

- i. the Lenders or the Lenders' Representative on their behalf shall have entered into the Financing Agreements and agreed in writing to the provisions of this Agreement; and
- ii. any encumbrance granted by the TSP in accordance with this Article 15.2.2 shall contain provisions pursuant to which the Lenders or the Lender's Representative on their behalf agrees unconditionally with the TSP to release from such encumbrances upon payment by the TSP to the Lenders of all amounts due under the Financing Agreements.

15.2.3 Article 15.2.1 does not apply to:

- a. liens arising by operation of law (or by an agreement evidencing the same) in the ordinary course of the TSP developing and operating the Project;
- b. pledges of goods, the related documents of title and / or other related documents, arising or created in the ordinary course of the TSP developing and operating the Project; or
- c. security arising out of retention of title provisions in relation to goods acquired in the ordinary course of the TSP developing and operating the Project.

Central Transmission Utility of India Limited

61

Bikaner A Power Transmission Limited

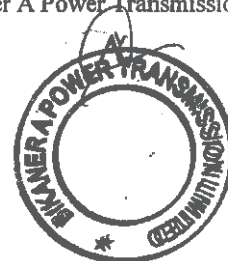
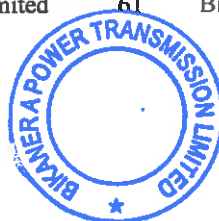
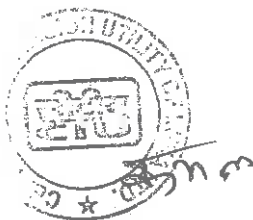

126

15.3 Substitution Rights of the Lenders

15.3.1 The TSP would need to operate and maintain the Project under the provisions of this Agreement and cannot assign the Transmission License or transfer the Project or part thereof to any person by sale, lease, exchange or otherwise, without the prior approval of the Nodal Agency.

15.3.2 However, in the case of default by the TSP in debt repayments or in the case of default by the TSP as per Article 13 of this Agreement during the debt repayments, the Commission may, on an application from the Lenders, assign the Transmission License to the nominee of the Lenders subject to the fulfilment of the qualification requirements and provisions of the Central Electricity Regulatory Commission (Procedure, terms and Conditions for grant of Transmission License and other related matters) Regulations, 2006 and as amended from time to time.

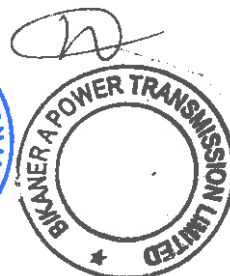

ARTICLE: 16

16 GOVERNING LAW AND DISPUTE RESOLUTION

16.1 Governing Law:

This Agreement shall be governed by and construed in accordance with the Laws of India. Any legal proceedings in respect of any matters, claims or disputes under this Agreement shall be under the jurisdiction of appropriate courts in Delhi.

16.2 Amicable Settlement:

16.2.1 Either Party is entitled to raise any claim, dispute or difference of whatever nature arising under, out of or in connection with this Agreement, including its existence or validity or termination or whether during the execution of the Project or after its completion and whether prior to or after the abandonment of the Project or termination or breach of the Agreement by giving a written notice to the other Party, which shall contain:

- (i) a description of the Dispute;
- (ii) the grounds for such Dispute; and
- (iii) all written material in support of its claim.

16.2.2 The other Party shall, within thirty (30) days of issue of notice issued under Article 16.2.1, furnish:

- (i) counter-claim and defences, if any, regarding the Dispute; and
- (ii) all written material in support of its defences and counter-claim.

16.2.3 Within thirty (30) days of issue of notice by the Party pursuant to Article 16.2.1, if the other Party does not furnish any counter claim or defense under Article 16.2.2, or thirty (30) days from the date of furnishing counter claims or defence by the other Party, both the Parties to the Dispute shall meet to settle such Dispute amicably. If the Parties fail to resolve the Dispute amicably within thirty (30) days from the later of the dates mentioned in this Article 16.2.3, the Dispute shall be referred for dispute resolution in accordance with Article 16.3.

16.3 Dispute Resolution:

All Disputes shall be adjudicated by the Commission.

16.4 Parties to Perform Obligations:

Central Transmission Utility of India Limited

63

Bikaner A Power Transmission Limited

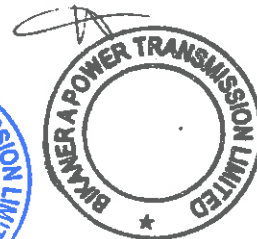
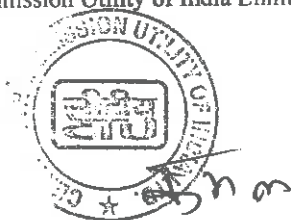

128

Notwithstanding the existence of any Dispute and difference referred to the Commission as provided in Article 16.3 and save as the Commission may otherwise direct by a final or interim order, the Parties hereto shall continue to perform their respective obligations/ roles (which are not in dispute) under this Agreement.

Central Transmission Utility of India Limited

64

Bikaner A Power Transmission Limited

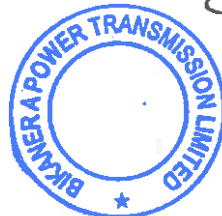
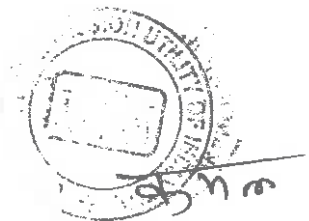

Handwritten signature

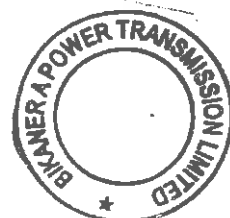

Handwritten number 127

ARTICLE: 17

17 REPRESENTATION AND WARRANTIES

17.1 Representation and warranties of the Nodal Agency

17.1.1 The Nodal Agency hereby represents and warrants to and agrees with the TSP as follows and acknowledges and confirms that the TSP is relying on such representations and warranties in connection with the transactions described in this Agreement:

- a. It has all requisite powers and authority to execute and consummate this Agreement;
- b. This Agreement is enforceable against the Nodal Agency in accordance with its terms;
- c. The consummation of the transactions contemplated by this Agreement on the part of Nodal Agency will not violate any provision of nor constitute a default under, nor give rise to a power to cancel any charter, mortgage, deed of trust or lien, lease, agreement, license, permit, evidence of indebtedness, restriction, or other contract to which the Nodal Agency is a Party or to which the Nodal Agency is bound, which violation, default or power has not been waived;

17.2 Representation and Warranties of the TSP:

17.2.1 The TSP hereby represents and warrants to and agrees with the Nodal Agency as follows and acknowledges and confirms that the Nodal Agency is relying on such representations and warranties in connection with the transactions described in this Agreement:

- a. It has all requisite powers and has been duly authorized to execute and consummate this Agreement;
- b. This Agreement is enforceable against it, in accordance with its terms;
- c. The consummation of the transactions contemplated by this Agreement on the part of the TSP will not violate any provision of nor constitute a default under, nor give rise to a power to cancel any charter, mortgage, deed of trust or lien, lease, agreement, license, permit, evidence of indebtedness, restriction, or other contract to which the TSP is a Party or to which the TSP is bound which violation, default or power has not been waived;
- d. The TSP is not insolvent and no insolvency proceedings have been instituted, nor threatened or pending by or against the TSP;

Central Transmission Utility of India Limited

65

Bikaner A Power Transmission Limited

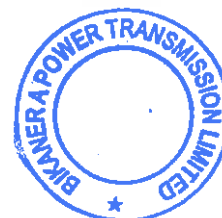
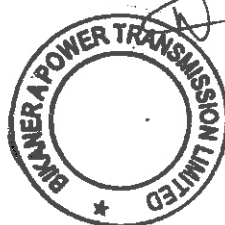
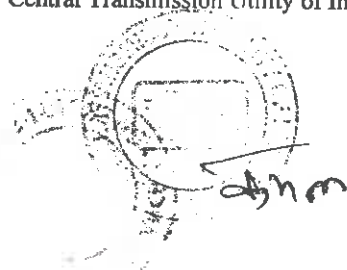

180

- e. There are no actions, suits, claims, proceedings or investigations pending or, to the best of the TSP's knowledge, threatened in writing against the TSP at law, in equity, or otherwise, and whether civil or criminal in nature, before or by, any court, commission, arbitrator or governmental agency or authority, and there are no outstanding judgments, decrees or orders of any such courts, commission, arbitrator or governmental agencies or authorities, which materially adversely affect its ability to execute the Project or to comply with its obligations under this Agreement.

17.2.2 The TSP makes all the representations and warranties above to be valid as on the Effective Date of this Agreement.

Central Transmission Utility of India Limited

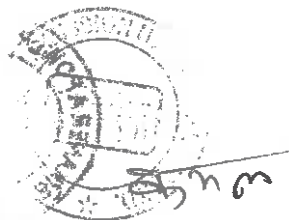

66

Bikaner A Power Transmission Limited

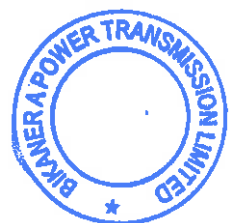
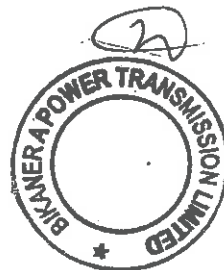

131

ARTICLE: 18

18 INDEPENDENT ENGINEER

18.1 Appointment of Independent Engineer

The Nodal Agency shall appoint an agency/ company as Independent Engineer as per framework provided in the Guidelines for Encouraging Competition in Development of Transmission Projects for selection of Independent Engineer.

18.2 Roles and functions of Independent Engineer

The role and functions of the Independent Engineer shall include the following:

- a. Progress Monitoring as required under this Agreement;
- b. Ensuring Quality as required under this Agreement;
- c. determining, as required under the Agreement, the costs of any works or services and/or their reasonableness during construction phase;
- d. determining, as required under the Agreement, the period or any extension thereof, for performing any duty or obligation during construction phase;
- e. determining, as required under the Agreement, the valuation of the Project Assets.
- f. Assisting the Parties in resolution of Disputes and
- g. Undertaking all other duties and functions in accordance with the Agreement.

18.3 Remuneration of Independent Engineer

The fee and charges of the Independent Engineer shall be paid by the Nodal Agency as per terms & conditions of appointment.

18.4 Termination of appointment

18.4.1 The Nodal Agency may, in its discretion, terminate the appointment of the Independent Engineer at any time, but only after appointment of another Independent Engineer.

18.4.2 If the TSP has reason to believe that the Independent Engineer is not discharging its duties and functions in a fair, efficient and diligent manner, it may make a written representation to the Nodal Agency and seek termination of the appointment of the Independent Engineer. Upon receipt of such representation, the Nodal Agency shall

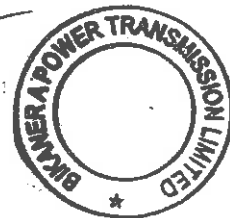

132

hold a tripartite meeting with the TSP and Independent Engineer for an amicable resolution, and the decision of Nodal agency is final. In the event that the appointment of the Independent Engineer is terminated hereunder, the Nodal Agency shall appoint forthwith another Independent Engineer.

18.5 Authorised signatories

The Nodal Agency shall require the Independent Engineer to designate and notify to the Nodal Agency up to 2 (two) persons employed in its firm to sign for and on behalf of the Independent Engineer, and any communication or document required to be signed by the Independent Engineer shall be valid and effective only if signed by any of the designated persons; provided that the Independent Engineer may, by notice in writing, substitute any of the designated persons by any of its employees.

Central Transmission Utility of India Limited

68

Bikaner A Power Transmission Limited

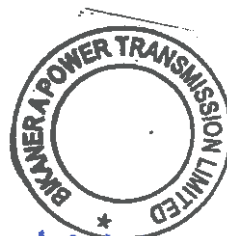
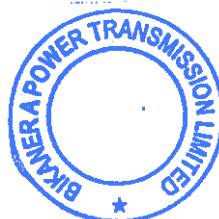
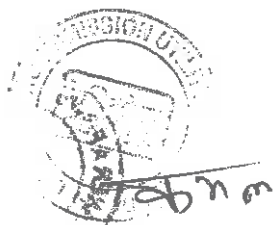

ARTICLE: 19

19 MISCELLANEOUS PROVISIONS

19.1 Equity Lock-in Commitment:

19.1.1 The aggregate equity share holding of the Selected Bidder in the issued and paid up equity share capital of Bikaner A Power Transmission Limited shall not be less than Fifty-one percent (51%) up to a period of one (1) year after COD of the Project.

Provided that, in case the Lead Member or Bidding Company is holding equity through Affiliate/s, Ultimate Parent Company or Parent Company, such restriction as specified above shall apply to such entities.

Provided further, that in case the Selected Bidder is a Bidding Consortium, the Lead Member shall continue to hold equity of at least twenty-six percent (26%) upto a period of one (1) year after COD of the Project and any Member of such Bidding Consortium shall be allowed to divest its equity as long as the other remaining Members (which shall always include the Lead Member) hold the minimum equity specified above.

19.1.2 If equity is held by the Affiliates, Parent Company or Ultimate Parent Company of the Selected Bidder, then, subject to the second proviso to Article 19.1.1, such Affiliate, Parent Company or Ultimate Parent Company shall be eligible to transfer its shareholding in Bikaner A Power Transmission Limited to another Affiliate or to the Parent Company / Ultimate Parent Company of the Selected Bidder. If any such shareholding entity, qualifying as an Affiliate / Parent Company / Ultimate Parent Company, is likely to cease to meet the criteria to qualify as an Affiliate / Parent Company / Ultimate Parent Company, the shares held by such entity shall be transferred to another Affiliate / Parent Company / Ultimate Parent Company of the Selected Bidder.

19.1.3 Subject to Article 19.1.1, all transfer(s) of shareholding Bikaner A Power Transmission Limited by any of the entities referred to in Article 19.1.1 and 19.1.2 above, shall be after prior written intimation to the Nodal Agency.

19.1.4 For computation of effective Equity holding, the Equity holding of the Selected Bidder or its Ultimate Parent Company in such Affiliate(s) or Parent Company and the equity holding of such Affiliate(s) or Ultimate Parent Company in Bikaner A Power Transmission Limited shall be computed in accordance with the example given below:

If the Parent Company or the Ultimate Parent Company of the Selected Bidder A

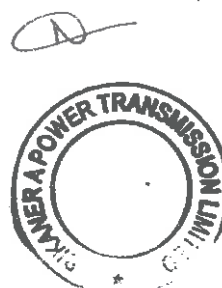
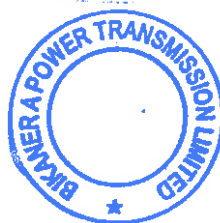
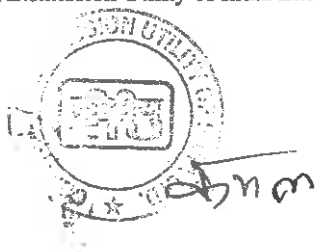

13/11/20

directly holds thirty percent (30%) of the equity in Bikaner A Power Transmission Limited, then holding of Selected Bidder A in Bikaner A Power Transmission Limited shall be thirty percent (30%);

If Selected Bidder A holds thirty percent (30%) equity of the Affiliate and the Affiliate holds fifty percent (50%) equity in Bikaner A Power Transmission Limited, then, for the purposes of ascertaining the minimum equity/equity lock-in requirements specified above, the effective holding of Bidder A Bikaner A Power Transmission Limited shall be fifteen percent (15%), (i.e., 30% x 50%)

- 19.1.5 The provisions as contained in this Article 19.1 shall override the terms of the consortium agreement submitted as part of the Bid.
- 19.1.6 The TSP shall be responsible to report to Nodal Agency, within thirty (30) days from the occurrence of any event that would result in any change in its equity holding structure from that which existed as on the date of signing of the Share Purchase Agreement. In such cases, the Nodal Agency would reserve the right to ascertain the equity holding structure and to call for all such required documents / information / clarifications as may be required.

19.2 Commitment of maintaining Qualification Requirement

- 19.2.1 The Selected Bidder will be required to continue to maintain compliance with the Qualification Requirements, as stipulated in RFP Document, till the COD of the Project. Where the Technically Evaluated Entity and/or the Financially Evaluated Entity is not the Bidding Company or a Member in a Bidding Consortium, as the case may be, the Bidding Company or Member shall continue to be an Affiliate of the Technically Evaluated Entity and/or Financially Evaluated Entity till the COD of the Project.
- 19.2.2 Failure to comply with the aforesaid provisions shall be dealt in the same manner as TSP's Event of Default as under Article 13 of this Agreement.

19.3 Language:

- 19.3.1 All agreements, correspondence and communications between the Parties relating to this Agreement and all other documentation to be prepared and supplied under the Agreement shall be written in English, and the Agreement shall be construed and interpreted in accordance with English language.
- 19.3.2 If any of the agreements, correspondence, communications or documents are prepared in any language other than English, the English translation of such agreements, correspondence, communications or documents shall prevail in matters of interpretation.

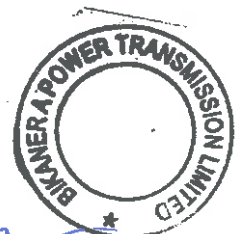
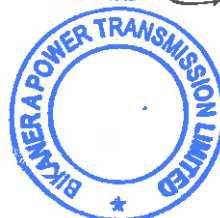
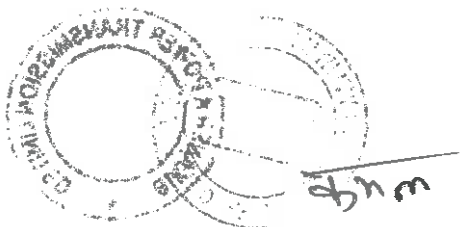

19.4 Affirmation

The TSP and the Nodal Agency, each affirm that:

1. neither it nor its respective directors, employees, or agents has paid or undertaken to pay or shall in the future pay any unlawful commission, bribe, pay-off or kick-back; and
2. it has not in any other manner paid any sums, whether in Indian currency or foreign currency and whether in India or abroad to the other Party to procure this Agreement, and the TSP and the Nodal Agency hereby undertake not to engage in any similar acts during the Term of Agreement.

19.5 Severability

The invalidity or enforceability, for any reason, of any part of this Agreement shall not prejudice or affect the validity or enforceability of the remainder of this Agreement, unless the part held invalid or unenforceable is fundamental to this Agreement.

19.6 Counterparts

This Agreement may be executed in one or more counterparts, each of which shall be deemed an original and all of which collectively shall be deemed one and the same Agreement.

19.7 Breach of Obligations/ Roles

The Parties acknowledge that a breach of any of the obligations/ roles contained herein would result in injuries. The Parties further acknowledge that the amount of the liquidated damages or the method of calculating the liquidated damages specified in this Agreement is a genuine and reasonable pre-estimate of the damages that may be suffered by the non-defaulting Party in each case specified under this Agreement.

19.8 Restriction of Shareholders / Owners Liability

- 19.8.1 Parties expressly agree and acknowledge that none of the shareholders of the Parties hereto shall be liable to the other Parties for any of the contractual obligations of the concerned Party under this Agreement.

Central Transmission Utility of India Limited

71

Bikaner A Power Transmission Limited

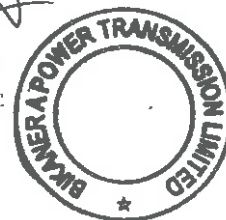
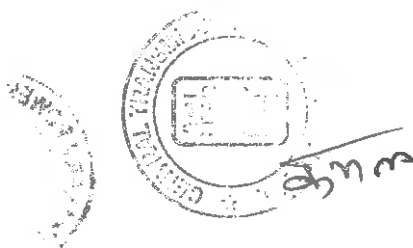

136

19.8.2 Further, the financial liabilities of the shareholder(s) of each Party to this Agreement shall be restricted to the extent provided in the Indian Companies Act, 1956 / Companies Act, 2013 (as the case may be).

19.9 Taxes and Duties:

19.9.1 The TSP shall bear and promptly pay all statutory taxes, duties, levies and cess, assessed/levied on the TSP, its Contractors or their employees that are required to be paid by the TSP as per the Law in relation to the execution of the Project and for providing Transmission Service as per the terms of this Agreement.

19.9.2 The Nodal Agency shall be indemnified and held harmless by the TSP against any claims that may be made against the Nodal Agency in relation to the matters set out in Article 19.9.1.

19.9.3 The Nodal Agency shall not be liable for any payment of, taxes, duties, levies, cess whatsoever for discharging any obligation of the TSP by the Nodal Agency on behalf of TSP or its personnel, provided the TSP has consented in writing to the Nodal Agency for such work, for which consent shall not be unreasonably withheld.

19.10 No Consequential or Indirect Losses

The liability of the TSP shall be limited to that explicitly provided in this Agreement.

Provided that, notwithstanding anything contained in this Agreement, under no event shall the Nodal Agency or the TSP claim from one another any indirect or consequential losses or damages.

19.11 Discretion:

Except where this Agreement expressly requires a Party to act fairly or reasonably, a Party may exercise any discretion given to it under this Agreement in any way it deems fit.

19.12 Confidentiality

19.12.1 The Parties undertake to hold in confidence this Agreement and RFP Project Documents and not to disclose the terms and conditions of the transaction contemplated hereby to third parties, except:

- (a) to their professional advisors;
- (b) to their officers, contractors, employees, agents or representatives, financiers, who need to have access to such information for the proper

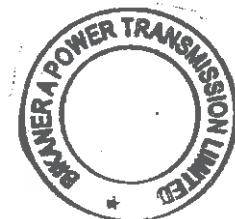
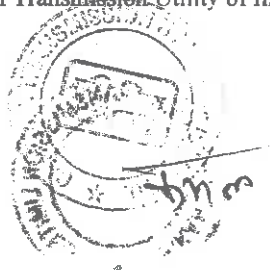

137

performance of their activities; or

(c) disclosures required under Law,

without the prior written consent of the other Parties.

Provided that, the TSP agrees and acknowledges that the Nodal Agency, may, at any time, disclose the terms and conditions of the Agreement and the RFP Project Documents to any person, to the extent stipulated under the Law and the Competitive Bidding Guidelines.

19.13 Order of priority in application:

Save as provided in Article 2.5, in case of inconsistencies between the terms and conditions stipulated in Transmission License issued by the Commission to the TSP, agreement(s) executed between the Parties, applicable Law including rules and regulations framed thereunder, the order of priority as between them shall be the order in which they are placed below:

- terms and conditions of Transmission License;
- applicable Law, rules and regulations framed thereunder;
- this Agreement;
- Agreement(s), if any, under Sharing Regulations.

19.14 Independent Entity:

19.14.1 The TSP shall be an independent entity performing its obligations pursuant to the Agreement.

19.14.2 Subject to the provisions of the Agreement, the TSP shall be solely responsible for the manner in which its obligations under this Agreement are to be performed. All employees and representatives of the TSP or Contractors engaged by the TSP in connection with the performance of the Agreement shall be under the complete control of the TSP and shall not be deemed to be employees, representatives, Contractors of the Nodal Agency and nothing contained in the Agreement or in any agreement or contract awarded by the TSP shall be construed to create any contractual relationship between any such employees, representatives or Contractors and the Nodal Agency.

19.15 Amendments:

19.15.1 This Agreement may only be amended or supplemented by a written agreement between the Parties.

Central Transmission Utility of India Limited 73

Bikaner A Power Transmission Limited

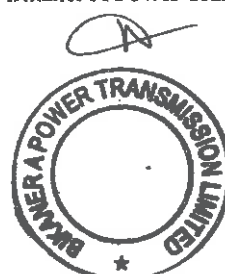
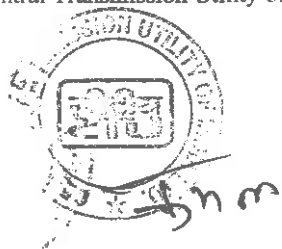

38

19.16 Waiver:

19.16.1 No waiver by either Party of any default or breach by the other Party in the performance of any of the provisions of this Agreement shall be effective unless in writing duly executed by an authorised representative of such Party.

19.16.2 Neither the failure by either Party to insist on any occasion upon the performance of the terms, conditions and provisions of this Agreement nor time or other indulgence granted by one Party to the other Parties shall act as a waiver of such breach or acceptance of any variation or the relinquishment of any such right or any other right under this Agreement, which shall remain in full force and effect.

19.17 Relationship of the Parties:

This Agreement shall not be interpreted or construed to create an association, joint venture, or partnership or agency or any such other relationship between the Parties or to impose any partnership obligation or liability upon either Party and neither Party shall have any right, power or authority to enter into any agreement or undertaking for, or act on behalf of, or to act as or be an agent or representative of, or to otherwise bind, the other Party.

19.18 Entirety:

19.18.1 This Agreement along with its sections, schedules and appendices is intended by the Parties as the final expression of their agreement and is intended also as a complete and exclusive statement of the terms of their agreement.

19.18.2 Except as provided in this Agreement, all prior written or oral understandings, offers or other communications of every kind pertaining to this Agreement or the provision of Transmission Service under this Agreement to the Nodal Agency by the TSP shall stand superseded and abrogated.

19.19 Notices:

19.19.1 All notices or other communications which are required to be given under this Agreement shall be in writing and in the English language

19.19.2 If to the TSP, all notices or communications must be delivered personally or by registered post or facsimile or any other mode duly acknowledged to the addressee below:

Address

Attention

Email

CORPORATE

Saudamini Plot No. 2,
Sector 29 Gurgaon
: Haryana - 122001
ED (TBCB)
: tbcbe@powergrid.in

BUSINESS

• POWERGRID NR-I RHR, SLO BAY
NO-5-10, Sec 16-A, Faridabad
Haryana-121001
• Project Incharge (BATL)
• tbcbe@powergrid.in

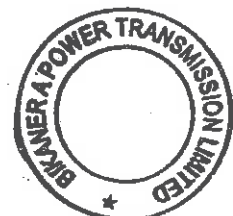
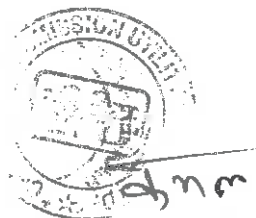

139

Fax No. :

Telephone No.:

19.19.3 If to the Nodal Agency, all notices or communications must be delivered personally or by registered post or facsimile or any other mode duly acknowledged to the addresses below:

(i) Central Transmission Utility of India Limited (Nodal Agency)

Address : 5th to 10th Floor, IRCON International Tower,
Tower no-1, Plot no -16 , Sector-32, Gurugram,
Haryana :122003

Attention : Mr. Atul Kumar Agarwal

Email : atul_ag@powergrid.in

Fax No. :-

Telephone No. : 9910378059

19.19.4 All notices or communications given by facsimile shall be confirmed by sending a copy of the same via post office in an envelope properly addressed to the appropriate Party for delivery by registered mail. All notices shall be deemed validly delivered upon receipt evidenced by an acknowledgement of the recipient, unless the Party delivering the notice can prove in case of delivery through the registered post that the recipient refused to acknowledge the receipt of the notice despite efforts of the postal authorities.

19.19.5 Any Party may by notice of at least fifteen (15) days to the other Party change the address and/or addresses to which such notices and communications to it are to be delivered or mailed.

19.20 Fraudulent and Corrupt Practices

19.20.1 The TSP and its respective officers, employees, agents and advisers shall observe the highest standard of ethics during the subsistence of this Agreement. Notwithstanding anything to the contrary contained in the Agreement, the Nodal Agency may terminate the Agreement without being liable in any manner whatsoever to the TSP, if it determines that the TSP has, directly or indirectly or through an agent, engaged in corrupt practice, fraudulent practice, coercive practice, undesirable practice or restrictive practice in the Bid process. In such an event, the Nodal Agency shall forfeit the Contract Performance Guarantee of the TSP, without prejudice to any other right or remedy that may be available to the

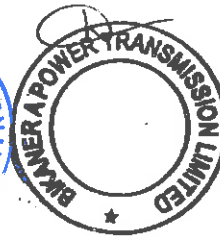
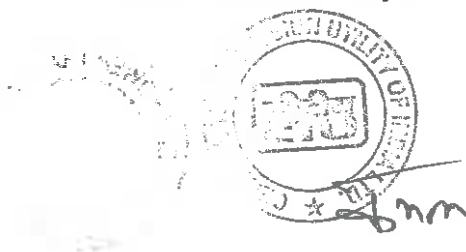

Nodal Agency hereunder or subsistence otherwise.

19.20.2 Without prejudice to the rights of the Nodal Agency under Clause 19.20.1 hereinabove and the rights and remedies which the Nodal Agency may have under this Agreement, if a TSP is found by the Nodal Agency to have directly or indirectly or through an agent, engaged or indulged in any corrupt practice, fraudulent practice, coercive practice, undesirable practice or restrictive practice during the Bid process, or after the issue of Letter of Intent (hereinafter referred to as LoI) or after the execution of the agreement(s) required under Sharing Regulations, the Nodal Agency may terminate the Agreement without being liable in any manner whatsoever to the TSP. Further, the TSP & its Affiliates shall not be eligible to participate in any tender or RFP issued by any BPC for an indefinite period from the date such TSP is found by the Nodal Agency to have directly or indirectly or through an agent, engaged or indulged in any corrupt practice, fraudulent practice, coercive practice, undesirable practice or restrictive practices, as the case may be.

19.20.3 For the purposes of this Clause 19.20, the following terms shall have the meaning hereinafter respectively assigned to them:

(a) **“corrupt practice”** means (i) the offering, giving, receiving, or soliciting, directly or indirectly, of anything of value to influence the actions of any person connected with the Bid process (for avoidance of doubt, offering of employment to or employing or engaging in any manner whatsoever, directly or indirectly, any official of the BPC who is or has been associated or dealt in any manner, directly or indirectly with the Bid process or the LoI or has dealt with matters concerning the RFP Project Documents or arising there from, before or after the execution thereof, at any time prior to the expiry of one year from the date such official resigns or retires from or otherwise ceases to be in the service of the BPC, shall be deemed to constitute influencing the actions of a person connected with the Bid Process); or (ii) engaging in any manner whatsoever, whether during the Bid Process or after the issue of the LoI or after the execution of the RFP Project Documents, as the case may be, any person in respect of any matter relating to the Project or the LoI or the RFP Project Documents, who at any time has been or is a legal, financial or technical adviser of the BPC in relation to any matter concerning the Project;

(b) **“fraudulent practice”** means a misrepresentation or omission of facts or suppression of facts or disclosure of incomplete facts, in order to influence the Bid process;

(c) **“coercive practice”** means impairing or harming, or threatening to impair or harm, directly or indirectly, any person or property to influence any person’s participation or action in the Bid process;

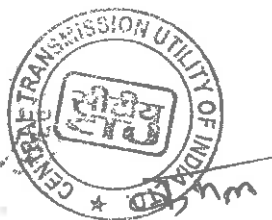

M1

(d) "undesirable practice" means (i) establishing contact with any person connected with or employed or engaged by the BPC with the objective of canvassing, lobbying or in any manner influencing or attempting to influence the Bid process; or (ii) having a Conflict of Interest; and

(e) "restrictive practice" means forming a cartel or arriving at any understanding or arrangement among Bidders with the objective of restricting or manipulating a full and fair competition in the Bid process;

19.21 Compliance with Law:

Despite anything contained in this Agreement but without prejudice to Article 12, if any provision of this Agreement shall be in deviation or inconsistent with or repugnant to the provisions contained in the Electricity Act, 2003, or any rules and regulations made there under, such provision shall be deemed to be amended to the extent required to bring it into compliance with the aforesaid relevant provisions as amended from time to time.

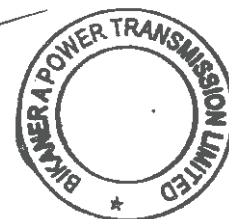
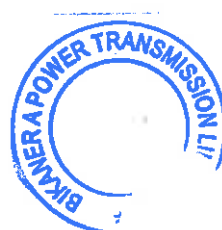

142

IN WITNESS WHEREOF, THE PARTIES HAVE CAUSED THIS AGREEMENT TO BE EXECUTED BY THEIR DULY AUTHORISED REPRESENTATIVES AS OF THE DATE AND PLACE SET FORTH ABOVE.

1. For and on behalf of TSP

Naresh
.....

[Signature, Name, Designation and Address]

NARESH KUMAR
Finance Incharge

2. For and on behalf of CTUIL [Insert name of the Nodal Agency]

Kamal Kumar Jain
.....

[Signature, Name, Designation and Address]

KAMAL KUMAR JAIN
Senior General Manager
CENTRAL TRANSMISSION UTILITY OF INDIA LTD
Power Grid Corporation of India Ltd
(A Government of India Enterprises)
Plot No -2, Sector-29, Gurgaon- 122 001 (Haryana)

WITNESSES:

1. For and on behalf of

: BPC

Ritani Bhaswas
.....

[Signature]

RITANI BHASWAS
AM (BNGA.), RBCPDCL

[Insert, Name, Designation and Address of the Witness]

2. For and on behalf of

: Nodal Agency

Deepak Krishnam
.....

[Signature]

Deepak Krishnam, manager, CTUIL

[Insert Name, Designation and Address of the Witness]

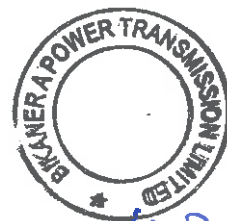

SCHEDULES

Central Transmission Utility of India Limited

79

Bikaner A Power Transmission Limited

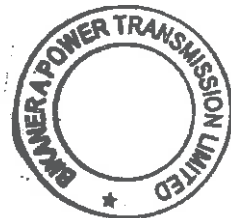
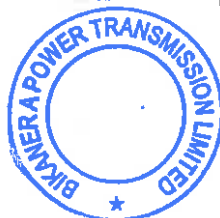
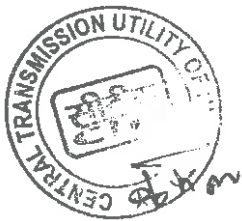

144

Schedule: 1

Project Description and Scope of Project

Scope of the Project:

Sl. No.	Scope of the Transmission Scheme	Scheduled COD in months from Effective Date
1	<p>Establishment of 6x1500 MVA, 765/400 kV and 6x500 MVA, 400/220 kV Bikaner-IV Pooling Station along with 2x240 MVA (765 kV) and 2x125 MVA (420 kV) Bus Reactors at a suitable location near Bikaner</p> <p>Bikaner-IV PS -AIS</p> <ul style="list-style-type: none"> • 765/400 kV 1500 MVA ICTs- 6 Nos. (19x500 MVA including one spare unit) • 400/220 kV 500 MVA ICTs -6 Nos. • 765 kV line bays – 2 Nos. (for 765 kV interconnection with Siwani S/s) • 400 kV line bays - 4 Nos. (For LILO of both ckts of Bikaner II PS- Bikaner III PS) • 765 kV ICT bays-6 Nos. • 400 kV ICT bays- 12 Nos. • 220 kV ICT bays- 6 Nos. • 240 MVA Bus Reactor-2 Nos. (7x80 MVA, including one spare unit) • 765 kV Bus reactor bays-2 Nos. • 125 MVA Bus Reactor-2 Nos. • 400 kV Bus reactor bays- 2 Nos. • 220 kV line bays: 6 Nos. (for RE connectivity) • 400 kV line bays (for RE connectivity)- 3 Nos. • 400 kV Sectionalizer bay: 1 set • 220 kV Sectionalizer bay: 1 set • 220 kV BC (2 Nos.) bays and 220 kV TBC (2 Nos.) bays • 400 kV bays: 2 Nos. (for STATCOM) <p>Future provisions at Bikaner-IV PS: Space for</p> <ul style="list-style-type: none"> • 765 kV line bays along with switchable line reactors – 8 Nos. • 765 kV Bus Reactor along with bay: 1 No. 	11/11/2026

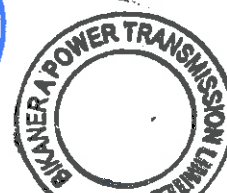
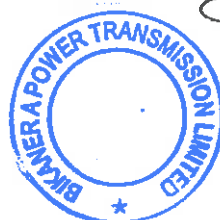

	<ul style="list-style-type: none"> ◦ 400 kV line bays along with switchable line reactor –4 Nos. ◦ 400 kV line bays–2 Nos. ◦ 400/220 kV ICT along with bays -4 Nos. ◦ 400 kV Bus Reactor along with bay: 1 No. ◦ 400 kV Sectionalizer bay: 1 set ◦ 220 kV line bays for connectivity of RE Applications -5 Nos. ◦ 220 kV Sectionalizer bay: 2 sets ◦ 220 kV BC (2 Nos.) bays and 220 kV TBC (2 Nos.) bays
2	<p>STATCOM (2x±300 MVA_r) along with MSC (4x125 MVA_r) and MSR (2x125 MVA_r) at Bikaner-IV PS</p> <ul style="list-style-type: none"> • STATCOM (2x±300 MVA_r) along with MSC (4x125 MVA_r) and MSR (2x125 MVA_r)
3	LILO of both ckts of Bikaner II PS- Bikaner III PS (Quad) direct 400 kV line at Bikaner-IV PS
4	<p>Bikaner-IV PS – Siwani 765 kV D/C line along with 240 MVA_r switchable line reactor for each circuit at each end</p> <ul style="list-style-type: none"> • 765 kV, 240 MVA_r switchable line reactors at Bikaner-IV PS end– 2 Nos. • 765 kV, 240 MVA_r switchable line reactors at Siwani S/s end– 2 Nos. • Switching equipment for 765 kV, 240 MVA_r switchable line reactors at Bikaner-IV PS end – 2 Nos. • Switching equipment for 765 kV, 240 MVA_r switchable line reactors at Siwani S/s end – 2 Nos.
5	Siwani– Fatchabad (PG) 400 kV D/C line (Quad)
6	<p>Siwani – Patran (Indi Grid) 400 kV D/C line (Quad) along with 80 MVA_r switchable line reactor for each circuit at Siwani S/s end</p> <ul style="list-style-type: none"> • 420 kV, 80 MVA_r switchable line reactors at Siwani S/s end– 2 Nos.

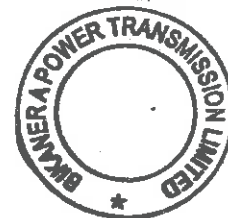
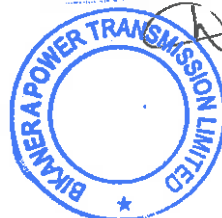
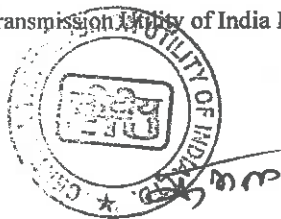

	<ul style="list-style-type: none"> Switching equipment for 420 kV, 80 MVAR switchable line reactors at Siwani S/s end – 2 Nos. 400 kV GIS duct :700 m at Patran S/s
7	<p>2 Nos. 400 kV line bays each at Fatehabad (PG) and Patran (Indi Grid) GIS S/s</p> <ul style="list-style-type: none"> 400 kV line bays at Fatehabad (PG) S/s – 2 Nos. 400 kV GIS line bays at Patran (Indi Grid) S/s – 2 Nos.
8	<p>2 Nos. 765 kV line bays at Siwani S/s</p> <ul style="list-style-type: none"> 765 kV line bays at Siwani S/s – 2 Nos.
9	<p>4 Nos. 400 kV line bays at Siwani S/s</p> <ul style="list-style-type: none"> 400 kV line bays at Siwani S/s – 4 Nos. (for 400 kV interconnections)

Project Description

Transmission scheme for evacuation requirement of additional 6 GW RE potential from Bikaner Complex (Bikaner-IV) has been evolved.

As part of above comprehensive scheme, 765/400/220 kV Bikaner-IV PS is being established for RE injection along with its 400 kV D/C interconnections to Bikaner-II PS and Bikaner-III PS (through LILO). For onwards evacuation of power from Bikaner-IV PS, 765/400 kV Siwani S/s is being established along with 765 kV interconnections with Bikaner-IV PS through 2xD/C lines. For further dispersal of power towards load centers, 400 kV D/C interconnections with Jind (PG), Sonipat (PG), Patran (Indi Grid) and Fatehabad (PG) S/s are also being implemented.

The subject transmission scheme i.e., Transmission system for evacuation of power from Rajasthan REZ Ph-IV (Part-3: 6GW) [Bikaner complex]: Part-A involves establishment of 765/400/220 kV Bikaner-IV S/s and its 400 kV D/C interconnections to Bikaner-II PS and Bikaner-III PS (through LILO). Bikaner-IV PS is being interconnected with Siwani S/s through 765 kV D/C line and Fatehabad (PG) and Patran (Indi Grid) S/s at 400 kV D/C lines. STATCOM (2x+300 MVar) along with MSC/MSR at Bikaner-IV PS is also being implemented as part of above scheme.

Above transmission scheme was agreed in the 27th CMETS-NR meeting held on 10.01.2024 and 71st NRPC meeting held on 29.01.2024. Transmission System was further agreed in 18th National Committee on Transmission (NCT) held on 05.03.2024. Subsequently, Ministry of Power, Government of India, vide its Gazette Notification CG-

Central Transmission Utility of India Limited

82

Bikaner A Power Transmission Limited

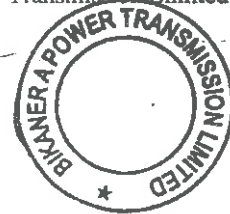
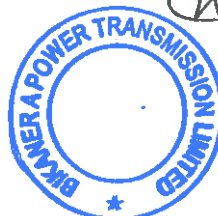
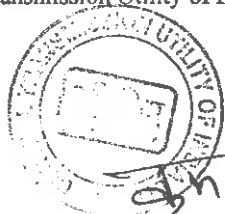

147

DL-E-15032024-253080 dated 15.03.24 declared establishment of Transmission system for evacuation of power from Rajasthan REZ Ph-IV (Part-3: 6GW) [Bikaner complex]: Part-A through tariff based competitive bidding process route

Central Transmission Utility of India Limited

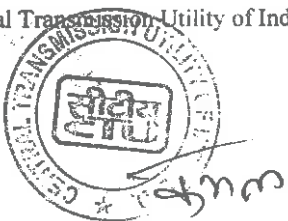

83

Bikaner A Power Transmission Limited

A handwritten signature in black ink.

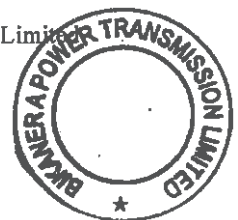

148

SPECIFIC TECHNICAL REQUIREMENTS FOR TRANSMISSION LINE

- A.1.0 The design, routing and construction of transmission lines shall be in accordance with Chapter V, Part-A of CEA (Technical Standards for Construction of Electrical Plants and Electric Lines) Regulations 2022, as amended from time to time. Other CEA Regulations and MoP guidelines, as applicable, shall also be followed.
- A.2.0 Selection of tower type shall be made as per CEA Regulations, however in case lattice type towers are used, the following shall also be applicable:
- A.2.1 Steel section of grade E 250 and/or grade E 350 as per IS 2062, only are permitted for use in towers, extensions, gantry structures and stub setting templates. For towers in snowbound areas, steel sections shall conform to Grade-C of IS-2062.
- A.2.2 Towers shall be designed as per IS-802:2015, however the drag coefficient of the tower shall be as follows: -

Solidity Ratio	Drag Coefficient
Up to 0.05	3.6
0.1	3.4
0.2	2.9
0.3	2.5
0.4	2.2
0.5 and above	2.0

- A.3.0 Transmission Service Provider (TSP) shall adopt any additional loading/design criteria for ensuring reliability of the line, if so desired and /or deemed necessary.
- A.4.0 Transmission line shall be designed considering wind zones as specified in wind map given in National Building Code 2016, Vol.1. The developer shall also make his own assessment of local wind conditions and frequent occurrences of high intensity winds (HIW) due to thunderstorms, dust-storms, downburst etc. along the line route and wherever required, higher wind zone than that given in wind map shall be considered for tower design for ensuring reliability of line. Further, for transmission line sections passing within a distance of 50 km from the boundary of two wind zones, higher of the two wind zones shall be considered for design of towers located in such sections.

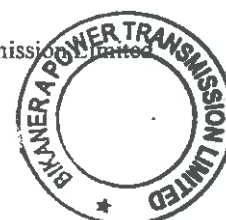
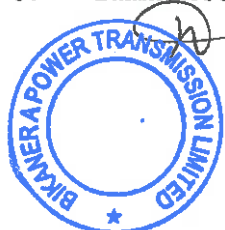
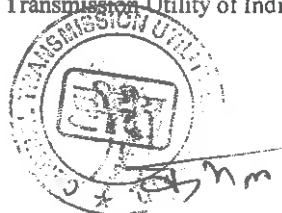

- A.5.0 Selection of reliability level for design of tower shall be as per CEA Regulation (Technical Standards for Construction of Electrical Plants and Electric Lines) Regulations 2022, as amended from time to time.
- A.6.0 A) For power line crossing of 400 kV or above voltage level, large angle and dead end towers (i.e. D/DD/QD) shall be used on either side of power line crossing.
- B) For power line crossing of 132 kV and 220 kV voltage level, angle towers (B/C/D/DB/DC/DD/ QB/QC/QD) shall be used on either side of power line crossing depending upon the merit of the prevailing site condition and line deviation requirement.
- C) For power line crossing of 66 kV and below voltage level, suspension/tension towers shall be provided on either side of power line crossing depending upon the merit of the prevailing site condition and line deviation requirement.
- D) For crossing of railways, national highways and state highways, the rules/regulations of appropriate authorities shall be followed.
- A.7.0 (a) The relevant conductor configuration shall be as follows: -

Name of line: **Bikaner-IV PS – Siwani 765 kV D/C line**

Type of conductor: ACSR / AAAC / AL59

Basic parameters:

Transmission line	ACSR Conductor specified	Equivalent AAAC conductor based on 53.5% conductivity of Al Alloy	Equivalent minimum size of AL59 conductor based on 59% conductivity of AL Alloy*	Sub-conductor Spacing
765 kV D/C (Hexa Bundle) Transmission Lines	Zebra: Stranding 54/3.18 mm- Al + 7/3.18 mm-Steel, 28.62 mm diameter 428 mm ² , Aluminium area,	Stranding details: 61/3.19 mm, 28.71 mm diameter; 487.5 mm ² Aluminium alloy area Maximum DC Resistance at	Stranding details: 61/3.08 mm, 27.72 mm diameter; 454 mm ² Aluminium alloy area Maximum DC Resistance at	457 mm

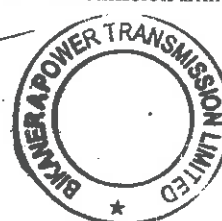
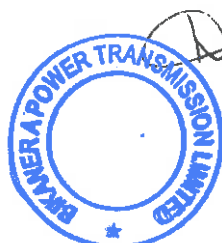

Transmission line	ACSR Conductor specified	Equivalent AAAC conductor based on 53.5% conductivity of Al Alloy	Equivalent minimum size of AL59 conductor based on 59% conductivity of AL Alloy*	Sub-conductor Spacing
	Maximum DC Resistance at 20°C (Ω/km): 0.06868 Minimum UTS: 130.32 kN	20°C (Ω/km) : 0.06815 Minimum UTS: 135.6 kN	20°C (Ω/km) : 0.0653 Minimum UTS: 108 kN	

(b) The relevant conductor configuration of below lines shall be as follows: -

(i) LILO of both ckts of Bikaner II PS- Bikaner III PS (Quad) direct line at Bikaner-IV PS,

(ii) Siwani– Fatehabad (PG) 400 kV D/C line (Quad)

(iii) Siwani – Patran (Indi Grid) 400 kV D/C line

Type of conductor: ACSR / AAAC / AL59

Basic parameters:

Transmission line	ACSR Conductor specified	Equivalent AAAC conductor based on 53% conductivity of Al Alloy	Equivalent minimum size of AL59 conductor based on 59% conductivity of AL Alloy*	Sub-conductor Spacing
400 kV D/C (Quad Bundle)	Moose: Stranding 54/3.53 mm-Al	Stranding details: 61/3.55 mm	Stranding details: 61/3.31 mm	

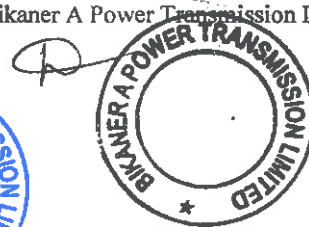
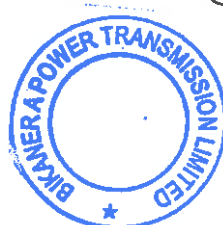
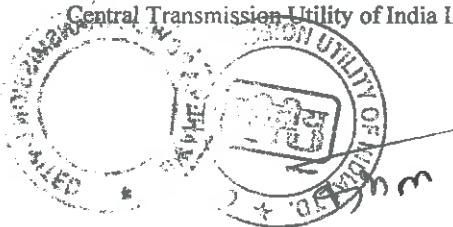

Transmission line	ACSR Conductor specified	Equivalent AAAC conductor based on 53% conductivity of Al Alloy	Equivalent minimum size of AL59 conductor based on 59% conductivity of AL Alloy*	Sub-conductor Spacing
transmission lines	+ 7/3.53 mm-Steel, 31.77 mm diameter 528.5 mm ² , Aluminium area, Maximum DC Resistance at 20°C (Ω/km): 0.05552 Minimum UTS: 161.20 kN	31.95 mm diameter; 604 mm ² Aluminium alloy area Maximum DC Resistance at 20°C (Ω/km): 0.05506 Minimum UTS: 159.80 kN	29.79 mm diameter; 525 mm ² Aluminium alloy area Maximum DC Resistance at 20°C (Ω/km): 0.0566 Minimum UTS: 124.70 kN	457 mm

Note:

- *To select any size above the minimum, the sizes mentioned in the Indian standard IS-398(part-6) shall be followed.*
- The transmission lines shall have to be designed for a maximum operating conductor temperature of 85 deg C.*

A.8.0 The required phase to phase spacing and horizontal spacing for 765 kV and 400 kV line(s) shall be governed by the tower design as well as minimum live metal clearances for 765 kV and 400 kV voltage level under different insulator swing angles. However, the phase to phase spacing for 765 kV and 400 kV lines shall not be less than 15 m and 8 m respectively.

A.9.0 All electrical clearances including minimum live metal clearance, ground clearance and minimum mid span separation between earth wire and conductor as given below shall be considered:

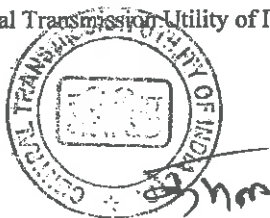

CA



152

I. Minimum live metal clearances for 765 kV line

- a) (i) Under stationary conditions

From tower body: For 765 kV D/C: 6.1 m

For 765 kV S/C: 5.6 m

- (ii) Under swing conditions

Wind Pressure Condition	Minimum Electrical Clearance
a) Swing angle (25°)	4.4 m
b) Swing angle (55°)	1.3 m

- b) Minimum ground clearance for 765 kV: 18 m

- c) Minimum mid span separation between earthwire and conductor for 765 kV: 9.0 m

II. Minimum live metal clearances for 400 kV line:

- a) (i) Under stationary conditions:

From tower body: 3.05 m

- (ii) Under Swing conditions

Wind Pressure Condition	Minimum Electrical Clearance
a) Swing angle (22°)	3.05 m
b) Swing angle (44°)	1.86 m

- b) Minimum ground clearance for 400 kV: 8.84 m

- c) Minimum mid span separation between earthwire and conductor for 400 kV: 9.0 m.

A.10.0 Shielding angle shall not exceed 10 deg for 765 kV D/C and 20 deg for 400 kV transmission line.

A.11.0 The Fault current for design of line shall be 50 kA for 1 sec for 765 kV and 63 kA for 1 sec for 400 kV.

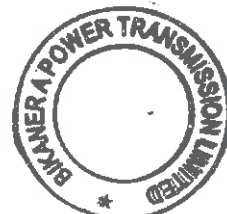
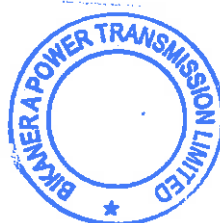
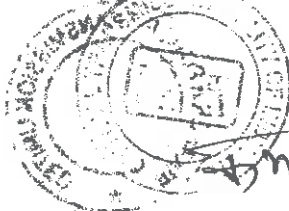

- A.12.0 In case of 765 kV and 400 kV voltage class lines, at least one out of two earth wires shall be OPGW and second earth wire, if not OPGW, shall be either of Galvanized Stranded Steel (GSS) or Aluminum Alloy Conductor Steel Reinforced (AACSR) conductor type or any other suitable conductor type depending upon span length and other technical consideration.
- A.13.0 Each tower shall be earthed such that tower footing impedance does not exceed 10 ohms. Pipe type or Counterpoise type earthing shall be provided in accordance with relevant IS. Additional earthing shall be provided on every 7 to 8 kms distance for direct earthing of both shield wires. If site condition demands, multiple earthing or use of earthing enhancement compound shall be used.
- A.14.0 Pile type foundation shall be used for towers located in river or creek bed or on bank of river having scourable strata or in areas where river flow or change in river course is anticipated, based on detailed soil investigation and previous years' maximum flood discharge of the river, maximum velocity of water, highest flood level, scour depth and anticipated change in course of river based on river morphology data of at least past 20 years to ensure availability and reliability of the transmission line.
- A.15.0 Transmission line route shall be finalized, in consultation with appropriate authorities so as to avoid the habitant zones of endangered species and other protected species. Bird diverters, wherever required, shall be provided on the line. In order to optimize the route use of GATISHAKTI platform shall also be made.
- A.16.0 Wherever, transmission lines are passing through cyclone prone areas (i.e. areas up to 60 km from coast)/ creek regions/ aggressive soil areas following shall also be applicable:
- The fabricated tower parts and stubs shall have a minimum overall zinc coating of 900 g/m² of surface area except for plates and sections below 5 mm which shall have a minimum overall zinc coating of 610 g/m² of surface area. The average zinc coating for all sections and plates 5 mm and above shall be maintained as 127 microns and that for plates and sections below 5 mm shall be maintained as 87 microns.
 - Ready mix concrete of M30 Grade shall be used to avoid use of locally available saline water. However, design mix concrete of M30 Grade conforming to IS 456 with potable water can be used at locations where transportation of ready-mix concrete is not feasible. Minimum cement content in any case shall not be less than 330 kg/m³.
 - The surface of the reinforced steel shall be treated with epoxy-based coating to enhance corrosion performance of foundation. Use of epoxy coated reinforcement in foundation shall be as per IS 13620. In addition, two (2) coats of bituminous painting of minimum 1.6 kg/m² per coat shall be applied on all exposed faces of foundation (i.e. pedestal and base slab).
 - Double coat 20 mm thick cement plaster shall be provided on all exposed concrete

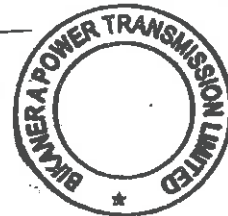
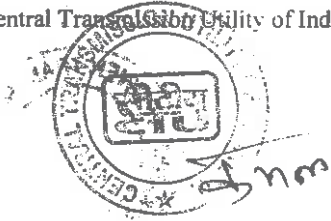

surface as well up to 300 mm below ground level to give protection to concrete surface from environmental and saline effect.

- e) Before coping of chimney top portion, three coats of anti-corrosive paint of minimum 30-35 microns dry film thickness each shall be applied on the stub in the 50 mm coping portion as well as up to 350 mm above CL portion.

- A.17.0 The raised chimney foundation is to be provided in areas prone to flooding/water stagnation like paddy field /agricultural field and undulated areas to avoid direct contact of water with steel part of tower. The top of the chimney of foundation should be at least above HFL (High Flood Level) or the historical water stagnation/ logging level (based on locally available data) or above High Tide Level or 500 mm above Natural Ground level (whichever is higher).
- A.18.0 Routing of transmission line through protected areas of India shall be avoided to the extent possible. In case, it is not possible to avoid protected areas, the towers of the transmission line up to 400 kV level which are installed in protected areas shall be designed for Multi-circuit (4 circuits) configuration of same voltage level considering reliability level of at least two (2). The top two circuits of these multi-circuit towers shall be used for stringing of the transmission line under present scope and the bottom two circuits shall be made available for stringing of any future transmission line of any transmission service providers/ State transmission utilities/Central transmission utilities passing through the same protected area. Further, the configuration and coordinates of such transmission towers shall be submitted to CEA, CTU and BPC by the TSP.
- A.19.0 The TSP shall abide by the Guidelines of CEA w.r.t. shifting of transmission lines for NHAI projects and other projects.
- A.20.0 Safety precautions in regards to gas/oil pipelines in vicinity of Transmission lines shall be taken in coordination with gas/ petroleum authorities.

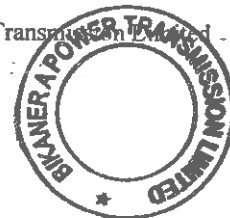
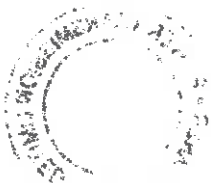

155

SPECIFIC TECHNICAL REQUIREMENTS FOR SUBSTATION

The proposed new 765/400/220 kV substation at Bikaner-IV (AIS) generally conforms to the requirements of CEA (Technical Standards for Construction of Electrical Plants and Electric Lines) Regulations 2022, as amended from time to time.

Extension of 400 kV Siwani, 400 kV Fatehabad (PG) substation shall be conventional AIS type generally conforming to the requirements of CEA (Technical Standards for Construction of Electrical Plants and Electric Lines) Regulations 2022, as amended from time to time.

Extension of 400 kV Patran (Indi Grid) substation shall be GIS type generally conforming to the requirements of CEA (Technical Standards for Construction of Electrical Plants and Electric Lines) Regulations 2022, as amended from time to time.

Other CEA Regulations /guidelines as amended up to date and MoP guidelines, as applicable, shall also be followed.

B.1.0 Salient features of Substation Equipment and Facilities

The design and specification of substation equipment are to be governed by the following factors:

B.1.1 Insulation Coordination

The system design parameters for substations/switchyards shall be as given below:

Sl. No.	Description of parameters	765/400/220 kV Bikaner-IV S/s			Extn. of 400 kV Siwani / Fatehabad (PG) / Patran (Indi Grid) S/s	Extn. of 765 kV Siwani s/s
		765 kV System	400 kV System	220 kV System		
1.	System operating voltage	765 kV	400 kV	220 kV	400 kV	765 kV

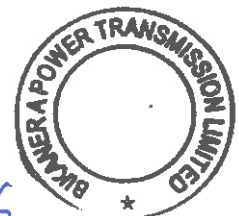

Sl. No.	Description of parameters	765/400/220 kV Bikaner-IV S/s			Extn. of 400 kV Siwani / Fatehabad (PG) / Patran (Indi Grid) S/s	Extn. of 765 kV Siwani s/s
		765 kV System	400 kV System	220 kV System	400 kV System	765 kV System
2.	Maximum voltage of the system (rms)	800 kV	420 kV	245 kV	420 kV	800 kV
3.	Rated frequency	50 Hz	50 Hz	50 Hz	50 Hz	50 Hz
4.	No. of phases	3	3	3	3	3
5.	Rated Insulation levels					
i)	Lightning Impulse withstand voltage for (1.2/50 micro sec.)					
	- for Equipment other than Transformer and Reactor	2100 kVp	1425 kVp	1050 kVp	1425 kVp	2100 kVp
	- for Insulator String	2100 kVp	1550 kVp	1050 kVp	1550 kVp	2100 kVp
ii)	Switching impulse			-		

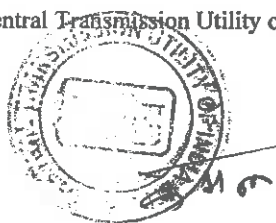

Sl. No.	Description of parameters	765/400/220 kV Bikaner-IV S/s			Extn. of 400 kV Siwani / Fatehabad (PG) / Patran (Indi Grid) S/s	Extn. of 765 kV Siwani s/s
		765 kV System	400 kV System	220 kV System	400 kV System	765 kV System
	withstand voltage (250/2500 micro sec.) dry and wet	1550 kVp	1050 kVp		1050 kVp	1550 kVp
iii)	One-minute power frequency dry withstand voltage (rms)	830 kV	630 kV	-	630 kV (AIS)/ 650 kV (GIS)	830 kV
iv)	One minute power frequency dry and wet withstand voltage (rms)	-	-	460 kV	-	-
6.	Corona extinction voltage	508 kV	320 kV	-	320 kV	508 kV
7.	Max. radio interference voltage for frequency between 0.5 MHz and 2 MHz	2500 micro-volts at 508 kV rms	1000 micro-volts at 266 kV rms	1000 micro-volts at 156 kV rms	1000 micro-volts at 266 kV rms	2500 micro-volts at 508 kV rms

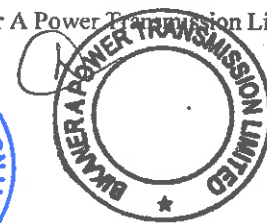

Sl. No.	Description of parameters	765/400/220 kV Bikaner-IV S/s			Extn. of 400 kV Siwani / Fatehabad (PG) / Patran (Indi Grid) S/s	Extn. of 765 kV Siwani s/s
		765 kV System	400 kV System	220 kV System	400 kV System	765 kV System
8.	Minimum creepage distance for insulator string/ longrod insulators/ outdoor bushings	24800 mm (31 mm/kV)	13020 mm (31 mm/kV)	7595 mm (31 mm/kV)	13020 mm (31 mm/kV)	24800 mm (31 mm/kV)
9.	Minimum creepage distance for switchyard equipment	20000 mm (25 mm/kV)	10500 mm (25 mm/kV)	6125 mm (25 mm/kV)	10500 mm (25 mm/kV)	20000 mm (25 mm/kV)
10.	Max. fault current	50 kA	63 kA	50 kA	63 kA	50 kA
11.	Duration of fault	1 sec	1 Sec	1 Sec	1 Sec	1 sec

B.1.2 Switching Scheme

The switching schemes, as mentioned below, shall be adopted at various voltage levels of substation/switchyard:

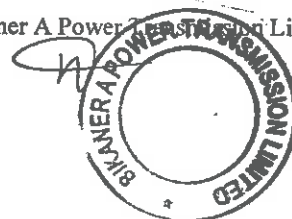

Substation	765 kV side	400 kV side	220 kV side
765/400/220 kV Bikaner-IV S/s (AIS)	One and half breaker	One and half breaker	Double Main and Transfer
Extn. of 765/400 kV Siwani S/s (AIS)	One and half breaker	One and half breaker	--
Extn. of 400 kV Fatehabad (PG) S/s (AIS)	--	One and half breaker	--
Extn. of 400 kV Patran (Indi Grid) S/s (GIS)	--	One and half breaker	--

Notes: -

- (i) For one and half breaker switching scheme, any double circuit line consisting of two numbers of feeders and originating from the same transmission or generating switchyard shall not be terminated in one diameter.
- (ii) Two transformers of same HV rating shall not be connected in the same diameter and similarly, two bus reactors of same HV rating shall also not be connected in the same diameter.
- (iii) 400 kV Bus Sectionalizers shall be placed such that each section shall have even distribution of Poles, ICT, Feeders and filter bank(s)/sub-bank(s) so as to have maximum operational flexibility.
- (iv) A diameter in one and half breaker scheme is a set of 3 circuit breakers with associated isolators, earth switches, current transformers etc. for controlling 2 (two) numbers of feeders.
- (v) In case of GIS substation where the bus scheme is One and Half breaker scheme, the diameters shall be complete with feeder/line side isolator and GIS duct of the future bay shall be brought outside the GIS hall/building with extension/interface module suitably.
- (vi) Connection arrangement of Switchable Line reactors shall be such that it can be used as Line reactor as well as Bus reactor with suitable NGR bypass arrangement. Further, Spare 1-phase Shunt Reactor unit shall be placed and connected in such a way that the spare unit can be utilized for all the bus and switchable line reactor banks (including future reactor banks) without its physical movement.

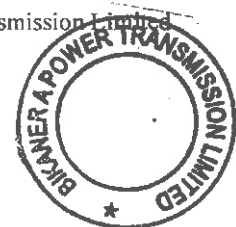
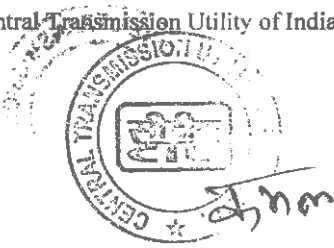

- (vii) Space provision for 765 kV and 400 kV Present as well as Future lines shall be kept considering switchable Line reactor for the lines.
- (viii) One (1) set of bus sectionalizer for 400 kV shall comprise 2 Nos. of bus sectionalizer bays with associated Circuit Breakers, Isolators and Current Transformers for both Main-I and Main-II buses.
- (ix) One (1) set of bus sectionalizer for 220 kV shall comprise 2 Nos. of bus sectionalizer bays with associated Circuit Breakers, Isolators and Current Transformers for both buses.
- (x) TSP shall plan distribution of line and transformer feeders to bus bar in such a way that all power can be evacuated successfully without crossing the thermal limit at any point of bus bar.

(xi) Extension of Patran (Indi Grid) S/s:

For Siwani- Patran 400 kV D/C transmission line, one circuit shall be terminated in existing GIS bay module No. 411 and other circuit shall be terminated in new bay No. 414 at Patran S/s. Single Line Diagram with bay identification is attached with the RfP document. Further, all associated interconnection work shall also be in the present scope of TSP. Accordingly, 1 (one) number new GIS diameter shall be constructed under present scope and the bay configuration of the new diameter shall be Line (414) -Tie (415)- ICT (416). GIS module of bay No. 416 executed under present scope for the requirement of diameter completion, shall be utilized for termination of future ICT.

(xii) Extension of Fatehabad (PG) S/s:

For Siwani- Fatehabad 400 kV D/C transmission line, both circuits shall be terminated in new diameters at Fatehabad S/s. Accordingly, 2 (two) number half diameter (consisting of Main and associated Tie Bay) shall be constructed under present scope. Further, all associated interconnection work shall also be in the present scope of TSP.

(xiii) Extension of Siwani S/s:

For Siwani- Fatehabad 400 kV D/C transmission line, one circuit shall be terminated in new half diameter (consisting of Main and associated Tie Bay) and other circuit shall be terminated in existing diameter where tie bay shall be provided by the developer of Siwani S/s. Further, all associated interconnection work shall also be in the present scope of TSP.

For Siwani- Patran 400 kV D/C transmission line, one circuit shall be terminated in new half diameter (consisting of Main and associated Tie Bay) and other circuit shall be terminated in existing diameter where tie bay shall be provided by developer of

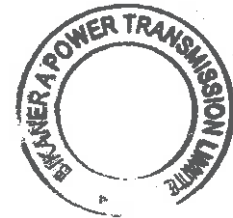
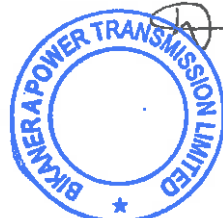
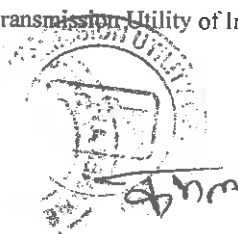

Siwani S/s. Further, all associated interconnection work shall also be in the present scope of TSP.

bay shall be available for termination both circuits at Siwani S/s. (These D/C circuits are in the scope of developer of Transmission system for evacuation of power from Rajasthan REZ Ph-IV (Part- 3,6 GW) [Bikaner complex]: Part-B".)

Further, all associated interconnection work shall also be in the present scope of TSP

(xiv) **Bikaner-IV S/s:**

(i) 400 kV Bus Sections shall be with the following feeder distribution.

400 kV Bus Section-1	400 kV Bus Section-2
a) 3 Nos. of 765/400 kV ICT b) 3 Nos. of 400/220 kV ICT c) 4 Nos. 400 kV Line d) 1 No. Bus Reactor e) 1 No. STATCOM	a) 3 Nos. of 765/400 kV ICT b) 3 Nos. of 400/220 kV ICT c) 3 Nos. 400 kV Line d) 1 No. Bus Reactor e) 1 No. STATCOM

(ii) 220 kV Bus Section shall be with the following feeder distribution.

220 kV Bus Section-1	220 kV Bus Section-2
a) 3 Nos. of 400/220 kV ICT b) 3 Nos. of 220 kV Line c) 1 No. Bus coupler and 1 No. Transfer bus coupler d) Provision for 01 No. future Line bays.	a) 3 Nos. of 400/220 kV ICT b) 3 Nos. of 220 kV Line c) 1 No. Bus coupler and 1 No. Transfer bus coupler d) Provision for 01 No. future Line bays.

(iii) Bay configuration at 765 kV Bikaner-IV S/s shall be such that one feeder in a diameter shall be terminated to a ICTs and other shall be terminated to lines / Bus Reactors. Accordingly, 04 Nos. complete diameter and 02 Nos. half diameter (consisting of Main and associated Tie bays) with a provision of 02 Nos. future bays (for terminating 765 kV (2nd D/C circuit) Bikaner-IV to Siwani D/C line) shall be under present scope.

B.2.0 Substation Equipment and facilities:

The switchgear shall be designed and specified to withstand operating conditions and duty requirements. All equipment shall be designed considering the following capacity.

Central Transmission Utility of India Limited

Bikaner A Power Transmission Limited

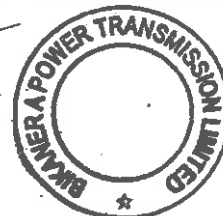
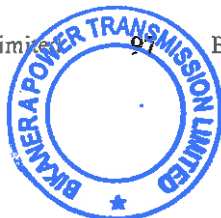
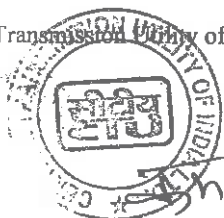

Sl. No	Description of bay	765/400/220 kV Bikaner-IV S/s			Extn. of 765 kV Siwani S/s
		765 kV	400 kV	220 kV	
1.	Bus Bar	4000 A	4000 A	3000 A	4000 A
2.	Line bay	3150 A	3150 A	1600 A	3150 A
3.	ICT bay	3150 A	3150 A	1600 A	--
4.	Bus Reactor Bay	3150 A	3150 A	--	--
5.	Switched Line Reactor Bay	3150 A	--	--	3150 A
6.	STATCOM bay	--	3150 A	--	--
7.	Bus Coupler Bay	--	--	3000 A	--
8.	Bus Sectionalizer Bay	--	--	4000 A	3000 A

Sl. No	Description of bay	Extn. of 400 kV Siwani s/s	Extn. of 400 kV Fatehabad (PG) S/s	Extn. of 400 kV Patran (Indi Grid) S/s
		400 kV	400 kV	400 kV
1.	Bus Bar	4000 A	Existing	Existing
2.	Line bay	3150 A	3150 A	3150 A
3.	Switched Line Reactor Bay	3150 A	--	--

B.2.1 (765/√3)/(400/√3)/33 kV, Single Phase Autotransformer

Central Transmission Utility of India Limited

98

Bikaner A Power Transmission Limited

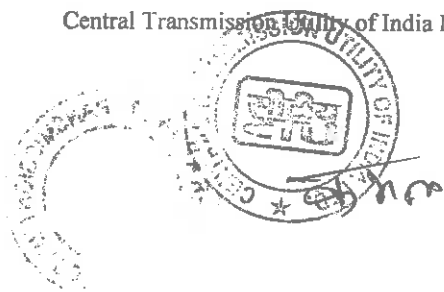

163

500 MVA, $(765/\sqrt{3}) / (400/\sqrt{3})/33$ kV, 1-phase Autotransformer (including arrangement for 3-phase bank formation of 1500 MVA) shall conform to CEA's "Standard Specifications and Technical Parameters for Transformers and Reactors (66 kV and above Voltage Class)" available on CEA website and as amended up to date.

Spare 1-phase Transformer unit shall be placed and connected in such a way that in case of fault in any unit of any of the transformer banks (including for future transformer banks) can be replaced by spare unit without physically moving it.

B.2.2 400/220 kV Autotransformer

500 MVA 400/220 kV, 3-phase Transformer shall conform to CEA's "Standard Specifications and Technical Parameters for Transformers and Reactors (66 kV and above Voltage Class)" available on CEA website and as amended up to date.

B.2.3 $(765/\sqrt{3})$ kV, Single Phase Shunt Reactor

80 MVAR, $765/\sqrt{3}$ kV, 1-Phase Reactor (including arrangement for 3-phase bank formation of 240 MVAR) shall conform to CEA's "Standard Specifications and Technical Parameters for Transformers and Reactors (66 kV and above Voltage class)" available on CEA website and as amended up to date.

Spare 1-phase Shunt Reactor unit shall be placed and connected in such a way that the spare unit can be utilized for all the bus and switchable line reactor banks (including for future reactor banks) without its physical movement.

The resistive value of NGR for each circuit at each end of 765 kV D/C Bikaner-IV – Siwani shall be considered 450 ohm.

Neutral Grounding Reactor and Surge Arrester for 765 kV Switchable Line Reactors (as applicable):

The neutral of the switchable line reactors (wherever provided) shall be grounded through adequately rated Neutral Grounding Reactors (NGR) to facilitate single phase auto-reclosure, provided that the NGR shall be provided with suitable bypass arrangement so that the switchable line reactor can be used as bus reactor as and when required. The neutral of bus reactor shall be solidly grounded.

NGR shall be oil filled or dry type air core for outdoor application. NGR shall conform to CEA's "Standard Specifications and Technical Parameters of Transformers and Reactors (66 kV and above Voltage Class)" as amended up to date. Technical parameters of NGR shall be as specified in Annexure-A of above-mentioned document.

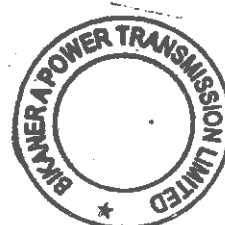

The surge arresters (rated voltage of arrester in co-ordination with ohmic value of NGR shall be decided by the TSP) shall be provided and physically located between the neutral of shunt reactor (brought out at 145 kV class bushing) and neutral grounding reactor. The surge arresters shall be of heavy duty station class gapless Metal oxide (ZnO) type conforming in general to IEC-60099-4. Surge Arresters shall be hermetically sealed units, of self-supporting construction, suitable for mounting on structures.

B.2.4 420 kV, 3-phase, Shunt Reactor

125 MVAR, 420 kV, 3-Phase Reactor shall conform to CEA's "Standard Specifications and Technical Parameters for Transformers and Reactors (66 kV and above Voltage Class)" available on CEA website and as amended up to date.

80 MVAR, 420 kV, 3-Phase Reactor shall conform to CEA's "Standard Specifications and Technical Parameters for Transformers and Reactors (66 kV and above Voltage Class)" available on CEA website and as amended up to date.

The resistive value of NGR for each circuit at Siwani end of 400 kV D/C Siwani-Patran (Indi Grid) line shall be considered 300 Ohm.

B.2.5 765 kV, 400 kV and 220 kV AIS Substation equipment (as applicable)

B.2.5.1 Circuit Breakers (AIS)

The circuit breakers and accessories shall conform with IEC: 62271-100, IEC: 62271-1 and shall be of SF6 Type. The circuit breakers shall be of class C2-M2 (as per IEC) with regard to restrike probability during capacitive current breaking and mechanical endurance. The rated break time shall not exceed 40 ms for 765 kV and 400 kV circuit breakers and 60 ms for 220 kV circuit breakers. 765 kV, 400 kV and 220 kV Circuit breakers shall be provided with single phase and three phase auto reclosing. Each breaker would have two sets of trip circuits which would be connected to separate DC supplies for greater reliability. The Circuit breakers controlling 765 kV lines shall be provided either with pre-insertion closing resistor of about 450 ohm maximum with 9 ms insertion time or with Controlled Switching Device. The Circuit breakers controlling 400 kV lines shall be provided with pre insertion closing resistor of about 400 ohm with 8 ms insertion time or Controlled Switching Device (CSD) for lines longer than 200 km. The short line fault capacity shall be same as the rated capacity and this is proposed to be achieved without use of opening resistors. The controlled switching device shall be provided in Circuit breakers of switchable line reactor and in Main and Tie circuit breakers of line with non-switchable line reactors, bus reactors and Transformers of voltage class 400 kV and above.

B.2.5.2 Isolators (AIS)

The isolators shall comply with IEC 62271-102 in general. 765 kV Isolator design shall be double break or vertical break or knee-type. 400 kV and 220 kV Isolators shall be

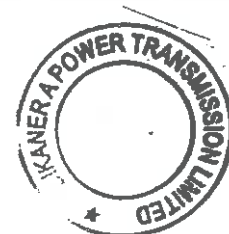
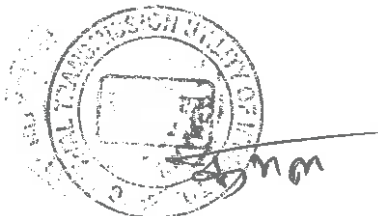

165

double break type. All isolators and earth switches shall be motor operated. Earth switches shall be provided at various locations to facilitate maintenance. Isolator rated for 400 kV and 220 kV shall be of extended mechanical endurance class - M2 as per IEC-62271-102. Isolator rated for 220 kV shall be suitable for bus transfer current switching duty as per IEC-62271-102. Main blades and earth blades shall be interlocked and interlock shall be fail safe type. 765 kV, 400 kV and 220 kV earth switches for line isolator shall be suitable for induced current switching duty as defined for Class-B.

B.2.5.3 Current Transformers (AIS)

Current Transformers shall comply with IEC 61869 in general. All ratios shall be obtained by secondary taps only. Generally, Current Transformers (CT) for 765 kV and 400 kV shall have six cores (four for protection and two for metering) and 220 kV Current Transformers shall have five cores (four for protection and one for metering). The burden and knee point voltage shall be in accordance with the requirements of the system including possible feeds for telemetry. Accuracy class for protection core shall be PX and for metering core it shall be 0.2S. The rated burden of cores shall be closer to the maximum burden requirement of metering and protection system (not more than 20 VA for metering core) for better sensitivity and accuracy. The instrument security factor shall be less than 5 for CTs up to 400 kV and less than 10 for CTs of 765 kV voltage class.

B.2.5.4 Capacitive Voltage Transformers (AIS)

Capacitive Voltage transformers shall comply with IEC 61869 in general. These shall have three secondaries out of which two shall be used for protection and one for metering. The accuracy class for protection cores shall be 3P and for metering core shall be 0.2. The capacitive voltage transformers on lines shall be suitable for Carrier Coupling. The Capacitance of CVT for 400 kV and 220 kV shall be of 4400/8800 pF depending on PLCC requirements whereas the Capacitance of CVT for 765 kV shall be 8800 pF. The rated burden of cores shall be closer to the maximum burden requirement of metering and protection system (not more than 50 VA for metering core) for better sensitivity and accuracy.

B.2.5.5 Surge Arresters (AIS)

624 kV, 336 kV Station High (SH) duty and 216 kV Station Medium (SM) duty gapless type Surge arresters with thermal energy (W_{th}) of minimum 13 kJ/kV, 12 kJ/kV and 7 kJ/kV conforming to IEC 60099-4 in general shall be provided for 800 kV, 420 kV and 245 kV systems respectively. Other characteristics of Surge arrester shall be chosen in accordance with system requirements. Surge arresters shall be provided at line entrances, near transformers and reactors to achieve proper insulation coordination. Surge Arresters shall be provided with porcelain/ polymer housing fitted with pressure relief devices. A leakage current monitor with surge counter shall be provided with each surge arrester.

B.2.6 400 kV GIS Substation equipment (as applicable)

Central Transmission Utility of India Limited

101

Bikaner A Power Transmission Limited

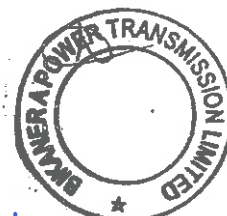
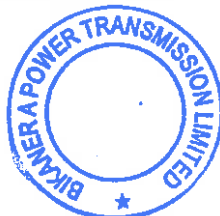
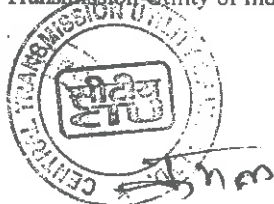

166

GIS (Gas Insulated Switchgear) shall be Indoor type in accordance with IEC : 62271-203. The switchgear shall be designed and specified to withstand operating conditions and duty requirements. All the switchgear such as circuit breaker, isolator, earth switch including CT, PT etc. shall be GIS type. The Surge Arrestor and Voltage Transformer shall be either GIS or outdoor AIS type.

The GIS assembly shall consist of separate modular compartments e.g. Circuit Breaker compartment, Bus bar compartment filled with SF6 Gas and separated by gas tight partitions so as to minimize risk to human life, allow ease of maintenance and limit the effects of gas leaks failures and internal arcs etc. These compartments shall be designed to minimize the risk of damage to adjacent sections and protection of personnel in the event of a failure occurring within the compartments. Rupture diaphragms with suitable deflectors shall be provided to prevent uncontrolled bursting pressures developing within the enclosures under worst operating conditions, thus providing controlled pressure relief in the affected compartment. The arrangement of gas sections or compartments shall be such as to facilitate future extension of any make without any drilling, cutting or welding on the existing equipment. To add equipment, it shall not be necessary to move or dislocate the existing switchgear bays. The layout of Gas Insulated Bus Ducts shall be properly planned to optimize the length of bus ducts and for easy accessibility for maintenance. The length of busbars, bus ducts, isolator sections shall be optimized considering effects of fast transient voltage due to isolator operations.

The bus bar modules including auxiliary bus modules (wherever applicable) shall be provided with suitable End Piece (Interface) module on both sides with the test link facility for future extension as per provisions of future requirements. The end piece module shall be designed in such a way so that future GIS modules may be tested without extending test voltage to existing bus and vice-versa by removing the test link.

TSP shall make available the complete details for the design of interface module such as cross section, enclosure material, enclosure dimensions (inner and outer), Flange diameter (inner and outer), conductor cross-section and connection arrangement, bolt spacing and dimension, rated gas pressure, Gasket detail etc. Further, adequate space for GIS busbar interface module shall be taken into account for future scope.

Each section shall have plug-in or easily removable connection pieces to allow for easy replacement of any component with the minimum disturbance to the remainder of the equipment. Inspection windows (View Ports) shall be provided for Disconnecter Switches and both type of earth switches i.e. Maintenance and fast operating.

Local Control Cabinets (LCC) shall be provided as per requirement. The alarm and annunciation of GIS equipment shall be wired to the SCADA System.

The material and thickness of the enclosures shall be such as to withstand an internal flashover without burns through for a period of 300 ms at rated short time withstand

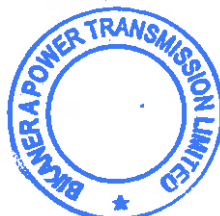
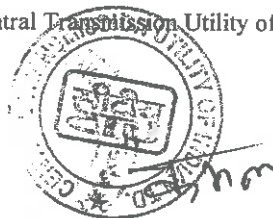

A

167



current. The material shall be such that it has no effect of environment as well as from the by-products of SF6 breakdown under arcing condition. This shall be validated with Type Test.

Service continuity requirement for GIS:

The GIS equipment with the given bus switching arrangement shall be divided into different gas compartments. During the work such as a fault repair or major maintenance, requiring the dismantling of a gas compartment for which more than one compartments may need to be de-gassed.

TSP shall meet following the Service continuity conditions (to the extent possible) with ensuring equipment and operating personnel's safety:

- For One and half breaker bus switching scheme, during a fault in Circuit Breaker compartment, no bus bar and feeder is permitted out of service during maintenance and repair/replacement.
- For Double Main bus switching scheme, during a fault in Circuit Breaker compartment, no bus bar is permitted out of service during maintenance and repair/replacement.
- During a fault in a GIS compartment other than the Circuit Breaker compartment, maximum one bus bar and/or one feeder is permitted out of service during maintenance and repair/replacement.

UHF sensors in GIS for PD (Partial Discharge) detection:

The adequate number of Ultra High Frequency (UHF) sensors shall be provided in the offered GIS along with suitable portable type Partial Discharge (PD) measuring instruments for detection of Partial discharge (of 5 pC and above as per IEC 60270). The number and location of these sensors shall be based on laboratory tests on typical design of GIS as per recommendations of CIGRE Document No. 654 (Application Guide for sensitivity verification for UHF Partial discharge detection system for GIS).

B.2.6.1 CIRCUIT BREAKERS (GIS)

GIS Circuit breakers shall in general be of C2-M2 class and comply with IEC-62271-100. The rated break time shall not exceed 40 ms for 400 kV. Circuit breakers shall be provided with single phase and three phase auto reclosing. Each breaker shall have two set of trip circuits which would be connected to separate DC supplies for greater reliability. The Circuit breakers controlling 400 kV lines wherever required shall be provided with pre-insertion closing resistor of about 400 ohms with 8 ms insertion time or Controlled Switching Device (CSD) for lines longer than 200 km. The short line fault

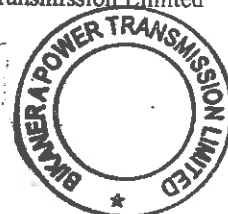
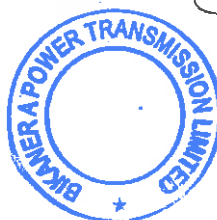
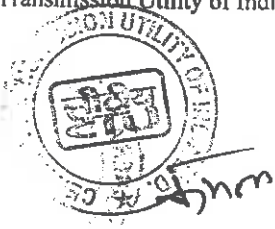

capacity shall be same as the rated capacity and this is proposed to be achieved without use of opening resistors. Control switching device shall be provided in Circuit Breaker of switchable line reactor bay and in Main and Tie bay circuit breakers of line with non-switchable line reactors, bus reactors and transformers.

B.2.6.2 ISOLATORS (GIS)

The isolators shall comply with IEC 62271-102 in general. Earth switches shall be provided at various locations to facilitate maintenance. Main blades and earth blades shall be interlocked and interlock shall be fail safe type. All isolators and earth switches shall be motor operated type.

The isolator shall be of extended mechanical endurance class-M2 as per IEC standard. High speed earthing switches shall be provided for grounding purpose at overhead line terminations and cable terminations and shall have fault making capability as specified. Earth switch for line isolator shall be of earthing switch class E1 and shall be suitable for induced current switching duty as defined for Class-B as per relevant standard.

B.2.6.3 CURRENT TRANSFORMERS (GIS)

Current Transformers shall comply with IEC 61869 in general. All ratios shall be obtained by secondary taps only. For 400 kV and above voltage class, generally Current Transformers (CT) shall have five cores (four for protection and one for metering) whereas; CT in Tie bays shall have six cores (four for protections and two for metering) suitably distributed on both sides of CB. The burden and knee point voltage shall be in accordance with the requirements of the system including possible feeds for telemetry. The accuracy class for protection core shall be PX and for metering core it shall be 0.2S. The rated burden of cores shall be closer to the maximum burden requirement of metering and protection system (not more than 20 VA for metering core) for better sensitivity and accuracy.

The instrument security factor shall be less than 5 for CTs up to 400 kV voltage class.

B.2.6.4 VOLTAGE TRANSFORMERS (GIS)

The voltage transformers shall conform to IEC-61869. Voltage transformers shall be of electromagnetic type with SF6 gas insulation. The earth end of the high voltage winding and the ends of the secondary winding shall be brought out in the terminal box. The voltage transformers shall be located as a separate bay module and will be connected phase to ground and shall be used for protection, metering and synchronization. The voltage transformers shall be of inductive type, nonresistant and shall be contained in

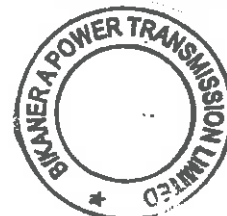
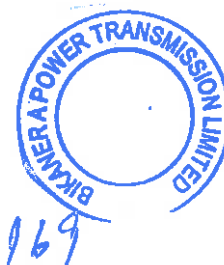

their own-SF₆ compartment, separated from other parts of installation. The voltage transformer shall be effectively shielded against high frequency electromagnetic transients. The voltage transformer shall have three secondary windings out of which two shall be used for protection and one for metering. The voltage transformer should be thermally and dielectrically safe when the secondary terminals are loaded with the guaranteed thermal burdens. The accuracy class for protection cores shall be 3P. The accuracy of 0.2 on metering core should be maintained throughout the entire burden range on all the three windings without any adjustments during operation. The rated burden of cores shall be closer to the maximum burden requirement of metering and protection system (not more than 50 VA for metering core) for better sensitivity and accuracy.

B.2.6.5 SURGE ARRESTERS (GIS)

336 kV Station High (SH) duty gapless type Surge arresters with thermal energy (W_{th}) of minimum 12 kJ/kV conforming to IEC 60099-4 in general shall be provided for 420 kV. Other characteristics of Surge arrester shall be chosen in accordance with system requirements. Surge arresters shall be provided at line entrances, near transformers and reactors to achieve proper insulation coordination. Surge Arresters shall be provided with porcelain/ polymer housing fitted with pressure relief devices. A leakage current monitor with surge counter shall be provided with each surge arrester.

B.2.6.6 SF₆ TO AIR BUSHING

Outdoor bushings, for the connection of conventional external conductors to the SF₆ metal enclosed switchgear, shall be provided. Bushings shall generally be in accordance with the requirements of IEC-60137. The creepage distance over the external surface of outdoor bushings shall not be less than 31 mm/kV. SF₆ to air Bushing shall be of Polymer/ composite type and shall be robust and designed for adequate cantilever strength to meet the requirement of seismic conditions. The electrical and mechanical characteristics of bushings shall be in accordance with IEC 60137. Polymer/composite insulator shall be seamless sheath of silicon rubber compound. The housing and weather sheds should have silicon content of minimum 30% by weight. It should protect the bushing against environmental influences, external pollution and humidity. The hollow silicon composite insulators shall comply with the requirements of IEC 61462 and the relevant parts of IEC 62217.

B.2.7 Protection Relaying and Control System

The protective relaying system proposed to be provided for transmission lines, auto-transformers, reactors and bus bars to minimize the damage to the equipment in the

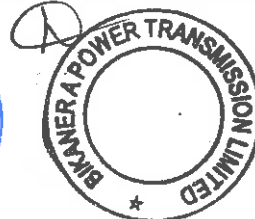
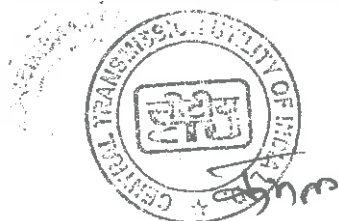

events of faults and abnormal conditions, is dealt in this section. All main protective relays shall be numerical type with IEC 61850 communication interface and should have interoperability during integration of numerical relays to communicate over IEC61850 protocol with RTU/SAS/IEDs of different OEMs. All numerical relays shall have built in disturbance recording feature.

The protection circuits and relays of the transformer and reactor shall be electrically and physically segregated into two groups each being independent and capable of providing uninterrupted protection even in the event of one of the protection groups failing, to obtain redundancy, and to take protection systems out for maintenance while the equipment remains in service.

a) Transmission Lines Protection

765 kV, 400 kV and 220 kV shall have Main-I numerical three zone distance protection scheme with carrier aided inter-tripping feature. 765 kV, 400 kV and 220 kV lines shall also have Main-II numerical distance protection scheme like Main-I but from different make that of Main-I. The Main-I and Main-II protection relays of same make may be provided only if they are of different hardware and manufacturing platform or different principle of operation.

However, Line Current Differential relay (with back up distance protection feature) as Main-I and Main-II shall be considered at both ends for short lines (line length below 30 km) having Fiber Optic communication link. Differential relay at remote end shall be provided by the TSP. Associated power and control cabling and integration with SAS at remote end shall be provided by respective bay owner.

Further, all 765 kV, 400 kV and 220 kV lines shall be provided with single and three phase auto-reclosing facility to allow reclosing of circuit breakers in case of transient faults. These lines shall also be provided with distance to fault locators to identify the location of fault on transmission lines.

All 765 kV and 400 kV lines shall also be provided with two stages over voltage protection. Over voltage protection and distance to fault locator may be provided as in-built feature of Main-I and Main-II protection relays. Auto reclose as built-in function of Bay Control Unit (BCU) is also acceptable.

The Main-I and Main-II protection relays shall be fed from separate DC sources and shall be mounted in separate panels.

For 765 kV, 400 kV and 220 kV transmission lines, directional IDMT earth fault relay should be provided as standalone unit or in-built feature of Main-I and Main-II feature. In case of 220 kV line bays where the line lengths are not indicated, Numerical Distance protection relay as Main-I and Line Current differential relay (with back up distance protection feature) as Main-II shall be provided. Further, in such case, the matching line current differential relay for remote end shall be provided by the remote end bay owner. In case of loop in loop out of transmission lines, the existing protection scheme shall be studied and suitable up-gradation (if required) shall be carried out.

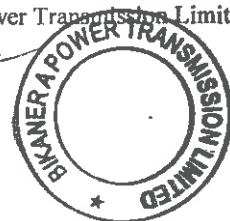
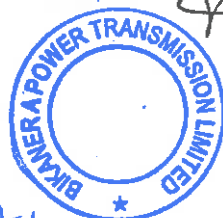
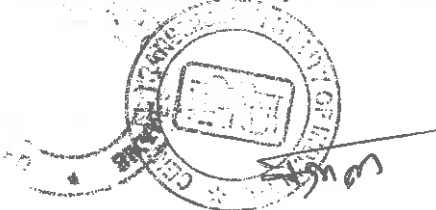

b) Auto Transformer Protection

These shall have the following protections:

- i) Numerical Differential protection
- ii) Numerical Restricted earth fault protection
- iii) Numerical Back-up Over-current and earth fault protection on High Voltage (HV) and Intermediate Voltage (IV) side
- iv) Numerical Over fluxing protection on HV and IV side
- v) Numerical Overload alarm

Further, Numerical Back-up Over-current and earth fault protection on HV and IV side of autotransformer shall not be combined with other protective functions in the main relays and shall be independent relays. Besides these, power transformers shall also be provided with Buchholz relay, Magnetic Oil Gauge (MOG) with low oil level alarm, protection against high oil and winding temperature and pressure relief device etc. Suitable monitoring, control (operation of associated circuit breaker and isolator) and protection for LT auxiliary transformer connected to tertiary winding of auto-transformer for the purpose of auxiliary supply shall be provided. The over current and other necessary protection shall be provided for the auxiliary transformer. These protection and control may be provided as built in feature either in the bay controller to be provided for the auxiliary system or in the control and protection IEDs to be provided for autotransformer.

c) 765 kV and 400 kV Reactor Protection

Reactor shall be provided with the following protections:

- i) Numerical Differential protection.
- ii) Numerical Restricted earth fault protection
- iii) Numerical Back-up impedance protection

Besides these, reactors shall also be provided with Buchholz relay, Magnetic Oil Gauge (MOG) with low oil level alarm, protection against oil and winding temperatures and pressure relief device, etc.

d) Bus bar Protection

The high-speed low impedance type bus bar differential protection, which is essential to minimize the damage and maintain system stability at the time of bus bar faults, shall be provided for 765 kV, 400 kV and 220 kV buses. Duplicated bus bar protection is envisaged for 765 kV and 400 kV bus-bar protection. Bus bar protection scheme shall

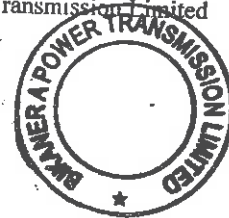
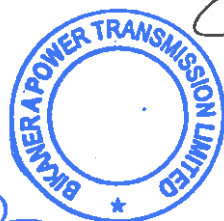
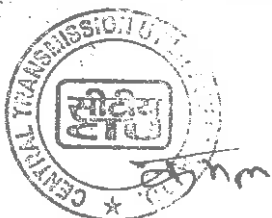

be such that it operates selectively for each bus and incorporate necessary features required for ensuring security. The scheme shall have complete bus bar protection for present as well as future bays envisaged i.e. input / output modules for future bays shall also be provided.

Bus Bar protection system for new substation shall be de-centralized (distributed) type. In case, the bus section is provided, then each side of bus section shall have separate set of bus bar protection schemes.

For existing substations, the existing bus bar protection shall be augmented as per requirement.

e) Local Breaker Back up Protection

This shall be provided for each 765 kV, 400 kV and 220 kV circuit breakers and will be connected to de-energize the affected stuck breaker from both sides.

Notes:

- 1. LBB and REF relays shall be provided separately from transformer differential relay.*
- 2. LBB relay may also be provided as built-in protection function of distributed bus bar protection scheme; however, in such case separate LBB relay shall be provided for tie bays (in case of One and Half breaker scheme).*
- 3. Over fluxing and overload protection can be provided as built-in feature of differential relay.*
- 4. In 765 kV and 400 kV switchyard, if spure bay of half diameter is identified as future, Tie CB relay panel shall be with Auto-reclosure feature.*

B.2.8 Substation Automation System

- a) For all the new substations, state-of-art Substation Automation System (SAS) conforming to IEC-61850 shall be provided. The distributed architecture shall be used for Substation Automation system, where the controls shall be provided through Bay control units. The Bay control unit is to be provided bay wise for voltage level 220 kV and above. All bay control units as well as protection units are normally connected through an Optical fibre high speed network. The control and monitoring of circuit breaker, dis-connector, re-setting of relays etc. can be done from Human Machine Interface (HMI) from the Control Room.

The functions of control, annunciation, disturbance recording, event logging and measurement of electrical parameters shall be integrated in the Substation Automation System.

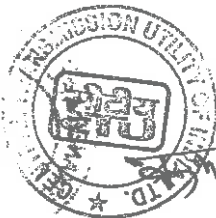

Handwritten mark resembling the number 2.

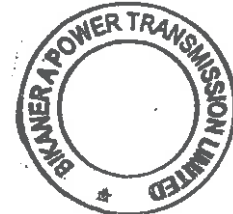

At new substations, the Substation Automation System (SAS) shall be suitable for the operation and monitoring of the complete substation including proposed future bays elements.

In existing substations with a Substation automation system (SAS), augmentation of existing SAS shall be done for bays under the present scope.

In the existing Substations where Substation automation is not provided, control functions shall be done through control panels.

Necessary gateway and modems (as required) shall be provided to send data to RLDC/SLDC as per their requirement and shall be provisioned with 2+2 redundancy i.e. 2 channels for Main Control Centre and 2 channels for Backup Control Centre. In order to meet this requirement, suitable redundancy at port and card level need to be ensured by the TSP to avoid any single point of failure which may lead to interruption in real-time grid operation. Accordingly, all the hardware for communication services of station as stated above shall support dual redundancy for data transmission of station to respective main and backup RLDCs. Any augmentation work at RLDC/SLDC is excluded from TSP's scope. However, all the configuration work at substation end required to send data to RLDC/SLDC shall be in the scope of TSP.

b) Time Synchronisation Equipment

Time synchronization equipment complete in all respect including antenna, cable and processing equipment required to receive time signal through GPS or from National Physical Laboratory (NPL) through INSAT shall be provided at new substations. This equipment shall be used to synchronize SAS and IEDs etc.

B.3.0 Substation Support Facilities

Certain facilities required for the operation and maintenance of substations as described below shall be provided at the new substation. In existing substation, these facilities have already been provided and will be extended/ augmented as per requirement.

B.3.1 AC and DC power supplies

For catering the requirements of three phase and single-phase AC supply and DC supply for various substation equipment (for present and future scope), the following arrangement is envisaged: -

- i) For LT Supply at each new Substation, two (2) Nos. of LT Transformers (minimum 800 kVA for substations with highest voltage rating as 765 kV) shall be provided

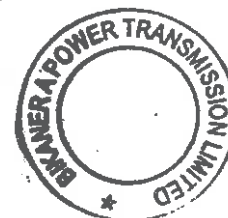
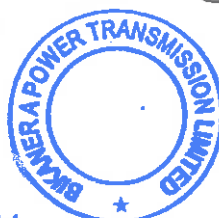

174

which shall be fed from two independent sources as per the CEA (Technical Standards for Connectivity to the Grid) Regulations, 2007.

Metering arrangement with Special Energy Meters (SEMs) shall be provided by TSP at 33 kV tertiary of Transformer for drawing auxiliary supply at new substation. Such SEMs shall be provided by CTU at the cost of the TSP. Accounting of such energy drawn by the TSP shall be done by /RPC as part of Regional Energy Accounting.

Additionally, Active Energy Meters may be provided at the same point in the 33 kV tertiary of Transformer by local SEB/DISCOM for energy accounting.

- ii) 2 sets of 220 V battery banks for control and protection and 2 sets of 48 V battery banks for PLCC/communication equipment shall be provided at each new Substation. Each battery bank shall have a float-cum-boost charger.

At new substation, sizing of 220 V battery and battery charger shall be done based on the number of bays specified (including future bays) as per CEA Regulations and relevant IS. Two (2) sets of 48 V battery banks for PLCC and communication equipment for present and future scope shall be provided at each new Substation with at least 10-hour battery backup and extended backup, if required. 48 V DC can be achieved from 220 V DC battery bank using adapter, if so desired by TSP, without compromising backup time.

- iii) Suitable AC and DC distribution boards and associated LT Switchgear shall be provided at new substation.

For new substation, following switch boards shall be considered with duplicate supply with bus coupler/ sectionalizer and duplicate outgoing feeders except for Emergency lighting distribution board which shall have only one incoming feeder:

- (a) 415 V Main Switch board – 1 No.
- (b) AC distribution board – 1 No.
- (c) Main lighting distribution board – 1 No.
- (d) Emergency lighting distribution board – 1 No.
- (e) 220 Volt DC distribution board – 2 Nos.
- (f) 48 Volt DC distribution board – 2 Nos.

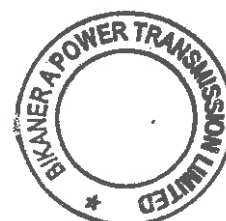
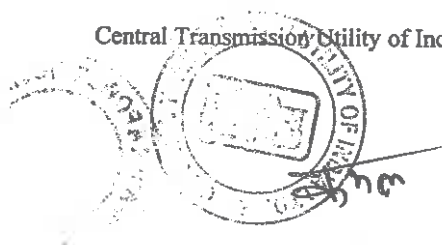

Sizing of LT Switchgear shall be suitable to cater the requirement for all present and future bays. AC and DC distribution boards shall have modules for all the feeders (including future as specified).

iv) At new Substation, one No. of DG set (minimum 500 kVA for substations with highest voltage rating as 765 kV) shall be provided for emergency applications.

v) At new substation, sizing of battery and battery charger shall be done based on the number of bays specified (including future bays).

vi) For substation extensions, existing facilities shall be augmented as required.

B.3.2 Fire Fighting System

Fire-fighting system for substation including Transformer and Reactor shall conform to CEA (Measures Relating to Safety and Electric Supply) Regulations, 2023 as amended from time to time.

Further, adequate water hydrants and portable fire extinguishers shall be provided in the substations. The main header of the firefighting system shall be suitable for extension to bays covered under the future scope; necessary piping interface in this regard shall be provided.

Optical Beam type heat detection for GIS hall fire protection system shall be provided in all the GIS halls.

At existing substations, the fire-fighting systems as available shall be extended to meet the additional requirements.

B.3.3 Oil evacuating, filtering, testing and filling apparatus

To monitor the quality of oil for satisfactory performance of Transformers, Shunt Reactors and for periodical maintenance necessary oil evacuating, filtering, testing and filling apparatus would be provided at new substations. Oil storage tanks of adequate capacities for storage of transformer oil would be provided.

Online Transformer Oil Drying Out System shall be provided in line with the provisions of Standard Specification and Technical Parameters for Transformers and Reactors (66 kV and above Voltage Class) as amended up to date available on CEA website.

B.3.4 Illumination

Central Transmission Utility of India Limited

111

Bikaner A Power Transmission Limited

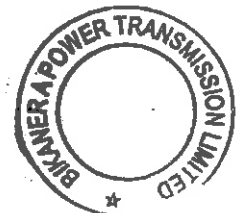

176

Normal and emergency AC and DC illumination shall be provided adequately in the control room and other buildings of the substation. The switchyard shall also be provided with adequate illumination.

The lighting of the entire control room building, fire-fighting pump house, other building (if any) and switchyard shall be done by LED based low power consumption luminaries.

B.3.5 Control Room

For the new substation, substation control room shall be provided to house substation work stations for station level control (SAS) along with its peripheral and recording equipment, AC and DC distribution boards, DC batteries and associated battery chargers, Fire Protection panels, Telecommunication panels and other panels as per requirements. Air conditioning shall be provided in the building as functional requirements. Main cable trenches from the control room shall have adequate space provision for laying of cables from the control room for all the future bays.

At existing substations, the adequacy of size of control room shall be ascertained and the same shall be augmented as per requirement.

B.3.6 GIS hall

The Gas Insulated Switchgear (GIS) of each voltage level along with other associated equipment shall be housed inside separate GIS building. The panels i.e. Bay level units, bay mimic, relay and protection panels, RTCC panels, PLCC panels, panels for telecommunication system etc. are to be placed in a separate room in the GIS building. The size of the room shall be such that all the panels for the bays under present scope shall be accommodated. The panel room shall be air-conditioned. Further, the temperature of the room shall be monitored through substation automation system by providing necessary temperature transducers. Ventilation system of suitable capacity shall be provided for each GIS hall.

One EOT Crane of suitable capacity for erection and Maintenance of largest GIS component/assembly and all plant installed in the GIS switchgear room shall be provided in each GIS hall. The crane shall be capable of fulfilling all special requirements for erection and maintenance of GIS equipment. The capacity of the crane shall be sized to lift the heaviest GIS switchgear component.

For extension of existing GIS, existing facilities shall be suitably augmented/ extended for GIS equipment under present scope.

B.3.7 Control Concept

All the EHV circuit breakers in substation/switching stations shall be controlled and synchronized from the switchyard control room/remote control center. All the isolators shall have control from remote/ local whereas the earth switches shall have local control only.

Central Transmission Utility of India Limited

Bikaner A Power Transmission Limited

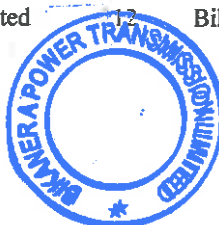
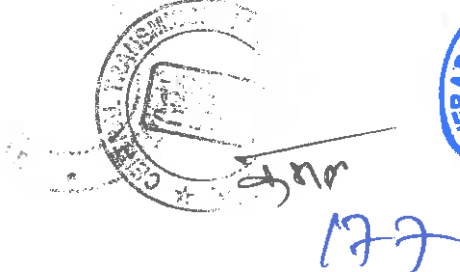

Handwritten signature in blue ink.

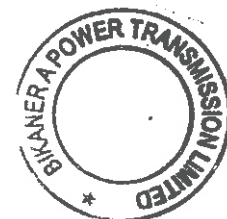

B.3.8 Visual monitoring system (VMS) for watch and ward of substation premises:

Visual monitoring system for effective watch and ward of substation premises shall cover all the transformers and reactors, all other major AIS Equipment (such as CB, isolators, CT, CVT, SA etc. as applicable), GIS bays, panel room, all the gates of switchyard and all entry and exit points of control room building and accordingly the location of cameras shall be decided. In addition to the gates of the switchyard, the cameras shall also be located around the boundaries at suitable locations. The camera shall be high definition color CCD camera with night vision feature. The VMS data partly/completely shall be recorded (minimum for 15 days) at least @25fps (or better) and stored on network video recorder. The system shall use video signals from various cameras installed at different locations, process them for viewing on workstations/monitors in the control room and simultaneously record all the cameras. The VMS data should go only to the intended personnel/facility and not to the remote server of the Camera (VMS supplier).

Mouse/keyboard controllers shall be used for pan, tilt, zoom and other functions of the desired camera. The Visual Monitoring System shall have provision of WAN connectivity for remote monitoring.

All camera recordings shall have Camera ID and location/area of recording as well as date/time stamp. The equipment should generally conform to Electromagnetic compatibility requirement for outdoor equipment in EHV substation.

At existing substations, the visual monitoring system if available shall be augmented as per existing or better specification as required.

B.4.0 General Facilities

- a) Line Gantry/Towers are envisaged for bays under present scope only. However, for adjacent future line bay, tower shall be designed for extension (considering Quad conductors for 765 kV and 400 kV future lines) wherever applicable.
- b) Bay extension works at existing substation shall be executed by TSP in accordance with the requirements/provisions mentioned above. However, interface points shall be considered keeping in view the existing design/arrangement at the substation.
- c) TSP has to arrange for construction power and water on its own.
- d) All outdoor steel structures including anchor/foundation bolts shall be fully galvanized. The weight of the zinc coating shall be at least 610 gm/m² and 900 gm/m² for coastal/ creek regions (if applicable).
- e) In 765 kV and 400 kV switchyard, if spare bay of half diameter is identified as future, all the equipment for Tie and Future Bay shall be designed considering the



178

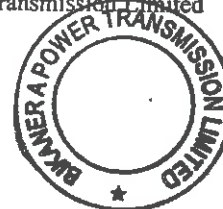

current rating of line bay i.e. 3150 A.

- f) Boundary wall shall be brick masonry wall with RCC frame or Stone masonry wall or Precast RCC wall under present scope along the property line of complete substation area including future switchyard area to prevent encroachment and unauthorized access. Minimum height of the boundary wall shall be of 1.8 m from finished ground level (FGL).
- g) All electrical equipment shall be installed above the Highest Flood Level (HFL) and where such equipment is not possible to be installed above HFL, it shall be ensured that there is no seepage or leakage or logging of water.
- h) As per CEA (Technical Standards for Construction of Electrical Plants and Electric Lines) Regulations, 2022 and CEA Manual on Transmissions Planning criteria 2023, Line approaching substation shall normally be perpendicular to the substation boundary for a stretch of 2-3 kms. Accordingly, TSP shall ensure that line terminations at substations are arranged in a manner to avoid hindrance to future line terminations at the substations.

B.5.0 EXTENSION OF EXISTING SUBSTATION

The following drawings/details of existing substation is attached with the RFP documents for further engineering by the bidder.

Sl. No.	Drawing Title	Drawing No./Details	Rev. No.
A.	400 kV Patran S/s		
1.0	Single Line Diagram	PTCL/STS/PATRAN/ELEC/DRG/001	R2
2.0	General Arrangement	PTCL/STS/PATRAN/ELEC/DRG/002	R3
3.0	Earthmat Layout	PTCL/STS/PATRAN/ELEC/DRG/38	R0
4.0	Visual Monitoring System	Make: ALCON	--
5.0	Bus Bar Protection	Make: ABB Model: REB 670	--
6.0	Substation Automation System (SAS)	Make: ABB Model: SAS 600	--
B.	400 kV Faehabad S/s		
1.0	Single Line Diagram	C/ENGG-SS/NR/FATEHABAD-EXT/SLD/01	00

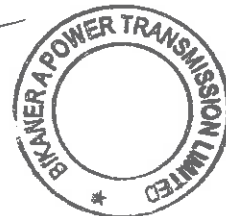
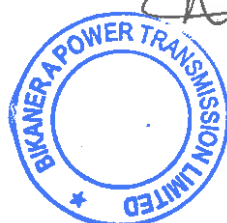

2.0	General Arrangement	C/ENGG-SS/NR/FATEHABAD-EXT/GA/01	00
3.0	Earthmat Layout	KEC-A770-771-FBD-02-5021	01
4.0	Visual Monitoring System	Make: ALSTOM(SCHINDER) CAMERA Make -PELCOM	--
5.0	Bus Bar Protection	Make: ABB Model: REB500	--
6.0	Substation Automation System (SAS)	Make: ABB make (Hitachi) Model: MICROSCADA 10.3	--

Bidder is advised to visit the substation sites and acquaint themselves with the topography, infrastructure such as requirement of roads, cable trench, drainage, space availability in control rooms and LT panel room etc. and also the design philosophy.

Central Transmission Utility of India Limited

115

Bikaner A Power Transmission Limited

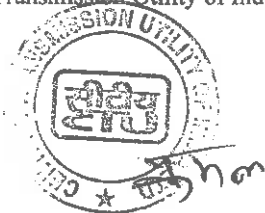

180

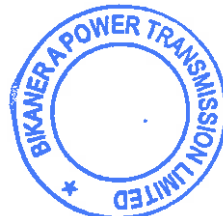

SPECIFIC TECHNICAL REQUIREMENTS FOR STATCOM

The proposed STATCOMs shall be generally conforming to the requirements of CEA (Technical Standards for Connectivity to Grid) Regulations, 2007 including amendments and CEA (Technical Standards for Construction of Electrical Plants and Electric Lines) Regulations 2022, as amended from time to time. Other CEA Regulations and MoP guidelines, as applicable, shall also be followed and complied with.

C.1 Introduction:

This technical specification for a STATCOM Station consists of STATCOM, Mechanically Switched Capacitors (MSCs) and Mechanically Switched Reactors (MSRs) (to be installed at MV bus) including associated coupling Transformer (rated 400/xx kV) and other equipment connected to the 400 kV bus. MV voltage level (xx kV) of the coupling Transformer can be chosen by the TSP to optimize the offered solution which meets functional requirement of this Technical Specification.

The STATCOM station shall operate asymmetrically in the leading and lagging MVAR regions as applicable to reach the dynamic range specified. The purpose of the STATCOM station is to regulate the voltage of 400 kV Bus Point of Common Coupling (PCC). The Configuration and the nominal rating of the STATCOM station is specified in this document.

The main building block of the STATCOM should be single phase Voltage Source Converter (VSC) based convertor valve (multi-level) operating in a way to eliminate or minimize AC filter requirement to High pass filter only and connected to the xx kV bus through air core reactors.

C.1.1 Definitions and Abbreviations

For the purpose of this specification, the following definitions / abbreviations are used:

PCC: Point of Common Coupling (herein also called as Point of Interconnection (POI)). The connection point between the STATCOM and ISTS at which performance requirements are defined.

Reference Voltage (Vref): The Point on the voltage/current (V/I) characteristics where the static synchronous compensator (STATCOM) is at zero output (i.e. where no reactive power is absorbed from, or supplied to, the transmission system where the voltage is controlled)

MV: Medium Voltage.



181

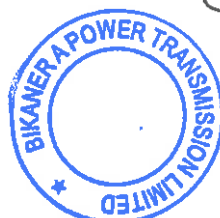

Handwritten signature

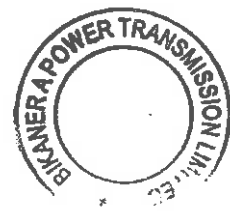

STATCOM Unit: Static Synchronous Compensator based on Multi-Module technology and including air cored reactors as needed. Valve cooling, switchgear and its control and protection.

STATCOM: Static Synchronous Compensator consisting of STATCOM Unit(s) connected to a common coupling Transformer. A static synchronous generator operated as a shunt connected compensator, whose capacitive or inductive output current can be controlled independently of the AC system voltage.

MSC: Mechanically Switched Capacitor (Including Switchgear). A shunt-connected circuit containing a mechanical power-switching device in series with a capacitor bank and a current limiting reactor.

MSR: Mechanically Switched Reactor (Including Switchgear). A shunt-connected circuit containing a mechanical power-switching device in series with a reactor.

Sub Module: Basic single power module of a Multi Module STATCOM unit Valve. It is a Part of a STATCOM unit valve comprising controllable switches and diodes connected in full bridge arrangement, together with their immediate auxiliaries, and storage capacitor, if any, where each controllable switch consists of one or more switched valve device(s) connected in series.

Valve: Electrically and mechanically combined assembly comprising of forced commutated devices [for example insulated-gate bipolar transistor(IGBT)] assembled in levels, complete with all connections, auxiliary components, and mechanical structures, which can be connected in series with each phase of the reactor of a STATCOM unit.

Valve Section: Electrical assembly defined for test purposes, comprising one of several sub-modules.

Valve Structure: Physical structure holding valve(s), which is insulated to the full system voltage above earth potential.

STATCOM Station: STATCOM Station includes 400 kV Switchgear, Coupling Transformer, STATCOM, MSCs (as applicable), MSRs (as applicable) along with its switchgear and complete integrated control and protection whose outputs are coordinated. (Complete turnkey delivery at site).

CT: Current Transformer.

VT: Voltage Transformer.

SAS: Substation Automation System.

Response Time: The duration from a step change in control signal until the voltage changes by 90% of its final change, before any overshoot.

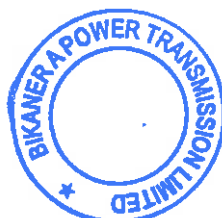
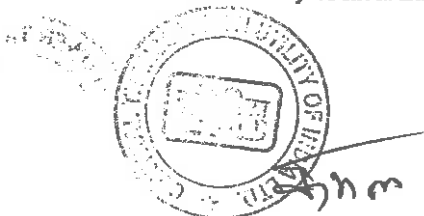

Handwritten signature

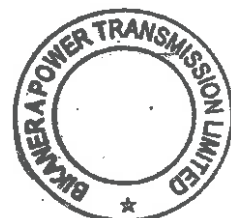

Settling Time: The duration from a step change in control signal input until the STATCOM output settles to within $\pm 5\%$ of the required control output.

Slope: The ratio of the voltage change to the current change over a defined controlled range of the STATCOM, normally the full (inductive plus capacitive) range at nominal voltage, expressed as a percentage.

VSC: Voltage Source Converter, A forced commutated device (for example, IGBT) based self-commutated convertor that is capable of generating AC voltage from DC capacitor.

Voltage/Current (V/I) Characteristic: The relationship between the current of the STATCOM and the voltage at the point of connection.

Lagging Operation: Inductive operation or reactive power absorption of the STATCOM similar to a shunt reactor.

Leading Operation: Capacitive operation or reactive power generation of the STATCOM similar to a shunt Capacitor.

TSP: Transmission Service Provider

C.2

Relevant Standard:

STATCOM Station shall comply with the following standards (latest edition):

Sl. No.	Description	Standards
1	Voltage source converter (VSC) valves for STATCOM	IEC- 62927 IEEE- 1052 IEC-60747
2	Control, protection and monitoring	IEC-61000 IEC-60255
3	Valve Hall for housing the equipment as above comprising of: <ul style="list-style-type: none"> - wall bushings for connection between converter phases and decoupling reactors, - piping and tubing connections of the cooling system to converter - connection of the control cabinet with the converter through optical fibers - internal lighting, auxiliary power supply (AC and DC) and power socket system - internal HVAC system 	IEC-60071 IEC-60270 IEC-60137
4	X kV, dry insulated, air core and air self-cooled decoupling reactors.	IEC- 60076



183

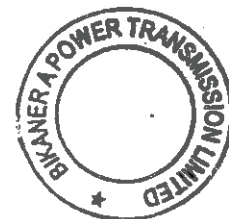
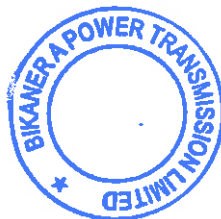

Sl. No.	Description	Standards
	Mechanically Switched Reactors, half-reactors stacked on above the other, Outdoor installation. Complete with supporting structures	
5	Power Capacitors (MSC etc.)	IEC-60871-1
6	400 kV Power transformer (Coupling Transformer)	IEC-60076 IEC-60354
7	CT's and VT's	IEC- 61869
8	Dis-connectors and Earthing Switches	IEC- 62271
9	HV and MV Circuit Breakers	IEC- 62271
10	Surge Arresters	IEC- 60099
11	Auxiliary and grounding transformer	IEC- 60076 IEEE C57.32 IS- 5553 (Part 6)
12	Neutral Grounding Resistor, charging resistor	IEEE- C57.32
13	UPS, SMPS and Other Power supply units	IEC- 62040 IEC- 61558
14	Cyber Security	IEC-62243

C.3 Scope of work for STATCOM

The scope of work with regard to the works associated with the STATCOM shall comprise ± 300 MVAR Modular Multi-level Voltage Source Converter (MMC-VSC) based STATCOM along with 2x125 MVAR MSC (Mechanically Switched Capacitors) and 1x125 MVAR MSR (Mechanically Switched Reactors).

STATCOM can either be Single/ multiple units. The minimum size of a unit allowed is 150 – 200 MVar. TSP shall ensure that there are no coordination issues between multiple STATCOM branches of STATCOM station. Further complete Dynamic range for STATCOM may also be installed based on appropriate studies instead of combination of VSC with MSC/MSR technology. Minimum MV bus voltage is to be decided by OEMs.

The TSP shall be responsible for the complete installation of STATCOM station along with the substation works as specified in the complete scope of work.

The TSP shall also perform the system studies (steady state and dynamic) according to the requirement mentioned and documentation of the same shall be preserved by TSP and to be submitted to CEA/CTU/GRID-INDIA, as per their request.

Central Transmission Utility of India Limited

119

Bikaner A Power Transmission Limited

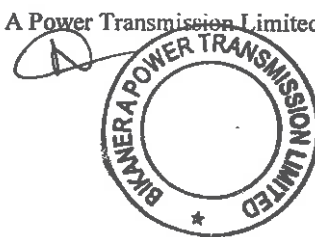
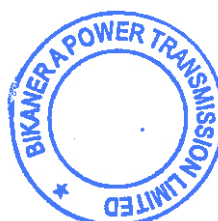
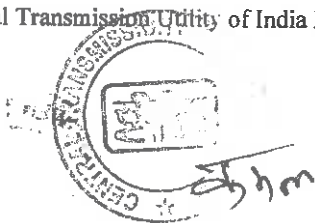

184

TSP shall carry out a detailed study on prevailing system conditions before interconnection of the STATCOM to assess the performance of the STATCOM. Parameters tuning to avoid any adverse impact on the grid with integration of the STATCOM shall also be identified and implemented at this stage. TSP shall carry out tuning of Power Oscillation damping (POD) along with an interaction study with nearby HVDC/FACTS controllers. In line with previously executed projects in India, the tuned network file with 'no initial conditions suspects' and a converged file shall be provided by CTU to TSP. These files shall be made available within 60 days from award of the contract.

TSP shall ensure interconnection study at the time of commissioning and shall also be responsible for tuning the POD during the license period as per relevant standards (e.g. IEEE 1052).

The switchgear for connection of STATCOM units, MSCs and MSRs provided on the secondary side of the coupling transformer shall be of standard voltage rating as per relevant IEC. The switchgear, structure, control, protection and substation automation on the 400 kV side shall be as per applicable Technical Specification of the substation equipment.

Generally, the purpose of STATCOM is to improve system stability, provide damping, and smooth out the step voltage change associated with MSCs, MSRs and external compensating equipment (i.e. any existing capacitor and reactor banks) switching and provide steady state VARs as needed to support the 400 kV bus voltage.

In order to get optimum control of MVAR, the control of MSCs and MSRs, as well as reactor banks connected on the 400 kV HV side, may be integrated along with STATCOM control to provide steady state 400 kV bus voltage control in a smooth manner. MSRs and MSCs are to be switched to relieve the STATCOM from high level operation, reduce its continuous losses and maximize its dynamic control potential. There should be a provision for the independent operation of MSC/MSR after delinking it with STATCOM controls when STATCOM is out of service due to any reason. Switching of MSC/MSR shall be based on value of external bus voltage.

The operating functions of the STATCOM Station shall include:

- Steady state voltage control of 400 kV bus,
- Balance steady state voltage at 400 kV bus,
- Dynamic over-voltage control,
- Transient and Dynamic stability control
- Damping of Power Oscillations

It is assumed that the arresters will limit any transient and switching surge over voltages and may also, by design, limit dynamic over voltages.

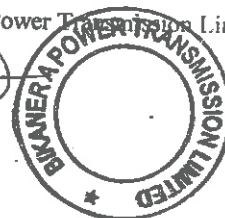
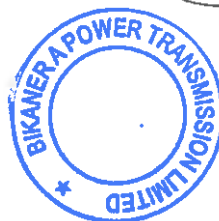
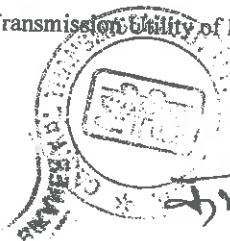

The requirement of reactive power compensation (as defined above) guaranteed by the TSP shall not be less than the levels specified considering following.

- The total cumulative Capacitive (+) and Inductive (-) MVAR rated Capacity of STATCOM Station as defined above comprising of STATCOM, MSCs (as applicable), MSRs (as applicable) coupling transformer, coupling reactor or any filter (if applicable) shall be rated at 1 p.u. voltage, 1 p.u. frequency and 50 °C (Celsius) ambient temperature at 400 kV Bus (Referred to as "Point of Common Coupling" or PCC).
- Capacity of one or more branches of MSC, MSR in STATCOM Station can be included in the STATCOM with equivalent capacity. Accordingly, ratings of STATCOM Unit/Branch equipment may be designed.

Example of equivalent acceptable solutions for each STATCOM Station is given below:

For ±300 MVAR STATCOM:

Option 1: ±300 MVAR STATCOM, 2x125 MVAR Mechanically switched Shunt Capacitor (MSC), 1x125 MVAR Mechanically switched Shunt Reactor (MSR).

Option 2: +425/-300 MVAR STATCOM, 1x125 MVAR Mechanically switched Shunt Capacitor (MSC), 1x125 MVAR Mechanically switched Shunt Reactor (MSR).

Option 3: +300/-425 MVAR STATCOM, 2x125 MVAR Mechanically switched Shunt Capacitor (MSC).

Option 4: ±425 MVAR STATCOM, 1x125 MVAR Mechanically switched Shunt Capacitor (MSC)

Option 5: +550/-425 MVAR STATCOM

- The rated capability of STATCOM, MSC (as applicable) and MSR (as applicable) shall be at 400 kV (Referred to as "Point of Common Coupling" or PCC) and in the steady state frequency range of 48.5 Hz-50.5 Hz.

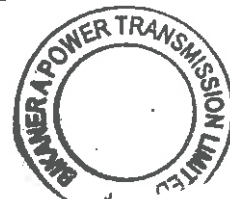
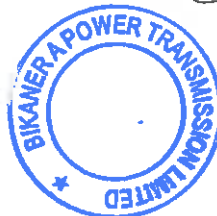

- The STATCOM Station including STATCOM Units, MSCs and MSRs shall be designed to operate continuously under the worst possible combination of steady state voltage range of 360-440 kV and frequency range of 47.5 Hz – 52.5 Hz respectively and transient and temporary over voltages defined in Clause C.6.1-f).
- The AC voltage unbalance at fundamental frequency shall be assumed equivalent to a negative phase sequence component of 1.5% for equipment rating purposes.
- The reactive power compensation levels shall be determined by manufacturing tolerances of the components and measurements carried out using metering accuracy instrumentation at the 400 kV feed points to the STATCOM Station.
- The reactive power capability shall also be determined by calculations based on test values of appropriate quantities at the discretion of the owner.
- In calculations of capability and availability, the owner shall assume the most unfavourable combinations of control, manufacturing and measurement tolerances.
- In case more than one STATCOM Station are installed in a particular substation, each STATCOM Station shall be connected to 400 kV bus individually with complete separate downstream system. Each individual STATCOM station shall have complete independent yet coordinated control system to avoid simultaneous tripping of both STATCOM Stations. The system shall be design in such a way that single common contingency (other than loss of 400 kV voltage, abnormal system events) will not cause tripping of both STATCOM Stations.
- Operation of STATCOM Station shall not excite any resonance condition in connected Power System.
- Control of STATCOM Station shall be designed to prevent hunting between MSRs, MSCs and STATCOM.

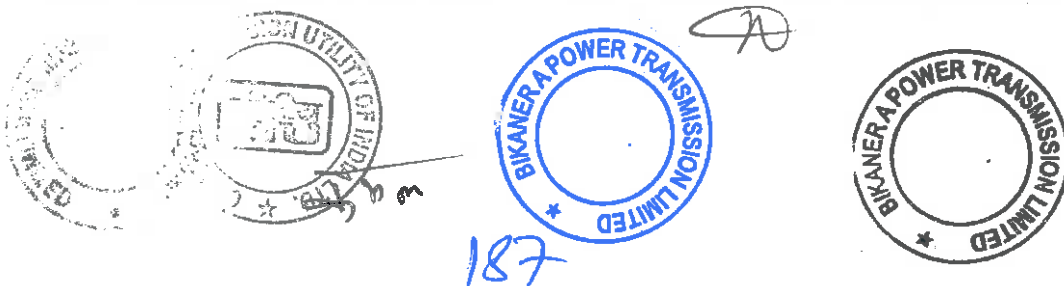

C.3.1 STATCOM building

The STATCOM station shall have an independent building including a separate control room different from the main control room building of the 765/400 kV Substation.

The STATCOM Building shall comprise of following facilities:

1. Control and Relay Panel room
2. ACDB and DCDB room
3. Battery room
4. Service Room cum workshop
5. Conference room
6. Valve hall
7. Cooling system room
8. Lobby
9. Corridor with minimum width of 1600 mm
10. Portico
11. Common Toilet
12. Provision of shaft for electrical, sanitary, water supply facilities
13. Other facilities as per functional requirement of building
14. AHU Room

C.4 Ambient Condition

STATCOM Station should be designed to perform at 50 °C ambient temperature.

C.5 Power System Characteristic

The following AC power system characteristics apply at the point of connection i.e. point of common coupling in this case (PCC). STATCOM station operation is required within the parameter value and duration given in following table:

S. No	Power System Characteristic	Value	unit
1.	Nominal ac system voltage, line-to-line	400	kV
2.	Maximum continuous ac system voltage, line-to-line	420	kV

Central Transmission Utility of India Limited

123

Bikaner A Power Transmission Limited

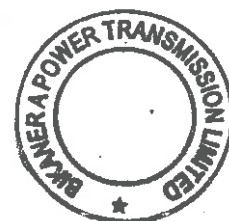
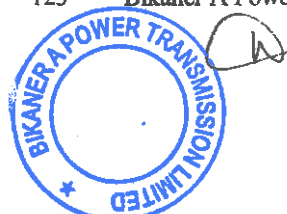
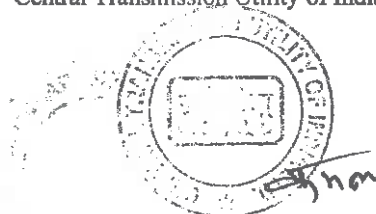

S. No	Power System Characteristic	Value	unit
3.	Minimum continuous ac system voltage, line-to-line	380	kV
4.	Maximum short-term ac system voltage, line-to-line	448	kV
5.	Maximum duration of item 4	10	s
6	Continuous negative-sequence voltage component (used for performance calculation)	1	%
7	Continuous negative-sequence voltage component (used for rating calculation)	1.5	%
8.	Continuous zero-sequence voltage component	1	%
9.	Nominal ac system frequency	50	Hz
10.	Maximum continuous ac system frequency (for rated output)	50.5	Hz
11.	Minimum continuous ac system frequency (for rated output)	48.5	Hz
12.	Maximum short-term ac system frequency	52.5	Hz
13.	Minimum short-term ac system frequency	47.5	Hz
14.	Basic Insulation Level (BIL)	1550	kV peak
15.	Switching impulse level (SIL)	1050	kV peak
16.	Power Frequency Withstand voltage	630	kV
17.	Maximum three-phase fault current a) for performance requirements	a)	kA

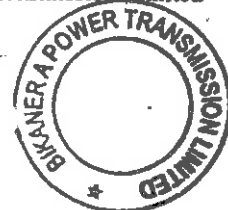
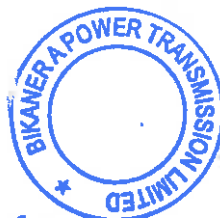
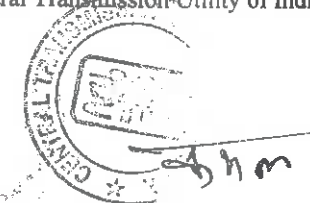

S. No.	Power System Characteristic	Value	unit
	b) for rating of STATCOM X/R (Positive/Negative Seq)* X/R (Zero Seq)* Clearing time - normal Clearing time - backup	b) _____ _____ _____ _____	kA for 1s s s
18.	Maximum three-phase fault current	_____	kA
19.	Minimum three-phase fault current # -for performance requirements -for safe operation	_____ _____ _____	kA kA
20.	Maximum single-phase fault current	_____	kA
21.	Minimum single-phase fault current#	_____	kA
22.	Harmonic impedance sectors for each harmonic number up to the 49 th harmonic or system impedance data as R-X values with frequency steps not larger than 1 Hz (for performance and/or STATCOM system component rating)	Chapter 7.3 of CIGRE Publication 139	
23.	Background harmonic voltage (or current) spectrum (for STATCOM	5th Harmonic 1.5% 7th Harmonic 1.0%	

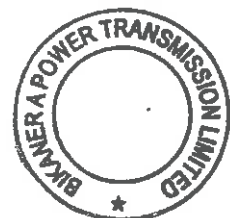
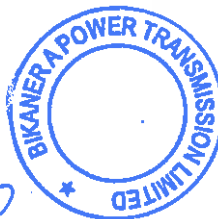
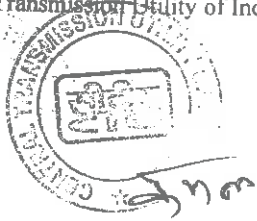

190

S. No	Power System Characteristic	Value	unit
	components rating) (Distortion up to 15th Harmonic	Other Harmonics 0.5%	(each)
24.	Power System Phase Rotation	CCW	

Note: Parameter Values for S.No. 19 to 23 shall be provided at later stage along with

Network file (PSS/E)

For STATCOMs near RE complex:

The STATCOMs shall remain connected to the grid and shall be able to operate at rated reactive power capability when voltage at the interconnection point, on any single phase or all three phases dips up to the level depicted by the thick lines in the following curve (for specified time) and up to atleast 0.3 pu in case of 2 phases:

V_T : Actual Voltage; V_n : Nominal Voltage

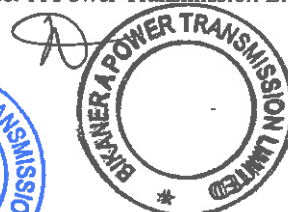
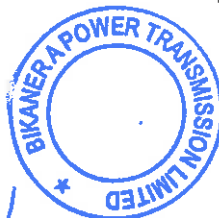
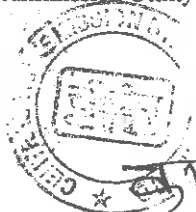
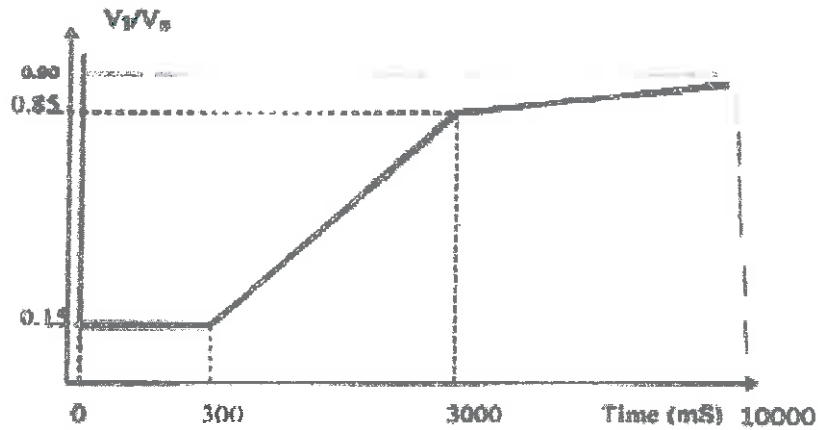

C.6 STATCOM Station Characteristics

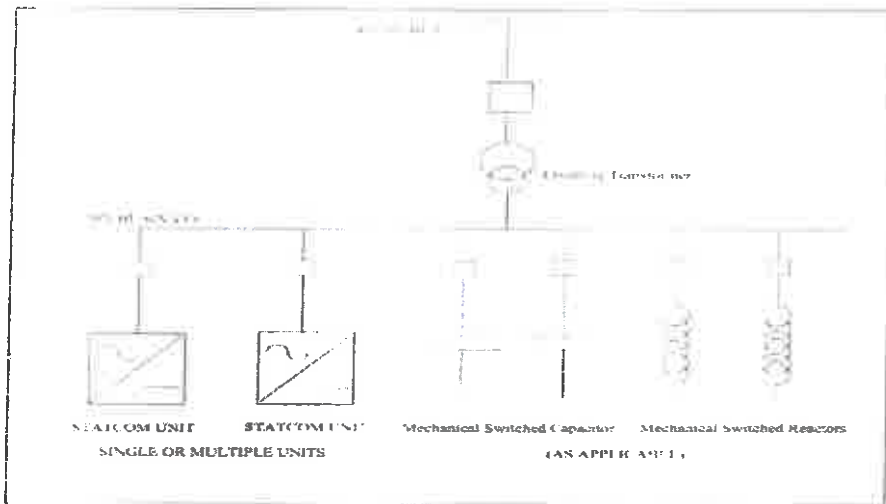
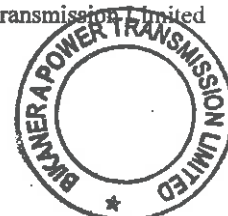
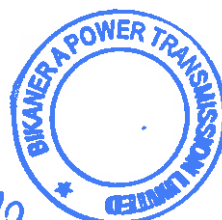

Figure-1: Conceptual Indicative Schematic diagram of STATCOM Station



192



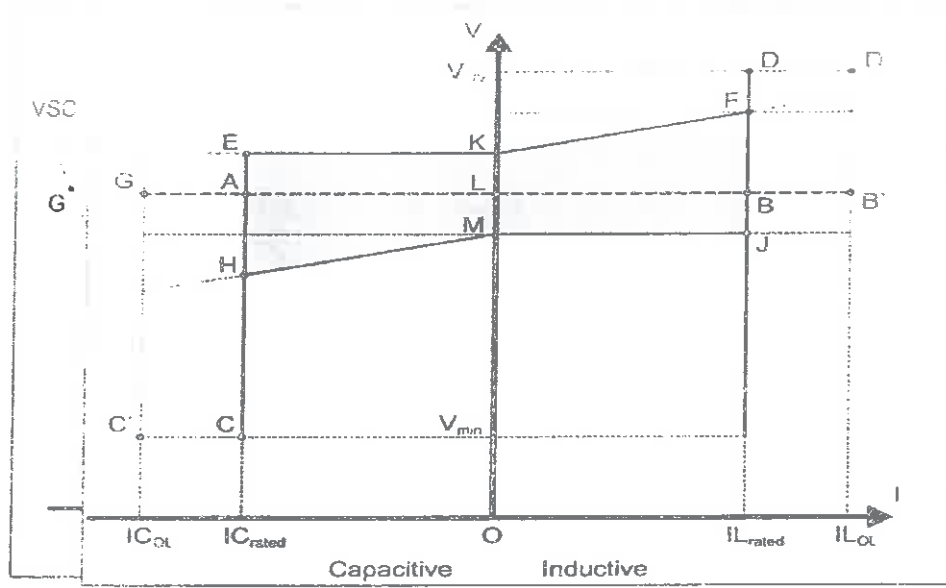

Figure-2: VI Curve of the VSC Portion

Central Transmission Utility of India Limited

128

Bikaner A Power Transmission Limited

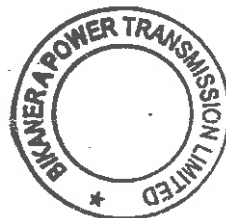
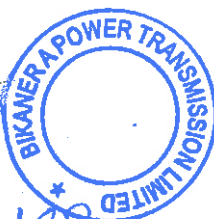
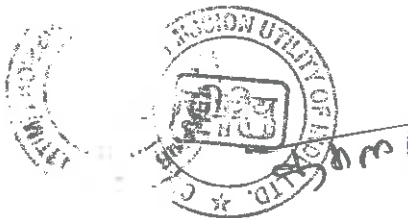

Figure-3: VI Curve of the STATCOM Station

C.6.1 STATCOM Station Ratings

The output of a STATCOM Station shall be adjusted continuously over the range illustrated in Figure-3.

The following items define the ratings of the STATCOM station equipment.

- The STATCOM Station should regulate the 400 kV bus voltage to a reference voltage of 400 kV (1.0 per unit, Point L Figure-3), continuously adjustable between 0.95 per unit and 1.05 per unit.
- The nominal capacitive and inductive reactive power output of the STATCOM should be as defined in the scope, at 1.0 pu ac bus voltage and nominal system frequency f , and 50°C ambient temperature (Point A and point B of figure-2).
- The slope of the STATCOM Station characteristic should be adjustable in steps of not greater than 0.5% between 1% and 8%, on a basis of cumulative MVA capacity of STATCOM Station (A+B in Figure-3).
- The STATCOM Stations near RE Complex shall continue to inject reactive power during temporary under voltage down to 60 kV (0.15 pu) for the duration 0.3 sec (Point C) and STATCOM behavior for voltages above 0.15 pu shall be as specified under section C.5 above; the STATCOM system may be tripped (or blocked) if the under voltage persists for time beyond limits specified under section C.5 above.

The STATCOM Stations (other than RE Complex) shall continue to inject reactive power during temporary under voltage down to 120 kV (0.3 pu) (Point-C) for the duration 5 sec; the STATCOM system may be tripped (or blocked) if the under voltage persists for time beyond limits specified under section C.5 above.

- The STATCOM shall continue to absorb reactive power during HVRT Conditions in a controlled manner as per the following.

Nominal Voltage (pu)	Minimum time for remaining connected to the Grid
$V > 1.50$	Instantaneous trip
$1.50 \geq V > 1.30$	100 milli seconds
$1.30 \geq V > 1.10$	10 seconds

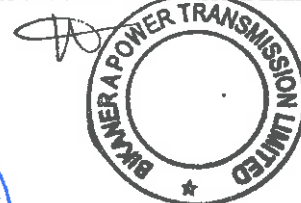
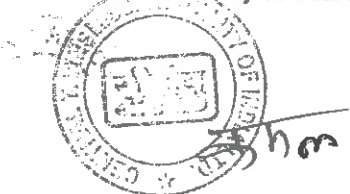

19/4

$V \leq 1.10$

Continuous

STATCOM Station may be tripped if the respective temporary over voltages as mentioned above persists for more than its respective mentioned duration.

- f) The STATCOM Station should be capable of repeating temporary operation as defined in any one of item (d) and (e) as above for at least 3 charging cycles in 60 mins.
- g) The coupling transformer and all bus equipment, such as filter branches (if applicable), MSC and MSR branches etc. and the MV Bus should be rated to withstand the specified continuous and short-term operation, and to withstand or be protected against voltage and current stresses that exceed these conditions.
- h) All equipment in the STATCOM Station should be capable of sustaining, without damage, any fault limited by the maximum design short circuit level of the system and the Coupling transformer impedance.
- i) The TSP shall assume the negative sequence voltage of 1% at rated short circuit level and provide control to reduce this unbalance.
- j) The injected harmonic current distortion by STATCOM Station under the full operating range measured at 400 kV Bus (PCC) in accordance with IEEE- 2800 standard.
- k) The STATCOM controls should be designed to correct negative sequence voltage during steady state operation.
- l) The switching module design should include an appropriate allowance for stray capacitance and component tolerances.
- m) The STATCOM should be designed to prevent, or alternatively to withstand, false firing events, i.e., the firing of any valve at an incorrect time in the cycle or when not ordered.

C.6.2 Control Objectives

The control system shall control the STATCOM, MSCs, MSRs required under this specification, as well as all bus reactors on the 400 kV HV bus of the substation.

Operation logic for the breakers, disconnectors and earth-switches in the STATCOM Station shall also be incorporated in the control system. The control shall be programmable and shall have sufficient scope and flexibility (software programming margin of at least 20%) to permit re-programming according to future changes/addition in the power system. The operator interface must be integrated in a latest version of Windows environment.

C.6.2.1 STATCOM Station Functions and Applications

C.6.2.1.1 Voltage Control mode (Automatic and Manual)

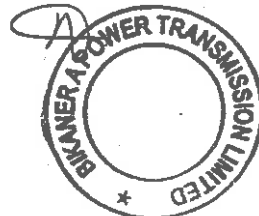
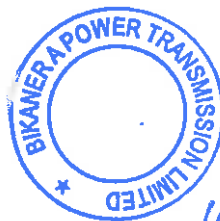

The Control of the positive sequence component of the fundamental frequency voltage in steady state at POI, with slope in the range as specified at clause 6.1 c) above.

There shall be following provisions in STATCOM System to operate in Voltage Control Mode:

- a) To adjust the reference voltage for changes by Grid operator.
- b) To adjust the value of reactive power droop in p.u. to provide a stable, coordinated and dynamic response.
- c) To adjust the voltage dead band with a minimum magnitude of ± 0.05 pu

C.6.2.1.2 Fixed Reactive Power Mode

In this mode, the STATCOM system shall maintain a specified constant reactive power output at the POI under continuous / steady state operating region. The target reactive power level and mode (injection or absorption) shall be specified by the Grid operator. There shall be a provision to adjust the reactive power set point. The dynamic response of the STATCOM system to any changes in reactive power shall be positively damped with a damping ratio of 0.3 or better.

C.6.2.1.3 Steady State Condition

The STATCOM Station (STATCOM along with MSCs and MSRs) shall provide necessary reactive power support to the 400 kV bus (PCC) to compensate for voltage variation under steady state.

C.6.2.1.4 Dynamic Over-voltage Control Performance

The STATCOM shall be required to provide necessary reactive power support with fast and smooth variation so that over-voltages under dynamic conditions are controlled. STATCOM shall smooth out the step caused by the switching of MSCs and MSRs.

The operation of each STATCOM over its range of MVAR from full capacitive to full Inductive capacity and vice-versa shall be on the basis of smooth variation.

C.6.2.1.5 Transient and Dynamic Stability Performances

The STATCOM Station shall provide necessary reactive power so that the transient and dynamic stability of the Owner's system is enhanced.

C.6.2.1.6 Damping of Power Oscillations

The STATCOM shall provide necessary damping to power oscillations by modulating its output in its entire range based on the measured rate of change of power/frequency at the 400 kV bus. The damping controller would track local area oscillations as well

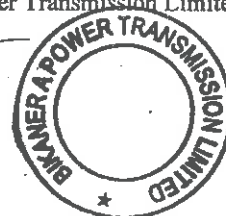
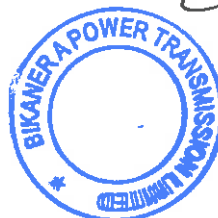
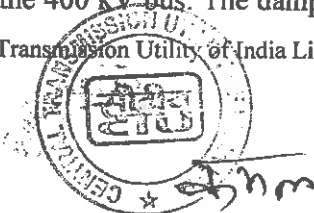

as wide area oscillations and control would include several loops each focused on different frequencies.

TSP shall ensure the damping of oscillation during the entire license period including the pre-commissioning period as per relevant standards. (e.g. IEEE 1052).

C.6.2.1.7 Facility for compensation of phase imbalance

Provide negative phase sequence voltage control to minimize the presence of negative sequence content of the 400 kV bus voltage.

C.6.2.1.8 Start up and Initial Switching

The operation of STATCOM Station during start-up/initial switching on should not create significant energizing transients causing voltage drop, voltage distortion and swinging of transmission voltage angle at the PCC bus by more than +/-5%. TSP shall have to ensure this analytically during the design phase and also in the field after the commissioning of the facility. TSP shall prepare the design documentation and the same shall be preserved by TSP and to be submitted to CEA/CTU/GRID-INDIA, as per their requirement.

C.6.2.1.9 Gain Supervision and Control

To control the regulator gain in order to prevent oscillations and excessive overshoot in the STATCOM response, a gain supervision function shall be implemented. This shall be an essential function for the supervision of stability of closed-loop voltage control. The function of this controller is that when the supervision of the gain in the voltage regulator detects oscillations in the voltage controller output, the gain shall gradually be reduced until stability is reached. Normally it is a changed condition in the transmission system contribution to the closed loop gain that results in instability. The reduction in the voltage regulator gain shall only balance the external change. The control should be adaptive in order to maximize its effectiveness. Gain reductions should be indicated and the reduction of the gain shall be able to be reset to nominal value by means of commands from the operator interface or automatically. A relative gain factor shall also be able to be changed from a gain optimizer.

C.6.2.1.10 Coordinated reactive power control of external devices

To optimize the use of dynamic VARs versus steady state VARs, control of externally connected shunt capacitor or reactor banks shall be implemented. Such banks will be connected locally to a HV bus or/and at MV bus. For simultaneous control with the supplementary VSC current controller, coordination for the two functions shall be provided. External devices like mechanically switched capacitors (MSC)/mechanically switched reactors (MSR) can be switched ON or OFF to position the steady state operating point of the VSC so as to extend its dynamic range. There should be a provision for independent operation of MSC/MSR after delinking it with STATCOM

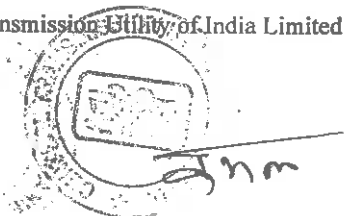

197



Handwritten signature

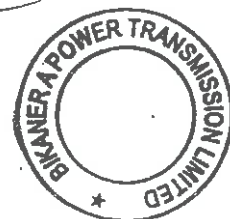

controls when STATCOM is out of service due to any reason. The threshold values for switching the MSC/MSR on/off shall be configurable in all modes of operation.

C.6.2.1.11 Supplementary VSC current controller

To optimize the use of dynamic VARs versus steady state VARs, a control function that slowly reduces or offsets the STATCOM point of operation shall be implemented. By deliberately adjusting the voltage reference setting within a narrow window the STATCOM system output is pushed towards either a specific point or towards a window to preserve dynamic range. This slow operating function is meant to provide for slower controllers, such as externally connected shunt banks to operate and meet the slower long term voltage variations caused by daily or weekly load variations. Rapid changes in the system voltage that call for dynamic compensation will have priority over this type of controller.

C.6.2.1.12 Gain optimization

To provide operation at optimal regulator gain, a fully automatic optimizing function shall be implemented. This function operates by inducing a small change in the STATCOM output. The gain is adjusted based on the network response signal.

C.6.2.1.13 Control of Direct Current

During STATCOM operations, any flow of direct current to the transformer's MV side must be less than 25% of the transformer magnetizing current. DC current flow in the transformer should be minimized by an independent control function that minimizes DC current. For presence of up to 0.2% second harmonic in 400 kV system, the STATCOM control should minimize DC current flow in the transformer.

C.6.2.2 Under Voltage Strategy

It is essential that the STATCOM Station operates in a robust manner when transmission system under voltages appears. For transmission system voltages down to 0.15 p.u. for single phase or three phase fault and 0.3 p.u. for two phase faults, the STATCOM units must operate unrestricted, producing its rated capacitive current. The STATCOM must be designed to operate at transmission system under voltage, even considering that severe voltage unbalances can appear. The STATCOM must not be restricted by short term negative sequence voltages up to 1.5%, appearing in conjunction with under voltages.

Transmission system under voltages below 0.15 p.u. will appear in conjunction with transmission system faults. The STATCOM must ride through during faults and post fault under voltages. The minimum trip delay for the STATCOM Station, upon complete loss of the transmission system voltage shall not be less than 5 seconds. If station AC auxiliary power distribution is affected, critical loads must be fed from DC

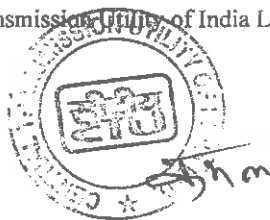

198

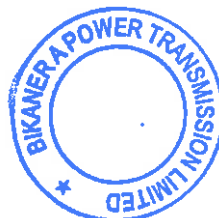
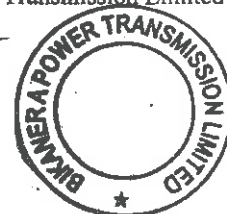
station batteries, uninterrupted power supply (UPS) without tripping the STATCOM Station. Adequate capacity must be kept in DC station batteries, UPS to feed critical loads for the smooth operation of the STATCOM Station facility. There must be redundant station battery system with each station battery system capable of delivering 100% load.

At under voltage conditions for the transmission system voltage, special control strategies are activated which override the normal control modes presented above. Normally if the voltage is low, the output from the STATCOM will be capacitive. If the voltage in all three phases goes below a level, but not greater than 0.15 p.u., a special under voltage strategy may be activated that controls the STATCOM output to 0 MVAR. As soon as the voltage goes higher than 0.15 pu, the under voltage strategy is deactivated and the normal control will be in operation (for the specified duration).

The STATCOM Station must not be tripped or shut down automatically due to under voltages appearing for specified duration as specified under section C.5 above. STATCOM Station must continue to operate when AC system Voltage on any or all phases dips down to 0.15 p.u. voltage as per the characteristic given at section C.5.

C.6.2.3 Over Voltage Strategy

- C.6.2.3.1** The TSP shall carry out dynamic stability study upfront in order to assess the dynamic overvoltage requirements. These studies shall include conditions with maximum and minimum short circuit system MVA conditions, single phase and three phase faults as well as stuck breaker, outage of the nearby generator and also with the outage of parts of the STATCOM Station. It is important that the STATCOM Station rides through temporary over voltages and not trip when it is needed the most.
- C.6.2.3.2** The system should be able to withstand any 3 phase, 5 cycle (100 ms) and single phase 10 cycles (200 ms) fault with consequent loss of a 400 kV double circuit line and loss of a 500 MW generator. The fault duration mentioned above corresponds to time assumed for the persistence of fault. For other system parameters refer clause 5 above (Power System Characteristics). In addition to above requirement, system contingency cases as provided in Annexure-I need to be considered and satisfied.
- C.6.2.3.3** The 400 kV system and equipment to which the STATCOM Station is connected is designed to withstand switching surge overvoltage up to 2.5 p.u. and power frequency over voltages up to 1.5 p.u. with initial value of the temporary overvoltage up to 2.0 p.u. for 1-2 cycles. Based on arrester coordination and under the worst case scenario the 400 kV system phase to ground peak over voltages may be expected as follows
- i) 650 kVp for 03 peaks

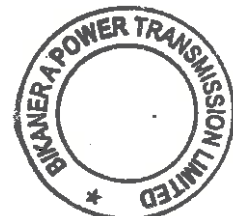
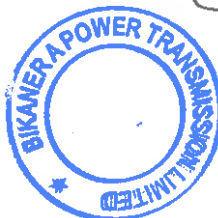
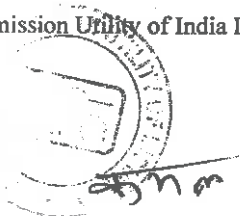

- ii) 575 kVp up to 5 cycles
 - iii) 530 kVp up to 1 second
 - iv) 475 kVp up to 10 seconds
- a) The STATCOM Station shall be designed to withstand these sequential over voltages.
 - b) If the over voltages greater than 1.1 pu are exceeded in magnitude and duration due to any system contingencies, suitable control action shall be taken by STATCOM Station to bear this kind of contingency.
 - c) The TSP shall evolve the insulation co-ordination of the components of the STATCOM Station after studies have been conducted to determine the over- voltage profile with the STATCOM connected to the system.
 - d) The TSP shall ensure that STATCOM Station will not excite ferro-resonance and sub-synchronous oscillation in the AC system. The study report in this regard shall be preserved and to be submitted to CEA/CTU/GRID-INDIA, if required.
 - e) It may also be noted that the tripping action for 400 kV lines is initiated if the overvoltage exceeds 1.1 p.u. for 10 seconds. The tripping of 400 kV lines is initiated if 1.3 p.u. voltage persists for more than 100 milli seconds. The over voltage strategy shall be coordinated with these settings such that the STATCOM Station rides through up to these levels.

C.6.2.4 STATCOM Station Over load / Over Current

The overvoltage cycles mentioned in clause 6.2.3.3 above create a corresponding current overload in the STATCOM Station components; the STATCOM Station and its components shall be designed to withstand these.

In addition to the above the STATCOM Station and its components shall be designed to withstand overloading caused due to the following eventualities.

- i) Short circuits and ground faults in the 400 kV system especially those occurring near the STATCOM Station and medium voltage bus of the STATCOM Station.
- ii) Transient overvoltage due to switching operations and atmospheric effects.
- iii) Temporary over voltages.
- iv) Short circuits in the transformer secondary circuit such as:
 - Bushing terminal fault
 - Flashover across a reactor, Bus Bar and other connected components/switchgear etc.
- v) Protection system faults.

If the rated overvoltage is exceeded as a result of prolonged stressing or for other reasons, the protection specified elsewhere in the specification shall come into effect to prevent damage.

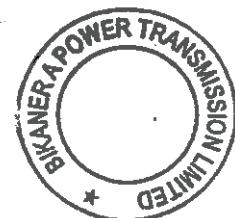
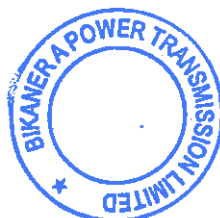

C.6.2.5 Dynamic Performance Controls of STATCOM Station

The TSP must describe in detail, the dynamic reactive power controls for enhancing stability margin and also damp oscillations of any critical frequencies. The dead band for continuous damping control must be very small so that there are no discernible sustained oscillations.

C.6.2.6 Protective Control Functions

TSP shall provide all necessary protections including Main and Back-up protections for all protective zones and equipment like transformers, STATCOM Units, MSCs (if applicable), MSRs (if applicable), MV Bus Bar etc. TSP shall provide any protective control functions to meet the performance requirement of STATCOM under the scope of the TSP.

a) Overvoltage Protection

TSP shall provide adequate overvoltage protection as a result of any normal operation, mal-operation or system event.

b) Over current Protection

TSP shall provide adequate over-current protection for the STATCOM Station as a result of any abnormal operation, mal-operation or system event.

c) Gate level control Supervision

TSP shall provide adequate Sub module Gate level control supervision.

C.6.2.7 STATCOM Station Response

STATCOM station response shall be such that the change in measured system voltage to small disturbance should reach 90% of the desired total change within 30 ms of initiating a 5% step change of voltage reference. The maximum overshoot should not exceed 120% of the total change and the settling time should not exceed 100 ms, after which the voltage should be within $\pm 5\%$ of the final value. This response characteristic within these limits must be respected when the system's three-phase fault MVA is between the minimum and maximum value defined in clause-5. The response of the system voltage using the actual controller should be validated on a real time simulator during the factory acceptance test (FAT) at the manufacturer's premises. For the purpose of STATCOM Station, response time measurement and signal conversion of the voltage, the error should not exceed 0.3%. The voltage response acquisition circuit should have a response time of no longer than 10 ms. However, time longer than 10 ms can be allowed provided the requirement of STATCOM response time is met.

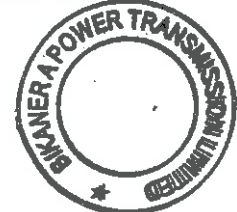
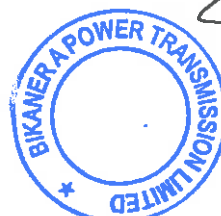

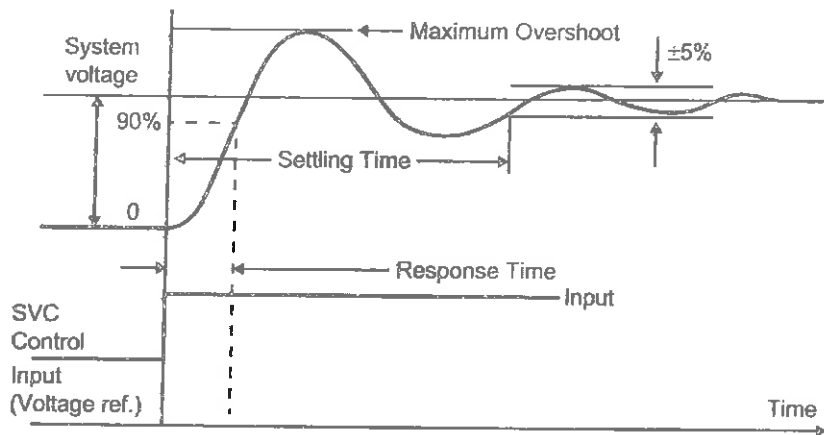

Figure-4 Response and Settling time

C.6.3 Harmonic performance and AC harmonic filter design

It is likely that with multi-level VSC based technology, no filters or only a small high-pass filter will be needed. The STATCOM shall be operable without AC filters. The STATCOM Station should be designed to eliminate the effects of any harmonic resonance between its MSRs, MSCs banks, filter branches, and the AC system. To limit the harmonic distortion imposed on the 400 kV transmission system, the additional contribution of harmonic distortion from the STATCOM Station to 400 kV system (PCC) should not exceed 1% for the total and 0.5% for any specific harmonic.

C.6.3.1 Filter performance

The distortion levels as specified should be met for the following:

- The continuous range of all system and environmental conditions.
- Variation in total filter capacitance due to manufacturing tolerance, ambient temperature, aging, and changes in capacitance up to alarm level.
- Variation in tolerance for STATCOM parameters, such as transformer winding unbalances, valve firing variations MSC and MSR unequal reactor and capacitor reactance between phases.
- System frequency in the range of 48.5 Hz to 50.5 Hz. Calculation should take into account all possible combinations of STATCOMs, MSCs and MSRs.

C.6.3.2 Filter component rating

The harmonic filter components (and other STATCOM components) should be rated to carry continuously the harmonic currents caused by the background harmonic

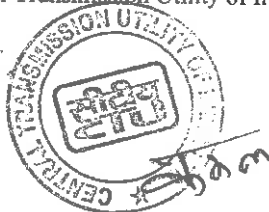

distortion of the system and the harmonic currents produced by the STATCOM itself. Unless otherwise specified, harmonic currents from the system and the STATCOM of the same order should be added arithmetically. All filter harmonic currents of different order should be added quadratically (root sum of squares).

The rated voltage of capacitors should be derived from the largest arithmetic sum of the power-frequency and individual harmonic voltages obtained from stress calculations in continuous operating conditions (Note: Maximum fundamental voltage and maximum harmonic contributions may not exist at the same time for STATCOM configurations including MSRs or MSCs).

For filter capacitor voltage rating, the loss of capacitor unit or elements should be considered up to the trip level.

The rated voltage of so-called "low voltage" capacitors (e.g. in double or triple tuned filters) should be chosen such as to also withstand imposed transient stresses from faults, energization, or other switching events.

C.6.3.3 Harmonics at PCC

The STATCOM Station's contribution to the harmonic distortion levels at the STATCOM Station connection point (PCC) to the transmission system shall not exceed the limits defined in IEEE-2800 standard.

C.6.3.4 Harmonic calculation:

Chapter 7.3 of CIGRE Publication 139 together with information in PSSE network files given shall be used for the Network harmonic impedance.

C.6.4 MV Switchyard

- Medium Voltage (MV) delta bus shall be grounded through a Grounding Transformer (i.e. zig-zag winding Transformer) along with a suitable resistor in the neutral.
- MV Switchyard of different STATCOM Station branches shall be fenced with a fence height of 3 meter. To minimize the probability of electrical fault suitable arrangement i.e. electrified fence shall be done to prevent the encroachment of unwanted animals or other to minimize the probability of electrical faults (Ph-E, Ph-Ph). Further bus bar arrangements shall be made in a way to minimize the probability of electrical faults.
- Secondary side of the Coupling Transformer shall be provided with suitable surge capacitors to mitigate transfer surges.

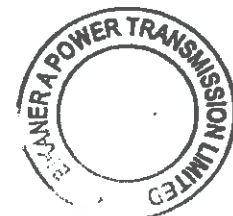
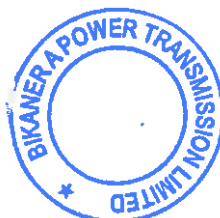

- For MV bus bar, an Aluminum conductor (Tube, Rectangular Hollow Section or C Section) may be used, however, a suitable bus bar end cover/cap shall be provided to avoid any animal/bird entering the hollow space.

C.6.5 Broadband Interference

C.6.5.1 Radio Interference

The TSP shall take necessary precautions in the form of shielding of valve hall and building or Containers to meet its own requirement together with any requirements that may be specified in Section-Project. Further, the following requirements shall also be met:

- With the STATCOM Station operating at any load upto rated value and within the design range of firing angle, the radio interference level from electromagnetic or electrostatic inductions generated by the STATCOM station shall not exceed 100 micro-volts/m, under fair weather conditions, at 500 m away from STATCOM fence or boundary of the substation whichever is higher.. The Radio Interference Level (RIL) criteria shall be achieved at all frequencies within the range of 150 kHz to 300 MHz and with the STATCOM operation at any level up to and including rated value, the design shall provide correcting measures in case the specified design not being realized in the final installation. In case of any third-party complaints about the radio interference, suitable measures shall be implemented by TSP..
- Measurements of actual RI at STATCOM Station shall be made by the TSP, at points along the above defined contour and at other critical points.
- RIV (Radio Interference voltage) measured at a phase to ground voltage (266 kV rms) in accordance to NEMA-107 shall not be more than 500 micro-volts for 400 kV system. For other system voltages, IEC/NEMA in the order of preference shall be applicable.

C.6.5.2 Interference with Power Line carrier and open wire carrier system

The TSP shall take the necessary precautions in the form of noise suppression techniques and filtering devices to prevent harmful interferences from STATCOM Station to the power line carrier communication (PLCC) system operating on connected AC transmission network.

The frequency spectra to be protected are:

System	Frequency spectrum
Power Line carrier	30 kHz to 500 kHz
Open wire carrier	5 kHz to 30 kHz

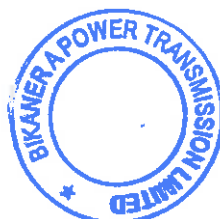
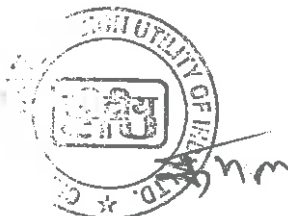

204

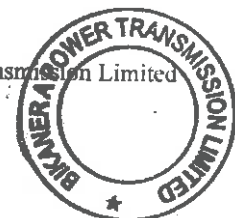

C.6.6 Audible Noise

The TSP shall limit the audible noise in various areas of the STATCOM Station buildings and containers to the following values.

Valve hall (Inside)	90 dBA
Mechanical equipment areas indoor (measured at 2 meter distance)	75 dBA
Mechanical equipment outdoor (Measured at 15 m distance)	75 dBA
Control Room Building*	60 dBA
At the limits of the STATCOM STATION perimeter fence	80 dBA

**This is the background noise from the ventilation system in adjacent rooms, control cubicles etc. Printers, recorders may be switched off during the measurement.*

C.6.7 Loss Requirements

C.6.7.1 The TSP must guarantee the total losses of STATCOM Station, be less than 1% of the reactive power output individually at its inductive limit (STATCOM+MSRs) and capacitive limit (STATCOM+MSCs) for the cumulative highest reactive power output of STATCOM Station at PCC with the worse combination of manufacturing tolerances for the Option-1 to 4 as provided in clause C.3. In case of Option 5 as provided in clause C.3 i.e. +550/-425 MVar STATCOM without MSC and MSR, the TSP must guarantee the total losses of STATCOM Station will be less than 1.5% of the reactive power output individually at its inductive limit and capacitive limit for the cumulative highest reactive power output of STATCOM Station at PCC with the worse combination of manufacturing tolerances. For the purpose of total loss measurements, it should be assumed that the ambient temperature is 20 °C, the PCC voltage is 1 per unit, and the slope setting is 1%. The STATCOM system may not operate under these conditions, but they provide a common base.

C.6.7.2 The total losses shall include all components, as well as different parts or subsystems of the complete STATCOM Station such as coupling transformer, All VSC systems and components, MSC and MSR, Control and protection systems, including ancillary devices such as HMI, fault recorders, and SCADA, Auxiliary Power supply systems, cooling systems, Building ancillary services such as lighting, air conditioning, heating, and ventilation. It may be noted that for the redundant VSC valve levels and dual/redundant control and protection systems, the losses of redundant VSC valve

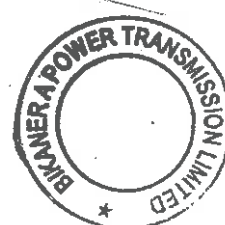
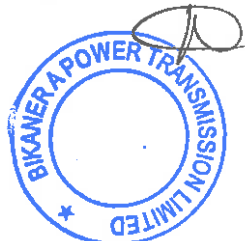
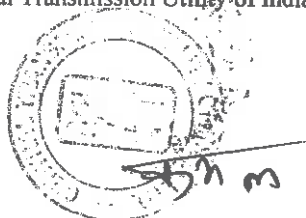

levels and dual control and protection systems shall be considered during loss measurement.

C.6.7.3 For the dual or redundant systems design of STATCOM Station, such as dual pumps or redundant fans, dual systems losses are to be excluded, if the dual system is not in service during the normal operation of the STATCOM Station. However, dual systems should be included if they are required to be in service under the defined operating conditions. The same methodology shall be applied for HVAC (heating ventilation and air conditioning systems).

C.6.7.4 The TSP is required to prepare documentation for the detailed calculation of total losses based on measurement during Factory Acceptance Tests of major equipment and systems mentioned above as per relevant IS/IEC/IEEE standards and the same shall be preserved and to be submitted to CEA/CTU/GRID-INDIA, as per their requirement. Further for equipment/systems, whose loss measurement cannot be done during Factory Acceptance Test, the same can be measured at the site, and a combination of calculation and measurement shall be used to derive the total losses as specified above. During Loss measurement, all fans, and pumps; valve room and control room air-conditioning system shall be switched on. However, redundant fans, pumps and air-conditioners shall be kept off during loss measurement.

C.6.7.5 During the factory tests the losses for the following equipment shall be measured/assessed as detailed below:

Coupling transformer:

Losses shall be measured at factory/lab at the maximum rating, at power frequency as per relevant IEC/IS under below mentioned conditions:

- i. No load loss (Iron loss) at rated voltage and fundamental frequency.
- ii. Load loss (copper loss) at rating corresponding to maximum continuous current and at 75 °C.
- iii. Transformer cooling equipment's loss (Auxiliary loss) at rated voltage and fundamental frequency.

Reactors:

The losses shall be measured at the factory/lab at the maximum rating at power frequency as per relevant IEC/IS.

VSC Valves:

Converter losses comprise the losses in power electronic switches [insulated gate bipolar transistor (IGBT) or equivalent], made up of conduction and switching losses, and the losses in DC capacitors, resistors, and inductors used within the converter system. Refer IEEE-1052 for calculating VSC losses.

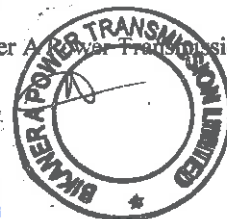

Capacitor:

The capacitor losses shall be measured at the manufacturer's works at power frequency as well as calculated to obtain the losses in the complete bank on the basis of factory measurement.

Auxiliary System:

Aux. power losses shall be calculated from the kW and efficiency of all motors (name plate rating) of the cooling system, air conditioning, ventilation etc. The higher of the total losses for the entire auxiliary systems occurring at full capacitive capacity MVAR or full Inductive MVAR as the case may be shall be considered for arriving at the total losses.

Harmonic Filters, if any:

The losses shall be calculated at the maximum STATCOM Station loading at 400 kV and 50 Hz.

The calculations shall be on the basis of the tested results of the components.

C.6.8 Selection of Insulation Levels

C.6.8.1 Arresters:

Protective levels of arresters connected to the 400 kV AC Bus Bars of the STATCOM Station shall be coordinated with the insulation and surge arrester Characteristics of the 400 kV AC systems to which the STATCOM Station is to be connected. The specification and characteristics of the surge arresters installed in 400 kV AC system is given in the Substation specifications. The front of wave (FWWL), lightning impulse (LIWL) and switching impulse withstand levels (SIWL) shall be determined by the following margins:

- a) A SIWL at least 1.15 times the switching impulse protection level.
- b) A LIWL which is an IEC standard level corresponding to the SIWL and shall be at least 1.25 times the lightning impulse protection level.
- c) A FWWL which is at least 1.25 times the front of wave protection level.

In addition to the above minimum basic requirement, the various insulation level of 400 kV equipment shall be as below. The STATCOM Station equipment, coupling transformers etc. shall be co-ordinated accordingly.

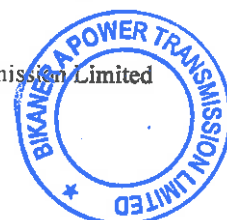

Description	SIWL	LIWL
All equipment including Transformer Bushing and winding	1050 kVp	1425 kVp

C.6.8.2 Valves

The requirement of insulation levels of the valves shall be as per the design requirement.

C.6.8.3 Air clearances

The air clearances shall be determined by the TSP based on the required withstand levels for all waveforms in order to limit the probability of flashover within the STATCOM Station to a target value of one flashover in 15 years.

C.6.8.4 Switchyard

The air clearances for switchyard equipment shall be equal to or greater than the minimum values as specified in IEC-60071. Altitude correction factor (if any) shall also be considered as per IEC.

C.6.8.5 Leakage distances

The Creepage/leakage distance across insulation shall be determined by the TSP and shall be adequate to ensure that under conditions of heavy pollution, the probability of a flashover of an insulator does not exceed one in 15 years. However, the leakage distance for all AC insulators for outdoor installation shall not be less than 25 mm/kV of the maximum operating phase to earth rms voltage at the insulator. The leakage distance of equipment connected to 400 kV systems shall not be less than 10500 mm.

Specific creepage distance for outdoor bushings, insulator strings and long rod insulators shall be a minimum 31 mm/kV.

C.6.9 STATCOM Station availability and reliability

The following definitions apply:

C.6.9.1 Outage terms:a) **Outage**

The stage in which equipment is unavailable for normal operation due to an event directly related to the equipment which results in a reduction in STATCOM Station capacity.

Central Transmission Utility of India Limited

143

Bikaner Area Power Transmission Limited

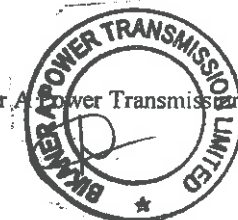
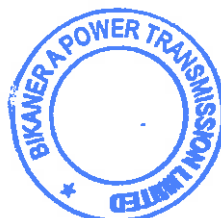
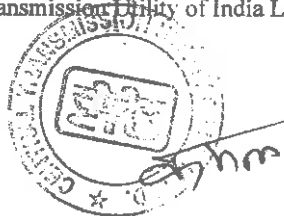

b) Scheduled Outage

An outage that can be scheduled at least one week in advance.

c) Forced outage

The stage in which the equipment is unavailable for normal operation but is not in the scheduled outage stage and which results in a reduction in STATCOM Station capacity i.e. an outage which is not scheduled outage.

C.6.9.2 Capacity terms

Maximum Continuous Capacity (Pm)

The maximum STATCOM Station capacity (MVAR) for which continuous operation under normal conditions is possible.

C.6.9.3 Outage duration terms

Actual outage duration (AOD)

The time elapsed in hours between the start and end of an outage.

C.6.9.4 Time Categories

a) The number of hours in the reporting period in a full year, the period year is 8760 hours. If the equipment is commissioned, part way through a year, the period hours will be proportionately less than 8760 hours.

b) Total Outage hour (TOH)

The sum of all outage duration within the reporting period. $TOH = AOD$

C.6.9.5 Availability and Reliability Terms

Unavailability:

Unavailability is the duration for which the STATCOM Station is not available with a specified rating due to forced outages per year. If part of the station is unavailable, then the unavailability duration shall be counted proportionally. However, if STATCOM is out then its duration shall count as a fully unavailable STATCOM Station. However, If the STATCOM unit is out then the STATCOM Station unavailability shall be counted proportionally to STATCOM capacity. STATCOM Station Control system outage shall count as full STATCOM Station unavailability.

'OF' is the outage frequency which will be the number of forced outages per year.

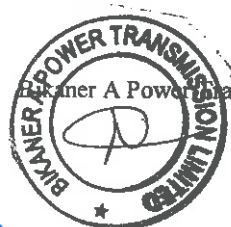
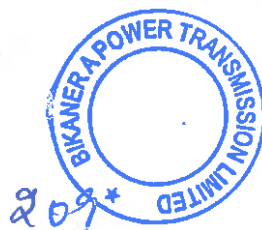
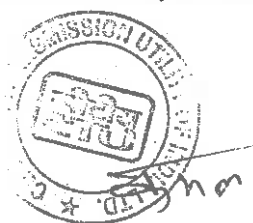

The period basis for availability and reliability calculations shall be 12 months. The TSP shall ensure that the design will meet the specified guaranteed and design target value of availability and reliability.

Outage times for repair, maintenance and replacement of components shall be based on the premise that all items in the list of recommended spare parts are on hand, and that all maintenance schedules of recommended maintenance are adhered to. Reliability calculations shall be made and shall be presented as the expected frequency of unscheduled loss of STATCOM Station capacity. For simultaneous occurrence of events, for either of which a loss of capacity would result, the longer repair time shall be counted.

The facilities shall be assumed to be utilized 100% of the time at 100% load, regardless of the actual reactive power generated/absorbed by the STATCOM Station. Hence the availability and reliability assessment will be based on the capability of STATCOM Station to generate/absorb the rated reactive power regardless of whether, it is in service or not.

C.6.9.6 Availability Requirement

The calculated availability of the system considered on an annual basis shall be equal to or exceed the following target values.

Minimum availability requirement of each complete STATCOM Station

- Guaranteed for STATCOM Station - 98%

The outages of STATCOM Station capacity caused by the failure of equipment outside the scope of the TSP shall not be considered for the calculation of availability and reliability guarantee. However, such outages shall be restricted to

- 1) Complete loss to 400 kV supply (at PCC)
- 2) Human Error.

Circumstances causing curtailment of STATCOM Station capacity that will be included in reliability and availability assessment and which can lead to forced outages shall include but not be limited to the following:

- a) Failure of equipment
- b) Mal-operation of control and protection system
- c) Failure to start
- d) Reduction in capacity.

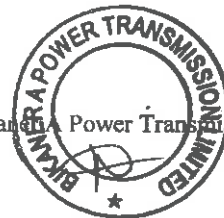
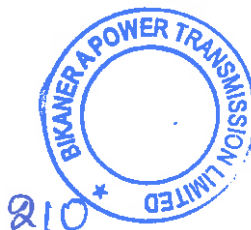
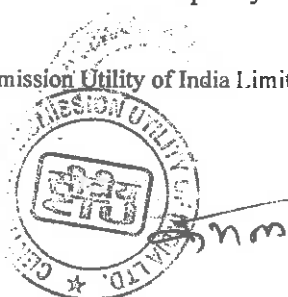

C.6.9.7 Reliability Requirement

a) Reliability

In the assessment of reliability, the following events shall also be considered to constitute a STATCOM Station outage:

- i) A STATCOM Station shut down.
- ii) A reduction of STATCOM Station capacity due to an outage of any component of STATCOM Station

The calculated reliability of the complete STATCOM Station shall be equal to or exceed the following design target values.

The average outage frequency per year for each STATCOM Station shall not exceed the following values:

	Design target for STATCOM Station	Max acceptable Guaranteed value for STATCOM Station
Total Number of Forced Outages	3 x Nos. of STATCOM Station	5 x Nos. of STATCOM Station

C.6.9.8 GUARANTEED FAILURE RATE OF Sub-modules. (Including all components and electronic). The maximum annual guaranteed failure rate of sub module (including all components and electronic) shall not exceed 1.0% per STATCOM. The failure rate shall not include failures directly attributable to operation and maintenance errors.

C.6.9.9 GUARANTEED VALUE OF FAILURE RATE OF AC POWER CAPACITOR

The maximum guaranteed annual capacitor failure rate shall not exceed 0.15% except for first unit failure. The capacitor shall be considered as failed if its Capacitance value varies more than $\pm 5\%$ of the (actually measured) name plate value. Leakage of oil from the capacitor and the deformation of the capacitor unit shall be considered as a failure even if the capacitance value is within the tolerance limits.

C.7 Design Principles

The objective for the design of the STATCOM Station shall be to achieve a high level of availability and reliability as specified. Special attention shall be given to designing the STATCOM Station to avoid forced outages. The TSP shall conduct thorough design reviews to ensure the minimum risk of such outages. The TSP shall give careful attention to related factors affecting STATCOM Station performance such as

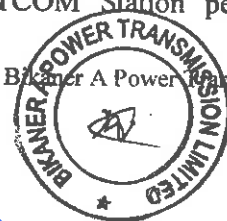
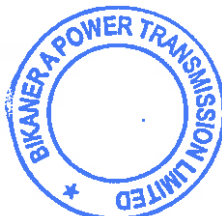

subsystem and system testing, protective relays co-ordination and proper setting of relays.

Except where greater reliability requirements are specified in these specifications, the design basis for STATCOM Station shall be such that no single contingency downstream from the medium voltage bus shall cause a total outage of the STATCOM Station. The following general criteria shall be followed for the design of the control system:

- a) Use of components similar to those whose reliability has already been proved in use.
- b) Use of good design practices, surge protection, filtering, and interference buffers to assure Immunity to sensitive components and circuits against damage and interference by induced voltages and currents in the external cabling and cubicle wiring.
- c) Use of fail-safe and self-checking design features.
- d) Use of component and equipment redundancy, by means of either duplication or triplication with automatic transfer facilities wherever necessary to meet the requirement of these specifications.
- e) Design which in the event of component failures, provides for transfer to a less complex operating mode.
- f) Provision of alarm, fault diagnosis and indication

C.8 STATCOM Station Main Components

C.8.1 STATCOM Unit

The main electrical data of the STATCOM Units are the following:

- | | |
|---|----------------------------------|
| o Rated voltage | 20 kV Minimum |
| o Rated frequency | 50 Hz |
| o Redundancy (Sub Module) | 2 Nos. or 5% whichever is higher |
| o Rated Power of each STATCOM unit/Branch | ± 50 MVAR Minimum |
| o Valve Cooling | Deionized/Demineralized water |

In general, the STATCOM units shall equally share the load however under contingency conditions it should be possible to run the units with unequal load. Charging of the DC capacitors of Sub module during the initial start-up shall be achieved by means of Resistors and bypass breaker arrangement. The charging resistor

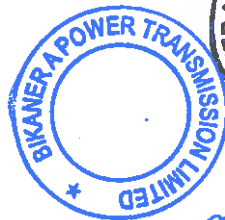
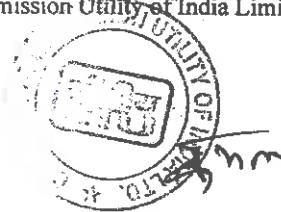

for DC capacitor of the STATCOM Sub module should be designed for three charges per hour followed by the appropriate cooling time. Power for the gate level control shall be derived internally from Sub module. The offered STATCOM Units with their Control system shall be suitably located inside the STATCOM Station Building.

C.8.1.1 STATCOM Valve

The valve shall be designed to meet the performance requirements described in this specification and as described below.

In order to ensure a modern low loss and reliable solution, the STATCOM valve assembly shall use the multi-module (including redundant sub-modules) approach.

The valves shall be designed to ensure satisfactory operation according to the overall performance requirements and include all necessary auxiliary equipment required for smooth and reliable operation. The valves shall be indoor air-insulated and cooled by de-mineralized water. The valves shall be of modular design and have removable Sub-Module for ease of maintenance. The valves shall be mounted to allow easy access for visual inspection, routine maintenance and replacement, and facilities shall be provided to enable easy access.

C.8.1.2 Semiconductor Switches

The electronic switches should be designed with the aim to achieve operation according to the overall performance requirements of the STATCOM Station. The valve shall be designed with individual semiconductor switches applied in a conservative manner with regard to their basic design parameters. The semiconductor switch shall meet the requirements of IEC 60747 except where otherwise specified herein.

The semiconductor switches shall be designed to withstand all stresses expected under steady state, transient and temporary overvoltage conditions. Basic semiconductor devices shall be of the Press Pack type, or packaged to provide short circuit means in case of device failure such that the STATCOM can continue to operate without interruption. The adjacent sub-module should be protected against the possible explosion of the semiconductor switch.

Under the restriction of redundancy (minimum two or 5% whichever is higher) i.e., the failure of any semiconductor switch or sub module or monitoring device etc shall not prevent continued system operation. In the event of any of the above failures, the STATCOM shall annunciate and identify the specific location of the failed device and

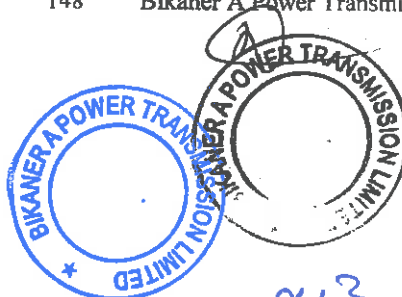
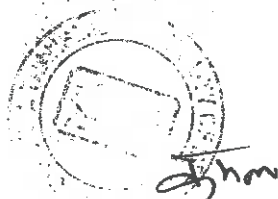

continue operation until such time as repairs can be scheduled. During such time the next shutdown can be averted, the STATCOM must continue to operate without downgrading STATCOM capability.

The switching device's design should include an appropriate allowance for unequal voltage distribution across individual devices in the valve due to the stray capacitor and component tolerances.

The switching device's design should include an appropriate allowance for unequal voltage distribution across individual devices in the valve due to the stray capacitor and component tolerances.

Each switching device should be able to operate within component ratings, generally with at least two failed sub-module or levels. The number of possible failed sub-modules or levels as specified shall be consistent with the availability requirements of the STATCOM system.

C.8.1.3 Sub module for Multi-Module Topology

The key element of the multi-module topology shall be the sub-module. By increasing the number of these sub-modules, it is possible to obtain high voltage with extremely low harmonic distortion and very low dv/dt using a low switching frequency that reduces power losses. Sub-module shall have the following characteristics:

VSC sub-modules should be protected against over voltages with appropriate strategies. A description of the failure mode of the switching device and the strategies used for failure should be provided.

In each fiber optic cable (having multiple fiber cores) used for control/communication purposes of sub-module at least two fiber cores shall remain available as spare for future use.

C.8.1.4 The STATCOM sub-module has DC capacitors that require a charge to allow full functionality and performance. At the startup of the STATCOM Station, the capacitors are discharged. During the energization sequence of the STATCOM, Capacitors are charged from the main power grid via resistor operated in series to the main connection circuits. Once the desired charging voltages are reached, the charging resistor circuit is bypassed using a bypass switch/breaker.

The Type and Rating of the charging resistor and associated bypass switch shall be designed with the aim to achieve operation according to the overall performance requirements of the STATCOM Station and shall conform to the relevant Standard.

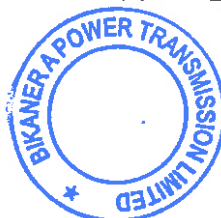
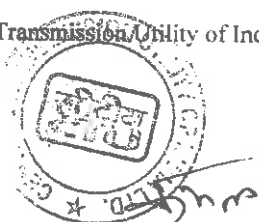

C.8.1.5 STATCOM Valve Cooling System

A closed-loop recirculating system shall be provided with full heat rejection capacity with redundancy for pumps, heat exchangers, and fans, appropriate to the STATCOM Station availability requirements. The cooling system should be able to maintain full capacity at maximum ambient temperature and maximum STATCOM reactive power output. The cooling system should be able to operate at the lowest ambient temperature and zero output specified. The Valve cooling system shall have black start capability and necessary Uninterruptible Power Supply (UPS)/ Uninterruptible Motor Drives (UMD) shall be provided separately for each STATCOM Unit.

The valve cooling system shall be designed to meet the performance requirements described in this specification and as described below.

- a) Each STATCOM Unit shall have its own de-ionized water valve cooling system with redundant pumps.
- b) For cooling the STATCOM valves, a deionized re-circulating (closed loop) water system shall be used.
- c) Water to air heat exchanger shall be used for cooling of this de-ionized water. Water to water heat exchanger shall not be employed.
- d) System shall be designed such that no shut down of STATCOM be resorted to for making up the deionized water in the system. The make-up water should comply with the recommended pH and purity.
- e) Cooling water shall have a constant flow rate irrespective of loading. The flow rate shall be decided on the basis of extreme operating conditions.
- f) The control system for the cooling system shall be redundant type including the provision of redundant control supply and main power supply. However, in place of the redundant control system for the cooling system, suitable alternate mode is also acceptable meeting the requirement of fulfilling cooling system operation even if failure of cooling control system.
- g) 2x100% pumps with one as standby shall be provided for the primary. Should a pump failure occur, the second pump should automatically switch in without shutting down the STATCOM. An alarm shall be displayed at the control panel for the failure of the first pump and standby pump in operation.
- h) Each cooling system shall be provided with an independent/dedicated UMD supply however common battery for both UMD power supply may be accepted. An UMD system will provide an extended capability of the STATCOM Station to deliver reactive power without any interruption, adding a buffer against the system faults or during events such as delayed voltage recovery or Transient over Voltage (TOV).

Central Transmission Utility of India Limited

150

Bikaner Power Transmission Limited

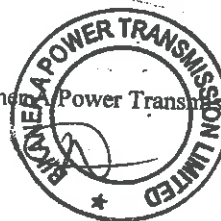
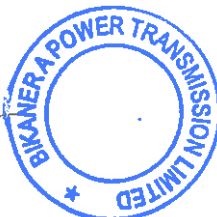

215

- i) The secondary cooling system shall be a redundant type such that it shall be possible to take out 10% (minimum one number) of the cooler module (fan unit) of secondary cooling system without affecting the rated performance of STATCOM).
- j) Normally no make-up water shall be required however in case of expansion vessel level going low; the same shall be replenished automatically by means the of make-up water tank and make up water pump to be supplied with the system.
- k) TSP shall provide a water treatment plant of sufficient capacity. The purification (treatment) system shall be designed to maintain conductivity below 1 micro Siemens. A resistivity cell in the outgoing water from the deionizer should detect the depletion of ionized material. Filters and deionizers shall be designed to allow replacement during operation. Normal replacement shall not be required more than once every year.
- l) Filters and deionizer/deoxidizer material shall be designed to allow replacement within minutes without shutdown of the cooling unit. (Normal replacement should not be required more than once/year).
- m) Primary cooling system shall monitor its own operation and condition of cooling water.
- n) The protection system of the cooling cycle shall have minimum following alarms:
 - i) Depleted deionizing cell
 - ii) Low water resistivity
 - iii) High water temperature
 - iv) Primary pump stopped
 - v) Fan stopped
 - vi) Primary pump or fan interlock circuits faulty
 - vii) Primary cycle (Make-up water) tank level low
 - viii) Failure of control supply.
 - ix) UMD/UPS fault.
- o) Following shutdown alarms / TRIP shall be provided with cooling system protection. Excessive low water resistivity Excessive high water temperature, complete loss of auxiliary supply to primary pumps, low flow, Low Pressure etc.
- p) The dissipative components of the converter are cooled with deionized water.
- q) The power losses are transferred to the external ambient by means of a deionized water /air heat exchanger. All the piping and other components Complete instrumentation set have been mounted on board in order to check the status of the cooling system:
 - Conductivity gauge system.
 - Flow meter equipped with two set points (alarm and trip).
 - Pressure meter
 - Two thermometers for the inlet and two thermometers for the outlet (two set

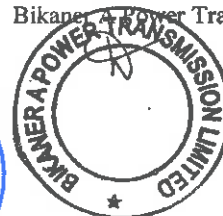
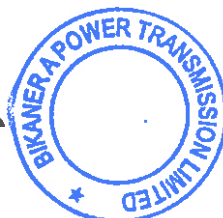

- points for alarm and trip)
- Thermostat
- r) The status of the cooling system is monitored by means of the control system.
- s) Replacement of certain cooling equipment (e.g. pumps, fans, cooler unit etc.), if defective, should be possible while the cooling system still operates.

C.8.1.6 Tests on STATCOM Unit Valve

All applicable tests i.e. Operational Type Tests, Dielectric Type Tests and Test for valve insensitivity to electromagnetic disturbance and Production tests shall be done as per the latest edition of IEC 62927.

C.8.2 STATCOM Station Control equipment and operator interface

C.8.2.1 Control Equipment

The control systems should achieve the functional objectives given in 6.2. The accuracy of voltage should be within $\pm 1\%$ of the reference voltage. The accuracy of the gradient and linearity of the slope delivered by the STATCOM Station should be defined in relation to the current deviation from the theoretical slope defined in 3.1. The maximum deviation should be less than $\pm 5\%$ of the nominal current.

The control system design shall be based on a single fail criterion i.e. failure of any one component in the system should not result into outage of the complete system. As a minimum, a dual (hot standby) digital programmable controller shall be supplied for each STATCOM unit/branch and STATCOM Station to control the STATCOM, MSRs and MSCs completely including the functions listed as mentioned below:

- a. The controller shall have diagnostic and self-checking features for both itself and for valves, gate firing and drive circuits, interface hardware, and software. This is required to reduce outage times and to facilitate fault finding.
- b. The Controller shall be reprogrammable. The Owner shall have at least the following possibility for changing the following reference and limit values via HMI:
- c. Closed loop Controllers:

The STATCOM Station controller shall have the means to modify the reference set points. This refers to the functionality that will allow all the control parameters to be adjustable within selectable limits and is inclusive of, but not limited to following:

- o Voltage controller
- o Q controller (reactive power controller).
- o Supplementary VSC current controller.
- o Other supplementary control functions.

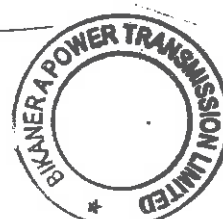
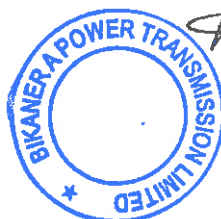

- d. Sequence Controllers:
The sequence control and open-loop controllers shall include the control of all switchgears and associated control gear and external devices.
- e. The Controller shall have at least 10% excess I/O capacity to allow future program upgrades to satisfy the changing requirements of the power systems or future extensions to the STATCOM Stations. As a minimum, a control of up to 4 future HV shunt devices (reactors or capacitors) shall be included in the offer.
- f. All control signals available for remote control must also be available locally so as to ensure that a local operator can operate the STATCOM Station if the communications link between STATCOM Station and remote control centers is lost.
- g. A changeover switch shall be provided for control of the selection of local or remote control.
- h. TSP shall provide the equipment necessary for the purpose of control, protection and interlocking of all equipment within the scope of supply.
- i. TSP shall be responsible for the design and coordination of control, protection and interlocking system and switching sequences within the STATCOM Station. All necessary interfacing required between AC switchyard equipment and STATCOM Station for the above purpose shall also be included in the scope of TSP.
- j. It is proposed to control STATCOM through a Supervisory Control and Monitoring System (SCADA). All the data shall be acquired through suitable means from the field and various components and control is executed through the redundant HMI. The local STATCOM Station Control system shall consist of a redundant STATCOM Station controller, redundant HMI workstation, Gateway, STATCOM Station Control System Engineering cum Disturbance Recorder (DR), PC which can also be used as standby HMI workstations in case of emergency with associated peripheral equipment such as color laser log Printers, Color laser jet fault record printer, GPS System, Inverter / UPS etc. all interconnected via redundant Ethernet based Station LAN Network. Each workstations and PCs at STATCOM Station shall have at least 19" LED display.
- k. In addition to the above, HMI workstation (identical to HMI Workstation provided in the STATCOM Station control room) should also be provided in the control room of the main 400 kV substation. This HMI workstation should be powered from an independent UPS system adequate enough to provide power to the HMI workstation for a minimum two hours in case of auxiliary power failure.
- l. The control equipment shall satisfy the reliability and availability requirements specified in this specification
- m. All necessary measures shall be taken to ensure satisfactory operation in the presence of harmonic current and voltage, noise and radio interference signals. The equipment shall be designed to operate in the environmental conditions specified in the specification.

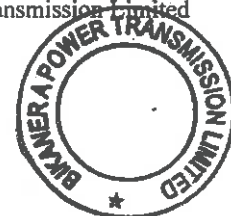
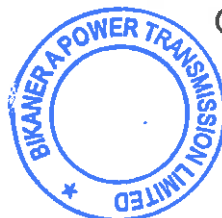

- n There should be a provision for independent operation of MSC/MSR after delinking it with STATCOM controls when STATCOM is out of service due to any reason.
- o. The threshold values for switching the MSC/MSR on/off shall be configurable in all modes of operation.

C.8.2.2 Operator Interface

- a) Each STATCOM Station shall have a SCADA consisting of an HMI which shall provide a Centralized (local) operator control of the STATCOM Station functions. All human interface operations necessary for the control and monitoring of the STATCOM shall be provided at this point.
- b) Any abnormal condition requiring operator action or intervention or maintenance on any of the STATCOM Station subsystems shall be annunciated at the STATCOM Station control room and the Substation control room.
- c) The local HMI shall include the following diagrams as different screens in the display system:
 - i. Complete STATCOM Units and STATCOM Station single line diagram including EHV and MV buses
 - ii. AC Auxiliary supply and distribution
 - iii. DC Auxiliary supply and distribution
 - iv. STATCOM Valve cooling systems
 - v. Interlocking system.
- d) These diagrams shall indicate status, alarms, voltages, currents, etc. The HMI shall provide complete diagnostics on alarm and trip indications as required and discussed in this specification, including SER information.
- e) A facility shall be provided whereby the local HMI features and functions shall be accessible from remote. A remote user shall be able to view screens and change STATCOM Station parameter settings.
- f) As Bikaner-IV substations where STATCOM Station shall be installed, will be equipped with Sub-station Automation System (SAS) conforming to IEC 61850, it is required that STATCOM Station control and monitoring shall be integrated with SAS already provided at the main 400 kV Sub-station by the TSP. It is proposed to connect STATCOM Station's SCADA with SAS through a Gateway and the database, configuration etc of the main substation SAS shall be upgraded to incorporate STATCOM Station events, alarms, Controls (both switchgear and control functions of STATCOM Station like the setting of parameters etc.) so that STATCOM Station can

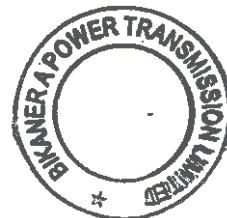
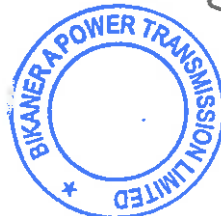
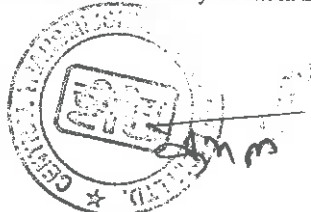

be effectively monitored and controlled from main substation SAS and shall be monitored from Load Dispatch Center (WRLDC).

C.8.3 STATCOM Station Protection System

C.8.3.1 Protection system Design

- a) To ensure that faults are cleared within stability critical clearing time, to minimize damage to the plant, and to avoid voltage collapse, loss of load, or load limitations, TSP shall provide a high speed main protection scheme. An independent (having a separate measurement system) back-up protection scheme shall be provided in the event of the main protection scheme failing or taken out for maintenance.
- b) The STATCOM Station shall be completely self-protecting (unit protection). STATCOM Station shall be protected from damage for all conditions of over-current, overvoltage, excessive reactive power loading, unbalance due to loss of capacitor elements, phase-to-phase and phase-to-ground faults, three phase faults, loss of cooling, semiconductor valve or control malfunction, faults (STATCOM, MV system) in individual primary connected components of the STATCOM, HV system faults, etc. The STATCOM Station shall withstand the maximum fault current for a period of the maximum fault clearing time as specified, considering second contingency cases due to the previously mentioned conditions.
- c) All protection equipment and systems should be properly co-ordinated to prevent incorrect operations of the protection equipment or systems during normal STATCOM Station operation, including anticipated abnormal conditions on the transmission system, as specified. Fail-safe principles should be applied throughout.

C.8.3.2 The basic principle and order of precedence for the control and protection shall be, to take care of the following:

- Correctly identify a fault, problem or error condition,
- Only if necessary, isolate the minimum number of components, subsystems whenever possible,
- Utilize degraded modes to the maximum extent possible either directly (no interruption of the STATCOM Station operation) or indirectly (by tripping the STATCOM Station momentarily in order to isolate the branch and re-energization of the STATCOM Station).
- Trip STATCOM Station and Block.
 - a) Failure of the STATCOM Station Interface (SCADA interface) shall not result in a Protection trip of the STATCOM Station. A fail-safe philosophy shall be implemented to allow the STATCOM Station to operate safely and independently from the STATCOM Station Interface (SCADA interface).

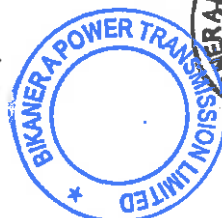

- b) Protection equipment shall be designed and applied to provide maximum discrimination between faulty and healthy circuits.
- c) The Protection shall be sufficiently sensitive to cater to the full range from maximum to minimum fault level conditions. The Protection shall also be suitable for a system fault level equal to the maximum short circuit capacity of the substation. All current transformer designs shall be based on these fault levels.
- d) All required protective, control devices, etc including auxiliary instrument transformers and panels, relays, cabling, wiring, indication, and all other associated plant and material necessary for the effective operation of the protection systems shall be supplied and installed by TSP.
- e) The protective relays shall be microprocessor based. Relays shall have approved characteristics and be mounted in dust and moisture-proof cases. The protective relays shall be provided with visual indications for starting, tripping and failure of the protective function. The LEDs shall be reset without opening the covers. The protection relays shall also be equipped with HMI facilities suitable for manual parameter settings and viewing of the settings. Relays with provision for manual operation from outside the case, other than for resetting, are not acceptable. Relay settings shall be visible and readable without having to remove the relay cover. Relays shall be of approved construction and shall be arranged so that adjustments, testing and replacement can be effected with the minimum of time and labor. Auxiliary Relays of the hand reset type, if provided shall be capable of being reset without opening the case. Electrically reset tripping relays shall be provided as necessitated by the system of control, such as for those circuits subject to remote supervisory control.
- f) Relay contacts shall be suitable for making and breaking the maximum currents which, they may be required to control in normal service but where contacts of the protective relays are unable to deal directly with the tripping currents, approved Auxiliary tripping relays shall be provided. In such cases, the number of auxiliary tripping relays operating in tandem shall be kept to a minimum in order to achieve fast and reliable fault clearance times. Separate contacts shall be provided for alarm and tripping functions. Relay contacts shall make firmly without bounce and the whole of the relay mechanisms shall be as far as possible unaffected by vibration or external magnetic fields
- g) Steps shall be taken to protect the circuitry from externally impressed transient voltages which could reach the circuitry via connections to instrument transformers or the station battery. The routing of cables should be such as to limit interference to a minimum. Any auxiliary supplies necessary to power solid-state circuits shall be derived from the main station battery and not from batteries internal to the protection.

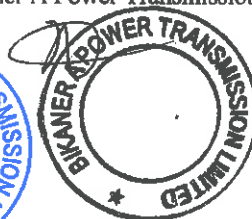
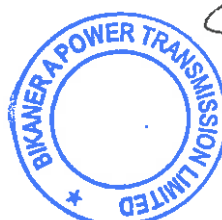
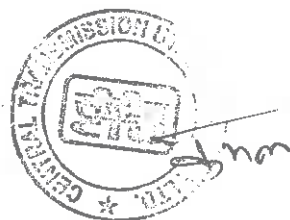

h) **Relay communication**

The Relays shall also have a communication port provided on the front of the relay for configuration and parameter settings as well as downloading of data. A direct port suitable for remote communication shall also be provided at the back of the Relay. This port shall conform to IEC - 61850.

i) **Tripping schemes**

- Tripping of MV circuit breakers shall be done by means of two-separated trip signals.
- Duplicate high security tripping circuits for MV Circuit Breaker shall comprise two independent high speed (less than 10 ms) high burden (greater than 150 W) tripping relays for each circuit, each with its own independent DC supply. The trip circuits for all circuit breakers need to be equipped with a "lockout" function and it shall be possible for this to be reset manually and remotely by the operator.

j) The protection for the power system is based on a normal switching state and an occurrence of a single fault. This means that faults resulting from maintenance as well as the simultaneous occurrence of two or more faults are not taken into account.

k) The input circuits of the digital protections shall be monitored by means of a plausibility check. If any incorrect information is found, the protection function shall be blocked by the protection system. All protection relays shall have facilities for monitoring trip circuits. Detection of an interruption in the case of a switched on circuit breaker shall be signaled.

l) **Test facilities**

- It shall be possible to test the protective device during operation without causing trips. Links shall be provided for the isolation of individual protection trip circuits and the common protection trip circuit to each circuit breaker trip coil.
- Separate test facilities shall be provided for each current and voltage transformer secondary circuit so as to give access for testing of protection relays and associated circuits. The Test facility to be supplied shall have two selectable positions, a Service and a Test position. In the service Position, the test switch connects CTs and VTs signals to the Relays and trip commands to the circuit breaker trip coils. In the Test Position, the test switch applies a short-circuit to the Current Transformer (CT) secondary windings and open circuits the VT secondary cores and allow injection of secondary current and voltage into the relay. At the same time, the Trip commands to the Circuit Breaker Trip Coils are isolated. The test switch supplied shall be to the Approval of the Owner.

m) The protection of the electrical system shall be designed and installed in such a way that the failed equipment is disconnected selectively and automatically.

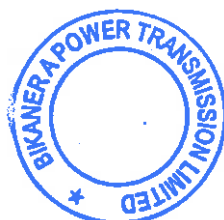
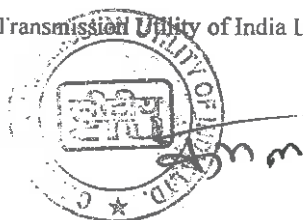

DA

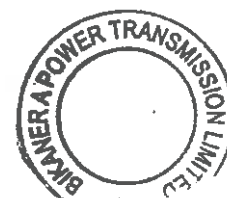

222

All equipment have to remain operative during transient phenomena, which may arise during switching or other disturbances to the system.

- n) **Auxiliary DC Supplies**
- The protection concept has to be designed in a way so that back-up protection is provided at all times. All protection relays shall be configured in a way that failure of one Auxiliary DC system will not affect the relay. If all DC supplies to the controllers are lost, the STATCOM Station breaker must be tripped via the protection panel.
- o) **Electromagnetic Compatibility**
- Electronic Relays and other electronic devices and the ancillary circuits connected to them, such as power supplies, current and voltage transformer secondaries, status or tripping or alarm circuits shall be designed to ensure that they are compatible for use in the hostile electrical environment found in an MV or HV substation.
 - Adequate steps by means of suitable design, shall be taken to prevent Electromagnetic Interference (EMI), (generated by sources such as circuit breakers, disconnectors, lightning, radio or radar emissions, switching contactors in DC circuits etc) or Electrostatic Discharges (ESD) from affecting relay performance or causing damage to components.
 - All relays offered shall therefore have been type-tested to meet the current requirements of IEC Standards with respect to High Frequency disturbance, Fast Transients, Electrostatic Discharge, Radio Frequency Interference testing etc.
- p) **List of Protection functions for STATCOM Station**

Coupling Transformer Protection:

- i) Biased Differential protection (87T)
- ii) REF protection (64T)
- iii) Overcurrent protection (50, 51)
- iv) Ground Overcurrent (51N)
- v) Over flux protection (HV and MV)
- vi) Transformer mechanical trips

STATCOM MV Bus Protection:

- i) Bus Differential protection (87)
- ii) Ground over current protection (51N), used with a neutral Grounding Transformer
- iii) Under / Over Voltage (59 Ph-Ph) protection
- iv) Over voltage (Open Delta) protection

STATCOM Branch Protection:

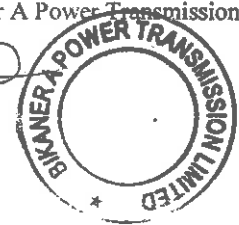
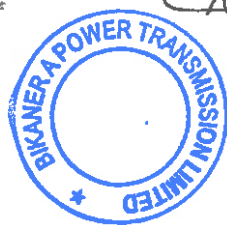
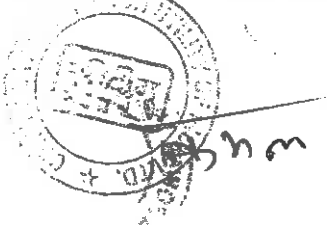

223

- i) Differential protection (87)
- ii) Overload protection (49)
- iii) Overcurrent protection inside delta (50, 51)
- iv) Negative phase sequence protection (46)
- v) STATCOM branch overcurrent protection (50, 51, 50N, 51N)

MSR Branch Protection:

- i) Differential protection (87)
- ii) Ground over current protection (51N)
- iii) Reactor branch unbalance protection (Negative Phase Sequence)
- iv) Thermal Overload protection

MSC Branch Protection:

- i) Ground over current protection (51N)
 - ii) Capacitor Overvoltage (Using current signal) protection.
 - iii) Capacitor unbalance protection (60C)
 - iv) Over current protection (50, 51)
- The protection functions listed above are the minimum set of function to be provided, any additional protection required to fulfill the requirement of the protection system shall also be provided.
 - Further protection functions of individual branch (STATCOM, MSC, MSR) shall trip the respective branch MV CB (Circuit Breaker).
 - All CBs shall be provided with individual Breaker Failure protection relays. Breaker Failure relay shall have the logic based on the current signal or CB close open status.
 - Any fault on MV bus will trip the 400 kV breaker. However, any branch fault shall be cleared by the respective MV branch Circuit Breaker.
 - Protection System for the STATCOM valve portion of the STATCOM station shall be provided in the redundant controllers to isolate the STATCOM valve during internal overload/overvoltage, ground fault etc.

C.8.4 STATCOM Station Fault Recording System

An integrated Transient Fault Recording (TFR) System shall be supplied, installed and commissioned. This shall include trigger level settings for analog signal, etc subject to review and comment. Disturbance and event recording facilities are required for local monitoring of the STATCOM following a disturbance on the power system or the STATCOM System. The TFR shall be GPS synchronized.

The following inputs are required:

- All analog signals (output signals) including 3-ph and sequence values of

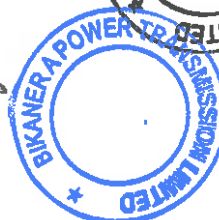

224

voltage, current.

- All digital signals (control outputs, status indications, commands, alarms, and trip indications). Internal STATCOM Station control signals variables to be selectable.
- The accuracy of the TFR for event inputs shall be at least 100 μ s (sampling rate of minimum 10 kHz).
- The TFR shall have provision for remote access and retrieval of recorded information onto a PC. For this purpose, a communication link to the substation LAN shall be implemented.
- The remote software application for data retrieval shall be included.
- There shall be multiple channels to view 3-ph and sequence values of voltage, current.
- TFR file shall be viewable in any open source software.

C.8.5 Mechanically Switched Reactor (MSR)

MSR is a fixed source of inductive reactive power connected in shunt to the MV bus of STATCOM Station and switched by means of a circuit breaker (with a control switching device) based on the command from the STATCOM Station control system. The rated capability of MSRs shall be at 400 kV (Referred to as "Point of Common Coupling" or PCC) and in the steady state frequency range of 48.5 Hz-50.5 Hz. However, The MSR Components shall be designed with the aim to achieve operation according to the overall performance requirements of the STATCOM Station. The individual components of MSR shall be able to withstand the onerous conditions imposed by system overvoltage and harmonics. The MSR consists of 3-ph Air Core Reactor, 3-ph MV Circuit breaker (SF6/Vacuum type), associated current transformer, 3-ph Disconnecter and associated safety grounding switch. The MSR area shall be fenced and a castle key interlock with safety grounding switch shall be provided for human safety.

Specifications for individual components like Air core reactors etc are provided in the subsequent clause.

C.8.6 Mechanically switched capacitor (MSC)

MSC is a switched 3-phase capacitor bank connected in shunt to the MV bus of STATCOM station and switched automatically by means of a circuit breaker (with control switching device) based on the command from STATCOM Station control system. The rated capability of MSCs shall be at 400 kV (Referred to as "Point of Common Coupling" or PCC) and in the steady state frequency range of 48.5 Hz-50.5

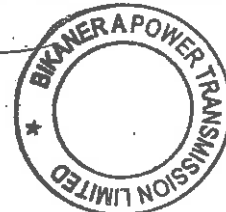
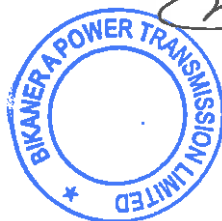
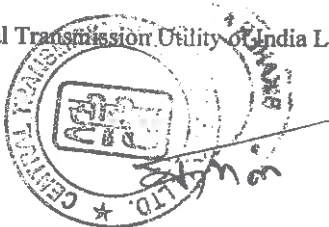

Hz. However, TSP will ensure the corresponding values at PCC (400 kV) for possible operating condition measured at PCC. The MSC Components shall be designed with the aim to achieve operation according to the overall performance requirements of the STATCOM Station. The individual components of MSC shall be able to withstand the onerous conditions imposed by system overvoltages and harmonics. The MSC consists of 3-ph AC power capacitor bank, a current limiting air core reactor as required, 3-ph MV Circuit breaker (SF6/Vacuum type), associated current transformer, 3-ph Disconnecter and associated safety grounding switch. The MSC area shall be fenced and a castle key interlock with safety grounding switch shall be provided for human safety. Specifications for individual components like Capacitors, Air core reactors etc are provided in the subsequent clauses.

C.8.7 Air Core Reactors

- a) Reactors shall be air core, dry type, be suitable for outdoor installation and there shall be no tapping on the reactors. The insulation level shall be adequate and TSP has to ensure proper insulation coordination.
- b) The insulation of the reactor shall be class F and hot spot temperature rise shall not exceed 105 °C above ambient temperature. Winding temperature rise shall not exceed 80 °C above ambient temperature.
- c) The reactor shall be designed to withstand thermal dynamic shocks and mechanical shocks while in service and during erection.
- d) The reactor shall fully conform to the relevant IEC standard.
- e) The reactor shall be designed to withstand overloading due to over voltage as specified and shall also be subjected to excitation by harmonics; the reactor must be able to withstand such events without deterioration in normal life.
- f) The reactors shall be subjected to type and routine tests in accordance with the latest issue of IEC-60076 as appropriate to the type of reactor provided.
- g) Tests on Reactors: The reactors shall be subjected to type and routine tests in accordance with the latest issue of IEC-60076 as appropriate to the type of reactor provided.

C.8.8 AC POWER CAPACITORS

i) General

- a) The capacitor banks shall comprise capacitor units, discharge devices, protection equipment, series reactor as required, earthing switches, suitably connected in series and parallel, mounted at ground level with protected fencing all around. The number, arrangement and connection of capacitor banks shall be designed to suit the

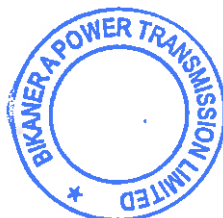
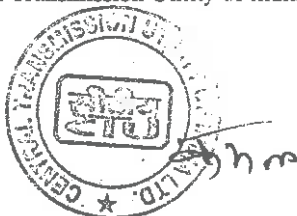

requirement of the compensator as a whole. If convenient, the capacitor banks may be used in conjunction with reactors. In this event, the rating of the capacitor shall be adequate to cope up with the harmonic loading. The frequency variations shall also be considered. To limit the peak inrush current for switching in the capacitors, current limiting reactors with parallel connected damping resistors, if required shall be connected in series with shunt capacitor banks.

- b) The capacitors shall be provided with internal-type fuses. Alternatively, the fuseless capacitor is also acceptable.
- c) Fuses shall not melt nor shall deteriorate when subjected to the inrush current during the life of the capacitor bank.
- d) With the capacitor charged to a peak voltage, the fuses associated with the healthy elements shall not melt when carrying the discharge current resulting from a breakdown of an element or from an external short circuit.
- e) Fuses shall be capable of disconnecting a faulty element over a range of voltage across the unit terminals from $0.9 U_n$ to $2.0 U_n$. In addition, if all the elements in the same row of an internally fused capacitor were to fail as a result of a cascading action, the last fuse element to melt shall be capable of successful disconnection with a voltage of not less than 1.5 times.
- f) After fuse operation the fuse assembly shall be able to withstand continuously at least 1.5 times the rated unit voltage U_n across the gap for 10 Seconds.
- g) Fuses shall preferably be of the current limiting type but fuse system shall in any event be designed to ensure that energy released into a faulty capacitor unit is less than the value that will cause rupture or bursting of the container.
- h) The capacitor units shall be the outdoor type. The container of the capacitor shall be of stainless steel.
- i) Each capacitor unit shall be readily accessible and replaceable without disturbing any other unit. The supporting frames shall be designed to provide adequate ventilation to the units.
- j) The dielectric fluid used in the capacitor unit shall be environmentally safe and biodegradable, non-toxic. Poly Chlorinated Biphenyle (PCB) type dielectric or any of its derivatives shall not be acceptable.

ii) Construction and Design Requirement

- a) The capacitors shall conform to IEC-60871. The capacitors shall be provided with internally mounted discharge resistors with characteristics in accordance with IEC-60871.

Central Transmission Utility of India Limited

162

Bikaner A Power Transmission Limited

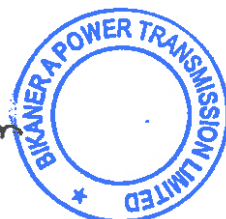
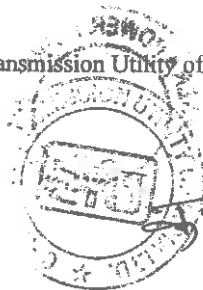

Handwritten signature

Handwritten number 227

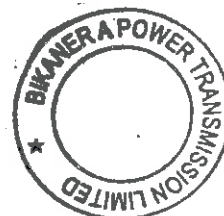

- b) The current limiting reactors (as required) shall be dry type and connected in series with the capacitor bank. Suitable lifting lugs shall be provided.
- c) The capacitor enclosure shall have sufficient strength to withstand without damage or loss of life, mechanical load, both in operation and during erection. The loads shall include electromagnetic forces including those during faults external or internal to the capacitor bank, wind loading, forces due to expansion and contraction caused by ambient temperature and load variation, and seismic effects all as specified.
- d) The capacitor units shall be interchangeable in order to reduce the spare requirements and simplify maintenance procedures.
- e) The capacitor stack shall be vibration free. The stack shall have a fixed potential, which is connected to one electrical point in the bank. The stack shall be of galvanized structural steel.
- f) The capacitor racks shall be supplied complete with all capacitor units, insulators, and connections and shall be equipped with lifting lugs/eyes to facilitate assembly into the stacks. The racks shall be constructed of galvanized structural steel. No drilling of galvanized steel shall be allowed. Each rack shall be labeled with the weight of the fully equipped racks, the phase, and the bank of which it forms a part. The maximum and minimum capacitor unit capacitance which may be substituted into the racks as spares shall be suitably identified. Suitable warning labels shall be affixed.
- g) The capacitor shall be specially designed to be suitable for intermittent duty.
- h) The capacitors should comply with the overload capacity as per NEMA Standard.
- i) The capacitor elements shall be vacuum dried inside the case prior to impregnation with dielectric fluid. After impregnation, the capacitor unit shall be sealed immediately upon removal of the impregnated reservoir.
- j) The discharge resistor shall discharge the unit from peak operating voltage to less than 75 Volts within 10 minutes.
- k) The capacitor case shall be made from type 409 stainless steel or equivalent stainless steel with all joints welded and tested for leaks.
- l) All racks and bus insulators as well as the insulators used to insulate each stack of capacitor from ground level shall be pin-cap or post type. The minimum voltage rating shall be 15 kV and low frequency wet withstand voltage of all insulators used to insulate within or between the capacitor rack of a stack shall not be less than three times the actual voltage stress across the insulators. The insulator shall be outdoor type manufactured from wet porcelain. The insulators shall be bolted to the top members of the frame to support electric-grade aluminum buses.
- m) The size and groupings of the individual capacitor units shall be such that a single blown fuse will not cause the voltage across the parallel group to rise by more than 10%.

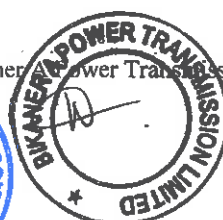
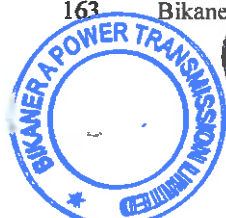

- n) The redundancy to be provided, shall be as per the requirement specified regarding reliability and availability in the clause mentioned elsewhere.

iii) Capacitor Unit Failure Detection

The stages of capacitor units or element failure detection shall be provided as below:

- a) A three-step unbalanced current protection shall be provided in each capacitor bank to initially generate an alarm when the unbalance limit is reached and finally to trip the bank in case of the limit is exceeded.
- b) The first stage shall generate an alarm and the capacitor unit shall continue in service. It may be assumed that the bank shall be disconnected for maintenance within 2 weeks.
- c) The second stage shall generate a separate alarm and a delayed trip signal which will disconnect the bank after two hours.
- d) The third stage shall cause immediate disconnection of the Capacitor Bank.

iv) Tests on Capacitors

All the tests on capacitor units shall be in accordance with the latest issue of IEC 60871.

C.8.9 Coupling Transformer

The TSP shall provide single phase coupling transformers to operate as 3- phase bank with one unit as a common spare (cold spare) with necessary auxiliary arrangements for stepping down the voltage from 400 kV system to a suitable medium voltage value as required for replacing any one of the faulty phase units without physically shifting the transformer. The Medium Voltage side of the coupling transformer to couple with the STATCOM shall not be less than 20 kV to ensure optimum power transformation.

The Coupling Transformer shall be designed with the aim to achieve operation according to the overall performance requirements of the STATCOM Station. The transformer should be designed and rated to carry complete capacitive and inductive reactive loading as specified for STATCOM Station including that of mechanically switched capacitors and Reactors etc.), as well as harmonic currents associated with the most onerous operating conditions of STATCOM Station, without loss of life.

The coupling transformer shall be designed in accordance with the most up-to-date experience in STATCOM application and shall incorporate the latest improvements of design currently employed in the industry. The Comprehensive design review of the Coupling Transformer of STATCOM Station shall be carried out by the TSP.

C.8.9.1 General Requirements

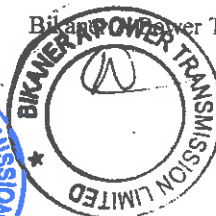
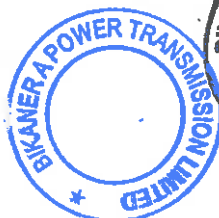

The coupling transformer shall be designed electrically and mechanically for operating conditions peculiar to STATCOM Station operation, which shall include, but not be limited to the following:

- a) Electrical insulation problems resulting from the transformer being subjected to voltages of distorted sinusoidal wave shape because of saturation, harmonics, trapped charges in capacitors etc.
- b) The cumulative effect of electro-dynamic forces produced during valve commutation or other short circuit conditions imposed by valve design limitation and valve group operation.
- c) Harmonic currents due to STATCOM operation, with reference to additional stray losses resulting from these harmonic currents.
- d) No generation of uncharacteristic harmonics by the transformers.
- e) Stresses due to normal control operation and other onerous operations such as blocking and de-blocking.
- f) Stress due to the fast response requirement of STATCOM for loading from 100% inductive to 100% capacitive and vice-versa.
- g) Overvoltage stresses for which STATCOM shall be designed as per specification would apply to the transformer also.
- h) All other stresses for which STATCOM Station shall be designed as per specification would apply to the transformer also.
- i) The transformer and all its accessories like Bushings, CTs etc shall be designed to withstand without damage, the thermal and mechanical effects of any external short circuit to earth and of a short circuit across the terminals of any winding for a period of 3 seconds. The short circuit level of the 400 kV system to which the transformer shall be connected, will be as per the maximum short circuit level of the main substation. Short Circuit level of the Coupling Transformer shall be as per the Short Circuit level of the respective Substation. Short circuit level for HV bushing shall be 63 kA for 1 Sec.
- j) The transformer shall be capable of being loaded in accordance with IEC 60076 or the overload conditions as specified whichever is the worst. There shall be no limitation imposed by bushings during its terminal fault.
- k) The transformer shall be capable of withstanding the mechanical stresses caused by symmetrical or asymmetrical faults on any winding.
- l) The transformer should be designed to carry a certain level of direct current consistent with the STATCOM design. To ensure minimum harmonics generation, the saturation flux density of the transformer should be higher than the maximum flux density reached over the full steady state (continuous operating) range; this margin shall be at least 10%. This maximum flux density (over the full steady-state range) is obtained at the highest

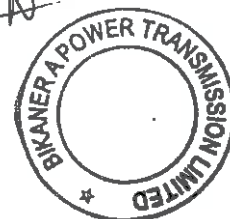
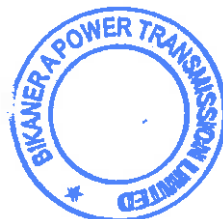
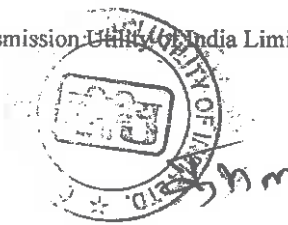

secondary voltage during any reactive power generation, highest reference voltage, minimum slope, and minimum continuous frequency. The flux density at the highest secondary voltage shall lie in the linear portion of the BH curve of the core. Any harmonic generated by the transformer should be considered for the design of the STATCOM.

- m) All protection class Current Transformers in the coupling transformer shall be of PX/PS type. Other details of these Current Transformers shall be as per protection/metering requirements and shall be decided during detailed engineering. However, the parameters of the Winding Temperature Indicator (WTI) of Current Transformer for each winding shall be as per the Coupling Transformer manufacturer.
- n) Transformers shall be capable of operating under natural cooled conditions up to the specified load. The forced cooling equipment shall come into operation by pre-set contacts of winding temperature indicator and the transformer shall operate as a forced cooling unit initially as Oil Natural Air Forced (ONAF) up to a specified load and then as Oil Forced Air Forced (OFAF). Cooling shall be so designed that during total failure of power supply to cooling fans and oil pumps, the transformer shall be able to operate at full load for at least ten (10) minutes without the calculated winding hot spot temperature exceeding 140 degree Celsius. Transformers fitted with two coolers, each capable of dissipating 50 percent of the heat due to losses at the continuous maximum rating, shall be capable of operating for 20 minutes in the event of failure of the oil circulating pump or blowers associated with one cooler without the calculated winding hot spot temperature exceeding 140 degree Celsius at continuous maximum rating.
- o) The transformer shall be free from any electrostatic charging tendency (ECT) under all operating conditions when all oil circulation systems are in operation. In general, the oil flow speed shall not exceed 1.0 m/sec within winding in the oil flow system of the transformers. The manufacturer shall ensure that there is no electrostatic charging tendency in the design.

The Technical Parameters of the Transformer shall be as below

Sl. No.	Description	Unit	Technical Parameters
1.1	Rated Capacity		
	HV	MVA	To meet the performance requirement and ratings of
	MV	MVA	

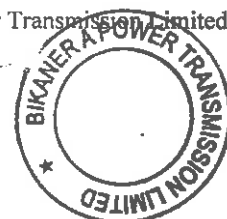
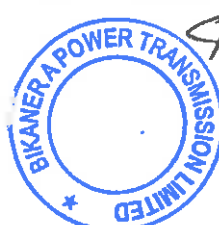

Sl. No.	Description	Unit	Technical Parameters
			STATCOM. The transformer shall be suitable for 100% reactive loading
1.2	Voltage ratio (Line to Line)		400 / XX (*)
1.3	Single / Three Phase Design		Single phase
1.4	Applicable Standard		IEC 60076
1.5	Rated Frequency	Hz	50
1.6	Cooling and Percentage Rating at different coolings		ONAN/ONAF/(OFAF or ODAF): 60% / 80%/100% OR ONAN/ONAF1/ONAF2: 60% /80%/100% OR OFAF (with 5 x 25% unit cooler if required)
1.7	Impedance at 75 °C (in percentage)		
	HV-MV		To suit the design requirements.
1.8	Tolerance on Impedance (HV-MV)	%	As per IEC
1.9	Service		Outdoor
1.10	Duty		Continuous Reactive loading
1.11	Overload Capacity		IEC-60076-7

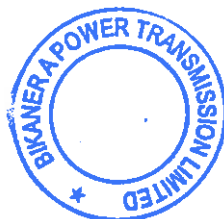
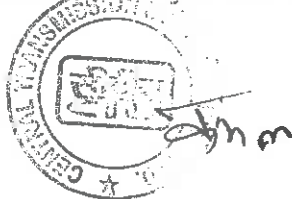
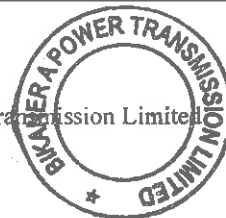

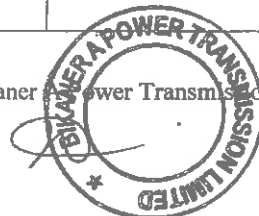
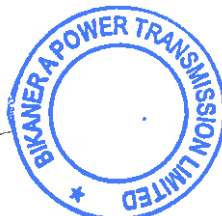

Sl. No.	Description	Unit	Technical Parameters
1.12	Temperature rise over 50 °C ambient Temp		
i)	Top oil measured by thermometer	°C	50
ii)	Average winding measured by resistance Method	°C	55
1.13	Windings		
i)	System Fault level		
	HV	kA	63
	MV	kA	To suit the design requirements.
ii)	Lightning Impulse withstand Voltage		
	HV	kVp	1300
	MV	kVp	*
	Neutral	kVp	170
iii)	Switching Impulse withstand Voltage		
	HV	kVp	1050
iv)	One Minute Power Frequency withstand Voltage		
	HV	kVrms	570
	MV	kVrms	*
	Neutral	kVrms	70

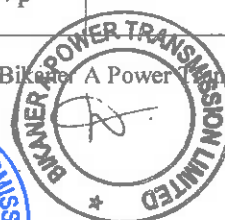
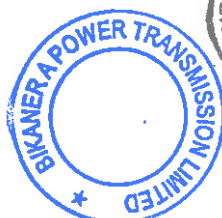
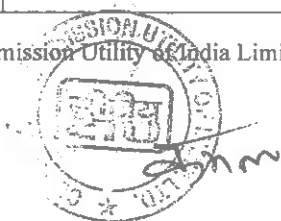

233

Sl. No.	Description	Unit	Technical Parameters
v)	Neutral Grounding		Solidly grounded
vi)	Insulation		
	HV		Graded
	MV		Uniform
vii)	Tan delta of winding	%	< 0.5
1.14	Vector Group (3 – ph) (unless specified differently elsewhere)		YNd*
1.15	Tap Changer		Not Applicable
1.16	Bushing		
i)	Rated voltage		
	HV	kV	420
	MV	kV	*
	Neutral	kV	36
ii)	Rated current (Min.)		
	HV	A	*
	MV	A	*
	Neutral	A	*
iii)	Lightning Impulse withstand Voltage		
	HV	kVp	1425
	MV	kVp	*



Sl. No.	Description	Unit	Technical Parameters
	Neutral	kVp	170
iv)	Switching Impulse withstand Voltage		
	HV	kVp	1050
v)	One Minute Power Frequency withstand Voltage		
	HV	kVrms	695
	MV	kVrms	*
	Neutral	kVrms	77
vi)	Minimum total creepage distances		
	HV	mm/kV	31
	MV	mm/kV	31
	Neutral	mm/kV	31
vii)	Tan delta of bushings		
	HV	%	Refer Note 2
	MV	%	Refer Note 2
viii)	Max Partial discharge level at Um		
	HV	pC	10
	MV	pC	10

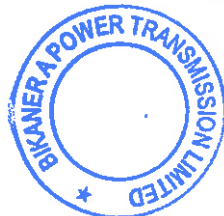

285

Sl. No.	Description	Unit	Technical Parameters
	Neutral		-
1.17	Max Partial discharge level at $1.58 * U_r / \sqrt{3}$	pC	100
1.18	Max Noise level at rated voltage and at principal tap at no load and all cooling Active	dB	80
1.19	Maximum Permissible Losses of		
	Transformers		
i)	Max. No Load Loss at rated voltage and Frequency	kW	To suit the design requirements.
ii)	Max. Load Loss at maximum continuous current and at 75 ^o C	kW	To suit the design requirements.
iii)	Max. Auxiliary Loss at rated voltage and Frequency	kW	To suit the design requirements.

Notes:

1. No external or internal Transformers / Reactors are to be used to achieve the specified HV/MV impedances.
2. The criteria for Transformer losses shall be "Copper Loss (Load Loss) > Iron Loss (No Load Loss) > Cooler Loss (Auxiliary Loss)".
3. (*) marked parameters shall be decided based on STATCOM manufacturer's requirement.

C.8.10 STATCOM Station MV Switchgear

The MV Switchgear shall be designed with the aim to achieve operation according to the overall performance requirements of the STATCOM Station.

C.8.10.1 MV Circuit Breaker

Central Transmission Utility of India Limited

171

Bikaner A Power Transmission Limited

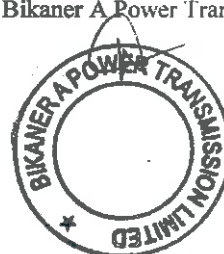
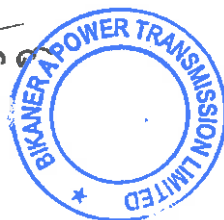
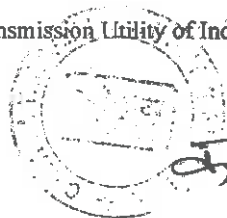

236

The MV Circuit Breaker shall comply with the relevant IEC standard and all other relevant Standards, and as specified in this specification. They shall satisfy the General Technical Requirements and shall be designed to operate in the environmental conditions specified in this specification.

The Circuit Breaker offered should be of SF6 type/Vacuum type only and of class C2, M2 as per IEC.

- i) The circuit breaker shall be complete with terminal connectors, operating mechanism, control cabinets, piping, interpole cable, cable accessories like glands, terminal blocks, marking ferrules, lugs, pressure gauges, density monitors (with graduated scale), galvanised support structure for CB and control cabinets, their foundation bolts and all other circuit breaker accessories required for carrying out all the functions the CB is required to perform.
- ii) All necessary parts to provide a complete and operable circuit breaker installation such as main equipment, terminals, control parts, connectors and other devices whether specifically called for herein or not shall be provided.
- iii) The support structure of the circuit breaker shall be hot dip galvanized. Exposed hardware items shall be hot dip galvanized or Electro-galvanized.
- iv) MV Circuit Breaker shall be equipped with controlled switching with consequent optimization of switching behavior, when used in:
 - Switching of Capacitor Bank
 - Switching of shunt Reactor Bank
- v) Reactor Switching Duty test shall be conducted on MV Circuit Breaker in line with latest edition of IEC 62271-110.
- vi) Type Tested for Back-to-Back Capacitor Bank Switching as per latest edition of IEC 62271-100.
- vii) Routine tests as per IEC: 62271-100 shall be performed on all circuit breakers.
- viii) The medium voltage circuit breakers in any of the branches shall be designed to switch off metallic three phase short circuits only limited by the transformer impedance of the STATCOM System (Coupling transformer) with the initial short circuit current and DC component according to IEC 60909-0. Thereby the worst case time constant where the maximum short circuit peak and DC component occur shall be considered. The network shall be considered to deliver the maximum short circuit power of the substation.

C.8.10.2 MV Isolator and Earth Switch

The isolators and earth switches shall comply with the IEC and all other relevant Standards, and as specified in this specification. They shall satisfy the General Technical Requirements and shall be designed to operate in the environmental conditions specified in this specification.

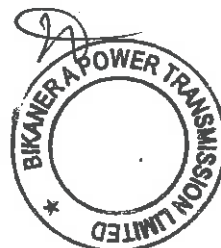
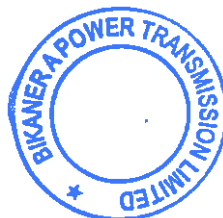
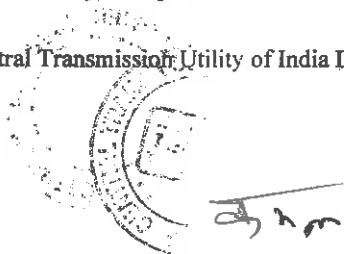

237

- i) The isolators and accessories shall conform in general to IEC-62271 series as per relevance (or IS:9921) except to the extent explicitly modified in specification.
- ii) Earth switches shall be provided on isolators wherever called for.
- iii) Switches shall be motor operated with local and remote operation features and local manual operation features. Remote operation of Earth Switch is not required.
- iv) Disconnections and earth switches shall electrically and mechanically be interlocked. Castle Key interlocking facilities shall be provided to mechanically interlock the earth switch and Isolator to the doors of valve rooms.

C.8.10.3 Instrument Transformers for STATCOM Station

The instrument transformers shall comply with the relevant IEC Standards. They shall satisfy the general Technical Requirement specified in the specification and shall be designed to operate in the environmental conditions specified in this Specification. The instrument transformers provided for control, metering and protective relaying functions shall have voltage and current ratings, accuracy ratings and burden capabilities adequate to provide their designated functions within the overall accuracy requirement of the systems.

Voltage Transformers

Voltage transformers shall comply with the relevant IEC standards IEC 61869 (Part-1, Part-3 and Part-5).

Current Transformers

Current transformers shall comply with IEC 61869 (Part-1 and Part-2). Type tests and routine tests as per relevant IEC.

C.8.10.4 Surge Arrester

TSP shall install the surge arresters necessary for the protection of the equipment associated with the STATCOM Station in accordance with the requirements as per the insulation coordination study. The surge arresters shall give consistent protection to their associated equipment against overvoltage produced by lightning or switching surges, internal or external station faults, and other system disturbances.

The surge arresters shall be rated such that they are able to discharge a specified maximum energy due to the application of lightning, switching surges, temporary over voltages and faults as determined by insulation coordination studies, without coming into the temperature region where thermal runaway could result upon subsequent application of maximum transient and steady state voltage conditions.

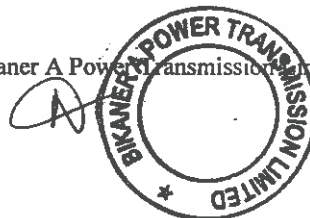
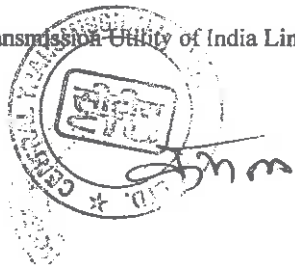

The arrester housing shall be porcelain/composite type. The end fittings shall be made of non-magnetic and corrosion proof material.

Internal components shall be designed to eliminate internal corona and also to ensure minimal capacitive coupling with any conducting layer of pollutant on the outside of the porcelain housing. Particular attention shall be given to the high discharge currents which some of the arresters may experience in service due to discharge of stored energy of the AC filter and reactive compensating equipment, tripping of STATCOM etc.

C.8.11 STATCOM Station Auxiliary Power Supply

The auxiliary supply of STATCOM Station shall conform with the system requirements relating to reliability, availability, and redundancy, performing continuously to help ensure that the complete STATCOM Station operates as per the requirements. STATCOM station Auxiliary supply including all necessary switchgear (viz. AC/DC, lighting boards etc.) shall be completely separate from the main 765/400/220 kV substation auxiliary supply, all loads of STATCOM station shall be fed from this supply. The auxiliary supply provides power to the controllers, cooling system, station supplies, and various other essential and non-essential loads. With the exception of the cooling system, all other essential loads are also connected to the DC system of the STATCOM Station which is also to be provided separately from the DC system of the main 765/400/220 kV substation.

The auxiliary supply system shall be able to provide a stable supply for the STATCOM Station during system faults such as single-phase faults, phase-to-phase faults, and three-phase faults and LVRT (Low Voltage Ride Through) to allow continuous operation of the STATCOM Station during these transient events.

The auxiliary supply system of each STATCOM Station shall consist of two main incomers and one emergency incomer from DG set. The two main incomers shall be required to be paired to act redundantly to help ensure a certain degree of reliability and availability. One of the main incomers shall be supplied from 33 kV tertiary winding of 765/400/33 kV or 400/220/33 kV ICT at the main substation.

The other main incomer can be supplied from any one of the following three options:

- Supplied from Tertiary/Yoke winding of STATCOM coupling Transformer.
- Supplied from MV Bus Bar of STATCOM Station.
- Supplied from Power PT on HV side of coupling Transformer.

Wherever the Voltage variation on the incomer is very high, a solid state AVR (Automatic Voltage Regulator) shall be provided to control the auxiliary supply voltage.

All MV incomers shall be provided with suitable CB, disconnector, instrument Transformer etc along with necessary protection system.

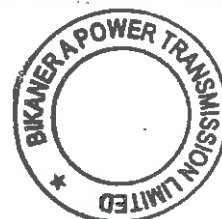
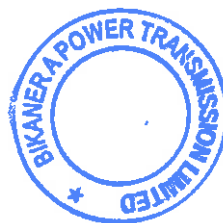
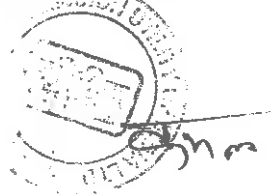

C.8.12 Fire Protection System for STATCOM Station:

Necessary fire protection for STATCOM units. Coupling Transformer, MSC, MCR and Harmonic filter (if any) shall be required. The main features of these protections are as under.

Fire Detection and Alarm System:

Suitable fire detection system using smoke detectors and/or heat detectors shall be provided in STATCOM Station for all room and areas. These smoke fire detection systems shall be connected to a separate Fire annunciation system clearly identifying the zone.

Hydrant System:

The hydrant system shall be extended from fire fighting system of the substation in the yard. Suitable number of hydrants shall be provided for protection of STATCOM Station equipment in the yard namely Coupling Transformer, MSCs, MSRs and Harmonic Filter (if required) etc as applicable for the station. Further suitable number of hydrants shall also be provided for STATCOM Station building

HVW System:

HVW (High Velocity Water) Spray system shall be provided for coupling transformer. The tapping for HVW system shall be done from nearby transformer/Reactor or any other suitable point of the main substation fire-fighting line-

Fire protection system shall be provided in accordance with the Central Electricity Authority (Measures relating to Safety and Electric Supply) Regulations, 2023.

C.8.13 Air-conditioning and ventilation system for STATCOM station

The STATCOM Station shall be provided with Air conditioning system as per requirement.

1) AC System (Except Valve Hall):

Air condition system shall be provided for the following rooms in the STATCOM Building:

- a. Control and Relay room
- b. Battery room
- c. Conference Room
- d. Store cum workshop
- e. Cooling system room
- f. Lobby



Capacity and quantity of the AC units shall be decided based on heat load calculation and redundancy requirement.

2) Air-Conditioning System for Valve hall:

Air-Conditioning shall be provided for each Valve room for maintaining the following inside conditions round the year:

DBT - 35 °C (Maximum) Relative Humidity (RH) - 60% (Maximum)

The system shall be designed for an outside ambient temperature of 50 °C. Based on the above system design and parameters for valve room the AC system shall comprise "AHU and Air-cooled DX Condensing units" with one Main and one Standby unit for each room. The system shall be designed for 24 Hours, 365 Days of the year operation to maintain the inside temperatures of the Valve Hall for proper operation of the critical equipment. The air-cooled condensing unit shall be designed for continuous duty.

C.9 Engineering studies

The TSP shall carry out studies as brought out in this section with a model of the STATCOM in PSSE and PSCAD and documentation of the same shall be preserved and to be submitted to CEA/CTU, as per their requirement. The objective of these studies is to verify the steady state requirement of reactive power under normal and contingency operating conditions for peak and light loads conditions in the network.

The studies shall have to be carried out for

- Peak Load
- Light Load
- Contingency Conditions

The load flow and dynamic file available with CTU shall be provided to the TSP in PSSE version 34 format. If data is not available typical data shall be assumed by TSP.

The studies should demonstrate that the STATCOM system meets all system and equipment specified performance criteria as per the specification. Engineering studies should include, but not be limited to, the studies described in subsequent subsections.

C.9.1 System dynamic performance studies

Dynamic performance studies should verify that the STATCOM system controls the system's dynamic performance during system disturbances. Dynamic performance studies include the following:

- a. Studies verifying that the STATCOM provides adequate dynamic control to meet the system and STATCOM system performance criteria for the system conditions.

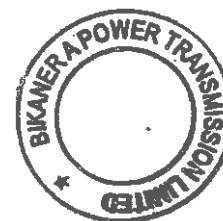
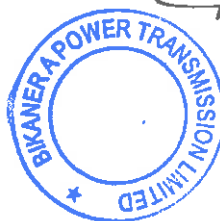

- b. Study of response time and of the STATCOM system's behavior and contribution to the system's recovery from faults.
- c. Studies to verify the operation of any supplementary controls designed to damp power oscillations following system disturbances.
- d. Studies to evaluate the interaction of the STATCOM controls with the other nearby control systems, including high-voltage direct current (HVDC) controls, generator controls, and controls of other flexible AC transmission systems (FACTS) devices

In addition to the above, relevant studies shall include the cases stated as mentioned in Annexure-I

C.9.2 Harmonic performance

The studies should evaluate resultant maximum harmonic levels at the STATCOM system point of common coupling (PCC), and determine maximum stresses on all STATCOM system components. The study report should include the following:

- a. Evaluation of specified system and operating conditions (refer to Clause 5) under all possible STATCOM operating conditions.
- b. Evaluation within maximum ranges of STATCOM system component tolerances (worst performance values may not occur at detuning extremes).
- c. Evaluation with maximum system voltage unbalance (refers to item 8 and item 9 in Table 3 of Clause 5).
- d. Evaluation of the worst case resonance condition between STATCOM system and overall system.
- e. Evaluation of possible resonant over voltages.
- f. Transformer saturation induced harmonics for component rating calculation only.
- g. Evaluation of impact considering single phase auto reclose deadtime.

C.9.3 Electromagnetic transients, control performance, and overvoltage studies

Transient overvoltage studies should be performed with the actual control modeled to verify that the STATCOM system equipment is adequately protected against over voltages and over currents (including excessive valve recovery voltages) from power system transients resulting from switching, fault clearing events, and credible STATCOM system maloperations. Evaluation shall include the following:

- a. Study of start-up, including transformer energization, shutdown, switching coordination, and other local area network switching events
- b. Study of STATCOM system protection and protection coordination
- c. Faults on the high-voltage (HV) and MV bus (single line-to-ground, phase-to-phase, and three-phase)

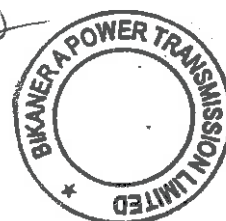
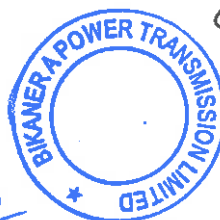
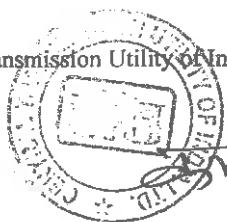

- d. Faults across the VSC, capacitors, and other equipment if used.
- e. Control interaction

C.9.4 Insulation coordination study

Overall insulation coordination should be verified by considering the results of 8.4 (dynamic over voltages, and fault and switching transients), including the impacts of lightning surges on the STATCOM equipment. This study should determine and verify insulation levels, clearances, and arrester placement and ratings.

C.9.5 Other Studies

- a) Grounding Study
- b) Protection coordination
- c) PLC/radio interference
- d) Magnetic field strength
- e) Other studies as applicable

C.9.6 Software simulation models

The TSP shall provide the latest following PSCAD and PSSE simulation model(s) and parameters to CEA/CTU/GRID-INDIA along with detailed documentation for the purpose of future simulation to adequately represent and model the proposed STATCOM system in the respective software:

- a. **Stability model.** TSP should provide a detailed STATCOM system dynamics model for use in (PSCAD and PSSE) power flow and stability simulation software, the model detail should be appropriate and complete for positive-sequence power system simulation and analysis that is typically performed with power flow and transient stability programs. All appropriate control features for such analysis will be modeled, and necessary documentation on the theory and use of model should be provided. Further, a generic model, benchmarked to detailed STATCOM stability model, shall also be furnished for distribution.
- b. **Transient model.** TSP should provide a detailed STATCOM transients model for use in PSCAD. The model detail should be appropriate and complete for the transient response calculation of the STATCOM system. All appropriate control features for such analysis will be modelled, and necessary documentation on the theory and use of model should be provided. Further, a generic model, benchmarked to detailed STATCOM transient model, shall also be furnished for distribution.

PSS/E files may be used for developing RTDS files/ models. For simulation of STATCOM in PSS/E file (load flow and dynamic) and PSCAD (Transient) model for STATCOM is required for study. TSP will share STATCOM models with CEA, CTU



243

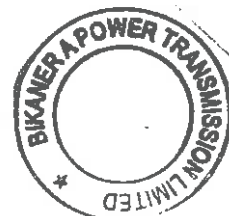
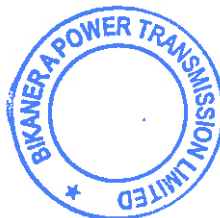

and Grid-India along with detailed documentation for above study purposes and simulations. For PSS/E, both Generic and User-defined models shall be shared by the TSP with the CEA, CTU and Grid-India. Generic model (PSS/E) response shall be benchmarked with user-defined model (PSS/E and PSCAD) to the extent possible by the TSP. Generic models can be shared by the CEA, CTU and Grid-India with the concerned stakeholders/external party(ies) e. g. STUs etc. on need basis. For User Defined model, confidentiality shall be maintained by the CEA, CTU and Grid-India. For PSCAD, User Defined model shall be provided by the TSP for which confidentiality shall be maintained by the CEA, CTU and Grid-India.

Both UDM (PSCAD and PSS/E) and Generic model (PSSE) shall be provided by OEMs to CEA/CTU/GRID-INDIA without any NDA (Non-Disclosure Agreement)

C.9.7 Factory tests of controls

The integrated nature of the performance of the STATCOM in an electrical grid requires the following tests:

- a. The TSP should perform factory simulator system tests for integrated control and protection system to ensure the proper operation of the same. The control system should be connected to a digital simulator with adequate representation of the electrical network for various conditions. The STATCOM system controller needs to be representative of control functions, including basic controllers but inclusive of supplementary controls, firing controls, and protective functions integrated into the controllers. TSP shall submit the FAT (Factory Acceptance Test) reports of STATCOM controls to CTU/RLDC.
- b. The simulator should provide an accurate network representation including network harmonic behavior, as well as synchronous condensers, power stations, generators (with AVRs), and pump storage schemes, existing HVDC, SVCs and STATCOMs, future SVCs and STATCOMs, FSC (fixed series capacitors), and shunt reactors/capacitors/filters.

STATCOM system control function type tests on a simulator should include the following:

- Verification of each control function.
- Verification of control linearity.
- Verification of control redundancy.
- Verification of the monitoring system.

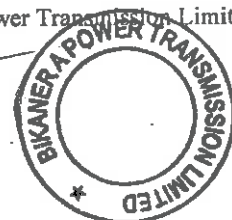
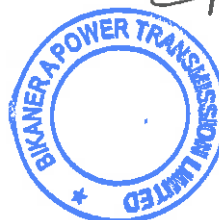

- Verification of the protection system with reference to integrated protective functions included in the Controllers and firing controllers.
- Verification of overall system performance for minor and major system disturbances.
- Verification of processor loading of all digital controllers.
- Verification of STATCOM system parallel operation with other controls in the system and control Stability.
- Verification of control equipment performance for auxiliary power supply voltage (AC and DC) and frequency variations (AC).
- Routine production tests of all control functions, and separately of all protection functions.

C.10.0 VISUAL MONITORING SYSTEM FOR WATCH AND WARD OF STATCOM STATION

Visual monitoring system (VMS) for effective watch and ward of STATCOM station premises covering the areas of entire switchyard, STATCOM building, Coupling Transformer, Cooling Towers and main gate, shall be provided. The TSP shall design, supply, erect, test and commission the complete system including cameras, Digital video recorder system, mounting arrangement for cameras, cables, LAN Switches, UPS and any other items/accessories required to complete the system.

Features of VMS system shall be as those specified for main substation. The number of cameras and their locations shall be decided in such a way that any location covered in the area can be scanned. The cameras shall be located in such a way to monitor at least:

- a) Coupling Transformer, Mechanically Switched Reactors (if any) and Mechanically Switched Capacitors (if any), AC filter banks (if any).
- b) STATCOM Valve Hall, Cooling System, Electrical and Mechanical Auxiliary area.
- c) Entrance to STATCOM Station.
- d) All other Major Equipment (such as CB, CT, VT, SA etc.)

The cameras can be mounted on structures, buildings or any other suitable mounting arrangement.

C.11.0 Spares, Special Tools and Tackles

Considering the STATCOM as high technology proprietary equipment of the OEM, the TSP shall ensure necessary spares are procured to maintain the necessary reliability and availability of STATCOM station. Further all necessary special tools and tackles required for erection, testing, commissioning, and maintenance of equipment shall also be taken.

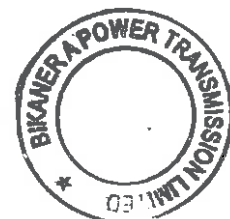
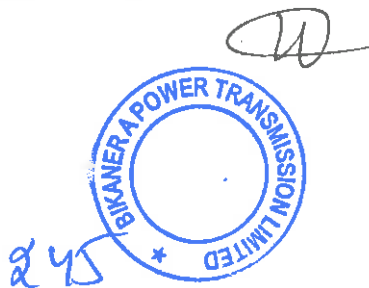
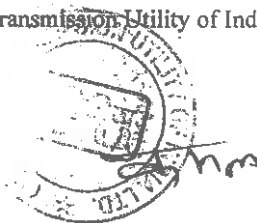

Annexure-I

Contingency Cases for Bikaner-IV STATCOM

A) N-1 Contingency

Contingency at 765 kV level

1. Three Phase Fault close to 765 kV bus of Bikaner-IV PS followed by tripping of one circuit of Bikaner-IV PS–Siwani 765 kV D/C line (1st) (fault persist for 100 ms)
2. Single Phase to Ground Fault close to 765 kV bus of Bikaner-IV PS followed by single pole opening (100 ms) of the faulted phase and unsuccessful re-closure (dead time 1 second) followed by 3-pole opening (100 ms) of the faulted line i.e. tripping of one circuit of Bikaner-IV PS–Siwani 765 kV D/C line (1st)
3. Three Phase Fault close to 765 kV bus of Siwani S/s followed by tripping of one circuit of Bikaner-IV PS–Siwani 765 kV D/C line (1st) (fault persist for 100 ms)
4. Single Phase to Ground Fault close to 765 kV bus of Siwani S/s followed by single pole opening (100 ms) of the faulted phase and unsuccessful re-closure (dead time 1 second) followed by 3-pole opening (100 ms) of the faulted line i.e. tripping of one circuit of Bikaner-IV PS–Siwani 765 kV D/C line (1st)
5. Three Phase Fault close to 765 kV bus of Bikaner-III PS followed by tripping of one circuit of Bikaner-III PS– Neemrana-II 765 kV D/C line (1st) (fault persist for 100 ms)
6. Single Phase to Ground Fault close to 765 kV bus of Bikaner-III PS followed by single pole opening (100 ms) of the faulted phase and unsuccessful re-closure (dead time 1 second) followed by 3-pole opening (100 ms) of the faulted line i.e. tripping of one circuit of Bikaner-III PS– Neemrana-II 765 kV D/c line (1st)
7. Three Phase Fault close to 765 kV bus of Neemrana-II S/s followed by tripping of one circuit of Bikaner-III PS– Neemrana-II 765 kV D/C line (1st) (fault persist for 100 ms)
8. Single Phase to Ground Fault close to 765 kV bus of Neemrana-II S/s followed by single pole opening (100 ms) of the faulted phase and unsuccessful re-closure (dead time 1 second) followed by 3-pole opening (100 ms) of the faulted line i.e. tripping of one circuit of Bikaner-III PS– Neemrana-II 765 kV D/C line (1st)

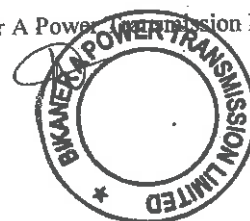
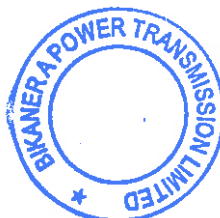
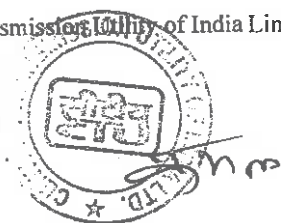

Contingency at 400 kV level

9. Three Phase Fault close to 400 kV bus of Bikaner-IV PS followed by tripping of one circuit of Bikaner-IV PS –Bikaner-III PS 400 kV D/C line (fault persist for 100 ms)
10. Single Phase to Ground Fault close to 400 kV bus of Bikaner-IV PS followed by single pole opening (100 ms) of the faulted phase and unsuccessful re-closure (dead time 1 second) followed by 3-pole opening (100 ms) of the faulted line i.e. tripping of one circuit of Bikaner-IV PS –Bikaner-III PS 400 kV D/C line
11. Three Phase Fault close to 400 kV bus of Bikaner-III PS followed by tripping of one circuit of Bikaner-IV PS –Bikaner-III PS 400 kV D/C line (fault persist for 100 ms)
12. Single Phase to Ground Fault close to 400 kV bus of Bikaner-III PS followed by single pole opening (100 ms) of the faulted phase and unsuccessful re-closure (dead time 1 second) followed by 3-pole opening (100 ms) of the faulted line i.e. tripping of one circuit of Bikaner-IV PS –Bikaner-III PS 400 kV D/C line
13. Three Phase Fault close to 400 kV bus of Bikaner-IV PS followed by tripping of one circuit of Bikaner-IV PS –Bikaner-II PS 400 kV D/C line (fault persist for 100 ms)
14. Single Phase to Ground Fault close to 400 kV bus of Bikaner-IV PS followed by single pole opening (100 ms) of the faulted phase and unsuccessful re-closure (dead time 1 second) followed by 3-pole opening (100 ms) of the faulted line i.e. tripping of one circuit of Bikaner-IV PS –Bikaner-II PS 400 kV D/C line
15. Three Phase Fault close to 400 kV bus of Bikaner-II PS followed by tripping of one circuit of Bikaner-IV PS –Bikaner-II PS 400 kV D/C line (fault persist for 100 ms)
16. Single Phase to Ground Fault close to 400 kV bus of Bikaner-II PS followed by single pole opening (100 ms) of the faulted phase and unsuccessful re-closure (dead time 1 second) followed by 3-pole opening (100 ms) of the faulted line i.e. tripping of one circuit of Bikaner-IV PS –Bikaner-II PS 400 kV D/C line
17. Three Phase Fault close to 400 kV bus of Siwani S/s followed by tripping of one circuit of Siwani –Jind(PG) 400 kV D/C line (fault persist for 100 ms)
18. Single Phase to Ground Fault close to 400 kV bus of Siwani S/s followed by single pole opening (100 ms) of the faulted phase and unsuccessful re-closure (dead time 1 second) followed by 3-pole opening (100 ms) of the faulted line i.e. tripping of one circuit of Siwani –Jind(PG) 400 kV D/C line

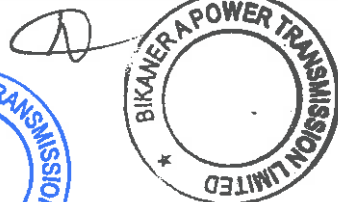
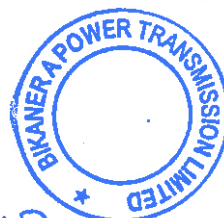

247

19. Three Phase Fault close to 400 kV bus of Jind (PG) S/s followed by tripping of one circuit of Siwani –Jind(PG) 400 kV D/C line (fault persist for 100 ms)
20. Single Phase to Ground Fault close to 400 kV bus of Jind (PG) S/s followed by single pole opening (100 ms) of the faulted phase and unsuccessful re-closure (dead time 1 second) followed by 3-pole opening (100 ms) of the faulted line i.e. tripping of one circuit of Siwani –Jind(PG) 400 kV D/C line
21. Three Phase Fault close to 400 kV bus of Siwani S/s followed by tripping of one circuit of Siwani –Patran (Indi Grid) 400 kV D/C line (fault persist for 100 ms)
22. Single Phase to Ground Fault close to 400 kV bus of Siwani S/s followed by single pole opening (100 ms) of the faulted phase and unsuccessful re-closure (dead time 1 second) followed by 3-pole opening (100 ms) of the faulted line i.e. tripping of one circuit of Siwani – Patran (Indi Grid) 400 kV D/C line
23. Three Phase Fault close to 400 kV bus of Patran (Indi Grid) S/s followed by tripping of one circuit of Siwani – Patran (Indi Grid) 400 kV D/C line (fault persist for 100 ms)
24. Single Phase to Ground Fault close to 400 kV bus of Patran (Indi Grid) S/s followed by single pole opening (100 ms) of the faulted phase and unsuccessful re-closure (dead time 1 second) followed by 3-pole opening (100 ms) of the faulted line i.e. tripping of one circuit of Siwani – Patran (Indi Grid) 400 kV D/C line
25. Three Phase Fault close to 400 kV bus of Siwani S/s followed by tripping of one circuit of Siwani –Sonipat(PG) 400 kV D/C line (fault persist for 100 ms)
26. Single Phase to Ground Fault close to 400 kV bus of Siwani S/s followed by single pole opening (100 ms) of the faulted phase and unsuccessful re-closure (dead time 1 second) followed by 3-pole opening (100 ms) of the faulted line i.e. tripping of one circuit of Siwani – Sonipat(PG) 400 kV D/C line
27. Three Phase Fault close to 400 kV bus of Sonipat(PG) S/s followed by tripping of one circuit of Siwani – Sonipat(PG) 400 kV D/C line (fault persist for 100 ms)
28. Single Phase to Ground Fault close to 400 kV bus of Sonipat(PG) S/s followed by single pole opening (100 ms) of the faulted phase and unsuccessful re-closure (dead time 1 second) followed by 3-pole opening (100 ms) of the faulted line i.e. tripping of one circuit of Siwani – Sonipat(PG) 400 kV D/C line
29. Three Phase Fault close to 400 kV bus of Siwani S/s followed by tripping of one circuit of Siwani –Fatehabad(PG) 400 kV D/C line (fault persist for 100 ms)
30. Single Phase to Ground Fault close to 400 kV bus of Siwani S/s followed by single pole opening (100 ms) of the faulted phase and unsuccessful re-closure (dead time 1 second) followed by 3-pole opening (100 ms) of the faulted line i.e. tripping of one circuit of Siwani – Fatehabad(PG) 400 kV D/C line

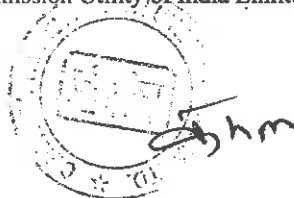

248

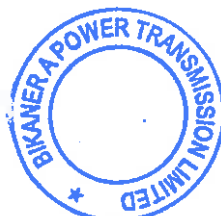

31. Three Phase Fault close to 400 kV bus of Fatehabad(PG) S/s followed by tripping of one circuit of Siwani – Fatehabad(PG) 400 kV D/C line (fault persist for 100 ms)
32. Single Phase to Ground Fault close to 400 kV bus of Fatehabad(PG) S/s followed by single pole opening (100 ms) of the faulted phase and unsuccessful re-closure (dead time 1 second) followed by 3-pole opening (100 ms) of the faulted line i.e. tripping of one circuit of Siwani – Fatehabad(PG) 400 kV D/C line
33. Three Phase Fault close to 400 kV bus of Bikaner-II PS followed by tripping of one circuit of Bikaner-II PS –Khetri 400 kV 2xD/C line (fault persist for 100 ms)
34. Single Phase to Ground Fault close to 400 kV bus of Bikaner-II PS followed by single pole opening (100 ms) of the faulted phase and unsuccessful re-closure (dead time 1 second) followed by 3-pole opening (100 ms) of the faulted line i.e. tripping of one circuit of Bikaner-II PS – Khetri 400 kV 2xD/C line
35. Three Phase Fault close to 400 kV bus of Khetri S/s followed by tripping of one circuit of Bikaner-II PS – Khetri 400 kV 2xD/C line (fault persist for 100 ms)
36. Single Phase to Ground Fault close to 400 kV bus of Khetri S/s followed by single pole opening (100 ms) of the faulted phase and unsuccessful re-closure (dead time 1 second) followed by 3-pole opening (100 ms) of the faulted line i.e. tripping of one circuit of Bikaner-II PS – Khetri 400 kV 2xD/C line
37. Three Phase Fault close to 400 kV bus of Bikaner-III PS followed by tripping of one circuit of Bikaner-III PS –Bikaner-II 400 kV D/C line (fault persist for 100 ms)
38. Single Phase to Ground Fault close to 400 kV bus of Bikaner-III PS followed by single pole opening (100 ms) of the faulted phase and unsuccessful re-closure (dead time 1 second) followed by 3-pole opening (100 ms) of the faulted line i.e. tripping of one circuit of Bikaner-III PS –Bikaner-II 400 kV D/C line
39. Three Phase Fault close to 400 kV bus of Bikaner-II PS followed by tripping of one circuit of Bikaner-III PS –Bikaner-II 400 kV D/C line (fault persist for 100 ms)
40. Single Phase to Ground Fault close to 400 kV bus of Bikaner-II PS followed by single pole opening (100 ms) of the faulted phase and unsuccessful re-closure (dead time 1 second) followed by 3-pole opening (100 ms) of the faulted line i.e. tripping of one circuit of Bikaner-III PS –Bikaner-II 400 kV D/C line
41. Three Phase Fault close to 400 kV bus of Bikaner-III PS followed by tripping of one circuit of Bikaner-III PS –Bikaner(PG) 400 kV D/C line (fault persist for 100 ms)

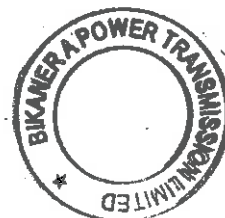
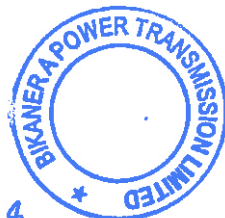
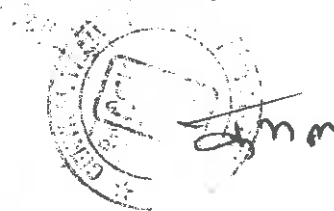

42. Single Phase to Ground Fault close to 400 kV bus of Bikaner-III PS followed by single pole opening (100 ms) of the faulted phase and unsuccessful re-closure (dead time 1 second) followed by 3-pole opening (100 ms) of the faulted line i.e. tripping of one circuit of Bikaner-III PS –Bikaner (PG) 400 kV D/C line
43. Three Phase Fault close to 400 kV bus of Bikaner (PG) followed by tripping of one circuit of Bikaner-III PS –Bikaner (PG) 400 kV D/C line (fault persist for 100 ms)
44. Single Phase to Ground Fault close to 400 kV bus of Bikaner (PG) followed by single pole opening (100 ms) of the faulted phase and unsuccessful re-closure (dead time 1 second) followed by 3-pole opening (100 ms) of the faulted line i.e. tripping of one circuit of Bikaner-III PS –Bikaner (PG) 400 kV D/C line

Contingency at 220 kV level

45. Three phase fault close to 220 kV Bikaner-IV PS bus with Tripping of 300 MW generation at 220 kV Bikaner-IV PS bus
46. Three phase fault close to 400 kV Bikaner-IV PS bus, with Tripping of 900 MW generation at 400 kV Bikaner-IV PS bus
47. Three phase fault close to 220 kV Bikaner-III PS bus with Tripping of 300 MW generation at 220 kV Bikaner-III PS bus
48. Three phase fault close to 400 kV Bikaner-III PS bus, with Tripping of 1000 MW generation at 400 kV Bikaner-III PS bus
49. Three phase fault close to 220 kV Bikaner-II PS bus, with Tripping of 400 MW generation at 220 kV Bikaner-II PS bus
50. Three phase fault close to 400 kV Bikaner-II PS bus, with Tripping of 1000 MW generation at 220 kV Bikaner-II PS bus

B) N-1-1 Contingency

Contingency at 765 kV level

1. Case 1 + Single Phase Fault close to 765 kV bus of Bikaner-IV PS followed by single pole opening (100 ms) of the faulted phase and successful re-closure (dead time 1 second) of Bikaner-IV – Siwani 2nd ckt.
2. Case 3 + Single Phase Fault close to 765 kV bus of Siwani S/s followed by single pole opening (100 ms) of the faulted phase and successful re-closure (dead time 1 second) of Bikaner-IV – Siwani 2nd ckt.

Central Transmission Utility of India Limited

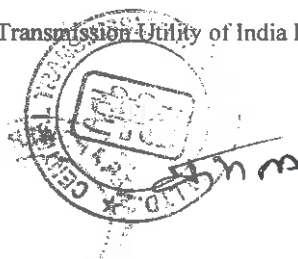

185

Bikaner A Power Transmission Limited

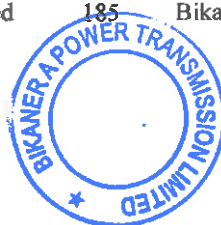

JA

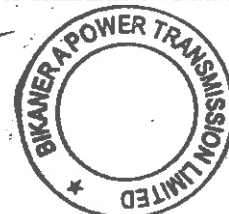

250

3. Case 5 + Single Phase Fault close to 765 kV bus of Bikaner-III PS followed by single pole opening (100 ms) of the faulted phase and successful re-closure (dead time 1 second) of Bikaner-III – Neemrana 2nd ckt.
4. Case 7 + Single Phase Fault close to 765 kV bus of Neemrana-II S/s followed by single pole opening (100 ms) of the faulted phase and successful re-closure (dead time 1 second) of Bikaner-III – Neemrana 2nd ckt.
5. Case 1 + Single Phase Fault close to 400 kV bus of Bikaner-IV PS followed by single pole opening (100 ms) of the faulted phase and unsuccessful re-closure (dead time 1 second) followed by 3-pole opening (100 ms) of the faulted line i.e. one circuit of Bikaner-IV PS –Bikaner-III PS 400 kV D/C line
6. Case 1 + Single Phase Fault close to 400 kV bus of Bikaner-IV PS followed by single pole opening (100 ms) of the faulted phase and unsuccessful re-closure (dead time 1 second) followed by 3-pole opening (100 ms) of the faulted line i.e. one circuit of Bikaner-IV PS –Bikaner-II PS 400 kV D/C line

Contingency at 400 kV level

7. Case 9+ Single Phase Fault close to 400 kV bus of Bikaner-IV PS followed by single pole opening (100 ms) of the faulted phase and unsuccessful re-closure (dead time 1 second) followed by 3-pole opening (100 ms) of the faulted line i.e. 2nd circuit of Bikaner-IV PS –Bikaner-III PS 400 kV D/C line
8. Case 11+ Single Phase Fault close to 400 kV bus of Bikaner-III PS followed by single pole opening (100 ms) of the faulted phase and unsuccessful re-closure (dead time 1 second) followed by 3-pole opening (100 ms) of the faulted line i.e. 2nd circuit of Bikaner-IV PS –Bikaner-III PS 400 kV D/C line
9. Case 13+ Single Phase Fault close to 400 kV bus of Bikaner-IV PS followed by single pole opening (100 ms) of the faulted phase and unsuccessful re-closure (dead time 1 second) followed by 3-pole opening (100 ms) of the faulted line i.e. 2nd circuit of Bikaner-IV PS –Bikaner-II PS 400 kV D/C line
10. Case 15 + Single Phase Fault close to 400 kV bus of Bikaner-II PS followed by single pole opening (100 ms) of the faulted phase and unsuccessful re-closure (dead time 1 second) followed by 3-pole opening (100 ms) of the faulted line i.e. 2nd circuit of Bikaner-IV PS –Bikaner-II PS 400 kV D/C line
11. Case 17 + Single Phase Fault close to 400 kV bus of Siwani S/s followed by single pole opening (100 ms) of the faulted phase and unsuccessful re-closure (dead time 1 second) followed by 3-pole opening (100 ms) of the faulted line i.e. 2nd circuit of Siwani –Jind(PG) 400 kV D/C line

Central Transmission Utility of India Limited

Bikaner A Power Transmission Limited

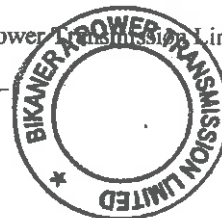
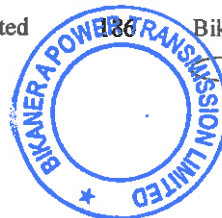

251

12. Case 19 + Single Phase Fault close to 400 kV bus of Jind(PG) S/s followed by single pole opening (100 ms) of the faulted phase and unsuccessful re-closure (dead time 1 second) followed by 3-pole opening (100 ms) of the faulted line i.e. 2nd circuit of Siwani –Jind(PG) 400 kV D/C line
13. Case 21 + Single Phase Fault close to 400 kV bus of Siwani S/s followed by single pole opening (100 ms) of the faulted phase and unsuccessful re-closure (dead time 1 second) followed by 3-pole opening (100 ms) of the faulted line i.e. 2nd circuit of Siwani –Patran(Indi Grid) 400 kV D/C line
14. Case 23 + Single Phase Fault close to 400 kV bus of Patran(Indi Grid) S/s followed by single pole opening (100 ms) of the faulted phase and unsuccessful re-closure (dead time 1 second) followed by 3-pole opening (100 ms) of the faulted line i.e. 2nd circuit of Siwani – Patran(Indi Grid) 400 kV D/C line
15. Case 25 + Single Phase Fault close to 400 kV bus of Siwani S/s followed by single pole opening (100 ms) of the faulted phase and unsuccessful re-closure (dead time 1 second) followed by 3-pole opening (100 ms) of the faulted line i.e. 2nd circuit of Siwani –Sonipat(PG) 400 kV D/C line
16. Case 27 + Single Phase Fault close to 400 kV bus of Sonipat(PG) S/s followed by single pole opening (100 ms) of the faulted phase and unsuccessful re-closure (dead time 1 second) followed by 3-pole opening (100 ms) of the faulted line i.e. 2nd circuit of Siwani – Sonipat(PG) 400 kV D/C line
17. Case 29 + Single Phase Fault close to 400 kV bus of Siwani S/s followed by single pole opening (100 ms) of the faulted phase and unsuccessful re-closure (dead time 1 second) followed by 3-pole opening (100 ms) of the faulted line i.e. 2nd circuit of Siwani –Fatehabad (PG) 400 kV D/C line
18. Case 31 + Single Phase Fault close to 400 kV bus of Fatehabad (PG) S/s followed by single pole opening (100 ms) of the faulted phase and unsuccessful re-closure (dead time 1 second) followed by 3-pole opening (100 ms) of the faulted line i.e. 2nd circuit of Siwani – Fatehabad(PG) 400 kV D/C line
19. Case 33 + Single Phase Fault close to 400 kV bus of Bikaner-II PS followed by single pole opening (100 ms) of the faulted phase and unsuccessful re-closure (dead time 1 second) followed by 3-pole opening (100 ms) of the faulted line i.e. 2nd circuit of Bikaner-II PS – Khetri 400 kV 2xD/C line
20. Case 35 + Single Phase Fault close to 400 kV bus of Khetri S/s followed by single pole opening (100 ms) of the faulted phase and unsuccessful re-closure (dead time 1 second) followed by 3-pole opening (100 ms) of the faulted line i.e. 2nd circuit of Bikaner-II PS – Khetri 400 kV 2xD/C line
21. Case 37 + Single Phase Fault close to 400 kV bus of Bikaner-III PS followed by single pole opening (100 ms) of the faulted phase and unsuccessful re-closure

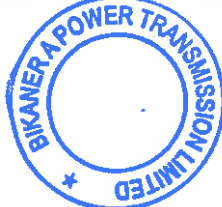

- (dead time 1 second) followed by 3-pole opening (100 ms) of the faulted line i.e. 2nd circuit of Bikaner-III PS –Bikaner-II 400 kV D/C line
22. Case 39 + Single Phase Fault close to 400 kV bus of Bikaner-II PS followed by single pole opening (100 ms) of the faulted phase and unsuccessful re-closure (dead time 1 second) followed by 3-pole opening (100 ms) of the faulted line i.e. 2nd circuit of Bikaner-III PS –Bikaner-II 400 kV D/C line
 23. Case 41 + Single Phase Fault close to 400 kV bus of Bikaner-III PS followed by single pole opening (100 ms) of the faulted phase and unsuccessful re-closure (dead time 1 second) followed by 3-pole opening (100 ms) of the faulted line i.e. 2nd circuit of Bikaner-III PS –Bikaner(PG) 400 kV D/C line
 24. Case 43 + Single Phase Fault close to 400 kV bus of Bikaner (PG) followed by single pole opening (100 ms) of the faulted phase and unsuccessful re-closure (dead time 1 second) followed by 3-pole opening (100 ms) of the faulted line i.e. 2nd circuit of Bikaner-III PS –Bikaner(PG) 400 kV D/C line
 25. Case 9+ Single Phase Fault close to 765 kV bus of Bikaner-IV PS followed by single pole opening (100 ms) of the faulted phase and successful re-closure (dead time 1 second) of Bikaner-IV – Siwani one ckt (out of four ckts)
 26. Case 13+ Single Phase Fault close to 765 kV bus of Bikaner-IV PS followed by single pole opening (100 ms) of the faulted phase and successful re-closure (dead time 1 second) of Bikaner-IV – Siwani one ckt (out of four ckts)

STATCOM Station shall be capable of ride through for multiple voltage dips within pre-defined time window as per following curve:

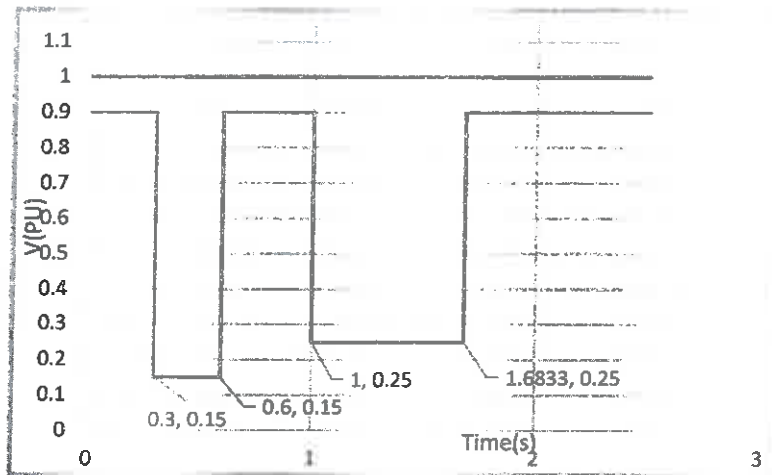

Note:

1. In the 'N-1-1' as stated above, if there is a temporary fault, the system shall not lose the second element after clearing of fault but shall successfully survive the disturbance.

Central Transmission Utility of India Limited 188 Bikaner A Power Transmission Limited

In case of permanent fault, the system shall lose the second element as a result of fault clearing and thereafter, shall asymptotically reach to a new steady state without losing synchronism. In this new state, the system parameters (i.e. voltages and line loadings) shall not exceed emergency limits, however, there may be requirement of load shedding rescheduling of generation so as to bring system parameters within normal limits

Central Transmission Utility of India Limited

189

Bikaner A Power Transmission Limited

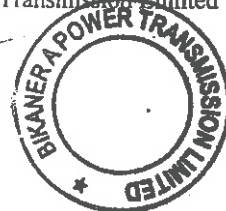
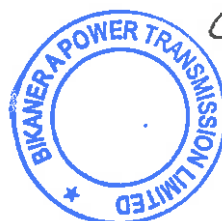

254

SPECIFIC TECHNICAL REQUIREMENTS FOR COMMUNICATION

The communication requirement shall be in accordance to CEA (Technical Standards for Communication System in Power System Operations) Regulations, 2020, CEA (Technical Standards for Construction of Electrical Plants and Electric Lines) Regulations, 2022, CERC (Communication System for inter-State transmission of electricity) Regulations, 2017, and CEA (Cyber Security in Power Sector) Guidelines, 2021, all above documents as amended from time to time.

The communication services viz. SCADA, AGC (wherever applicable), VoIP, AMR and PMU have been identified as critical services and therefore shall be provisioned with 2+2 redundancy i.e. 2 channels for Main Control Centre and 2 channels for Backup Control Centre. In order to meet this requirement, suitable redundancy at port and card level need to be ensured by the TSP to avoid any single point of failure which may lead to interruption in real-time grid operation.

PMU to PDC communication (wherever required) shall be through 2 channels to the PDC (main) as there is no backup PDC at present.

Accordingly, all the hardware for communication services of station as stated above shall support dual redundancy for data transmission of station to respective main and backup RLDCs.

The complete ISTS communication system commissioned by TSP under the RFP shall be the asset of ISTS and shall be available for usage of ISTS requirements as suggested by CTU from time to time.

In order to meet the requirement for grid management and operation of substations, Transmission Service Provider (TSP) shall provide the following:

D.1.0 Establishment of 400/220 kV Bikaner-IV Pooling Station:

- (I) TSP shall supply, install and commission 3 No. FODP (96F or higher) and 1 No. FODP (72F or higher) along with panel and approach Cable (24F each) with all associated hardware fittings from gantry tower to Control Room for all the incoming lines envisaged under the present scope.
- (II) TSP shall supply, install and commission One or more STM-16 (FOTE) equipment along with panel/s supporting minimum Fifteen (15) directions with MSP (Multiplex Section Protection – 1+1). These directions shall exclude protected (1+1) local patching among equipment (if any). Communication Equipment shall be provided with necessary interfaces to meet the voice and data communication requirement among Bikaner-IV PS, Biakner-II S/s, Biakner-III S/s, Siwani S/s, es, upcoming bays for Siwani (2nd line). Necessary interfaces for

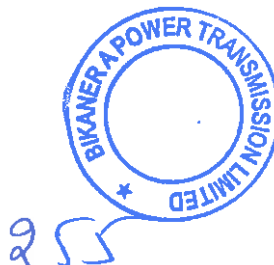

6 nos. 220 kV RE connectivities and 3 nos. 400 kV RE connectivities to be provided by the RE Generators in the FOTE of Bikaner-IV PS at the time of connectivity. Direction for these bays shall be considered by TSP in the FOTE. The suitable DC Power Supply and backup to be provided for communication equipment.

- (III) FODP and FOTE equipment with panels shall be provided in Control Room of Bikaner-IV PS. FOTE and FODP Eq can be accommodated in same panel to optimize space.
- (IV) TSP shall supply, install and commission Firewall in redundant mode (1+1) in line with the specification attached at **Annexure F.1**.
- (V) The maintenance of all the communication equipment and software thereof including FOTE, FODP, PMU, approach cable, DCPS alongwith Battery Bank and Firewall shall be the responsibility of TSP.

D.2.0 Bikaner-IV PS – Siwani 765 kV D/C line

On Bikaner-IV PS – Siwani 765 kV D/C line, TSP shall supply, install and commission One (1) No. OPGW cable containing 24 Fibres (24F) on one E/W peak and conventional earth wire on other E/W peak.

The TSP shall install this OPGW from gantry of Bikaner-IV PS up to the gantry of Siwani S/s with all associated hardware including Vibration Dampers, mid-way and gantry Joint Boxes (called **OPGW Hardware** hereafter) and finally terminate in Joint Boxes at end Substations. The transmission line length is **260 kms (approx.)**, where repeater shall be required to meet the link budget requirement of Bikaner-IV PS – Siwani 765 kV link the same shall be provided by TSP.

TSP shall **finalize** the location of the repeater station depending upon the actual site conditions. Further TSP shall comply to the requirements mentioned as per **Appendix-F.1**

Maintenance of OPGW Cable and OPGW Hardware shall be the responsibility of TSP.

D.3.0 Siwani – Fatehabad (PG) 400 kV D/C line

On Siwani – Fatehabad (PG) 400 kV D/C line, TSP shall supply, install and commission One (1) No. OPGW cable containing 24 Fibres (24F) on one E/W peak and conventional earth wire on other E/W peak.

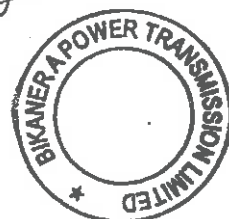
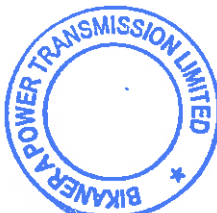
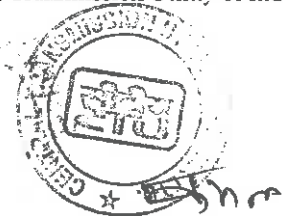

The TSP shall install this OPGW from gantry of Siwani S/s up to the gantry of Fatehabad S/s with all associated hardware including Vibration Dampers, mid-way and gantry Joint Boxes (called **OPGW Hardware** hereafter) and finally terminate in Joint Boxes at end Substations. The transmission line length is **80 kms (approx.)**, where repeater may not required to meet the link budget requirement of Siwani – Fatehabad (PG) link.

Maintenance of OPGW Cable and OPGW Hardware shall be responsibility of TSP.

D.4.0 Siwani S/s – Patran (IndiGrid) 400 kV D/C line

On Siwani S/s – Patran (Indi Grid) 400 kV D/C line, TSP shall supply, install and commission One (1) No. OPGW cable containing 24 Fibres (24F) on one E/W peak and conventional earth wire on other E/W peak.

The TSP shall install this OPGW from gantry of Siwani S/s up to the gantry of Patran (Indi Grid) with all associated hardware including Vibration Dampers, mid-way and gantry Joint Boxes (called **OPGW Hardware** hereafter) and finally terminate in Joint Boxes at end Substations. The transmission line length is **160 kms (approx.)**, where repeater may not required to meet the link budget requirement of Siwani S/s – Patran (Indi Grid) Link.

Maintenance of OPGW Cable and OPGW Hardware shall be responsibility of TSP.

D.5.0 LILO of both ckts of Bikaner II PS- Bikaner III PS (Quad) direct line at Bikaner-IV PS

On LILO of Bikaner II PS- Bikaner III PS (Quad) direct line at at Bikaner-IV PS, TSP shall supply, install and commission OPGW and earthwire as per Tower Configurations:

- (i) For Multi Circuit Tower Configuration: Two (2) No. OPGW cable containing 24 Fibres (24F) to be installed and commissioned by the TSP on both the Earthwire peaks
- (ii) For Double Circuit Tower configuration (for both Loop In and Loop Out portion): One (1) No. OPGW cable containing 24 Fibres (24F) on one earthwire peak and conventional earthwire on other E/W peak for both Loop In and Loop Out Lines.

The TSP shall install OPGW cables from gantry of Bikaner-IV PS up to the LILO tower with all associated hardware including Vibration Dampers, mid-way and

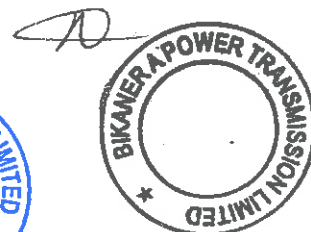

gantry Joint Boxes (called OPGW Hardware hereafter) and finally terminate in Joint Boxes at Bikaner-IV PS. The transmission line length is **20 kms (approx.)**. After L.I.O. if fiber length for links Bikaner-IV (PS) to Bikaner-II S/s and Bikaner-IV (PS) to Bikaner-III S/s is above 225 kms then repeater shall be envisaged, otherwise line can be managed as a repeater less link.

TSP shall finalize the location of repeater station depending upon the actual site conditions. Further TSP shall comply to the requirements mentioned as per **Appendix-F.1**

Maintenance of OPGW Cable and OPGW Hardware shall be responsibility of TSP.

D.6.0 FOTE requirement at Siwani S/s (for 4 Nos. of 400 kV line bays and 2 Nos. of 765 kV line bays)

- (i) TSP shall supply, install and commission 1 No. FODP (96F or higher) and 1 No. FODP (48 Fiber) alongwith panel and required Approach Cable (24F) with all associated hardware fittings from gantry tower to Bay Kiosk and from the Bay Kiosk to Control room.
- (ii) TSP shall supply, install and commission One STM-16 (FOTE) equipment alongwith panel/s supporting minimum Five (5) directions with MSP (Multiplex Section Protection – 1+1) with necessary interfaces to meet the voice and data communication requirement among Siwani S/s , Bikaner-IV PS, Fatehabad (PG), Patran (Indigrid) and local patching with Control Room FOTE. The suitable DC Power Supply and backup to be provided for communication equipment.
- (iii) FOTE/FODP panel shall be installed in the new Bay Kiosk (Switchyard Panel Room (SPR)).
- (iv) FOTE and FODP can be accommodated in same panel to optimize space.
- (v) The maintenance of all the communication equipment and software thereof including FOTE, FODP, approach cable, PMU, DCPS alongwith Battery Bank shall be the responsibility of TSP.

D.7.0 2 Nos. of 400 kV line bays at Fatehabad (PG).

Central Transmission Utility of India Limited

193

Bikaner A Power Transmission Limited

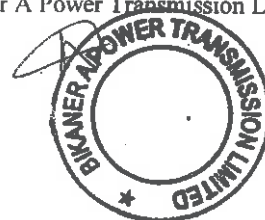
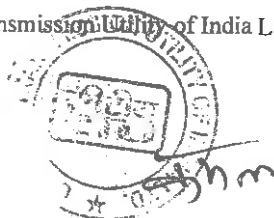

258

- (i) TSP shall supply, install and commission 1 No. FODP (72F or higher) alongwith panel and required Approach Cable (24F) with all associated hardware fittings from gantry tower to Bay Kiosk and from the Bay Kiosk to Control room.
- (ii) TSP shall supply, install and commission One STM-16 (FOTE) equipment alongwith panel/s supporting minimum three (3) directions with MSP (Multiplex Section Protection – 1+1) with necessary interfaces to meet the voice and data communication requirement between Siwani S/s and Fatehabad (PG). The suitable DC Power Supply and backup to be provided for communication equipment.
- (iii) FOTE/ FODP panel shall be installed in the new Bay Kiosk (Switchyard Panel Room (SPR)). The FOTE under present scope shall be integrated by TSP with the existing FOTE at control room of **Fatehabad (PG) S/s** which shall be communicating with respective control center. TSP to provide necessary FODP sub rack / Splice trays/ Patch cords etc. and optical interfaces/equipment in the existing FOTE/FODP panels in control room for integration with the existing FOTE for onwards data transmission.

In case spare optical direction is not available in the existing FOTE at the control room, the TSP shall coordinate with station owner to reconfigure the directions in existing FOTE at control room. Alternatively, The TSP may integrate the FOTE under the present scope with existing FOTE in the nearby Kiosk connected to the control room FOTE (if available with spare direction). For this purpose, TSP shall provide necessary FODP sub rack / Splice trays/ Patch cords etc. and suitable optical interfaces/ equipment in the existing FOTE/FODP panels in another Kiosk (SPR).

(iv) FOTE and FODP can be accommodated in same panel to optimize space.

(v) The maintenance of all the communication equipment and software thereof including FOTE, FODP, approach cable, PMU, DCPS alongwith Battery Bank shall be the responsibility of TSP.

D.8.0 2 Nos. of 400 kV line bays at Patran (Indigrid).

- (i) TSP shall supply, install and commission 1 No. FODP (72F or higher) alongwith panel and required Approach Cable (24F) with all associated hardware fittings from gantry tower to Bay Kiosk and from the Bay Kiosk to Control room.
- (ii) TSP shall supply, install and commission One STM-16 (FOTE) equipment alongwith panel/s supporting minimum three (3) directions with MSP (Multiplex



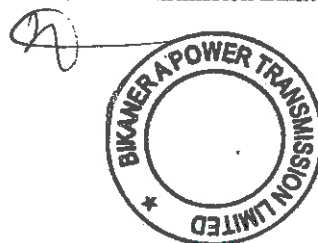

259

Section Protection – 1+1) with necessary interfaces to meet the voice and data communication requirement between Siwani S/s and Patran (Indigrid) S/s. The suitable DC Power Supply and backup to be provided for communication equipment.

- (iii) FOTE/ FODP panel shall be installed in the new Bay Kiosk (Switchyard Panel Room (SPR)). The FOTE under present scope shall be integrated by TSP with the existing FOTE at control room of Patran (Indigrid) S/s which shall be communicating with respective control center. TSP to provide necessary FODP sub rack / Splice trays/ Patch cords etc. and optical interfaces/equipment in the existing FOTE/FODP panels in control room for integration with the existing FOTE for onwards data transmission.

In case spare optical direction is not available in the existing FOTE at the control room, the TSP shall coordinate with station owner to reconfigure the directions in existing FOTE at control room. Alternatively, The TSP may integrate the FOTE under the present scope with existing FOTE in the nearby Kiosk connected to the control room FOTE (if available with spare direction). For this purpose, TSP shall provide necessary FODP sub rack / Splice trays/ Patch cords etc. and suitable optical interfaces/ equipment in the existing FOTE/FODP panels in another Kiosk (SPR).

- (iv) FOTE and FODP can be accommodated in same panel to optimize space.
- (v) The maintenance of all the communication equipment and software thereof including FOTE, FODP, approach cable, PMU, DCPS alongwith Battery Bank shall be the responsibility of TSP.

D.9.0 Specific Requirement for Phasor Measurement Units (PMUs)

TSP shall supply, install and commission required No. of Phasor Measurement Units (PMUs) at all the locations including STATCOMs under the scope of this RfP as per CEA (Technical Standards for Construction of Electrical Plants and Electric Lines) Regulations, 2022 (alongwith all amendments if any), and all the applicable Regulations, Standards, Guidelines issued time to time.

TSP shall also supply, install and commission required number of Phasor Measurement Units (PMUs) on HV side of coupling transformer at each STATCOM station and integrate with PDC.

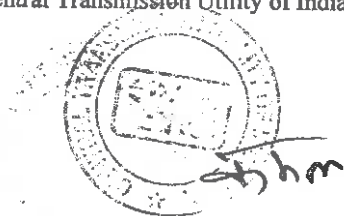

CA

260

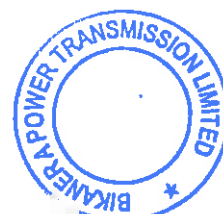
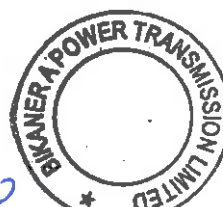

These PMUs shall be provided with GPS clock and LAN switch and shall connect with LAN switch of control room of respective substations/ generating stations with Fibre Optic cable. These PMUs shall be connected with the FOTE at Substation/ generating stations for onwards data transmission to the PDC (Phasor Data Concentrator) located at respective RLDC. Configuration work in existing PDC at RLDC for new PMU integration shall be done by respective RLDC, however all the necessary support in this regard shall be ensured by TSP. The maintenance of all the PMUs and associated equipment shall be the responsibility of TSP.

Note: Existing Station owner/s to provide necessary support to integrate different equipment and applications of new extended bays with the existing substation e.g. Communication (through FOTE), Voice etc. for smooth operation and monitoring of new added grid elements.

D.10.0 Specific Requirement for NMS/ UNMS integration

The new communication equipment/ system under the present scope shall be compatible for integration with existing regional level NMS system/ Centralized Supervision and Monitoring System (CSMS) i.e. Regional UNMS. The local configuration of the new communication equipment at the station end shall be the responsibility of TSP as per Annexure F.3. The configuration work in the existing centralized NMS/ CSMS at Control center end, for integration of new Communication equipment/ system shall be done by Regional ULDC Team/ NMT, however all the necessary support in this regard shall be ensured by TSP.

Central Transmission Utility of India Limited

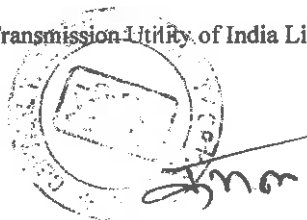

196

Bikaner A Power Transmission Limited

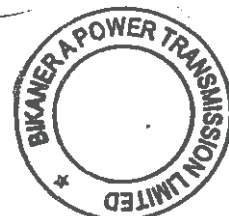

261

Appendix-F.1

Repeater Requirements

- If the repeater location is finalized in the Control Room of a nearby substation, TSP shall provide 1 no. OPGW (48F) on a single Earthwire peak with OPGW Hardware and mid-way Joint Boxes etc. of the line crossing the main line and 1 no. Approach Cable (48F) with all associated hardware fittings, to establish connectivity between crossing point of main transmission line up to the repeater equipment in substation control room. TSP shall co-ordinate for Space and DC power supply sharing for repeater equipment. TSP shall provide FODP, FOTE (with STM-16 capacity) with suitable interfaces require for link budget of respective link.

OR

- If the repeater location is finalized in the nearby substation premises, the TSP shall identify the Space for repeater shelter in consultation with station owner. Further TSP shall provide 1 no. OPGW (48F) on a single Earthwire peak with OPGW Hardware and mid-way Joint Boxes etc. of the line crossing the main line and 1 no. Approach Cable (48F) / UGFO (48F) with all associated hardware fittings, to establish connectivity between crossing point of main transmission line up to the substation where the repeater shelter is to be housed.

TSP shall provide repeater shelter along with FODP, FOTE (with STM-16 capacity) with suitable interfaces require for link budget of respective link, reliable power supply provisioning for AC and DC supply, battery bank, Air Conditioner and other associated systems.

OR

- If the repeater location is finalized on land near the transmission tower. TSP shall make the provisions for Land at nearby tower for repeater shelter. Further TSP shall provide 1 no. Approach Cable (48F) / UGFO (48F) with all associated hardware fittings to establish connectivity up to the location of repeater shelter.

TSP shall provide repeater shelter along with FODP, FOTE (with STM-16 capacity) with suitable interfaces require for link budget of respective link, reliable power supply provisioning for AC and DC supply, battery bank, Air Conditioner and other associated systems

Maintenance of OPGW Cable and OPGW Hardware, repeater equipment and items associated with repeater shelter shall be responsibility of TSP.

Central Transmission Utility of India Limited

197

Bikaner A Power Transmission Limited

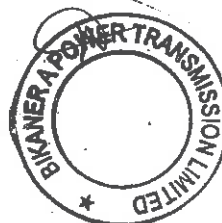
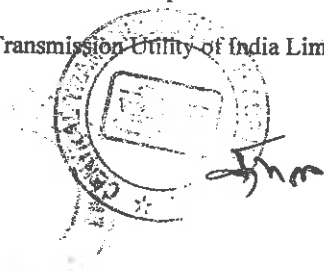

Maintenance of OPGW Cable and OPGW Hardware, repeater equipment and items associated with repeater shelter shall be responsibility of TSP

Central Transmission Utility of India Limited

198

Bikaner A Power Transmission Limited

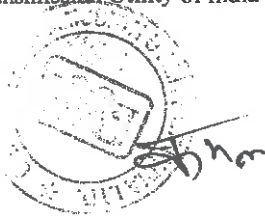

263

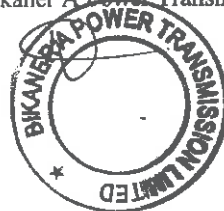

Proposed Communication for Transmission System for Evacuation of power from potential renewable energy zone in Khavda area of Gujarat under Phase IV (7 GW): Part C

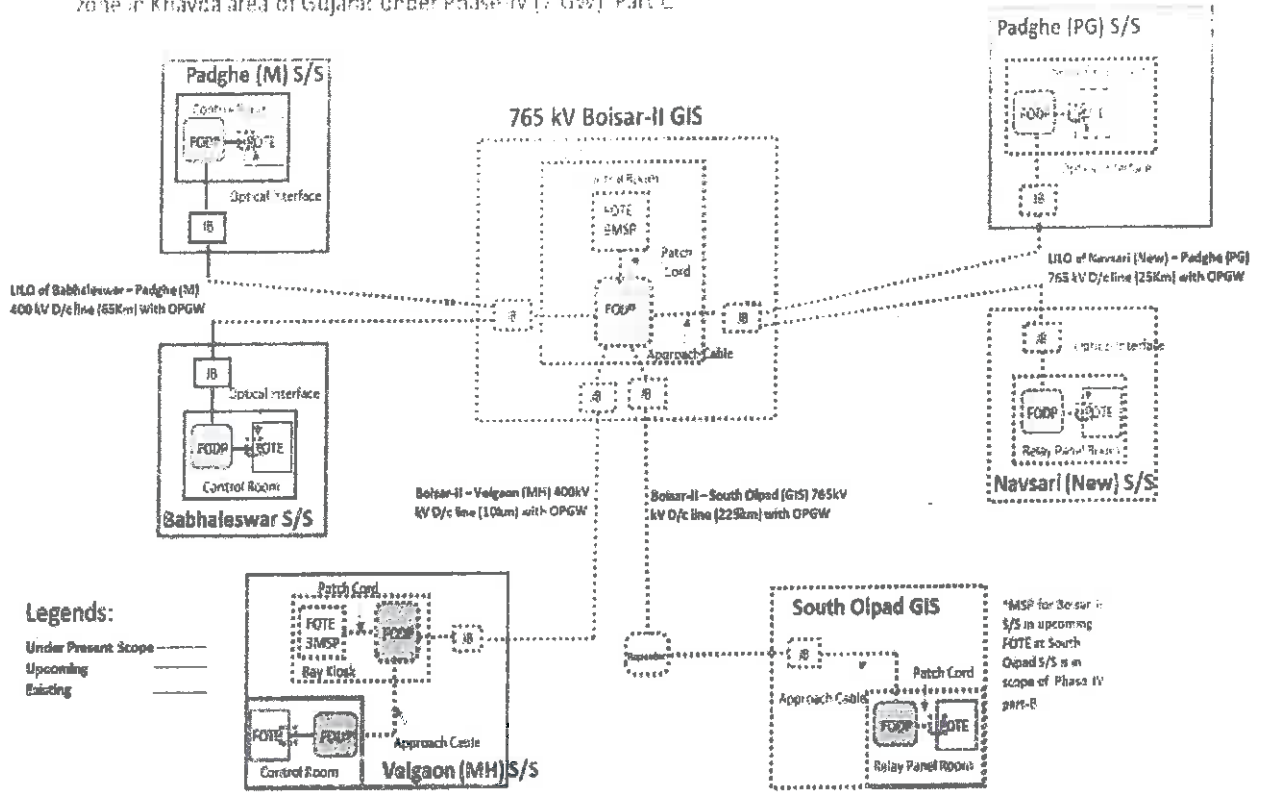
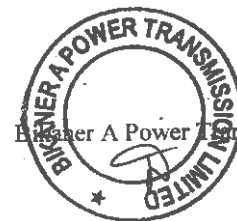
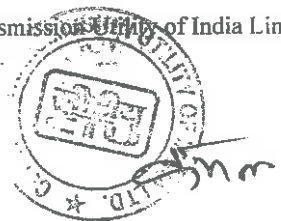

Figure F.1



Annexure-F.1

Next Generation Firewall (NGFW)

TSP shall provide 2 NGFW one in Main and another in Standby mode having electrical ethernet interfaces/ports and placed between FOTE and SAS gateway/s at the substation. All ethernet based applications shall be terminated in the firewall ports directly (e.g. PMU, AMR, VOIP, SAS/SCADA etc.). Each port of firewall shall work as a separate zone. Firewall shall be hardware based with features of Block/Allow/drop and IPSec VPN (network encryption).

The number of ports/interfaces in each firewall (i.e. Main and Standby) shall be minimum 16 Nos. TSP shall provide either single firewall or multiple firewalls to meet this interfaces requirement, each for main as well as standby firewall. Minimum throughput of firewall shall be 300 Mbps.

The Firewall shall be managed/ configured as standalone at present and shall also have compatibility to manage/configure through Centralized Management Console (CMC) remotely in future.

Firewall shall be tested and certified for ISO15408 Common Criteria for least EAL4+. Further, the OEM must certify that it conforms to Secure Product Development Life Cycle requirements as per IEC62443-4-1. The firewall shall generate reports for NERC-CIP Compliance.

The specifications for the firewalls are given at **Annexure-F.2** and schematic diagram showing firewall placement given at **Figure F.2**

Central Transmission Utility of India Limited

200

Bikaner A Power Transmission Limited

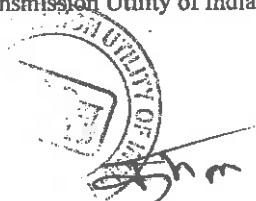

265

Annexure F.2

Specifications of Next Generation Firewall (NGFW)

1. NGFW shall have following features including but not limited to: Encryption through IPsec VPN (Virtual Private Network), Deep Packet Inspection (DPI), Denial of service (DoS) and Distributed Denial of Service (DDoS) prevention, Port Block/ Allow, rules/ policies for block/allow, IP (Internet Protocol) and Media Access Control (MAC) spoofing protection, threat detection, Intrusion Prevention System (IPS), Anti-Virus, Anti-Spyware, Man In The Middle (MITM) attack prevention.
2. The proposed firewall shall be able to handle (alert, block or allow) unknown /unidentified applications e.g. unknown TCP and UDP packets. It shall have the provision to define application control list based on application group and/or list.
3. Firewall shall have feature and also have capability to update the definition/ Signatures of Anti-Virus online as well as offline. Firewall shall also be compatible to update the definitions/signatures through CMC. There shall be a defined process for security patching and firmware up-gradation. There shall be a feature to field validate firmware checksum. The same shall also be validated before using the OEM provided file/binary in the process of firmware up-gradation and security patching
4. Firewall shall have Management Console port to configure remotely.
5. Firewall shall be EMI/EMC compliant in Substation environment as per IEC 61850-3.
6. Firewall shall be rack mounted in existing standard equipment cabinets.
7. Firewall shall have support of SCADA applications (IEC-60870-5-104), ICCP, PMU (IEEE C37.118), Sub-Station Automation System (IEC 61850), Ethernet and other substation environment protocols.
8. Client based Encryption/ VPN must support different Operating System platforms e.g. Windows, Linux and Mac.
9. The solution must have content and comprehensive file detection policies, blocking the files as function of their types, protocols and directions.
10. Firewall shall have logging facility as per standard logs/events format. Firewall shall have features to export the generated/stored logs/events in csv (Comma Separated Value) and also any other standard formats for offline usage, analysis and compliance. Firewall shall have suitable memory architecture and solution to store and be enable to export all logs/events for a period of last 90 days at any given time.
11. Firewall shall have features and be compatible with local as well as central authentication system (RADIUS, LDAP, or TACACS+) for user account and access right management. It shall also have Role Based User management feature.
12. Firewall shall have the capability to configure sufficient number of VLANs.

Central Transmission Utility of India Limited

201

Bikaner A Power Transmission Limited

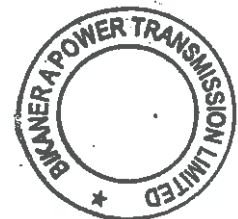
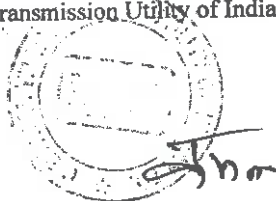

13. Firewall shall have the capability to support sufficient number of sessions.
14. Firewall shall have provision to configure multiple IP Sec VPNs, at least 100 Nos., (one-to-many or many-to-one). Shall support redundant operation with a similar router after creation of all the IP Sec VPN. IPsec VPN shall support encryption protocols as AES128, AES256 and hashing algorithms as MD5 and SHA1. IPsec VPN throughput shall support at least 300 Mbps
15. Firewall shall be capable of SNMP v3 for monitoring from Network Management system. It shall also have SNMPv3 encrypted authentication and access security
16. Firewall shall support in Active/Passive or Active-Active mode with High Availability features like load balancing, failover for firewall and IPsec VPN without losing the session connectivity.
17. Firewall should have integrated traffic shaping (bandwidth, allocation, prioritisation, etc.) functionality
18. Shall support simultaneous operation with both IPv4 and IPv6 traffic
19. Firewall shall be compatible with SNTP/NTP or any other standards for clock synchronization
20. Firewall shall have the features of port as well as MAC based security
21. Firewall shall support exporting of logs to a centralized log management system (e.g. syslog) for security event and information management.
22. Firewall time shall be kept synchronised to official Indian Timekeeping agency, time.nplindia.org.
23. Firewall product shall be provided with all applicable updates at least until 36 months since the applicable date of product shipping to the concerned utility.

Central Transmission Utility of India Limited

202

Bikaner A Power Transmission Limited

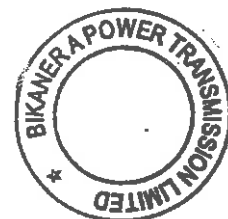
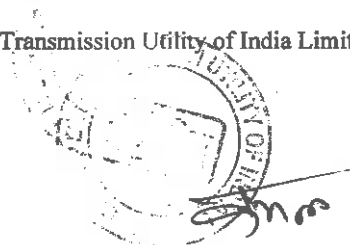

267

Firewall Placement Diagram

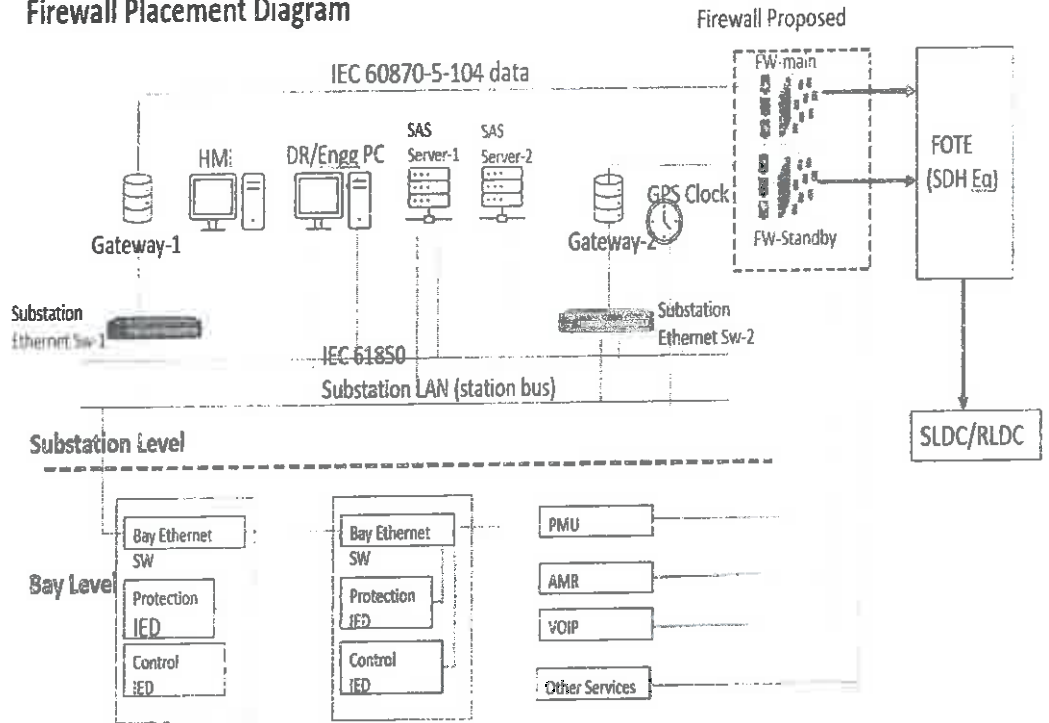
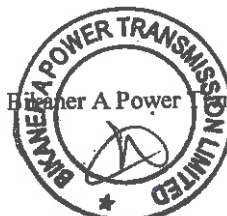
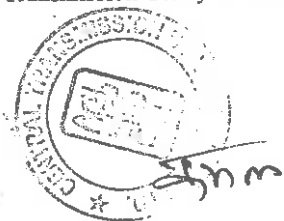

Figure F.2



Annexure F.3

Requirement for integration of Communication Equipment with Regional UNMS:

1. TSP shall ensure that NMS/EMS/NE supplied by them is NBI compliant and all FCAPS functionality is supported in the NBI such as NE Inventory, Hardware Inventory – Shelf/Slot/Card/SFP/Port, Topology, Protections, Alarms, Performance- real time and periodic, Performance KPI parameters (E-1, STM, Ethernet) , Remote Configuration, Cross Connects, Trails and Circuits. Services Provisioning (NE), E-1 , STM, Ethernet , TX and RS Trace, loop back and details are published in the NBI guide for the configuration parameters.
2. TSP shall be obliged to provide/share all necessary documentations such as NBI Guide/MIB/IDL/WSDL/API files/ etc. for onward integration of their NMS/EMS/NE with regional UNMS.
3. The following support shall be provided by TSP for integration of their supplied equipment with regional UNMS:
 - Enabling and activating NBI license in their EMS/NMS and providing NBI login access along with User credentials
 - Assist in verifying NBI Connectivity with UNMS vendor for the successful communication and retrieval of data.
 - Assist in troubleshooting (if required) for NBI connectivity along with UNMS vendor for the communication and retrieval of data.
4. For standalone NE which is not integrated with any EMS/NMS, TSP shall provide modality of complete FCAPS data acquisition as above through industry standard programmatic methods and provide the CLI command manual.

Central Transmission Utility of India Limited

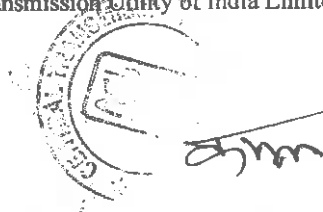

204



Bikaner A Power Transmission Limited



D.11.0 PLCC and PABX:

Power line carrier communication (PLCC) equipment complete for speech, tele-protection commands and data channels shall be provided on each transmission line. The protections for transmission line and the line compensating equipment shall have hundred percent back up communication channels i.e. two channels for tele-protection in addition to one channel for speech plus data for each direction. The PLCC equipment shall in brief include the following: -

- Coupling device, Coupling filters, line traps, carrier terminals, protection couplers, HF cables, PABX (if applicable) and maintenance and testing instruments.
- At new substation, a telephone exchange (PABX) of 24 lines shall be provided at as means of effective communication among various buildings of the substation, remote end substations and with control centres (RLDC/SLDC) etc.
- Coupling devices shall be suitable for phase-to-phase coupling for 765 kV Transmission lines. The pass band of coupling devices shall have sufficient margin for adding communication channel in future if required. Necessary protection devices for safety of personnel and low voltage part against power frequency voltages and transient over voltage shall also be provided.
- The line traps shall be broadband tuned suitable for blocking the complete range of carrier frequencies. Line Trap shall have necessary protective devices such as lightning arresters for the protection of tuning device. Decoupling network consisting of line traps and coupling capacitors may also be required at certain substation in case of extreme frequency congestion.
- The carrier terminals shall be of single sideband (SSB) amplitude modulation (AM) type and shall have 4 kHz band width. PLCC Carrier terminals and Protection couplers shall be considered for both ends of the line.
- PLCC equipment for all the transmission lines covered under the scheme (consisting of one set of analog PLCC channel along with circuit protection coupler and one set of Digital protection coupler for both ends) shall be provided by TSP. CVT and Wave trap for all the line bays under present scope shall be provided by TSP. PLCC to be provided for following lines under present scope:

TSP shall provide new set of PLCC as per following configuration:

Sl. No.	Line Section	PLCC configuration
1.	Bikaner-IV PS – Siwani 765 kV D/C line	1 set Analog PLCC and 1 set Digital Protection Coupler for each circuit at both ends.
2.	400 kV D/C Bikaner II PS- Bikaner-IV PS TL [after LILO]	1 set Analog PLCC + 1 set Digital Protection Coupler for each circuit at

Central Transmission Utility of India Limited

205

Bikaner A Power Transmission Limited

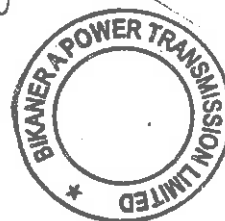
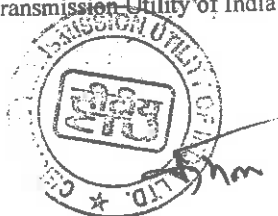

270

Transmission Service Agreement

3.	400 kV D/C Bikaner III PS - Bikaner-IV PS TL [after I.ILO]	both ends 1 set Analog PLCC + 1 set Digital Protection Coupler for each circuit at both ends.
4.	Siwani- Fatehabad (PG) 400 kV D/C line	1 set Analog PLCC and 1 set Digital Protection Coupler for each circuit at both ends.
5.	Siwani - Patran (Indi Grid) 400 kV D/C line	1 set Analog PLCC and 1 set Digital Protection Coupler for each circuit at both ends.

All other associated equipment like cabling, coupling device and HF cable shall also be provided by the TSP.

Central Transmission Utility of India Limited

206

Bikaner A Power Transmission Limited

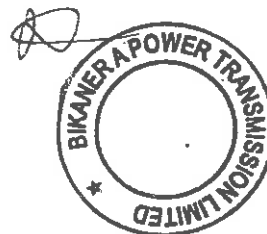

Frequently Asked Queries:**1.0** Transmission Line:

- 1.1 Please clarify that whether shutdowns for crossing of existing transmission lines of POWERGRID/STUs/ Power Evacuation Lines from Generation Plants/ Any other Transmission Licensee will be given to TSP on chargeable basis or free of cost.

Reply: Shutdowns for crossing of existing transmission lines of POWERGRID/ STUs/ Power Evacuation Lines from Generation Plants/ Any other Transmission Licensee will be given to TSP by the concerned owner of the lines as per their own terms and conditions.

- 1.2 We understand that the suggested swing angle criteria are applicable for Suspension Insulator in Suspension Tower. Further, you are requested to provide similar swing angle and clearance criteria for Pilot Insulator with Jumper and Jumper.

Reply: It is clarified that the swing angle criteria (as mentioned in RFP) for transmission lines is applicable for Suspension Insulator in Suspension Tower. Further, as per Clause 3.0 of Specific Technical Requirements for transmission lines, Transmission service Provider (TSP) shall adopt any additional loading/design criteria for ensuring reliability of the line, if so desired and /or deemed necessary.

- 1.3 We request you to kindly allow that use of diamond configuration at Power line crossings and the existing owner of the lines may be directed to allow the same for the successful bidders.

Reply: Power line crossing including Diamond configuration is responsibility of the TSP. The TSP shall formally submit the profile of the crossing section to the owner of the existing line suggesting proposed crossing alternatives. The crossing will have to be carried out as per approval of owner of the existing line.

- 1.4 It is requested you to kindly provide present status of Forest Clearances if any transmission line corridor area falling in wildlife forest / reserve forest/

Central Transmission Utility of India Limited

207

Bikaner A Power Transmission Limited

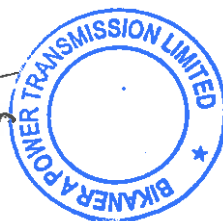
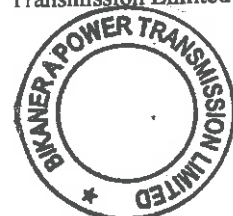
272

mangroves.

Reply: Based on the preliminary route survey, the process of initiation of forest clearance for the forest stretches, if any, enroute the proposed line alignment will be initiated by way of writing letters to the concerned authority (ies). However, it may be noted that it will be the responsibility of TSP for obtaining forest clearance for the forest stretches as provided in the survey report and also for any forest area encountered during detailed survey.

2.0 Substation

2.1 We understand that space for storage of O&M spare shall be provided by existing owner within the station boundary without any cost. Kindly confirm.

Reply: Space for storage of O&M spares shall be arranged by TSP on its own.

2.2 We presume that the O&M for the end Termination bays will be in the scope of the TSP and TSP shall not be liable for any payment towards O&M to the existing owner of the substation. Kindly confirm.

Reply: Operation and maintenance of the bays is solely responsibility of the TSP. TSP shall follow CEA's "Operation and Maintenance (O&M) guidelines and Standard Format for Memorandum of Understanding between New TSP and Existing TSP" issued by CEA vide its letter No. I/28514/2023 dated 22.06.2023. Copy of the guideline is available on CEA website at following link:

https://cea.nic.in/wp-content/uploads/pse_td/2023/06/om_guidelines.pdf

2.3 With reference to subject scheme of existing sub-station, we assumed following scope of work:

- (a) We assumed internal road is available and need not to consider in the present scope of work.
- (b) Drainage is available and need not to consider in the present scope of work.
- (c) Cable trench extension in adjacent to Main cable trench only under present scope of work.
- (d) Levelled area being provided by developer for bay extension.

Reply: Regarding requirement of internal road, drainage, cable trench, leveling of the bay extension area, bidder is advised to visit site and acquaint themselves with the provisions/facilities available at substation.

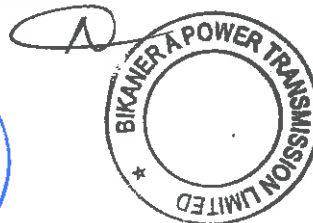
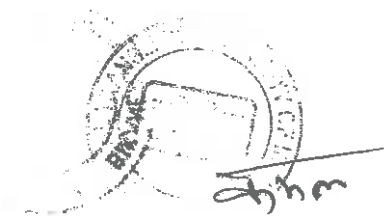

- 2.4 Kindly provide the soil investigation report of soil parameters of existing substation.
Reply: Bidder is advised to visit the substation site and ascertain the requisite parameters.
- 2.5 Kindly confirm, energy accounting of aux. power consumption. Whether it will be on chargeable basis or part of transmission loss.
Reply: It will be on chargeable basis.
- 2.6 We understand that VMS requirement is for unmanned stations only. For Manned stations VMS is not compulsory.
Reply: VMS shall be provided by TSP in line with requirements of RfP document.
- 2.7 It is understood that Construction water and power shall be provided free of cost to TSP by respective substation owner for construction of new bays.
Reply: Arrangement of construction power and water is in the scope of TSP.
- 2.8 It is understood that existing fire hydrant system shall be extended by the TSP for bay extension.
Reply: Existing fire hydrant system shall be extended from existing system (if required)
- 2.9 Please clarify that Status of land acquisition for Substations. Whether the lands have been acquired by BPC and will be transferred to TSP.
Reply: The acquisition of land for substation is in the scope of TSP.
- 2.10 We understood that no any dedicated metering CT and CVT required for Line/feeders. Further, we understood that requisite Energy meters for various 765 kV, 400 kV and 220 kV Feeders shall be provided and installed by CTU free of cost to TSP.
Reply: Dedicated metering CT and CVT are not required for line/feeders. Metering core of existing CT/CVT can be used provided accuracy class is matching with metering requirement. Requisite Special Energy Meters shall be provided and installed by CTU in C&P panel subject to space availability, else, in separate metering panel (to be provided by TSP at its cost).

3.0 Communication

- 3.1 What are the usage of OPGW, FOTE, PMU etc. under communication requirement of RFP?

Central Transmission Utility of India Limited

209

Bikaner A Power Transmission Limited

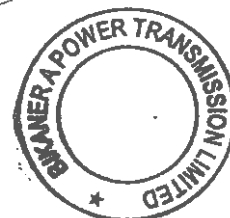
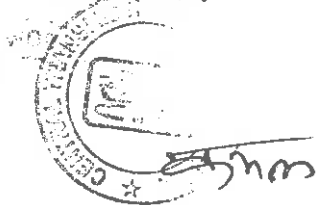

Reply: User shall be responsible for providing compatible equipment along with appropriate interface for uninterrupted communication with the concerned control center and shall be responsible for successful integration with the communication system provided by CTU. Communication systems comprising OPGW, FOTE, PMU etc. are required for grid operation through RLDC/SLDC, speech communication, tele-protection and tele-metering.

3.2 Is space for installation of communication panels are provided to TSP in existing Substations incase new bays are in the scope of TSP?

Reply: The space related issues are deliberated in the RFP itself. TSP to carry out survey of the existing substation for physical space requirement. In case space is not available in the existing substation then TSP shall accommodate the same in the respective bay SPR (Switchyard Panel Room)/Bay Kiosk/ Relay panel room in case of GIS s/s. Further, TSP to connect and integrate the proposed FOTE with the existing FOTE in the control room.

In Case 132 kV Substation TSP shall accommodate the said panels either by extension of existing control room or other arrangements.

3.3 How is the OPGW laying done in case of LILO lines?

Reply: In case LILO lines are on same towers (e.g. both Line in and Line Out portion are on same towers, generally done LILO of S/C lines), then 2x24F OPGW shall be required to install by TSP on both earthwire peak on 400 kV and 765 kV lines where two E/W peaks are available. On 220 kV and 132 kV lines where only one E/W peak is available TSP to install one No. 48F OPGW.

Incase LILO lines are on different towers (e.g. both Line In and Line Out portion are on different towers, generally done LILO of D/C lines), then 1x24F OPGW shall be required to install by TSP on one earthwire peak, on both Line In and Line Out portions of 400 kV and 765 kV lines. On 220 kV and 132 kV lines where only one E/W peak is available TSP to install one No. 24F OPGW in place of conventional earthwire.

3.4 How is the OPGW laying done in case Multi circuit Towers?

Central Transmission Utility of India Limited

210

Bikaner A Power Transmission Limited

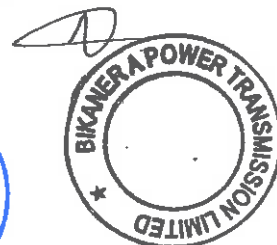

275

Reply: In case two different lines are using common multi circuit portion for some distance (originating from different stations, may be terminating on same or on different stations), two No. 24F OPGW to be installed on both E/W peaks for common M/C portion of 765 kV and 400 kV lines.

In case 220/132 kV lines using multi circuit portion where single E/W peak is available one No. 48F may be installed for common multi circuit portion.

Central Transmission Utility of India Limited

211

Bikaner A Power Transmission Limited

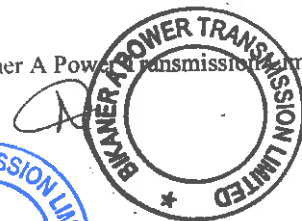
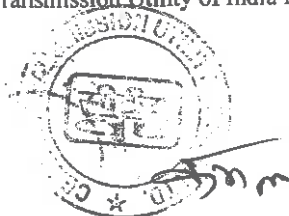

Schedule: 2

Scheduled COD

[Note: As referred to in the definition of "Element", "Scheduled COD", and in Articles 3.1.3 (c), 4.1 (b) and 4.3 (a) of this Agreement]

Sl. No.	Scope of the Transmission Scheme	Scheduled COD from effective date	Percentage of Quoted Transmission Charges recoverable on Scheduled COD of the Element of the Project	Element(s) which are pre-required for declaring the commercial operation (COD) of the respective Element
1.	Establishment of 6x1500 MVA, 765/400 kV and 6x500 MVA, 400/220 kV Bikaner-IV Pooling Station along with 2x240 MVA (765 kV) and 2x125 MVA (420kV) Bus Reactors at a suitable location near Bikaner	11/11/2026	100%	All elements of scheme are required to be commissioned simultaneously as their utilization is dependent on each other
2.	STATCOM (2x±300 MVA) along with MSC (4x125 MVA) and MSR (2x125 MVA) at Bikaner-IV PS			
3.	LILO of both ckts of Bikaner II PS- Bikaner III PS (Quad) direct 400 kV line at Bikaner-IV PS			
4.	Bikaner-IV PS – Siwani 765 kV D/C line along with 240 MVA			

Central Transmission Utility of India Limited

212

Bikaner Power Transmission Limited

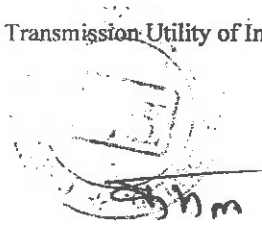

277

Sl. No.	Scope of the Transmission Scheme	Scheduled COD from effective date	Percentage of Quoted Transmission Charges recoverable on Scheduled COD of the Element of the Project	Element(s) which are pre-required for declaring the commercial operation (COD) of the respective Element
	switchable line reactor for each circuit at each end			
5.	Siwani– Fatehabad (PG) 400 kV D/C line (Quad)			
6.	Siwani – Patran (Indi Grid) 400 kV D/C line (Quad) along with 80 MVAR switchable line reactor for each circuit at Siwani S/s end			
7.	2 Nos. 400 kV line bays each at Fatehabad (PG) and Patran (Indi Grid) GIS S/s			
8.	2 Nos. 765 kV line bays at Siwani S/s			
9.	4 Nos. 400 kV line bays at Siwani S/s			

Central Transmission Utility of India Limited

213

Bikaner Power Transmission Limited

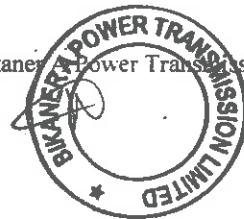
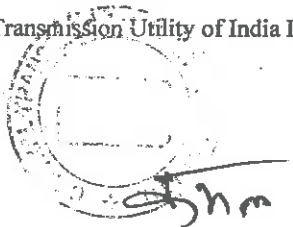

Schedule: 3

Safety Rules and Procedures

[Note: As referred to in Articles 5.6 of this Agreement]

1: Site Regulations and Safety:

The TSP shall establish Site regulations within sixty (60) days from fulfilment of conditions subsequent, as per Prudent Utility Practices setting out the rules to be observed till expiry of the Agreement at the Site and shall comply therewith.

Such Site regulations shall include, but shall not be limited to, rules in respect of security, safety of the Project, gate control, sanitation, medical care, and fire prevention, public health, environment protection, security of public life, etc.

Copies of such Site regulations shall be provided to the Nodal Agency and the CEA for the purpose of monitoring of the Project.

2: Emergency Work:

In cases of any emergency, the TSP shall carry out all necessary remedial work as may be necessary.

If the work done or caused to be done by any entity, other than the TSP, the TSP shall, reimburse the actual costs incurred, to the other Party carrying out such remedial works.

3: Site Clearance:

In the course of execution of the Agreement, the TSP shall keep the Site reasonably free from all unnecessary obstruction, storage, remove any surplus materials, clear away any wreckage, rubbish and temporary works from the Site, and remove any equipment no longer required for execution of the Agreement. After completion of all Elements of the Project, the TSP shall clear away and remove all wreckage, rubbish and debris of any kind from the Site, and shall leave the Site clean and safe.

4: Watching and Lighting:

The TSP shall provide and maintain at its own expense all lighting, fencing, and watching when and where necessary for the proper construction, operation, maintenance / repair of any of the Elements of the Project, or for the safety of the owners and occupiers of adjacent property and for the safety of the public, during such maintenance / repair.

Central Transmission Utility of India Limited

214

Bikaner A Power Transmission Limited

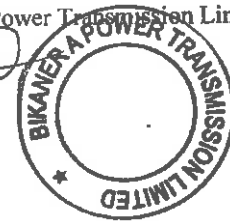
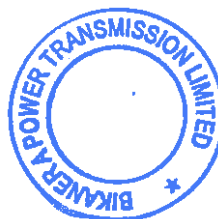
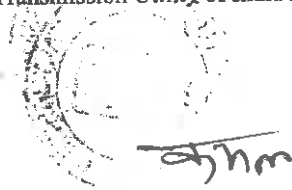

Schedule: 4

Computation of Transmission Charges

1.1 General

The Monthly Transmission Charges to be paid to the TSP for providing Transmission Service for any Contract Year during the term of the Agreement shall be computed in accordance with this Schedule and paid as per Sharing Regulations.

Illustration regarding payment of Transmission Charges under various scenarios (considering definitions of Contract Year, Expiry Date & Monthly Transmission Charges above) is as below: -

Illustration-1: In case the Project Elements achieve COD as per Schedule

Quoted Transmission Charges: **Rs. 140 Million**

Completion Schedule:

Element No.	Completion Schedule in Months	Scheduled CoD of the Element	Actual CoD of the Element	% Charges recoverable on Scheduled CoD of the Element
Element 1	28	1-Feb-2018	1-Feb-2018	25%
Element 2	38	1-Dec-2018	1-Dec-2018	75%

Tariff Payable as follows:

Transmission Charges for Element 1			Transmission Charges for Element 2		
1-Feb-18 to 31-Mar-18	140 X 25% X ((28+31)/365)	5.65		--	0.00
1-Apr-18 to 30-Nov-18	140 X 25% X (244/365)	23.39		--	0.00
1-Dec-18 to 31-Mar-19	140 X 100% X (121/365)				46.41
2	140 X 100% X 1				140
3	140 X 100% X 1				140
4	140 X 100% X 1				140
5	140 X 100% X 1				140
.....					
.....					
36 (1-Apr to 30-Nov)	140 X 100% X (244/365)				93.59

Central Transmission Utility of India Limited

215

Bikaner A Power Transmission Limited

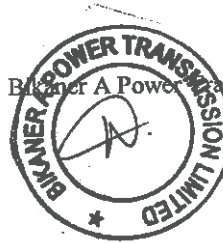
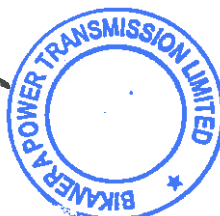
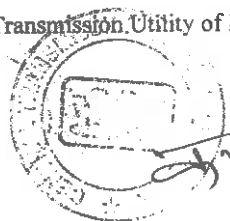

Illustration-2: In case of extension of Scheduled CoD as per Article 4.4.1 & 4.4.2 of this AgreementQuoted Transmission Charges: **Rs. 140 Million**

Completion Schedule:

Element No.	Completion Schedule in Months	Scheduled CoD of the Element	Actual CoD of the Element	% Charges recoverable on Scheduled CoD of the Element
Element 1	20	1-Feb-2018	1-Jul-2018	25%
Element 2	28	1-Oct-2018	1-Dec-2018	75%

Tariff Payable as follows:

Transmission Charges for Element 1			Transmission Charges for Element 2		
1-Feb-18 to 31-Mar-18	--	0.00		--	0.00
1-Apr-18 to 30-Jun-18	--	0.00		--	0.00
1-Jul-18 to 30-Nov-18	140 X 25% X (153/365)	14.67		--	0.00
1-Dec-18 to 31-Mar-19	140 X 100% X (121/365)				46.41
2	140 X 100% X 1				140
3	140 X 100% X 1				140
4	140 X 100% X 1				140
5	140 X 100% X 1				140
.....					
.....					
36 (1-Apr to 30-Nov)	140 X 100% X (244/365)				93.59

Central Transmission Utility of India Limited

216

Bikaner A Power Transmission Limited

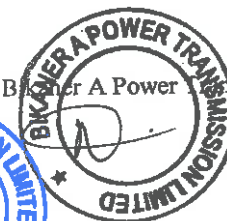
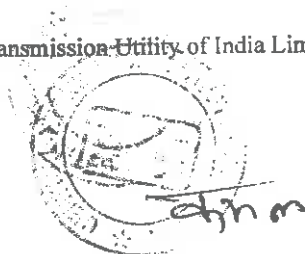

**Illustration-3: In case of delay in achieving COD of Project & all individual Elements
(COD of the Project achieved in Contract Year 1)**

Quoted Transmission Charges: Rs. 140 Million

Completion Schedule:

Element No.	Completion Schedule in Months	Scheduled CoD of the Element	Actual CoD of the Element	% Charges recoverable on Scheduled CoD of the Element
Element 1	20	1-Feb-2018	1-Dec-2018	25%
Element 2	28	1-Oct-2018	1-Dec-2018	75%

Tariff Payable as follows:

Transmission Charges for Element 1			Transmission Charges for Element 2		
1-Feb-18 to 31-Mar-18	--	0.00		--	0.00
1-Apr-18 to 30-Sept-18	--	0.00		--	0.00
1-Oct-18 to 30-Nov-18	--	0.00	1-Oct-18 to 30-Nov-18	--	0.00
1-Dec-18 to 31-Mar-19	140 X 100% X (121/365)				46.41
2	140 X 100% X 1				140
3	140 X 100% X 1				140
4	140 X 100% X 1				140
5	140 X 100% X 1				140
.....					
.....					
36 (1-Apr to 30-Nov)	140 X 100% X (244/365)				93.59

Central Transmission Utility of India Limited

217

Bikaner A Power Transmission Limited

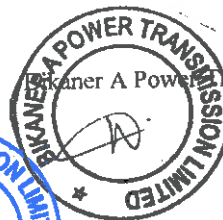
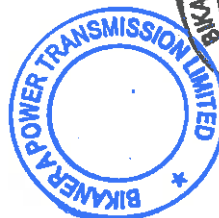
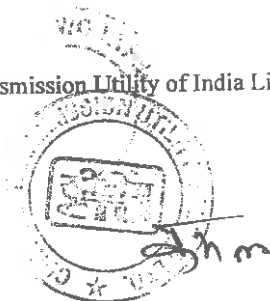

282

Illustration-4: In case of delay in achieving COD of Project & all individual Elements (COD of the Project achieved in Contract Year other than Contract Year 1)

Quoted Transmission Charges: **Rs. 140 Million**

Completion Schedule:

Element No.	Completion Schedule in Months	Scheduled CoD of the Element	Actual CoD of the Element	% Charges recoverable on Scheduled CoD of the Element
Element 1	38	1-Oct-2019	1-May-2020	25%
Element 2	38	1-Oct-2019	1-May-2020	75%

Tariff Payment to be paid as:

Transmission Charges for Element 1			Transmission Charges for Element 2		
1-Oct-19 to 31-Mar-20	--	0.00	1-Oct-19 to 31-Mar-20	--	0.00
1-Apr-20 to 30-Apr-20	-	0.00	1-Apr-20 to 30-Apr-20	-	0.00
1-May-20 to 31-Mar-21	140 X 100% X (335/365)				128.49
2	140 X 100% X 1				140
3	140 X 100% X 1				140
4	140 X 100% X 1				140
5	140 X 100% X 1				140
.....					
.....					
36 (1-Apr to 30-Apr)	140 X 100% X (30/ 365)				11.51

Central Transmission Utility of India Limited

218

Bikaner A Power Transmission Limited

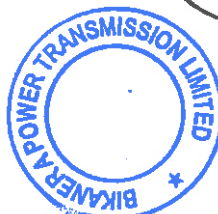

283

Illustration 5: In case of delay in achieving COD of Element but Project COD achieved on time

Quoted Transmission Charges: Rs. 140 Million

Completion Schedule:

Element No.	Completion Schedule in Months	Scheduled CoD of the Element	Actual CoD of the Element	% Charges recoverable on Scheduled CoD of the Element
Element 1	20	1-Feb-2018	1-Jul-2018	25%
Element 2	30	1-Dec-2018	1-Dec-2018	75%

Tariff Payable as follows:

Transmission Charges for Element 1			Transmission Charges for Element 2		
1-Feb-18 to 31-Mar-18	--	0.00		--	0.00
1-Apr-18 to 30-Jun-18	--	0.00		--	0.00
1-Jul-18 to 30-Nov-18	140 X 25% X (153/365)	14.67		--	0.00
1-Dec-18 to 31-Mar-19	140 X 100% X (121/365)				46.41
2	140 X 100% X 1				140
3	140 X 100% X 1				140
4	140 X 100% X 1				140
5	140 X 100% X 1				140
.....					
.....					
36 (1-Apr to 30-Nov)	140 X 100% X (244/365)				93.59

Central Transmission Utility of India Limited

219

Bikaner A Power Transmission Limited

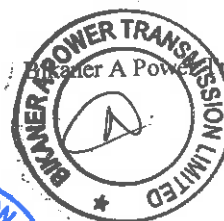
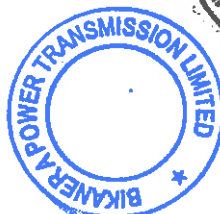
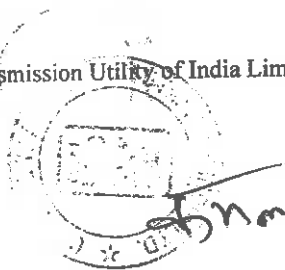

284

Illustration-6: In case of early commissioning of Project

Quoted Transmission Charges: **Rs. 140 Million**

Completion Schedule:

Element No.	Completion Schedule in Months	Scheduled CoD of the Element	Actual CoD of the Element	% Charges recoverable on Scheduled CoD of the Element
Element 1	38	1-Oct-2019	1-Jul-2019	25%
Element 2	38	1-Oct-2019	1-Jul-2019	75%

Tariff Payment to be paid as:

Transmission Charges for Element 1		Transmission Charges for Element 2	
1-July-19 to 31-Mar-20	140 X 100% X (274/365)		105.09
2	140 X 100% X 1		140
3	140 X 100% X 1		140
4	140 X 100% X 1		140
5	140 X 100% X 1		140
.....			
.....			
36 (i-Apr to 30-Jun)	140 X 100% X (91/365)		34.91

Central Transmission Utility of India Limited

220



Bikaner A Power Transmission Limited

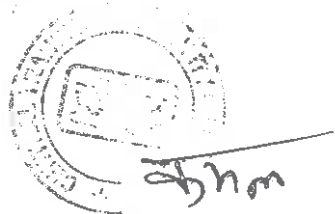

285

Illustration-7: In case of early commissioning of an elementQuoted Transmission Charges: **Rs. 140 Million**

Completion Schedule:

Element No.	Completion Schedule in Months	Scheduled CoD of the Element	Actual CoD of the Element	% Charges recoverable on Scheduled CoD of the Element
Element 1	38	1-Oct-2019	1-Apr-2019	25%
Element 2	38	1-Jul-2019	1-Jul-2019	75%

Tariff Payment to be paid as:

Transmission Charges for Element 1			Transmission Charges for Element 2		
1-Apr-2019 to 30-Jun-19	140 X 25% X (91/365)	8.72	1-Apr-2019 to 30-Jun-19	--	0.00
1-July-19 to 31-Mar-20	140 X 100% X (274/ 365)				105.09
2	140 X 100% X 1				140
3	140 X 100% X 1				140
4	140 X 100% X 1				140
5	140 X 100% X 1				140
.....					
.....					
36 (1-Apr-30-Jun)	140 X 100% X (91/365)				34.91

The Transmission Charges shall be payable on monthly basis as computed above.

1.2 Computation of Monthly Transmission Charges

The Monthly Transmission Charges for any month m in a Contract Year n shall be calculated as below:

For AC System:

Central Transmission Utility of India Limited

221

Bikaner A Power Transmission Limited

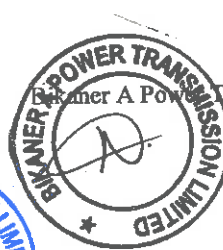
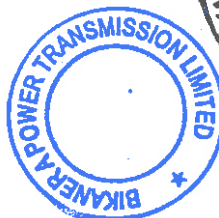
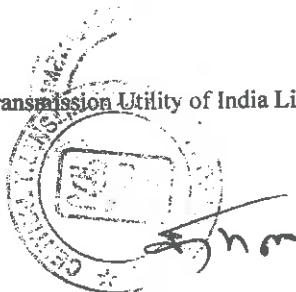

- a. If Actual Transmission System Availability for the month m of contract year n is greater than or equal to 98% and less than or equal to 98.5%;

$$\text{Monthly Transmission Charges MTC}(m) = T_{mn} * 1$$

- a. If Actual Transmission System Availability for the month m of contract year n exceeds 98.5% and less than or equal to 99.75%;

$$\text{Monthly Transmission Charges MTC}(m) = T_{mn} * (AA / 98.5\%)$$

- c. If Actual Transmission System Availability for the month m of contract year n is greater than 99.75%;

$$\text{Monthly Transmission Charges MTC}(m) = T_{mn} * (99.75\% / 98.5\%)$$

- d. If Actual Transmission System Availability for the month m of contract year n is less than 98% and greater than or equal to 95.00%;

$$\text{Monthly Transmission Charges MTC}(m) = T_{mn} * (AA / 98\%)$$

- e. If Actual Transmission System Availability for the month m of contract year falls below 95%;

$$\text{Monthly Transmission Charges MTC}(m) = T_{mn} * (AA / 98\%) - 0.02 * (T_{mn} * (AA / 95\%))$$

For DC System:

- a. If Actual Transmission System Availability for the month m of contract year n is greater than or equal to 95% and less than or equal to 96%;

$$\text{Monthly Transmission Charges MTC}(m) = T_{mn} * 1$$

- b. If Actual Transmission System Availability for the month m of contract year n exceeds 96% and less than or equal to 99.75%;

$$\text{Monthly Transmission Charges MTC}(m) = T_{mn} * (AA / 96\%)$$

- c. If Actual Transmission System Availability for the month m of contract year n is greater than 99.75%;

$$\text{Monthly Transmission Charges MTC}(m) = T_{mn} * (99.75\% / 96\%)$$

- d. If Actual Transmission System Availability for the month m of contract year n is less than 95% and greater than or equal to 92.00%;

$$\text{Monthly Transmission Charges MTC}(m) = T_{mn} * (AA / 95\%)$$

- e. If Actual Transmission System Availability for the month m of contract year falls below 92%;

Central Transmission Utility of India Limited

222

Bikaner Power Transmission Limited

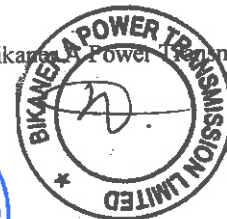
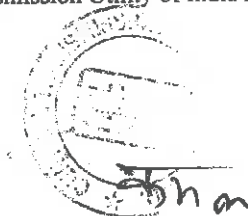

287

Monthly Transmission Charges $MTC(m) = Tmn * (AA/95\%) - 0.02 * (Tmn * (AA/92\%))$

where:

- AA is the actual Availability, as certified by RPC, as per procedure provided in Schedule 6.
- m is the month in Contract Year 'n'
- $Tmn =$ Transmission Charges for the month 'm' in Contract Year 'n' = $(= \text{Transmission Charge/ no. of days in the Year n}) * \text{no. of days in month m}$

Provided, no Transmission Charges shall be paid during the period for which the RLDC has not allowed the operation of the Element/Project due to the failure of the TSP to operate it as per the provisions of the Grid Code.

1.3 RLDC Fee & Charges

The payment of RLDC fee & charges, in accordance with relevant regulations of CERC, shall be the responsibility of the TSP.

Central Transmission Utility of India Limited

223

Bikaner Power Transmission Limited

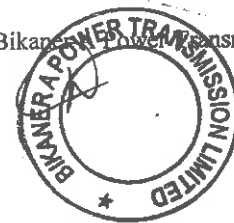
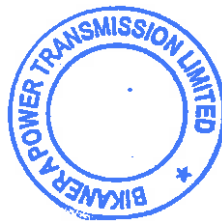
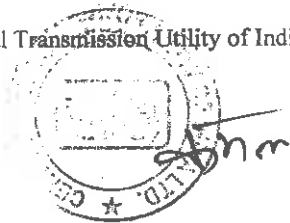

288

Schedule: 5

Quoted Transmission Charges

[Quoted Transmission Charges from Annexure - 21 of the RFP of the Selected Bidder to be inserted here]

[To be incorporated from the Bid of the Selected Bidder submitted during the e-reverse auction after its selection]

Quoted Transmission Charges: Rs. 5879.06 Million

Proportionate Transmission Charges payable for each Element of the Project:

Sl. No.	Scope of the Transmission Scheme	Scheduled COD from effective date	Percentage of Quoted Transmission Charges recoverable on Scheduled COD of the Element of the Project	Element(s) which are pre-required for declaring the commercial operation (COD) of the respective Element
1.	Establishment of 6x1500 MVA, 765/400 kV and 6x500 MVA, 400/220 kV Bikaner-IV Pooling Station along with 2x240 MVAR (765 kV) and 2x125 MVAR (420kV) Bus Reactors at a suitable location near Bikaner	11/11/2026	100%	All elements of scheme are required to be commissioned simultaneously as their utilization is dependent on each other
2.	STATCOM (2x±300 MVAR) along with MSC (4x125 MVAR) and MSR (2x125 MVAR) at Bikaner-IV PS			
3.	LILLO of both ckts of Bikaner II PS- Bikaner III PS (Quad) direct 400 kV line at Bikaner-IV PS			
4.	Bikaner-IV PS – Siwani 765 kV D/C line along with 240 MVAR			

Central Transmission Utility of India Limited

224

Bikaner A Power Transmission Limited

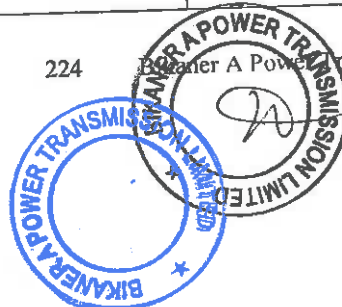

289

Sl. No.	Scope of the Transmission Scheme	Scheduled COD from effective date	Percentage of Quoted Transmission Charges recoverable on Scheduled COD of the Element of the Project	Element(s) which are pre-required for declaring the commercial operation (COD) of the respective Element
	switchable line reactor for each circuit at each end			
5.	Siwani– Fatehabad (PG) 400 kV D/C line (Quad)			
6.	Siwani – Patran (Indi Grid) 400 kV D/C line (Quad) along with 80 MVAR switchable line reactor for each circuit at Siwani S/s end			
7.	2 Nos. 400 kV line bays each at Fatehabad (PG) and Patran (Indi Grid) GIS S/s			
8.	2 Nos. 765 kV line bays at Siwani S/s			
9.	4 Nos. 400 kV line bays at Siwani S/s			

Central Transmission Utility of India Limited

225

Bikaner A Power Transmission Limited

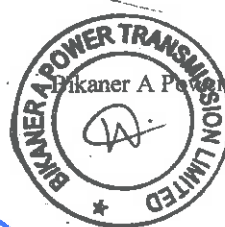
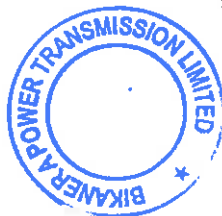

290

Appendix -IV to Central Electricity Regulatory Commission (Terms and Conditions of Tariff) Regulations, 2024

**Procedure for Calculation of Transmission System
Availability Factor for a Month**

1. Transmission system availability factor for nth calendar month ("TAFPn") shall be calculated by the respective transmission licensee, verified by the concerned Regional Load Dispatch Centre (RLDC) and certified by the Member-Secretary, Regional Power Committee of the region concerned, separately for each AC and HVDC transmission system and grouped according to sharing of transmission charges. In the case of the AC system, transmission System Availability shall be calculated separately for each Regional Transmission System and inter-regional transmission system. In the case of the HVDC system, transmission System Availability shall be calculated on a consolidated basis for all inter-state HVDC systems.
2. Transmission system availability factor for nth calendar month ("TAFPn") shall be calculated by considering the following:
 - i) **AC transmission lines:** Each circuit of AC transmission line shall be considered as one element;
 - ii) **Inter-Connecting Transformers (ICTs):** Each ICT bank (three single-phase transformers together) shall form one element;
 - iii) **Static VAR Compensator (SVC):** SVC, along with SVC transformer, shall form one element;
 - iv) **Bus Reactors or Switchable line reactors:** Each Bus Reactors or Switchable line reactors shall be considered as one element;
 - v) **HVDC Bi-pole links:** Each pole of the HVDC link, along with associated equipment at both ends, shall be considered as one element;
 - vi) **HVDC back-to-back station:** Each block of the HVDC back-to-back station shall be considered as one element. If the associated AC line (necessary for the transfer of inter-regional power through the HVDC back-to-back station) is not available, the HVDC back-to-back station block shall also be considered unavailable;
 - vii) **Static Synchronous Compensation ("STATCOM"):** Each STATCOM shall be considered as a separate element.
3. The Availability of the AC and HVDC portion of the Transmission system shall be calculated by considering each category of transmission elements as under:

Central Transmission Utility of India Limited

226

Bikaner Power Transmission Limited

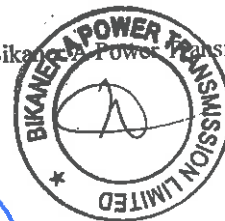

TAFPM (in %) for AC system:

$$\frac{\sum_{o=1}^o AV_o \times \sum_{p=1}^p AV_p \times \sum_{q=1}^q AV_q \times \sum_{r=1}^r AV_r \times \sum_{u=1}^u AV_u}{100 \times (p \times q \times r \times u)}$$

Where,

- o** = Total number of AC lines.
- AV_o** = Availability of o number of AC lines
- p** = Total number of bus reactors/switchable line reactors
- AV_p** = Availability of p number of bus reactors/switchable line reactors
- q1** = Total number of ICTs
- AV_q** = Availability of q number of ICTs
- r** = Total number of SVCs
- AV_r** = Availability of r number of SVCs
- u** = Total number of STATCOM
- AV_u** = Availability of u number of STATCOM

TAFMn (in %) for HVDC System:

$$\frac{\sum_{x=1}^s C_{xbp}(\text{act}) \times AV_{xbp} + \sum_{y=1}^i C_{ybtb}(\text{act}) \times AV_{ybtb}}{\sum_{x=1}^s C_{xbp} + \sum_{y=1}^i C_{ybtb}} \times 100$$

$$\sum_{x=1}^s C_{xbp} + \sum_{y=1}^i C_{ybtb}$$

Where

- C_{xbp}(act)** = Total actual operated capacity of xth HVDC pole
- C_{xbp}** = Total rated capacity of xth HVDC pole
- AV_{xbp}** = Availability of xth HVDC pole
- C_{ybtb}(act)** = Total actual operated capacity of yth HVDC back-to-back station block
- C_{ybtb}** = Total rated capacity of yth HVDC back-to-back station block
- AV_{ybtb}** = Availability of yth HVDC back-to-back station block
- s** = Total no of HVDC poles
- i** = Total no of HVDC Back to Back blocks

Central Transmission Utility of India Limited

227

Bikaner A Power Transmission Limited

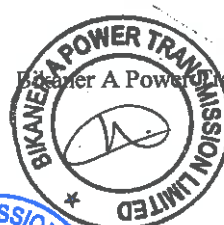
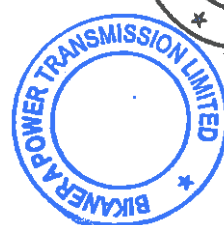
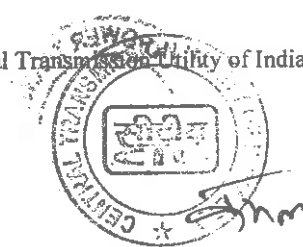

4. The availability for each category of transmission elements shall be calculated based on the weightage factor, total hours under consideration and non-available hours for each element of that category. The formulae for calculation of the Availability of each category of the transmission elements are as per **Appendix-V**. The weightage factor for each category of transmission elements shall be considered as under:
- (a) For each circuit of the AC line – The number of sub-conductors in the line multiplied by ckt-km;
 - (b) For each HVDC pole- The rated MW capacity x ckt-km;
 - (c) For each ICT bank – The rated MVA capacity;
 - (d) For SVC- The rated MVAR capacity (inductive and capacitive);
 - (e) For Bus Reactor/switchable line reactors – The rated MVAR capacity;
 - (f) For HVDC back-to-back stations connecting two Regional grids- Rated MW capacity of each block; and
 - (g) For STATCOM – Total rated MVAR Capacity.
5. The transmission elements under outage due to the following reasons shall be deemed to be available:
- i. Shut down availed for maintenance of another transmission scheme or construction of new element or renovation/upgradation/additional capitalization in an existing system approved by the Commission. If the other transmission scheme belongs to the transmission licensee, the Member Secretary, RPC may restrict the deemed availability period to that considered reasonable by him for the work involved. In case of a dispute regarding deemed availability, the matter may be referred to the Chairperson, CEA, within 30 days.
 - ii. Switching off of a transmission line to restrict over-voltage and manual tripping of switched reactors as per the directions of the concerned RLDC.
 - iii. Shut down of a transmission line due to the Project(s) of NHAI, Railways and Border Road Organization, including for shifting or modification of such transmission line or any other infrastructure project approved by Ministry of Power. Member Secretary, RPC may restrict the deemed availability period to that considered reasonable by him for the work involved; Provided that apart from the deemed availability, any other costs involved in the process of such shutdown of transmission line shall not be borne by the DICs.
- Provided that such deemed availability shall be considered only for the period for which DICs are not affected by the shutdown of such transmission line.
6. For the following contingencies, the outage period of transmission elements, as certified by the Member Secretary, RPC, shall be excluded from the total time of the element under the period of consideration for the following contingencies:

Central Transmission Utility of India Limited

228



Bikaner A Power Transmission Limited



- i) Outage of elements due to force majeure events beyond the control of the transmission licensee. However, whether the same outage is due to force majeure (not design failure) will be verified by the Member Secretary, RPC. A reasonable restoration time for the element shall be considered by the Member Secretary, RPC, and any additional time taken by the transmission licensee for restoration of the element beyond the reasonable time shall be treated as outage time attributable to the transmission licensee. Member Secretary, RPC may consult the transmission licensee or any expert for estimation of reasonable restoration time. Circuits restored through ERS (Emergency Restoration System) shall be considered as available;
 - ii) Outage caused by grid incident/disturbance not attributable to the transmission licensee, e.g. faults in a substation or bays owned by another agency causing an outage of the transmission licensee's elements, and tripping of lines, ICTs, HVDC, etc., due to grid disturbance. However, if the element is not restored on receipt of direction from RLDC while normalizing the system following grid incident/disturbance within reasonable time, the element will be considered not available for the period of outage after issuance of RLDC's direction for restoration;
 - iii) The outage period which can be excluded for the purpose of sub-clause (i) and (ii) of this clause shall be declared as under:
 - a. Maximum up to one month by the Member Secretary, RPC;
 - b. Beyond one month and up to three months after the decision at RPC;
 - c. Beyond three months by the Commission for which the transmission license shall approach the Commission along with reasons and steps taken to mitigate the outage and restoration timeline.
7. Time frame for certification of transmission system availability: (1) The following schedule shall be followed for certification of availability by the Member Secretary of the concerned RPC:
- Submission of outage data along with documentary proof (if any) and TAFPn calculation by Transmission Licensees to RLDC/ constituents
 - By the 5th of the following month;
 - Review of the outage data by RLDC / constituents and forward the same to respective RPC – by 20th of the month;
 - Issue of availability certificate by respective RPC by the 3rd of the next month.

Central Transmission Utility of India Limited

229

Bikaner A Power Transmission Limited

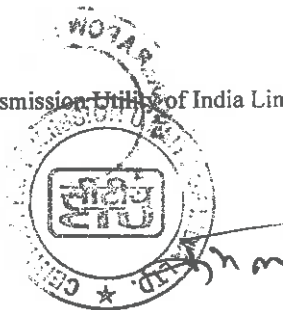

294

Appendix-V

FORMULAE FOR CALCULATION OF AVAILABILITY OF EACH CATEGORY OF TRANSMISSION ELEMENTS

For AC transmission system

$$AV_o(\text{Availability of } o \text{ no. of AC lines}) = \frac{\sum_{k=1}^o W_k(T_k - T_{NAk})T_k}{\sum_{k=1}^o W_k}$$

$$AV_q(\text{Availability of } q \text{ no. of ICTs}) = \frac{\sum_{k=1}^q W_k(T_k - T_{NAk})T_k}{\sum_{k=1}^q W_k}$$

$$AV_r(\text{Availability of } r \text{ no. of SVCs}) = \frac{\sum_{k=1}^{r-1} W_k(T_k - T_{NAk})T_k}{\sum_{k=1}^r W_k}$$

$$AV_p(\text{Availability of } p \text{ no. of Switched Bus reactors}) = \frac{\sum_{m=1}^p W_m(T_m - T_{NA m})T_m}{\sum_{m=1}^p W_m}$$

$$AV_u(\text{Availability of } u \text{ no. of STATCOMs}) = \frac{\sum_{n=1}^u W_n(T_n - T_{NA n})T_n}{\sum_{n=1}^u W_n}$$

$$AV_{xp}(\text{Availability of an individual HVDC pole}) = \frac{(T_x - T_N)}{T_x}$$

AV_{yob} (Availability of an individual HVDC

$$\text{Back-to-back Blocks}) = \frac{(T_y - T_{NAy})}{T_y}$$

Central Transmission Utility of India Limited

230

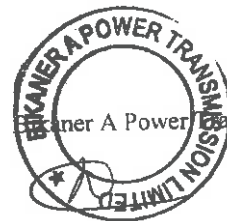

Bikaner A Power Transmission Limited



295

For the HVDC transmission system

For the new HVDC commissioned but not completed twelve months:

For first 12 months: $[(AV_{xop} \text{ or } AV_{yob}) \times 95\%/85\%]$, subject to a ceiling of 95%.

Where.

- o = Total number of AC lines;
- AV_o = Availability of o number of AC lines;
- p = Total number of bus reactors/switchable line reactors;
- AV_p = Availability of p number of bus reactors/switchable line reactors;
- q = Total number of ICTs;
- AV_q = Availability of q number of ICTs;
- r = Total number of SVCs;
- AV_r = Availability of r number of SVCs;
- U = Total number of STATCOM;
- AV_u = Availability of u number of STATCOMs;
- W_i = Weightage factor for i th transmission line;
- W_k = Weightage factor for k th ICT;
- W_l = Weightage factors for inductive & capacitive operation of l th SVC;
- W_m = Weightage factor for m th bus reactor.
- W_n = Weightage factor for n th STATCOM.
- T_i, T_k, T_l = The total hours of i th AC line, k th ICT, l th SVC, m th Switched Bus Reactor & n th STATCOM, x th HVDC pole, y th HVDC back-to-back blocks during the period under consideration (excluding time period for outages not attributed to transmission licensee for the reasons given in Para 5 of the procedure)
- T_{nai}, T_{nak} = The non-availability hours (excluding the time period for outages not attributable to transmission licensee taken as deemed availability as $T_{nai}, T_{nam}, T_{nal}, T_{nan}, T_{nax}, T_{nay}$ per Para 5 of the procedure) for i th AC line, k th ICT, l th SVC, m th Switched Bus Reactor, n th STATCOM, x th HVDC pole and y th HVDC back-to-back block.

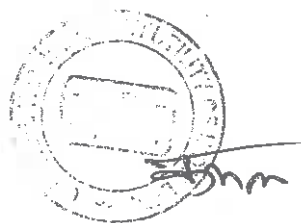

Schedule: 7

Entire Bid (both financial bid and technical bid) of the Selected Bidder to be attached here

Bid dated 26.09.2024 shall be integral part of this agreement.

Central Transmission Utility of India Limited

232

Bikaner Power Transmission Limited



297

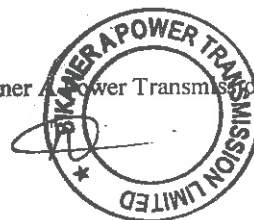

Schedule: 8

Contract Performance Guarantee

(To be on non-judicial stamp paper of appropriate value as per Stamp Act relevant to place of execution. Foreign entities submitting Bids are required to follow the applicable law in their country.)

In consideration of the[Insert name of the SPV or Selected Bidder on behalf of the TSP, or Lead Member in case of the Consortium, with address] agreeing to undertake the obligations under the Transmission Service Agreement datedand the other RFP Project Documents and the Nodal Agency and the[Insert the name of the BPC], agreeing to execute the RFP Project Documents with the Selected Bidder, regarding setting up the Project, the [Insert name and address of the bank issuing the guarantee and address of the head office] (hereinafter referred to as "Guarantor Bank") hereby agrees unequivocally, irrevocably and unconditionally to pay to (being the Nodal Agency) at[Insert the Place from the address of the Nodal Agency indicated in the TSA] forthwith on demand in writing from the Nodal Agency or any Officer authorized by it in this behalf, any amount up to and not exceeding Rupees Crores (Rs.) only [Insert the amount of the bank guarantee] on behalf of M/s. [Insert name of the Selected Bidder or SPV].

This guarantee shall be valid and binding on the Guarantor Bank up to and includingand shall not be terminable by notice or any change in the constitution of the Bank or the term of the Transmission Service Agreement or by any other reasons whatsoever and our liability hereunder shall not be impaired or discharged by any extension of time or variations or alternations made, given, or agreed with or without our knowledge or consent, by or between parties to the respective agreement.

Our liability under this Guarantee is restricted to Rs. Crores (Rs.) only. Our Guarantee shall remain in force until [Insert the date of validity of the Guarantee as per Article 3.1.2 of this Agreement]. The Nodal Agency, shall be entitled to invoke this Guarantee up to three hundred sixty five (365) days of the last date of the validity of this Guarantee.

Central Transmission Utility of India Limited

233

Bikaner Power Transmission Limited

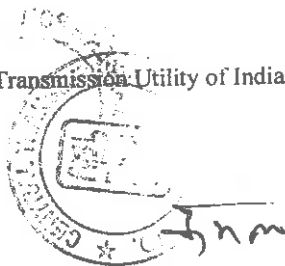

298

The Guarantor Bank hereby expressly agrees that it shall not require any proof in addition to the written demand from (in its roles as the Nodal Agency), made in any format, raised at the above mentioned address of the Guarantor Bank, in order to make the said payment to Nodal Agency.

The Guarantor Bank shall make payment hereunder on first demand without restriction or conditions and notwithstanding any objection by [Insert name of the Selected Bidder], [Insert name of the TSP] and / or any other person. The Guarantor Bank shall not require Nodal Agency to justify the invocation of this BANK GUARANTEE, nor shall the Guarantor Bank have any recourse against Nodal Agency in respect of any payment made hereunder.

THIS BANK GUARANTEE shall be interpreted in accordance with the laws of India.

The Guarantor Bank represents that this BANK GUARANTEE has been established in such form and with such content that it is fully enforceable in accordance with its terms as against the Guarantor Bank in the manner provided herein.

THIS BANK GUARANTEE shall not be affected in any manner by reason of merger, amalgamation, restructuring, liquidation, winding up, dissolution or any other change in the constitution of the Guarantor Bank.

THIS BANK GUARANTEE shall be a primary obligation of the Guarantor Bank and accordingly Nodal Agency shall not be obliged before enforcing this BANK GUARANTEE to take any action in any court or arbitral proceedings against [Insert name of the SPV] or the Selected Bidder, as the case may be, to make any claim against or any demand on [Insert name of the SPV] or the Selected Bidder, as the case may be, or to give any notice to [Insert name of the SPV] or the Selected Bidder, as the case may be, or to enforce any security held by the Nodal Agency or to exercise, levy or enforce any distress, diligence or other process against [Insert name of the SPV] or the Selected Bidder, as the case may be.

The Guarantor Bank acknowledges that this BANK GUARANTEE is not personal to Nodal Agency and may be assigned, in whole or in part, (whether absolutely or by way of security) by Nodal Agency to any entity to whom the Nodal Agency is entitled to assign its rights and obligations under the Transmission Service Agreement.

The Guarantor Bank hereby agrees and acknowledges that Nodal Agency shall have a right to invoke this Bank Guarantee either in part or in full, as it may deem fit.

Notwithstanding anything contained hereinabove, our liability under this Guarantee is restricted to Rs. Crores (Rs.) only and it shall remain in force until Date to be inserted on the basis of Article

Central Transmission Utility of India Limited

234 Bikaner Power Transmission Limited

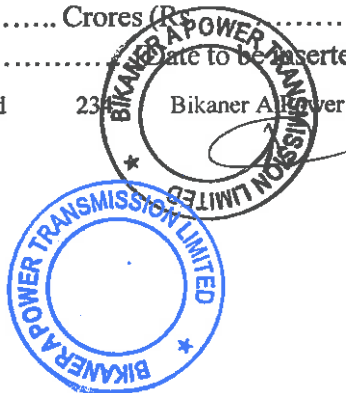
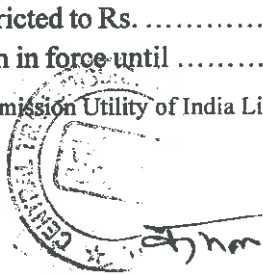

3.1.2 of the Transmission Service Agreement], with an additional claim period of three hundred sixty five (365) days thereafter. This BANK GUARANTEE shall be extended from time to time for such period, as may be desired by [Insert name of the Selected Bidder or Lead Member in case of the Consortium or SPV]. We are liable to pay the guaranteed amount or any part thereof under this Bank Guarantee only if Nodal Agency serves upon us a written claim or demand.

In witness where of:

Signature

Name:

Power of attorney No.:

For:

..... [Insert Name of the Bank]

Banker's Seal and Full Address, including mailing address of the Head Office

Central Transmission Utility of India Limited

235

Bikaner A Power Transmission Limited

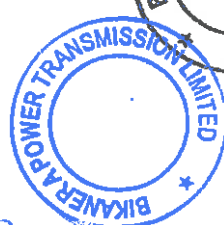
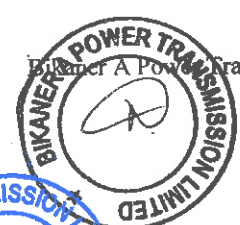
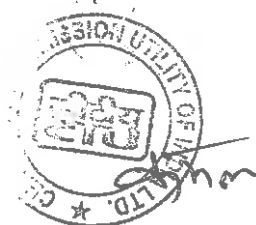

800

Schedule: 9

Methodology for determining the Relief Under Force Majeure Event & Change in Law during Construction Period

The relief in the form of revision in tariff due to Force Majeure Event leading to extension of Scheduled COD for a period beyond one hundred eighty (180) days and/ or Change in Law during the construction period shall be as under:

$$\Delta T = [(P \times d)] \div [1 - (1 + d)^{-n}]$$

Where,

ΔT = Change in Transmission Charges for each year

P = Sum of cumulative increase or decrease in the cost of the Project due to Change in Law and interest cost during construction corresponding to the period exceeding one hundred eighty (180) due to Force Majeure Event leading to extension of Scheduled COD for a period beyond one hundred eighty (180) days

n = number of years over which the Transmission Charges has to be paid

d = Discount rate as notified by the CERC, applicable on the Bid Deadline

The increase in Transmission Charges as stated above shall be applicable only if the value of increase in Transmission Charges as calculated above exceeds 0.30% (zero point three percent) of the quoted Transmission Charges of the TSP.

Central Transmission Utility of India Limited

236

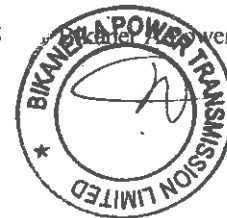

Bikaner Power Transmission Limited



301

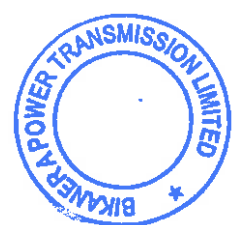

Ref No. RECPDCL/TBCB/Raj Ph-IV (Part-3 6 GW):Part -A:2024 25/11/24 Date 02/08/2024

Mr. Pankaj Pandey, ED
M/s Power Grid Corporation of India Limited
Saudamini, Plot no. 2, Sector-29
Gurgaon-122001(Haryana)

Subject: Selection of Bidder as Transmission Service Provider (TSP) to establish "Transmission system for evacuation of power from Rajasthan REZ Ph-IV (Part-3: 6GW) [Bikaner complex]: Part-A" to be implemented through Tariff Based Competitive Bidding process - Issuance of Tentative Acquisition Price regarding.

Dear Sir,

This has reference to the RFP dated 06.06.2024 for selection of Transmission Service Provider to establish transmission System for "Transmission scheme for Rajasthan REZ Ph-IV (Part-3: 6GW) [Bikaner complex]: Part-A" (hereinafter referred to as "the Project") through tariff based competitive bidding process.

As per the requirement of Clause 1.5 of RFP, we would like to intimate you that the Tentative Acquisition Price payable by the Selected Bidder to the BPC for the acquisition of one hundred percent (100%) of the equity shareholding of **BIKANER A POWER TRANSMISSION LIMITED**, along with all its related assets and liabilities is **Rs. 1839.89 Lakhs** (Rupees Eighteen Crore Thirty-Nine Lakh Eighty-Nine Thousand only). This Acquisition Price shall be subject to adjustment based on the audited accounts of **BIKANER A POWER TRANSMISSION LIMITED** as on the date of execution of the Share Purchase Agreement.

As per clause no. 3.5 of revised guidelines issued vide Gazette Notification dated 10.08.2021 for BPC (Bid Process Coordinator), price variation between Tentative Acquisition Price and the amount to be paid finally at the end of bidding process by selected bidder should not be more than 5%.

It is further to inform that "Change in Law" would not be applicable on account of Tentative Acquisition Price variation within above mentioned limit

It may please be noted that as on date, there are no contractual obligations undertaken by BPC on behalf of **BIKANER A POWER TRANSMISSION LIMITED** which are to be fulfilled by the TSP.

All other terms and conditions of the RFP remain the same.

Thanking you,

Yours faithfully,

Satyaban Sahoo
(Satyaban Sahoo) 02/08/24
General Manager (Tech)

ATTESTED TRUE COPY
Attested from pg 302 - pg 304
Authorised Signatory
BIKANER A POWER TRANSMISSION LIMITED

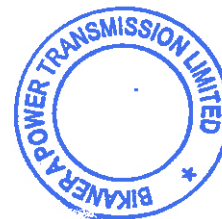

302

Ref No.: REC/PDCL/Fin/BAPTI/2021-25/2677

Dated: 07.11.2021

To,

M/s. Power Grid Corporation of India Limited

'Saudamini' Plot no.-2, Sector-29

Gurugram - 122001, Haryana

Kind Attention Mr. Pankaj Pandey (ED)

Subject: Payment of Acquisition Price towards handing over of M/s. BIKANER A POWER TRANSMISSION LIMITED.

Sir,

This is to inform that the acquisition price of M/s. BIKANER A POWER TRANSMISSION LIMITED is Rs. 18,46,75,509/- (Rupees Eighteen Crore Forty-Six Lakh Seventy-Five Thousand Five Hundred Nine Only) as per the breakup given below

S No	Particulars	Amount (INR)
1	Professional Fee of BPC #	17,70,00,000
2	Reimbursement of cost incurred by BPC	71,75,509
3	Share Capital of Bikaner A Power Transmission Limited	5,00,000
Acquisition Value/ Net Amount Payable by Bidder		18,46,75,509

including GST

Kindly credit the above total amount i.e., Rs. 18,46,75,509/- in the below mentioned Bank Account of REC Power Development and Consultancy Limited. TDS will be deposited by RECPDCL on behalf and under TAN of Bikaner A Power Transmission Limited.



[Handwritten Signature]

303

The acquisition price may be credited to our account through RTGS as per the following:

Bank Name, Address & Branch	IDFC First Bank Limited Gurgaon Golf Course Road Branch, Ground Floor Unit no. CG-01A and 01B, Gurgaon - 122003
Bank Account Name	REC Power Development and Consultancy Ltd
Bank Account No	10171707713
Bank IFSC Code No	IDFB0021001

Thanking You.

Yours faithfully

(Ch V Lakshmana Charyulu)
HoD (P&A)



SHARE PURCHASE AGREEMENT

BETWEEN

REC POWER DEVELOPMENT AND CONSULTANCY LIMITED

AND

BIKANER A POWER TRANSMISSION LIMITED

AND

POWER GRID CORPORATION OF INDIA LIMITED

Dated: 11th November, 2024

ATTESTED TRUE COPY
Attested from 19 305 to 324
Authorised Signatory
BIKANER A POWER TRANSMISSION LIMITED



805

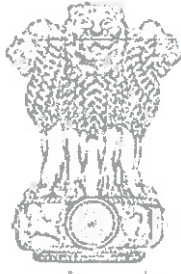

सत्यमेव जयते

INDIA NON JUDICIAL

Government of National Capital Territory of Delhi

e-Stamp
Reprinted e-Stamp Certificate

Certificate No. : IN-DL83911932176474W
Certificate Issued Date : 09-Nov-2024 01:52 PM
Account Reference : SELFPRINT (PU)/ dl-self/ NEHRU/ DL-DLH
Unique Doc. Reference : SUBIN-DLTL-SELF16396361443859W
Purchased by : REC POWER DEVELOPMENT AND CONSULTANCY
Description of Document : Article 5 General Agreement
Property Description : CORE-4,SCOPE COMPLEX, 7, LODHI ROAD, NEW DELHI-110003
Consideration Price (Rs.) : 0 (Zero)
First Party : BIKANER A POWER TRANSMISSION LIMITED
Second Party : POWER GRID CORPORATION OF INDIA LIMITED
Stamp Duty Paid By : BIKANER A POWER TRANSMISSION LIMITED
Stamp Duty Amount(Rs.) : 500 (Five Hundred only)

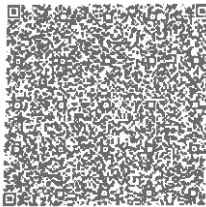

SELF PRINTED CERTIFICATE TO BE VERIFIED BY THE RECIPIENT AT WWW.SHCILESTAMP.COM



SHARE PURCHASE AGREEMENT

This SHARE PURCHASE AGREEMENT ('Agreement') made on the 11th day of November, 2024 at New Delhi by and between:

REC POWER DEVELOPMENT AND CONSULTANCY LIMITED, a company incorporated under the Companies Act, 1956, vide CIN-U40101DL2007GOI165779 having its registered office at Core 4, SCOPE Complex, 7, Lodhi Road, New Delhi 110 003, India (hereinafter referred to as "REC PDCL", which expression shall, unless it be repugnant to the context or meaning thereof, be deemed to mean and include its successors and permitted...

Signature of REC PDCL representative

Signature of Bikaner A Power Transmission Limited representative



306

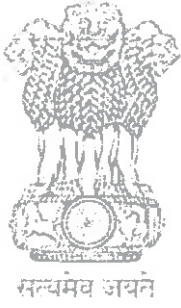

INDIA NON JUDICIAL

Government of National Capital Territory of Delhi

e-Stamp

Certificate No : IN-DL83282740478239W
Certificate Issued Date : 08-Nov-2024 03:06 PM
Account Reference : SELFPRINT (PU)/ dl-self/ NEHRU/ DL-DLH
Unique Doc. Reference : SUBIN-DL.DL-SELF15256675370362W
Purchased by : REC POWER DEVELOPMENT AND CONSULTANCY
Description of Document : Article 5 General Agreement
Property Description : CORE-4.SCOPE COMPLEX. 7, LODHI ROAD, NEW DELHI-110003
Consideration Price (Rs.) : 0
(Zero)
First Party : BIKANER A POWER TRANSMISSION LIMITED
Second Party : POWER GRID CORPORATION OF INDIA LIMITED
Stamp Duty Paid By : BIKANER A POWER TRANSMISSION LIMITED
Stamp Duty Amount(Rs.) : 500
(Five Hundred only)

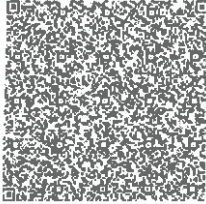

SELF PRINTED CERTIFICATE TO BE
VERIFIED BY THE RECIPIENT AT
WWW.SHCILESTAMP.COM



AND

BIKANER A POWER TRANSMISSION LIMITED a company incorporated under the Companies Act, 2013 vide CIN - U42202DL2024GOI431226, having its registered office at Core 4, SCOPE Complex, 7, Lodhi Road, New Delhi 110003, India (herein after referred to as "**Company**") which expression shall, unless repugnant to the context, mean and include its successors in interest) of the
SECOND PART;

RECPDCL

New Delhi
110003
Bikaner A Power Transmission Limited
Scope Complex, 7, Lodhi Road

POWER GRID CORPORATION OF INDIA LTD.
भारतीय पावरग्रिड

307

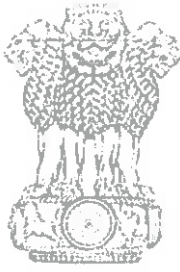

सत्यमेव जयते

INDIA NON JUDICIAL

Government of National Capital Territory of Delhi

e-Stamp

Certificate No. : IN-DL83278722168828W
 Certificate Issued Date : 08-Nov-2024 03:03 PM
 Account Reference : SELFPRINT (PU)/ dl-self/ NEHRU/ DL-DLH
 Unique Doc. Reference : SUBIN-DL DL-SELF15246628492175W
 Purchased by : REC POWER DEVELOPMENT AND CONSULTANCY
 Description of Document : Article 5 General Agreement
 Property Description : CORE-4,SCOPE COMPLEX, 7, LODHI ROAD, NEW DELHI-110003
 Consideration Price (Rs.) : 0
 (Zero)
 First Party : BIKANER A POWER TRANSMISSION LIMITED
 Second Party : POWER GRID CORPORATION OF INDIA LIMITED
 Stamp Duty Paid By : BIKANER A POWER TRANSMISSION LIMITED
 Stamp Duty Amount(Rs.) : 200
 (Two Hundred only)

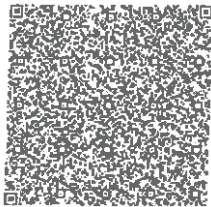

SELF PRINTED CERTIFICATE TO BE VERIFIED BY THE RECIPIENT AT WWW.SHCILESTAMP.COM

AND

POWER GRID CORPORATION OF INDIA LIMITED, a company incorporated under the Companies Act, 1956 vide CIN-L40101DL1989GOI038121 and having its registered office at B-9, Qutab Institutional Area, Katwaria Sarai, New Delhi-110016 (hereinafter referred to as "Selected Bidder" which expression shall, unless repugnant to the context or meaning thereof be deemed to mean and include its successors and permitted assignees) of the

RECPDCL

New Delhi 110003
Bikaner A PTL
Scope Complex, 7, Lodhi

BIKANER A POWER TRANSMISSION LIMITED

POWER GRID CORPORATION OF INDIA LTD.
OFFICE OF THE CHIEF EXECUTIVE OFFICER
POWER GRID CORPORATION OF INDIA LTD.

308

WHEREAS:

- A The Ministry of Power, Government of India, vide its notification no. 1298 [F No. 15/3/2018-Trans-Pt(4)] dated 15.03.2024 has appointed REC Power Development and Consultancy Limited to be the Bid Process Coordinator (BPC) for the purpose of selection of Bidder as Transmission Service Provider (TSP) to establish "Transmission system for evacuation of power from Rajasthan REZ Ph-IV (Part-3: 6 GW) [Bikaner complex] : Part A" through tariff based competitive bidding process (hereinafter referred to as the "Project").
- B In accordance with the Bidding Guidelines, the BPC had initiated a competitive bidding process through issue of RFP for selecting a Successful Bidder to build, own, operate and transfer the Project comprising of the Elements mentioned in **Schedule 2** of the TSA. BPC had initiated this process in accordance with and on the terms and conditions mentioned in the RFP Project Documents (as defined hereinafter).
- C BPC has incorporated the Company and has undertaken the preliminary studies, obtained certain approvals, etc regarding the Project on behalf of the Company
- D REC PDCL along with the Nominees hold one hundred per cent (100%) of the total issued and paid up equity share capital of the Company.
- E Pursuant to the said Bid Process, Power Grid Corporation of India Limited has been identified as the Selected Bidder vide Letter of Intent dated 21st October 2024 issued by the BPC in favour of the Selected Bidder.
- F As envisaged in the RFP, the Shares Seller (as defined hereinafter) has agreed to sell the Sale Shares (as defined hereinafter) to the Selected Bidder and the Selected Bidder has agreed to purchase the Sale Shares from the Shares Seller, subject to and on the terms and conditions set forth in this Agreement.

NOW THEREFORE, IN CONSIDERATION OF THE MUTUAL COVENANTS AND AGREEMENTS SET FORTH IN THIS AGREEMENT AND FOR OTHER GOOD AND VALUABLE CONSIDERATION, THE PARTIES HEREBY AGREE AS FOLLOWS:

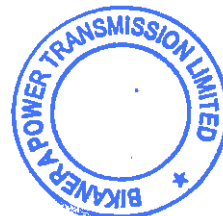
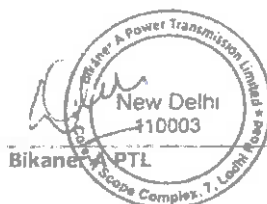

1. DEFINITIONS

- 1.1 Capitalized terms in this Agreement, unless defined in this Agreement shall, in so far as the context admits, have the same meaning in this Agreement as has been ascribed to them in the TSA
- 1.2 Additionally, the following terms shall have the meaning hereinafter respectively assigned to them herein below:
- (i) **"Acquisition Price"** shall mean INR 18,46,75,509/- (Rupees Eighteen Crore Forty-Six Lakh Seventy-Five Thousand Five Hundred Nine Only), which is the aggregate consideration payable by the Selected Bidder towards purchase of the Sale Shares at par and for taking over of all assets and liabilities of the Company as on the Closing Date subject to adjustment as per the audited accounts of the Company as on the Closing Date;
 - (ii) **"Agreement"** or **"the Agreement"** or **"this Agreement"** shall mean this Share Purchase Agreement and shall include the recitals and/or annexures attached hereto, and the contracts, certificates, disclosures and other documents to be executed and delivered pursuant hereto, if any, and any amendments made to this Agreement by the Parties in writing;
 - (iii) **"Bid Process"** shall mean the competitive bidding process initiated by the BPC, by issuance of RFP for selecting a Successful Bidder to build, own, operate and transfer the Project in accordance with and on the terms and conditions mentioned in the RFP Project Documents;
 - (iv) **"Board"** shall mean the board of directors of the Company.
 - (v) **"Closing Date"** shall mean a mutually agreed date between the Parties falling within the period as mentioned in clause 2.15.2 of RFP or on failure of such mutual agreement between the Parties shall be the date falling on the last date of such period;
 - (vi) **"Encumbrance"** shall mean any mortgage, pledge, lien, charge, security assignment, hypothecation, trust, encumbrance or any other agreement having the effect of creating security interest;
 - (vii) **"Letter of Intent"** shall have the meaning ascribed thereto under the Bid Documents;
 - (viii) **"Nominees"** shall mean the Persons, who are named in Annexure A of this Agreement, holding the Sale Shares as nominees of REC PDCL:

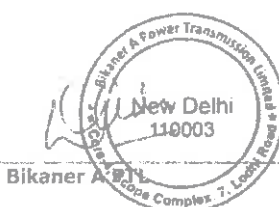

- (ix) "Party" shall mean REC PDCL, Company and the Selected Bidder referred to individually, and "Parties" shall mean REC PDCL, Company and the Selected Bidder collectively referred to, as relevant;
- (x) "Person" shall include an individual, an association, a corporation, a partnership, a joint venture, a trust, an unincorporated organisation, a joint stock company or other entity or organisation, including a government or political subdivision, or an agency or instrumentality thereof, and/or any other legal entity;
- (xi) "RFP Project Documents" shall mean the following documents, referred to collectively:
- Transmission Service Agreement; and
 - this Agreement.
- (xii) "Representations and Warranties" shall mean the representations and warranties mentioned in Clause 4 hereto;
- (xiii) "RoC" shall mean the Registrar of Companies;
- (xiv) "Sale Shares" shall mean 50,000 shares, representing one hundred percent (100%) of the total issued, subscribed and fully paid-up equity share capital of the Company held by the Shares Seller and Nominees as more particularly described in Annexure A attached hereto;
- (xv) "Shares" shall mean the fully paid-up equity shares of Company, of face value Rs. 10 each;
- (xvi) "Shares Seller" shall mean REC PDCL; and
- (xvii) "Transmission Service Agreement" or "TSA" means the agreement titled 'Transmission Service Agreement' to be executed on 11th November, 2024 between Central Transmission Utility of India Limited (CTUIL) and Bikaner A Power Transmission Limited, pursuant to which the TSP shall build, own, operate and transfer the Project and make available the assets of the Project on a commercial basis.

1.3 Interpretation Clause

Unless the context otherwise requires, the provisions of the TSA relating to the interpretation of the TSA shall apply to this Agreement as if they were set out in full in this Agreement and to this end are incorporated herein by reference.

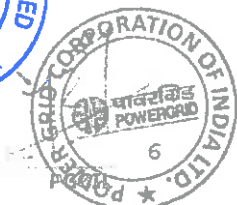
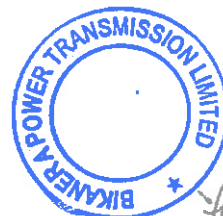

2. TRANSFER OF SHARES

- 2.1 Subject to the terms and conditions of this Agreement, the Shares Seller agrees to sell and transfer to the Selected Bidder and the Selected Bidder hereby agrees to purchase from the Shares Seller, the Sale Shares free from Encumbrances together with all assets and liabilities of the Company with rights and benefits attached thereto in consideration of the Acquisition Price and the covenants, undertakings and the agreements of the Selected Bidder contained in this Agreement.
- 2.2 The Shares Seller hereby undertakes to cause the Nominees to transfer part of the Sale Shares held by them as nominees of the Shares Seller to the Nominees of Selected Bidder and execute any documents required to deliver good title to the Sale Shares to the Selected Bidder

3. CLOSING

- 3.1 Prior to the Closing Date, the Selected Bidder shall provide to the Shares Seller, valid share transfer forms duly stamped with requisite amount of stamp duty payable on the transfer of the Sale Shares ("**Share Transfer Forms**")
- 3.2 On the Closing Date, the Shares Seller shall hand over to the Selected Bidder or its authorised representative, the original share certificates representing the Sale Shares ("**Sale Share Certificates**") executed by the Shares Seller and the Nominees, simultaneously against the Selected Bidder handing over to the Shares Seller, demand drafts drawn in favour of the Shares Seller or by confirmation of RTGS transfer in favour of the Shares Seller, for the Acquisition Price payable to it.

Provided that prior to the handing over of the Sale Share Certificates to the Selected Bidder as mentioned above, the Selected Bidder shall provide satisfactory evidence to REC PDCL that on the Closing Date, the Selected Bidder has furnished the Contract Performance Guarantee to Central Transmission Utility of India Limited (CTUIL) and is in a position to comply with all other requirements of Clause 2.15.2 of the RFP

- 3.3 The Selected Bidder shall immediately upon receiving the Sale Share Certificates and the Share Transfer Forms, duly execute the Share Transfer Forms and duly lodge the Share Transfer Forms and the Share Certificates with the Company along with the names of its nominees to be appointed on the Board of the Company and the address within the jurisdiction of the Registrar of Companies of New Delhi and Haryana, which would be the new registered office of the Company. The Company shall, upon receipt of the said documents from the Selected Bidder, do the following.

- (i) Immediately on the Closing Date convene a meeting of the Board, wherein the Board shall pass the following necessary resolutions:

RECPDCL



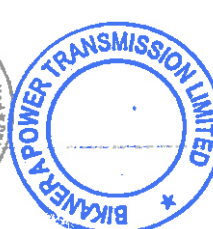

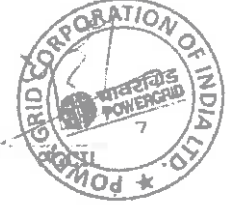

- (a) approving the transfer of the Shares constituting the Sale Shares from the Shares Seller and the Nominees to the name of the **Power Grid Corporation of India Limited** and its nominees and transfer of all assets and liabilities of the Company as on Closing Date;
- (b) approving the **Power Grid Corporation of India Limited** and its nominees as the members of the Company and entering the name of the **Power Grid Corporation of India Limited** and its nominees in the register of members.
- (c) changing the address of the registered office of the Company to the new address as provided by the Selected Bidder as per clause 3.3 above
- (d) appointing the nominees of the Selected Bidder on the Board and accepting the resignations of the other existing Directors on the Board and the Chair of the meeting which was taken by one of the existing Directors shall be vacated and appointment of a new Chairman who shall be one of the newly appointed Director, for the rest of the meeting.

Immediately pursuant to the acceptance of resignation of the existing Directors and appointment of new Chairman, the newly constituted Board of Directors shall continue with the meeting and pass the following resolution:

- (e) terminating all the authorizations granted regarding the business and/or operations of the Company or the operations of the bank accounts of the Company, with prospective effect; and
 - (f) acknowledging and accepting the terms and conditions as contained in the executed copies of the RFP Project Documents and to abide by the provisions contained therein.
- (ii) Enter the name of the **Power Grid Corporation of India Limited** and its nominees as the legal and beneficial owner of the Sale Shares, free of all Encumbrances, in the register of members of the Company;
 - (iii) Make the necessary endorsements on the Sale Share Certificates, indicating the name of the **Power Grid Corporation of India Limited** and its nominees as the legal and beneficial owner of the Sale Shares evidenced there under;
 - (iv) Return the original Sale Share Certificates, duly endorsed in the name of the **Power Grid Corporation of India Limited** and its nominees, to the **Power Grid Corporation of India Limited** and its nominees as the case may be or its authorized representative;

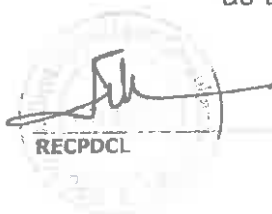

313

- (v) Handover all the statutory registers and records if any of the Company to the Selected Bidder.
- (vi) Handover certified true copies of the Board resolution passed by the Company as per (i) (a) to (i) (f) of Clause 3.3 (i) to the Central Transmission Utility of India Limited (CTUIL).

3.4 The Parties to this Agreement agree to take all measures that may be required to ensure that all the events contemplated in the **Clauses 3.1 to 3.3** above on the Closing Date are completed on the same day.

Notwithstanding the provisions of **Clause 3.3** hereto, all proceedings to be taken and all documents to be executed and delivered by the Parties at the Closing Date shall be deemed to have been taken and executed simultaneously and no proceedings shall be deemed to have been taken nor documents executed or delivered until all have been taken, executed and delivered.

3.5 The Selected Bidder hereby acknowledges and agrees that after the date of acquisition of one hundred percent (100%) of the Shares of the Company by the Selected Bidder as per Clause 3.3, (a) the authority of the BPC in respect of the Bid Process shall forthwith cease and any actions to be taken thereafter regarding the Bid Process will be undertaken by the Central Transmission Utility of India Limited (CTUIL) themselves, (b) all rights and obligations of the BPC shall cease forthwith, (c) all other rights and obligations of the Company shall be of the TSP and (d) any decisions taken by the BPC on behalf of the Company prior to the date of acquisition shall continue to be binding on the Company and/or Central Transmission Utility of India Limited (CTUIL) as the case may be.

3.6 This Agreement shall be effective from the date of its signing by the Parties and shall remain in force until all the obligations of the respective Parties under Clause 3.3 hereto are fulfilled.

4. REPRESENTATIONS AND WARRANTIES

4.1 The Selected Bidder hereby represents and warrants to the Shares Seller that:

4.1.1 The Selected Bidder has full legal right, power and authority to enter into, execute and deliver this Agreement and to perform the obligations, undertakings and transactions set forth herein, and this Agreement has been duly and validly executed and delivered by the Selected Bidder and constitutes its legal, valid and binding obligations, enforceable against it in accordance with its terms.

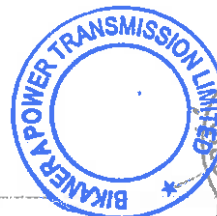

- 4.1.2 The execution, delivery and performance of this Agreement by the Selected Bidder will not violate or contravene any provision of the Memorandum of Association or Articles of the Selected Bidder, (ii) will not violate or contravene any law, statute, rule, regulation, licensing requirement, order, writ, injunction or decree of any court, governmental instrumentality or other regulatory, governmental or public body, agency or authority by which the Selected Bidder is bound or by which any of its and/or their properties or assets are bound, and (iii) except to the extent that the same have been duly and properly completed or obtained, will not require any filing with, or permit, consent or approval of or license from, or the giving of any notice to, any court, governmental instrumentality or other regulatory, governmental or public body, agency or authority, joint venture party, or any other entity or person whatsoever; and
- 4.1.3 The Selected Bidder is not restricted in any manner whatsoever, including without limitation, on account of any judicial or governmental order, action or proceeding, or any contractual obligation assumed by the Selected Bidder, from purchasing the Sale Shares from the Shares Seller in the manner provided for in this Agreement.
- 4.2 The Shares Seller hereby represents and warrants to the Selected Bidder that:
- 4.2.1 The Shares Seller and the Nominees are the legal and beneficial owners of the Sale Shares, free and clear of any Encumbrance and the delivery to the Selected Bidder of the Sale Shares pursuant to the provisions of this Agreement will transfer to the Selected Bidder a good title to the Sale Shares.
- 4.2.2 The Shares Seller has full legal right, power and authority to enter into, execute and deliver this Agreement and to perform the obligations, undertakings and transactions set forth herein. The execution, delivery and performance of this Agreement will not violate the Memorandum and Articles of Association of the Shares Seller or contravene any contract by which it is bound.
- 4.2.3 The Shares Seller has obtained requisite authorizations to sell and transfer the Sale Shares to the Selected Bidder. The Shares Seller also represent that it is not prevented from transferring and selling the Sale Shares. Also, to the best of its knowledge, the Sale Shares are not the subject matter of any claim or pending proceeding or threatened by any legal proceeding made by any third party.
- 4.3 Except as specified in Clause 4.2 above, the Shares Seller shall not be deemed to have, made any representation or warranty whatsoever, whether express or implied, in relation to the Sale Shares or Company, including but not limited to any implied warranty or representation as to the business or affairs of Company.

RECPDCL

Bikaner PTL
Scope Complex, 7, Lodi Road

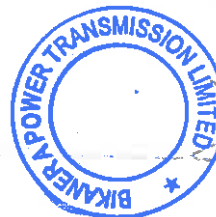
BIKANER A POWER TRANSMISSION LIMITED

POWER GRID CORPORATION OF INDIA LTD.
पावरग्रिड कोर्पोरेशन ऑफ इंडिया लि.
10

- 4.4 The Representations and Warranties are given as at the date of this Agreement except that where a Representation and Warranty is expressed to be made as at another date, the Representation and Warranty is given with respect to that date only.
- 4.5 Each Representation and Warranty is to be construed independently of the others and is not limited by reference to any other Warranty. The Representations, Warranties and undertakings contained in this **Clause 4** hereto or in any document delivered pursuant to or in connection with this Agreement are continuing in nature and shall survive the Closing Date for a period of one (1) year.
- 4.6 The Parties represent to each other that all Representations and Warranties provided herein by the respective Party shall be true as of Closing Date.

5. OBLIGATIONS OF THE SELECTED BIDDER

The Selected Bidder agrees that the Shares Seller shall not be liable in any manner, nor shall it assume any responsibility or liability whatsoever, in respect of the business of the Company and its operations or activities, arising after the Closing Date, to any Person or any authority, central, state, local or municipal or otherwise and the same shall be the sole responsibility of the Selected Bidder.

6. MISCELLANEOUS

6.1 NOTICES

- a) All notices to be given under this Agreement shall be in writing and in the English language.
- b) All notices must be delivered personally or by registered or certified mail or by recognised courier to the addresses below.

Selected Bidder: **Power Grid Corporation of India Limited,**
B-9, Qutab Institutional Area, Katwaria Sarai
New Delhi-110016

REC PDCL. **REC Power Development and Consultancy Limited**
Core-4, SCOPE Complex, 7, Lodhi Road, New
Delhi-110003

Company: **Bikaner A Power Transmission Limited**
Core-4, SCOPE Complex, 7, Lodhi Road, New
Delhi-110003

- c) Any Party may by notice of at least fifteen (15) days to the other Parties change the address and / or addresses to which such notices and communications to it are to be delivered.



RECPDCL



6.2 RESOLUTION OF DISPUTES

- 6.2.1 If any dispute arises between the Parties, in connection with the validity, interpretation, implementation or alleged breach of any provision of this Agreement ("Dispute"), the disputing Parties hereto shall endeavor to settle such Dispute amicably. The attempt to bring about an amicable settlement shall be considered to have failed if not resolved within sixty (60) days from the date of the Dispute
- 6.2.2 If the Parties are unable to amicably settle the Dispute in accordance with Clause 6.2.1 within the period specified therein, any of the Parties shall be entitled to within thirty (30) days after expiry of the aforesaid period, refer the Dispute to the Chief Executive Officer/Director of REC PDCL and Chief Executive/ Managing Director of the Selected Bidder for resolution of the said Dispute. The attempt to bring about such resolution shall be considered to have failed if not resolved within thirty (30) days from the date of receipt of a written notification in this regard.
- 6.2.3 In the event the Dispute is not settled in accordance with Clause 6.2.2 above, any Party to the Dispute shall be entitled to serve a notice invoking this Clause and making a reference to a sole arbitrator. If the Parties to the Dispute cannot agree as to the appointment of the sole arbitrator within thirty (30) days of receipt of the notice of the Party making the reference, then the Shares Seller along with the Company shall appoint one arbitrator and the Selected Bidder shall appoint one arbitrator and the two arbitrators, so appointed shall appoint a third arbitrator. However, after the Closing Date, in such an event the Shares Seller shall appoint one arbitrator and the Selected Bidder along with the Company shall appoint one arbitrator and the two arbitrators, so appointed shall appoint the third arbitrator.
- 6.2.4 The place of the arbitration shall be New Delhi. The Arbitration proceedings shall be governed by the Arbitration and Conciliation Act, 1996.
- 6.2.5 The proceedings of arbitration shall be in English language
- 6.2.6 The arbitrator's award shall be substantiated in writing. The arbitrators shall also decide on the costs of the arbitration proceedings. In case the arbitrators have not decided on the costs of the arbitration proceedings, each Party to the Dispute shall bear its own costs, in relation to the arbitration proceedings.

RECPDCL

New Delhi
110003
Bikaner A Power Transmission Limited
Scope Complex, 7, Lohini Road

BIKANER A POWER TRANSMISSION LIMITED

POWER GRID CORPORATION OF INDIA LTD.
12
PGCIL

6.3 AUTHORISED PERSON

For the purposes of this Agreement, the Selected Bidder is represented by Shri Pankaj Pandey, ED (TBCB), Authorized Representative, pursuant to an authorization granted to Shri Pankaj Pandey, ED (TBCB) through necessary Board resolutions. Further, Shri Pankaj Pandey, ED (TBCB) is also authorized by such resolutions to take any decision which may be required to be taken, do all acts and execute all documents which are or may be required by the Selected Bidder for the proper and effective fulfillment of the rights and obligations under this Agreement. Any action taken or document executed by Shri Pankaj Pandey, ED (TBCB) shall be deemed to be acts done or documents executed by the Selected Bidder and shall be binding on the Selected Bidder.

6.4 RESERVATION OF RIGHTS

No forbearance, indulgence or relaxation or inaction by any Party at any time to require performance of any of the provisions of this Agreement shall in any way affect, diminish or prejudice the right of such Party to require performance of that provision, and any waiver or acquiescence by any Party of any breach of any of the provisions of this Agreement shall not be construed as a waiver or acquiescence of any continuing or succeeding breach of such provisions, a waiver of any right under or arising out of this Agreement or acquiescence to or recognition of rights other than that expressly stipulated in this Agreement.

6.5 CUMULATIVE RIGHTS

All remedies of either Party under this Agreement whether provided herein or conferred by statute, civil law, common law, custom or trade usage, are cumulative and not alternative and may be enforced successively or concurrently.

6.6 PARTIAL INVALIDITY

If any provision of this Agreement or the application thereof to any person or circumstance shall be invalid or unenforceable to any extent, the remainder of this Agreement and the application of such provision to persons or circumstances other than those as to which it is held invalid or unenforceable shall not be affected thereby, and each provision of this Agreement shall be valid and enforceable to the fullest extent permitted by law. Any invalid or unenforceable provision of this Agreement shall be replaced with a provision, which is valid and enforceable and most nearly reflects the original intent of the unenforceable provision.



RECPDCL

Bikaner A P

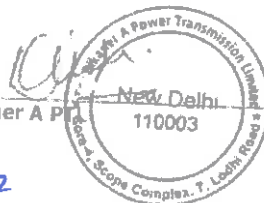

6.7 TERMINATION

If (i) the Closing does not occur on the Closing Date for any reason whatsoever, or (ii) the Letter of Intent is withdrawn or terminated for any reason, or (iii) due to termination of the TSA by the Central Transmission Utility of India Limited (CTUIL) in accordance with Article 3.3.2 or Article 13 of the TSA thereof, REC PDCL shall have a right to terminate this Agreement forthwith by giving a written notice to the other Parties hereto

6.8 AMENDMENTS

No modification or amendment of this Agreement and no waiver of any of the terms or conditions hereof shall be valid or binding unless made in writing and duly executed by all the Parties.

6.9 ASSIGNMENT

This Agreement and the rights and liabilities hereunder shall bind and inure to the benefit of the respective successors of the Parties hereto, but no Party hereto shall assign or transfer its rights and liabilities hereunder to any other Person without the prior written consent of the other Parties, which will not be unreasonably withheld.

6.10 ENTIRE AGREEMENT

This Agreement constitutes the entire Agreement between the Parties with respect to the subject matter herein and supersedes and cancels any prior oral or written agreement, representation, understanding, arrangement, communication or expression of intent relating to the subject matter of this Agreement.

6.11 COSTS

Each of the Parties hereto shall pay their own costs and expenses relating to the negotiation, preparation and execution of this Agreement and the transactions contemplated by this Agreement.

The Selected Bidder shall be liable to bear and pay the costs in respect of this Agreement and transfer of Sale Shares.

6.12 RELATIONSHIP

None of the provisions of this Agreement shall be deemed to constitute a partnership between the Parties hereto and no Party shall have any authority to bind the other Party otherwise than under this Agreement or shall be deemed to be the agent of the other in any way.

REC PDCL

Bikaner A
New Delhi
110003
Score Complex, T. Loahi Road

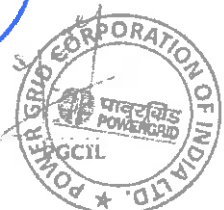

6.13 GOVERNING LAW AND JURISDICTION

This Agreement shall be governed by and construed in accordance with the laws of India and shall be subject to the exclusive jurisdiction of the courts of Delhi.

6.14 COUNTERPARTS

This Agreement may be executed in counterparts by the Parties and each fully executed counterpart shall be deemed to be original.

6.15 CONFIDENTIALITY

The Parties undertake to hold in confidence and not to disclose the terms and conditions of the transaction contemplated hereby to third parties, except:

- (a) to their professional advisors;
- (b) to their officers, employees, agents or representatives, who need to have access to such information for the proper performance of their activities;
- (c) disclosures required under Law;

without the prior written consent of the other Parties.

Provided that the Central Transmission Utility of India Limited (CTUIL) and REC PDCL may at any time, disclose the terms and conditions of transactions contemplated hereby to any person, to the extent stipulated under the law or the Bidding Guidelines.

6.16 INDEMNIFICATION

The Parties hereby agree that transfer of Sale Shares to the Selected Bidder shall vest all the rights, privileges, licenses, responsibilities, liabilities and other obligations pertaining to the Company in the Selected Bidder.

- The Selected Bidder hereby agrees that the Selected Bidder shall not be entitled to any claims or initiate any legal proceedings by itself or through the Transmission Service Provider against the Shares Seller, its directors, officers, employees and the subscribers including the members of any committees appointed by them in respect of any actions or decisions taken by any of them up to the Closing Date in furtherance of the Project referred to in recital A of this Agreement.
- Further, the Selected Bidder hereby indemnifies and holds harmless at all times the Shares Seller against all past, present and future third party claims and liabilities arising out of actions or decisions taken by any of the persons or bodies referred to in Clause 6 up to the Closing Date in furtherance of the Project referred to above or otherwise concerning the

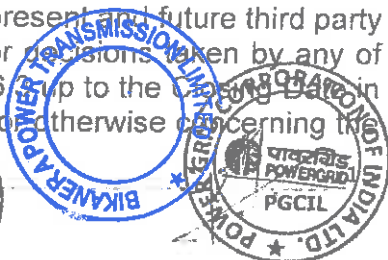
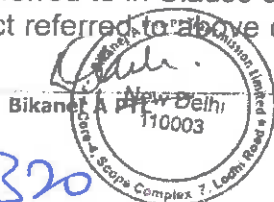
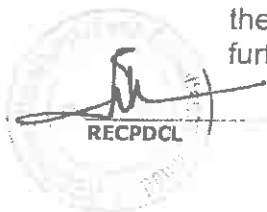

Company. All such actions shall be defended by the Selected Bidder either itself or through the TSP at its own cost.

- The Parties hereby agree that the provisions of this clause shall survive the termination of this Agreement

6.17 SURVIVAL

The provisions of Clause 1 (Definitions and Interpretation), Clause 4 (Representations and Warranties), Clause 6.2 (Resolution of Disputes), Clause 6.7 (Termination), Clause 6.15 (Confidentiality), Clause 6.16 (Indemnification) and other representations, warranties, covenants and provisions contained herein that by their nature are intended to survive, shall survive the termination of this Agreement

6.18 FORCE MAJEURE

No party shall be liable for its inability or delay in performing any of its obligations hereunder if such delay is caused by circumstances beyond the reasonable control of the party including delay caused through flood, riot, Act of God, lightning civil commotion, storm, tempest and earthquake.

IN WITNESS WHEREOF, THE PARTIES HERETO HAVE CAUSED THIS AGREEMENT TO BE DULY EXECUTED AND DELIVERED AS OF THE DAY AND YEAR FIRST ABOVE WRITTEN

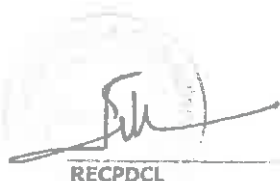
REC PDCL

Bikaner A PT
New Delhi
110003
Scope Complex, T. Lothi Road & Patli



SIGNED AND DELIVERED by the within named **REC POWER DEVELOPMENT AND CONSULTANCY LIMITED** by the hand of Sh. TSC Bosh, CEO

(Authorised pursuant to the resolution passed by its Board of Directors in its meeting held on 21st October, 2024)

IN THE PRESENCE OF:

WITNESS:

(Name and address)

1. **SATYABAN SAHOO**
GM (TECH)

(Core-4, SCOPE Complex, 7, Lodhi Road, New Delhi-110003)

2. **ANIL KUMAR PERALA**
CHIEF MANAGER (ENGG.)

(Core-4, SCOPE Complex, 7, Lodhi Road, New Delhi-110003)

SIGNED AND DELIVERED by the within named **BIKANER A POWER TRANSMISSION LIMITED** by the hand of Sh. Debasis Mitra, Director

(Authorised pursuant to the resolution passed by its Board of Directors in its meeting held on 11th November, 2024)

WITNESS:

(Name and address)

1. **COH.V. LAKSHMANA CHARYULU**
GM & HOD (F)
RECPDCL

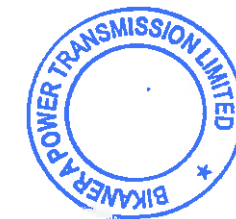

(Core-4, SCOPE Complex, 7, Lodhi Road, New Delhi-110003)

2. **CHANDER MOHAN SHARMA**
DGM (FINANCE)
RECPDCL

(Core-4, SCOPE Complex, 7, Lodhi Road, New Delhi-110003)

SIGNED AND DELIVERED by the within named **POWER GRID CORPORATION OF INDIA LIMITED** by the hand of Shri Pankaj Pandey, ED (TBCB)

(Authorised pursuant to the resolution passed by its Board of Directors in its meeting held on 21st June, 2024)



WITNESS:
(Name and address)

Aditya
d. Aditya Mahesh
Manager (TBCB)

B-9, Qutab Institutional Area,
Katwaria Sarai, New Delhi-110016

Yash
e. Yash Saluja
DGM (TRLP)

B-9, Qutab Institutional Area,
Katwaria Sarai, New Delhi-110016



ANNEXURE A**DESCRIPTION OF THE SALE SHARES**

S. NO.	NAME OF THE SHAREHOLDER	NUMBER OF EQUITY SHARES HELD	PERCENTAGE OF THE TOTAL PAID UP EQUITY CAPITAL
1.	REC POWER DEVELOPMENT AND CONSULTANCY LIMITED	49,994	99.988
2.	SHRI THANGARAJAN SUBASH CHANDIRA BOSH*	1	0.002
3.	SHRI MUKUL AGARWAL*	1	0.002
4.	SHRI CH. V. LAKSHMANA CHARYULU*	1	0.002
5.	SHRI SATYABAN SAHOO*	1	0.002
6.	SHRI ARVIND KUMAR*	1	0.002
7.	SHRI ANIL KUMAR PERALA*	1	0.002
	Total	50,000	100.000

* Held as nominee of REC PDCL.

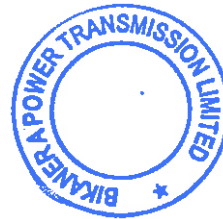

[Handwritten Signature]

RECPDCL



Bikaner A



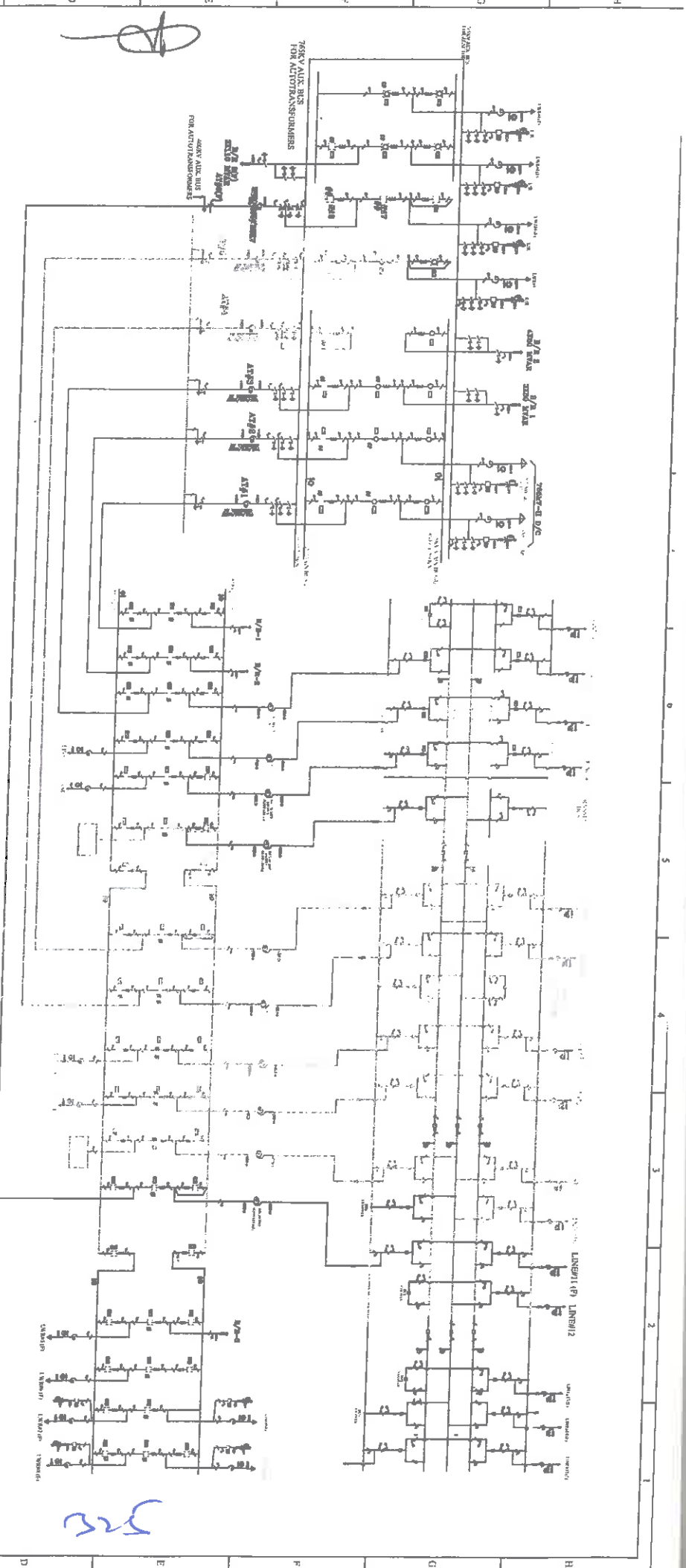

Sl. No.	DESCRIPTION	QTY
1	765KV Busbar (1-10) 10m	10
2	400KV Busbar (1-10) 10m	10
3	765KV Isolator (1-10)	10
4	400KV Isolator (1-10)	10
5	765KV CB (1-10)	10
6	400KV CB (1-10)	10
7	765KV Isolator (1-10) (1-10)	10
8	400KV Isolator (1-10) (1-10)	10
9	765KV Isolator (1-10) (1-10)	10
10	400KV Isolator (1-10) (1-10)	10
11	765KV Isolator (1-10) (1-10)	10
12	400KV Isolator (1-10) (1-10)	10
13	765KV Isolator (1-10) (1-10)	10
14	400KV Isolator (1-10) (1-10)	10
15	765KV Isolator (1-10) (1-10)	10
16	400KV Isolator (1-10) (1-10)	10
17	765KV Isolator (1-10) (1-10)	10
18	400KV Isolator (1-10) (1-10)	10
19	765KV Isolator (1-10) (1-10)	10
20	400KV Isolator (1-10) (1-10)	10

Sl. No.	DESCRIPTION	QTY
1	765KV Isolator (1-10) (1-10)	10
2	400KV Isolator (1-10) (1-10)	10
3	765KV Isolator (1-10) (1-10)	10
4	400KV Isolator (1-10) (1-10)	10
5	765KV Isolator (1-10) (1-10)	10
6	400KV Isolator (1-10) (1-10)	10
7	765KV Isolator (1-10) (1-10)	10
8	400KV Isolator (1-10) (1-10)	10
9	765KV Isolator (1-10) (1-10)	10
10	400KV Isolator (1-10) (1-10)	10
11	765KV Isolator (1-10) (1-10)	10
12	400KV Isolator (1-10) (1-10)	10
13	765KV Isolator (1-10) (1-10)	10
14	400KV Isolator (1-10) (1-10)	10
15	765KV Isolator (1-10) (1-10)	10
16	400KV Isolator (1-10) (1-10)	10
17	765KV Isolator (1-10) (1-10)	10
18	400KV Isolator (1-10) (1-10)	10
19	765KV Isolator (1-10) (1-10)	10
20	400KV Isolator (1-10) (1-10)	10

Sl. No.	DESCRIPTION	QTY
1	765KV Isolator (1-10) (1-10)	10
2	400KV Isolator (1-10) (1-10)	10
3	765KV Isolator (1-10) (1-10)	10
4	400KV Isolator (1-10) (1-10)	10
5	765KV Isolator (1-10) (1-10)	10
6	400KV Isolator (1-10) (1-10)	10
7	765KV Isolator (1-10) (1-10)	10
8	400KV Isolator (1-10) (1-10)	10
9	765KV Isolator (1-10) (1-10)	10
10	400KV Isolator (1-10) (1-10)	10
11	765KV Isolator (1-10) (1-10)	10
12	400KV Isolator (1-10) (1-10)	10
13	765KV Isolator (1-10) (1-10)	10
14	400KV Isolator (1-10) (1-10)	10
15	765KV Isolator (1-10) (1-10)	10
16	400KV Isolator (1-10) (1-10)	10
17	765KV Isolator (1-10) (1-10)	10
18	400KV Isolator (1-10) (1-10)	10
19	765KV Isolator (1-10) (1-10)	10
20	400KV Isolator (1-10) (1-10)	10



FOR DPR/TENDER PURPOSE
POWER GRID CORPORATION OF INDIA LIMITED
 (A Government of India Enterprise)



SUBSTATION: 765/400/220KV BARBAR SUBSTATION
 TITLE: SINGLE LINE DIAGRAM
 DRAWING NO. C/ENGG/NB-1/BARBAR/S/D/1

Handwritten signature or initials in blue ink.

Handwritten signature or mark.

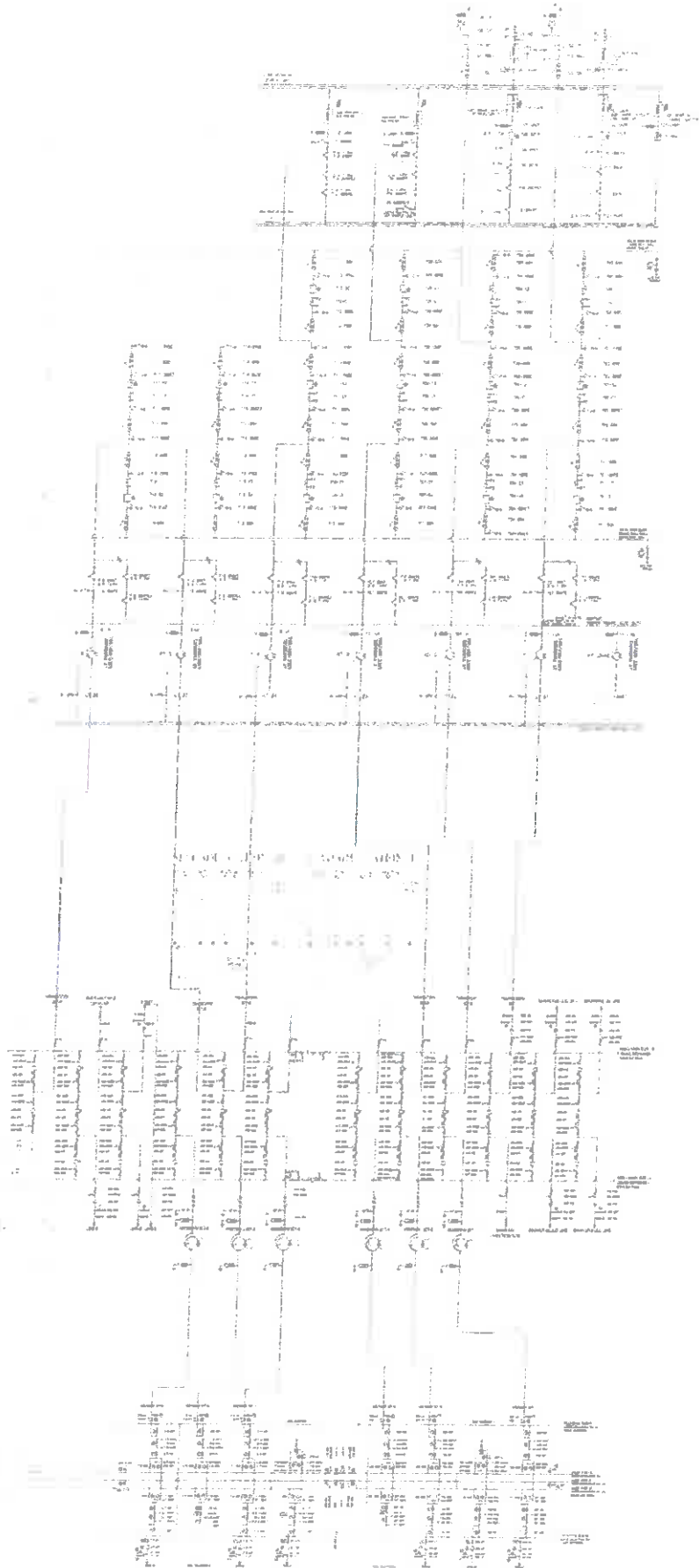

326

POWER GRID CORPORATION OF INDIA LIMITED <small>(A Government of India Enterprise)</small>			
<small>PROJECT - TRANSMISSION SCHEME FOR EVACUATION OF POWER FROM REZ RAJASTHAN (PH-IV) PART 3; PART-A</small>			
<small>TITLE - Single Line Diagram 765 KV BIKANER-IV S/S</small>			
<small>DRAWN BY</small> ABHISHEK	<small>DESIGNED BY</small> C/FNCG, YBI S/BIKANER IV/SLD/01	<small>SCALE</small>	<small>REV</small> 00

1. To constitute, and defend legal cases, sign and verify complaints, written statements, petitions and objections, memorandum of appeal, claims, affidavits, applications, re-applications and pleadings of all kinds and to file them in Central Electricity Regulatory Commission (CERC), State Electricity Regulatory Commissions (SERCs), Appellate Tribunal for Electricity (ATE), Civil, Criminal or Revenue courts, Arbitration, Labour Court, Industrial Tribunal, High Court and Supreme Court, whether having original or appellate jurisdiction and before Government or Local Authorities or Registration Authorities, Tax Authorities, Tribunals, etc.
2. To appear, before various Courts / Tribunals / CERC / SERCs / Appellate Tribunal for Electricity.
3. To appoint any Advocate, Vakil, Pleader, Solicitor or any other legal practitioner as Attorney to appear and conduct case proceedings on behalf of the company and to sign Vakalatnama.
4. To compromise, compound or withdraw cases from any Court / Tribunal / CERC / SERCs / Appellate Tribunal for Electricity.
5. To file petitions/applications or affidavits before the Supreme Court / High Court / CERC / SERCs / Appellate Tribunal for Electricity and to obtain the copies of documents, papers, records etc.
6. To file and receive back documents, to deposit and withdraw money from Courts, Tribunals, Registrar's Office and other Government or Local Authorities and to issue valid receipts thereof.
7. To apply for and obtain refund of stamp duty or court fee, etc.
8. To issue notices and accept service of any summons, notices or orders issued by any Court / Tribunal / CERC / SERCs / Appellate Tribunal for Electricity on behalf of the Company.
9. To execute deeds, agreements, bonds and other documents and returns in connection with the affairs of the company and file them or cause to be filed for Registration, whenever necessary.
10. To issue Project Authority Certificate(s) in respect of contracts for Load Despatch & Communication Systems, Transmission Systems etc. and to lodge claims with the Railways, Transporters, Shipping Agents and Clearing Agents and to settle/compromise such claims.
11. To lodge claims with the Insurance companies, to settle/compromise such claims and on satisfactory settlement thereof, to issue letters of subrogation/power of attorney in favour of Insurance companies.
12. To execute, sign and file applications, undertakings, agreements etc. to or with the Central / State Government(s) / Body(ies) to obtain 'right of way' or any of other Right(s) / Privilege(s) etc.
13. To execute, sign and file applications, undertakings, agreements, bills, documents etc. to or with the Central / State Government(s) / Body(ies) and other authorities / entities including Central Transmission Utility (CTU)/Power System Operation Corporation Limited (POSOCO) / Central Electricity Authority (CEA)/ CERC with respect to Commissioning

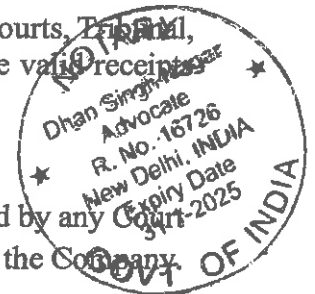

ASD(P)

B. Kumar

328

of the Project, realization of Transmission charges, to obtain 'right of way' or any of other Right(s) / Privilege(s) etc.

14. To execute Transmission Service Agreement (TSA) with Central Transmission Utility of India Limited (CTUIL)
15. To execute Consultancy, Funding and other Agreements.
16. To act as administrator for e-filing process with CERC and other Statutory authorities.
17. Generally to do all lawful acts, necessary for the above mentioned purposes.

The Company hereby agrees to ratify and confirm all and whatsoever the said Attorney shall lawfully do execute or perform or cause to be done, executed or performed in exercise of the power or authority conferred under and by virtue of this Power of Attorney.

OSD(P) *[Signature]*

Signed by the within named
Bikaner A Power Transmission Limited
through the hand of
Duly authorized by the Board to issue such Power of Attorney

Dated this 11th day of Nov, 2024

Accepted

NK *[Signature]*

Signature of Attorney

Name: Sh. Naresh Kumar

Designation: Finance Incharge, **Bikaner A Power Transmission Limited**

Address: Flat No. 304, Luxmi Apartment, Sec10-A, Gurugram - 122001



NK *[Signature]*

Attested

OSD(P) *[Signature]*

(Signature of the Executant)

Name: *Burra Vamsi Rama Mohan*

Designation: *Chairman*

Address: B-9, Qutab Institutional Area, Katwaria Sarai, New Delhi - 110 016

.....
Signature and Stamp of Notary of the place of execution

WITNESS

ATTESTED

[Signature]
NOTARY PUBLIC
NEW DELHI. (INDIA)

11 NOV 2024

329