

BEFORE THE CENTRAL ELECTRICITY REGULATORY COMMISSION

NEW DELHI

APPLICATION No :.....

**IN THE MATTER OF**

Application under Section 63 of the Electricity Act, 2003 for Adoption of Transmission Charges with respect to the Transmission System being established by the Rajasthan IV H1 Power Transmission Limited(a 100% wholly owned subsidiary of Power Grid Corporation of India Limited)

**Rajasthan IV H1 Power Transmission Limited**

(A 100% wholly owned subsidiary of Power Grid Corporation of India Limited)

Registered office: B-9, Qutab Institutional Area, Katwaria Sarai, New Delhi 110 016

Address for correspondence: C/o ED (TBCB), Power Grid Corporation of India Limited, Saudamini, Plot no.2, Sector -29, Gurgaon 122001

**AND**

Chief Operating Officer,  
Central Transmission Utility of India Ltd,  
Saudamini, Plot no.2, Sector -29,  
Gurgaon 122001.....

**RESPONDENT(S)**

And Others

**INDEX**

Sl. No.	Description	Enclosures	Page No.
1	CERC Letter	-	3
2	Form 1	-	04-05
3	Memo of Appearance		06
4	Dispatch proof	-	06A
5	Letter for registration	-	10
6	Memo of parties	-	11-14
7	Affidavit	-	15-16
8	Application	-	17-23
9	Extract of Gazette notification no. 3733 [F.No. 15/3/2018-Trans-Part (1) dated 04.09.2023 has notified REC Power Development and Consultancy Limited to be the Bid Process Coordinator (BPC)	Annexure-1	24-27
10	Certificate of Incorporation of Rajasthan IV H1 Power Transmission Limited	Annexure-2	28
11	Memorandum of Association and Articles of	Annexure-3	29-58

1

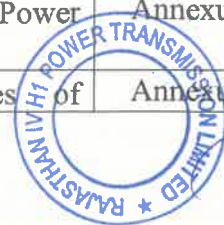

	Association of Rajasthan IV H1 Power Transmission Limited		
12	Global Invitation for Qualification as published in the newspapers	Annexure-4	59
13	Extract of the RFP document as provided by BPC	Annexure-5	60-61
14	Certificate by Bid Evaluation Committee	Annexure-6	62
15	Copy of Letter of Intent (LoI)	Annexure-7	63-69
16	Copy of relevant extract of Request for Proposal (RFP) along with letters from BPC	Annexure-8	70-73
17	Copy of Transmission Service Agreement (TSA)	Annexure-9	74-224
18	Copy of the BPC letters dated 01.01.2024 and 28.09.2024	Annexure-10	225-226
19	Copy of Share purchase agreement (SPA)	Annexure-11	227-246
20	SLD of the transmission scheme	Annexure-12	247

*[Handwritten Signature]*

**FILED BY**

**Rajasthan IV H1 Power Transmission Limited**

**Place: New Delhi**

**Date: 22/10/2024**



# Rajasthan IV H1 Power Transmission Limited

( A 100% wholly owned subsidiary Power Grid Corporation of India Limited)

B-9, Qutab Institutional Area, Katwaria Sarai, New Delhi - 110 016

CIN : U42202DL2023GOI421335

Ref: PG\_RIVH1PTL/

Dated: 22/10/2024

To,  
The Secretary,  
Central Electricity Regulatory Commission,  
7th Floor, Tower B, World Trade Centre,  
Nauroji Nagar, New Delhi-110029.

Sub.: Application under Section 63 of the Electricity Act, 2003 for Adoption of Transmission Charges with respect to the Transmission System being established by the Rajasthan IV H1 Power Transmission Limited(a 100% wholly owned subsidiary of Power Grid Corporation of India Limited)

Sir,

Three copies (1 original + 2 copies) of the application for the above subject matter have been enclosed and e-filing has been done on CERC website. As per the public notice issued on 28.08.2010 by the Hon'ble Commission, the amount of Rs. 25,00,000/- (Rupees Twenty Five Lakhs only) for filing the application is being paid through RTGS and in accordance with the Regulations 12 (2), Payment of Fees Regulations 2012, Form-1 duly filled in against the aforementioned application is also enclosed herewith.

Electronic Copies of the application are being forwarded to the CTUIL (Nodal Agency) and to the Bid Process Coordinator and beneficiaries of the Western Region as party to the Petition based on the list of the beneficiaries furnished by the CTUIL. The complete application along with Annexures is posted on the website: [www.powergrid.in/subsidiaries](http://www.powergrid.in/subsidiaries)

Thanking You,



Yours faithfully,

(Rajendra Kumar Gupta)

Project Incharge

Rajasthan IV H1 Power Transmission Limited

Mobile: +91- 9560890039; email : [tcbcb@powergrid.in](mailto:tcbcb@powergrid.in)

Enclosures: As above

3

**Form-I**

**Particulars**

1. Name of the Petitioner : **Rajasthan IV H1 Power Transmission Limited**  
(A 100% wholly owned subsidiary of  
Power Grid Corporation of India Limited)
2. Address of the Petitioner/Applicant : **Rajasthan IV H1 Power Transmission Limited**  
(A 100% wholly owned subsidiary of Power Grid Corporation of India Limited)  
Regd. Address:  
B-9, Qutab Institutional Area,  
Katwaria Sarai, New Delhi-110 016  
Address for correspondence:  
Project Incharge, Rajasthan IV H1 Power  
Transmission Limited, C/o ED(TBCB), Power  
Grid Corporation of India Ltd, Saudamini, Plot  
no.2, Sector - 29, Gurgaon 122001
3. Subject Matter : Application under Section 63 of the Electricity Act,  
2003 for Adoption of Transmission Charges with  
respect to the Transmission System being  
established by the Rajasthan IV H1 Power  
Transmission Limited(a 100% wholly owned  
subsidiary of Power Grid Corporation of India  
Limited)
4. Petition No., if any : Not yet received
5. Details of generation assets : NOT APPLICABLE  
(a) generating station/units  
(b) Capacity in MW  
(c) Date of commercial operation  
(d) Period for which fee paid  
(e) Amount of fee paid  
(f) Surcharge, if any
6. Details of transmission assets : Assets under implementation by  
Rajasthan IV H1 Power Transmission Limited  
(a) Transmission line and sub-stations  
(b) Date of commercial operation  
(c) Period for which fee paid  
(d) Amount of fee paid  
(g) Surcharge, if any
7. Fee paid for Adoption of tariff for :  
(a) Generation asset NO

(W)







(b) Transmission asset YES

8. Application fee for licence : NOT APPLICABLE

(a) Trading licence

(b) Transmission licence

(c) Period for which paid

(d) Amount of fee paid

9. Fees paid for Miscellaneous Application : NOT APPLICABLE

10. Fees paid for Interlocutory Application : NOT APPLICABLE

11. Fee paid for Regulatory Compliance petition : NOT APPLICABLE

12. Fee paid for Review Application : NOT APPLICABLE

13. Licence fee for inter-State Trading : NOT APPLICABLE

(a) Category

(b) Period

(c) Amount of fee paid

(d) Surcharge, if any

14. Licence fee for inter-State Transmission : NOT APPLICABLE

(a) Expected/Actual transmission charge

(b) Period

(c) Amount of fee calculated as a percentage of transmission charge.

(d) Surcharge, if any

15. Annual Registration Charge for Power Exchange : NOT APPLICABLE

(a) Period

(b) Amount of turnover

(c) Fee paid

(d) Surcharge, if any

16. Details of fee remitted

(a) UTR No.

: ICICR22024102205848179

(b) Date of remittance

: 22/10/2024

(c) Amount remitted

: Rs.25,00,000 (Rupees Twenty Five Lakh only)



Signature of the authorized signatory with date

5



**BEFORE  
THE CENTRAL ELECTRICITY REGULATORY COMMISSION**

**NEW DELHI**

Petition No.: -----

**IN THE MATTER OF:** Application under Section 63 of the Electricity Act, 2003 for Adoption of Transmission Charges with respect to the Transmission System being established by the Rajasthan IV H1 Power Transmission Limited (a 100% wholly owned subsidiary of Power Grid Corporation of India Limited)

**MEMO OF APPEARANCE**

**Rajasthan IV H1 Power Transmission Limited --- PETITIONER**

1. Pankaj Pandey, ED, POWERGRID
2. Shri Rajendra Kumar Gupta, Project Incharge, Rajasthan IV H1 Power Transmission Limited
3. Ashwini Kumar Das, GM, POWERGRID

**Filed by  
Rajasthan IV H1 Power Transmission Limited  
Represented by**

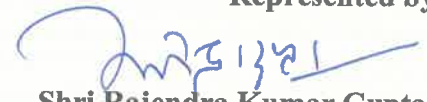

**Shri Rajendra Kumar Gupta  
Project Incharge  
(Rajasthan IV H1 Power Transmission Limited)**

**Place: Gurgaon**

**Date: 22/10/2024**



⑤

## Lingolu Aditya Mahesh (लिंगोलु आदित्य महेश)

**From:** tbc  
**Sent:** 22 October 2024 20:19  
**To:** tbc; anish.p@greenkogroup.com; pavan.gupta@junipergreenenergy.com; bd@junipergreenenergy.com; cecomcseb@rediffmail.com; Manoj.K@cspc.co.in; eediv3@yahoo.co.in; decsp.guvnl@gebmail.com; aocom2.guvnl@gebmail.com; dksingh@mum.hwb.gov.in; dksingh1164@yahoo.com; wr1commercial; Manoj Kumar Tripathi (मनोज कुमार त्रिपाठी); wr1commercial; Manoj Kumar Tripathi (मनोज कुमार त्रिपाठी); rajvarman.saxena@mppmcl.com; comml.deptt@mppmcl.com; gmppmsedcl@gmail.com; ceppmsedcl@gmail.com; acbpower@acbindia.com; lopamudra.kashyap@acbindia.com; satyanarayansoni@torrentpower.com; Niralishah@torrentpower.com; oa\_commercial.seil@sembcorp.com; Prasanta Kumar Mahalik (पी.के. महालिक); spotsales.india@sembcorp.com; electricitybill@barctara.gov.in; craman@barc.gov.in; Santu.Pal@gmrgroup.in; wr1commercial; Manoj Kumar Tripathi (मनोज कुमार त्रिपाठी); dyceetrdwcr@gmail.com; cede@wr.railnet.gov.in; solar-india1@engie.com; naresh.baluja@engie.com; vishal.saxena@engie.com; sales@dbpower.in; sanjay.jadhav@dbpower.in; ce.techcell@gmail.com; Manoj.K@cspc.co.in; acbpower@acbindia.com; lopamudra.kashyap@acbindia.com; naresh.yadav@amns.in; cesecrly@gmail.com; dyceetrdcrly@gmail.com; bhavikshah@torrentpower.com; namanshah@torrentpower.com; rajesh.sirigirisetty@adani.com; RECPDCL Satyabhan Sahoo Sir; tbc@recpdcl.in; Swapnil Verma (स्वप्निल वर्मा); Kashish Bhambhani (कशिष भम्भानी); Anil Kr Meena (अनिल कुमार मीना)  
**Cc:** Pankaj Pandey (पंकज पाण्डेय); Ashwini Kr Das (अश्विनी कुमार दास); Lingolu Aditya Mahesh (लिंगोलु आदित्य महेश); Vikas Kumar (विकास कुमार)  
**Subject:** Rajasthan IV H1 Power Transmission Limited: Application under Section 63 of the Electricity Act, 2003 for Adoption of Transmission Charges  
**Attachments:** AoTC\_Raj IV H1\_email.PDF

Dear Sir/Mam,

The following application is being filed before CERC:

Application under Section 63 of the Electricity Act, 2003 for Adoption of Transmission Charges with respect to the Transmission System being established by the Rajasthan IV H1 Power Transmission Limited (a 100% wholly owned subsidiary of Power Grid Corporation of India Limited)

The soft copy of this application is attached with this mail for your kind information and necessary action please.

With Regards,

**Rajasthan IV H1 Power Transmission Limited**



**BEFORE**  
**THE CENTRAL ELECTRICITY REGULATORY**  
**COMMISSION**  
**NEW DELHI**

**Application under Section 63 of the Electricity Act, 2003 for adoption of Transmission charges with respect to the Transmission System being established by the Rajasthan IV H1 Power Transmission Limited(a 100% wholly owned subsidiary of Power Grid Corporation of India Limited)**

**APPLICATION NO :**

**Rajasthan IV H1 Power Transmission Limited**  
**(A 100% wholly owned subsidiary of Power Grid Corporation of India Limited)**

**Registered office:**

B-9, Qutab Institutional Area, Katwaria Sarai, New Delhi 110 016

**Address for correspondence:**

C/o ED (TBCB), Power Grid Corporation of India Limited  
Saudamini, Plot no.2, Sector -29, Gurgaon 122001  
**GURGAON-122 001 (HARYANA)**



**BEFORE THE CENTRAL ELECTRICITY REGULATORY COMMISSION  
NEW DELHI**

APPLICATION No :.....

**IN THE MATTER OF**

Application under Section 63 of the Electricity Act, 2003 for Adoption of Transmission Charges with respect to the Transmission System being established by the Rajasthan IV H1 Power Transmission Limited(a 100% wholly owned subsidiary of Power Grid Corporation of India Limited)

**Rajasthan IV H1 Power Transmission Limited**

(A 100% wholly owned subsidiary of Power Grid Corporation of India Limited)

Registered office: B-9, Qutab Institutional Area, Katwaria Sarai, New Delhi 110 016

Address for correspondence: C/o ED (TBCB), Power Grid Corporation of India Limited, Saudamini, Plot no.2, Sector -29, Gurgaon 122001

**AND**

Chief Operating Officer,  
Central Transmission Utility of India Ltd,  
Saudamini, Plot no.2, Sector -29,  
Gurgaon 122001.....

**RESPONDENT(S)**

And Others

**INDEX**

Sl. No	Description	Annexure No.	Page No.
1.	Letter for registration	-	10
2.	Memo of parties	-	11-14
3.	Affidavit	-	15-16
4.	Application	-	17-23
5.	Extract of Gazette notification no. 3733 [F.No. 15/3/2018-Trans-Part (1) dated 04.09.2023 has notified REC Power Development and Consultancy Limited to be the Bid Process Coordinator (BPC)	Annexure-1	24-27
6.	Certificate of Incorporation of Rajasthan IV H1 Power Transmission Limited	Annexure-2	28
7.	Memorandum of Association and Articles of Association of Rajasthan IV H1 Power	Annexure-3	29-58

8

*[Handwritten Signature]*



	Transmission Limited		
8.	Global Invitation for Qualification as published in the newspapers	Annexure-4	59
9.	Extract of the RFP document as provided by BPC	Annexure-5	60-61
10.	Certificate by Bid Evaluation Committee	Annexure-6	62
11.	Copy of Letter of Intent (LoI)	Annexure-7	63-69
12.	Copy of relevant extract of Request for Proposal (RFP) along with letters from BPC	Annexure-8	70-73
13.	Copy of Transmission Service Agreement (TSA)	Annexure-9	74-224
14.	Copy of the BPC letters dated 01.01.2024 and 28.09.2024	Annexure-10	225-226
15.	Copy of Share purchase agreement (SPA)	Annexure-11	227-246
16.	SLD of the transmission scheme	Annexure-12	247

Filed by  
**Rajasthan IV H1 Power Transmission Limited**  
(A 100% wholly owned subsidiary of Power Grid Corporation of India Limited)



Represented by **Rajendra Kumar Gupta**  
Project Incharge, Rajasthan IV H1 Power Transmission Limited

Place: New Delhi

Date: 15/10/2024



9



**BEFORE THE CENTRAL ELECTRICITY REGULATORY COMMISSION  
NEW DELHI**

**APPLICATION No :.....**

**IN THE MATTER OF**

Application under Section 63 of the Electricity Act, 2003 for Adoption of Transmission Charges with respect to the Transmission System being established by the Rajasthan IV H1 Power Transmission Limited (a 100% wholly owned subsidiary of Power Grid Corporation of India Limited)

**Rajasthan IV H1 Power Transmission Limited**

(A 100% wholly owned subsidiary of Power Grid Corporation of India Limited)

**Registered office:** B-9, Qutab Institutional Area, Katwaria Sarai, New Delhi 110 016

**Address for correspondence:** C/o ED (TBCB), Power Grid Corporation of India Limited, Saudamini, Plot no.2, Sector -29, Gurgaon 122001

**AND**

Chief Operating Officer,  
Central Transmission Utility of India Ltd,  
Saudamini, Plot no.2, Sector -29,  
Gurgaon 122001.....

**RESPONDENT(S)**

And Others

To  
The Secretary  
Central Electricity Regulatory Commission  
New Delhi

Sir,

The application filed under Section 63 of the Electricity Act, 2003 for Adoption of Transmission Charges with respect to the Transmission System being established by the Rajasthan IV H1 Power Transmission Limited (A 100% wholly owned subsidiary of Power Grid Corporation of India Limited) for which transmission charges are determined through transparent process of bidding in accordance with the guidelines issued by the Central Government, may please be registered.

**Applicant**

**Rajasthan IV H1 Power Transmission Limited**

(A 100% wholly owned subsidiary of Power Grid Corporation of India Limited)



Represented by Shri Rajendra Kumar Gupta  
Project Incharge, Rajasthan IV H1 Power Transmission Limited

**Place: New Delhi**

**Date: 15/10/2024**





**BEFORE THE CENTRAL ELECTRICITY REGULATORY COMMISSION  
NEW DELHI**

**APPLICATION No : .....**

**IN THE MATTER OF**

Application under Section 63 of the Electricity Act, 2003 for Adoption of Transmission Charges with respect to the Transmission System being established by the Rajasthan IV H1 Power Transmission Limited (a 100% wholly owned subsidiary of Power Grid Corporation of India Limited)

**Rajasthan IV H1 Power Transmission Limited**

**(A 100% wholly owned subsidiary of Power Grid Corporation of India Limited)**

**Registered office:** B-9, Qutab Institutional Area, Katwaria Sarai, New Delhi 110 016

**Address for correspondence:** C/o ED (TBCB), Power Grid Corporation of India Limited, Saudamini, Plot no.2, Sector -29, Gurgaon 122001

**AND**

Chief Operating Officer,  
Central Transmission Utility of India Ltd,  
Saudamini, Plot no.2, Sector -29,  
Gurgaon 122001

And Others

To  
The Secretary  
Central Electricity Regulatory Commission  
New Delhi

**MEMO OF PARTIES**

Rajasthan IV H1 Power Transmission Limited

**(A 100% wholly owned subsidiary of Power Grid Corporation of India Limited)**

**Registered office:** B-9, Qutab Institutional Area, Katwaria Sarai, New Delhi 110 016

**Address for correspondence:** C/o ED (TBCB), Power Grid Corporation of India Limited, Saudamini, Plot no.2, Sector -29, Gurgaon 122001

**VERSUS**

1.	Chief Operating Officer, Central Transmission Utility of India Ltd, Saudamini, Plot no.2, Sector -29, Gurgaon 122001	....Respondent
----	---	----------------

11



2.	REC Power Development and Consultancy Limited REC Corporate Head Quarter, D Block, Plot No. I - 4, Sec - 29 Gurugram - 122 001	....Respondent
3.	General Manager Greenko MP01 IREP Pvt. Ltd. 15th Floor, Hindustan Times House, 18-20 KG Marg, Delhi	....Respondent
4.	Authorized Signatory Juniper Green Energy Pvt. Ltd. Plot No. 18, 1st Floor, Institutional Area, Sector-32, Gurgaon, Haryana - 122001	....Respondent
5.	Chhatisgarh State Power Distribution Co. Ltd. CSPDCL, Post: Sundernagar, Dangania, Raipur-492013	....Respondent
6.	Goa Electricity Department-WR Goa Electricity Dept Curti, Ponda 403401	....Respondent
7.	Gujarat Urja Vikas Nigam Limited Sardar Patel Vidyut Bhavan, Racecourse Vadodara - 390007	....Respondent
8.	Heavy Water Board O FLOOR, VIKRAM SARABHAI BHAVAN, TROMBAY, ANUSHAKTINAGAR, MUMBAI - 400094 , Maharashtra	....Respondent
9.	HVDC Bhadrawati, PGCIL PGCIL RHQ, WR-I, Sampriti Nagar, , Off National Highway No. 8, Taluka : Kamrej, PO: Uppalwadi , Nagpur , 440026 Maharashtra	....Respondent
10.	HVDC Vindhyachal, PGCIL PGCIL RHQ, WR-I, Sampriti Nagar, , Off National Highway No. 8, Taluka : Kamrej, PO: Uppalwadi , Nagpur , 440026 Maharashtra	....Respondent
11.	M.P. Power Management Company Ltd. 14, Shakti Bhawan, Rampur, Jabalpur - 482008	....Respondent
12.	MSEDCL Plot No 9, "prakashgad", A K Marg, Bandra East, Mumbai 400051	....Respondent

12



13.	ACB India LIMITED 7th Floor, Corporate Tower, Ambience Mall, NH-8, Gurgaon-122 001(Haryana)	....Respondent
14.	Torrent Power Limited Torrent Power Ltd. Naranpura Zonal Office, Sola Road, Ahmedabad, 380013	....Respondent
15.	Thermal Powertech Corporation India 6-3-1090, Clock C, Level 2, TSR , Towers, Rajbhavan Road, Somajiguda , Hyderabad , 500082, Telangana	....Respondent
16.	BARC Bhabha Atomic Research Centre, Anushakti Nagar, Mumbai, Maharashtra – 400085	....Respondent
17.	GMR Warora Energy Limited Plot B-1,GMR Warora Energy Ltd, Mohabala MIDC Growth Centre, Post – Warora, Dist – Chandrapur, Maharashtra, PIN 442907	....Respondent
18.	HVDC Champa PGCIL RHQ, WR-I, Sampriti Nagar, , Off National Highway No. 8, Taluka : Kamrej,PO: Uppalwadi , Nagpur , 440026 Maharashtra	....Respondent
19.	West Central Railway Head Office General Manager's Office,Electrical Branch, Jabalpur– 482 001.	....Respondent
20.	Western Railway Office Of Chief Electrical EngineerMumbai	....Respondent
21.	DB Power Limited- Untied Opp Dena Bank, C-31, G- BlockMumbai	....Respondent
22.	Chhattisgarh State Power Trading Co. Ltd. 2nd floor Vidyut Sewa BhawanRaipur	....Respondent
23.	TRN Energy Private Ltd-Untied 7th Floor, Ambience Office BlockGurugram	....Respondent
24.	Adani Power (Mundra) Limited. Adani Corporate House, Shantigram, Near Vaishnavdevi Circle, S G Road Ahmedabad - 382421	....Respondent

13



2

25.	Raigarh HVDC Station RPT HVDC Office, Hebbal, Bangalore – 560094	....Respondent
26.	Arcelor Mittal Nippon Steel India Ltd. 27,AMNS House, 2TH KM Surat Hazira road, Hazira-394270, Gujarat	....Respondent
27.	Central Railway Pcee's office 2nd floor parcle building csmt mumbai-400001	....Respondent
28.	Dadra and Nagar Haveli and Daman an Power Distribution Corporation Ltd 1st & 2nd Floor, Vidyut Bhavan, NexSilvassa & Daman	....Respondent
29.	MPSEZ Utilities Ltd. 3rd Floor, Adani Corporate House, SAhmedabad	....Respondent

(14)



*[Handwritten signature]*



**BEFORE THE HON'BLE CENTRAL ELECTRICITY REGULATORY COMMISSION  
NEW DELHI**

**APPLICATION NO:.....**

**IN THE MATTER OF**

Application under Section 63 of the Electricity Act, 2003 for Adoption of Transmission Charges with respect to the Transmission System being established by the Rajasthan IV H1 Power Transmission Limited (a 100% wholly owned subsidiary of Power Grid Corporation of India Limited)

**Rajasthan IV H1 Power Transmission Limited**

**(A 100% wholly owned subsidiary of Power Grid Corporation of India Limited)**

**Registered office:** B-9, Qutab Institutional Area, Katwaria Sarai, New Delhi 110 016

**Address for correspondence:** C/o ED (TBCB), Power Grid Corporation of India Limited, Saudamini, Plot no.2, Sector -29, Gurgaon 122001

**AND**

Chief Operating Officer,  
Central Transmission Utility of India Ltd,  
Saudamini, Plot no.2, Sector -29,  
Gurgaon 122001.....

**RESPONDENT(S)**

And Others

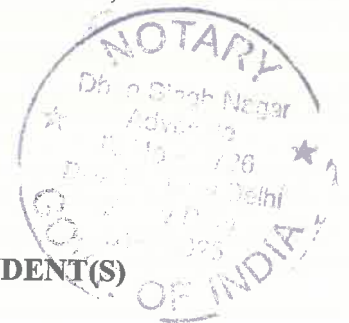

**AFFIDAVIT**

I, Rajendra Kumar Gupta, S/o Shri Moti Lal Gupta residing at D2, POWERGRID Township, Patan Road, Sukha, Jabalpur, MP-482002 do hereby solemnly affirm and state as follows:

1. I am the Authorised Signatory of the Applicant Company in the above matter and I am duly authorized by the Applicant Company to affirm this affidavit. I say that I am conversant with the facts and circumstances of this case.
2. The statements made in paragraphs of the application, are true to my knowledge and belief based on the information received and I believe them to be true.

(15)





3. I say that there are no proceedings pending in any court of law/ tribunal or arbitrator or any other authority, wherein the Applicant is a party and where issues arising and/ or reliefs sought are identical or similar to the issues in the matter pending before the Hon'ble Commission.



Rajendra Kumar Gupta  
Authorised Signatory

**Rajasthan IV H1 Power Transmission Limited**  
(A 100% wholly owned subsidiary of Power Grid Corporation of India Limited)

**Place: New Delhi**

**Date: 15/10/2024**

**VERIFICATION:**

I, the Deponent above named hereby solemnly hereby affirms that the contents of my above affidavit are true to my knowledge, no part of it is false and nothing material has been concealed there from. Verified by me on this the 15<sup>th</sup> day of . October 2024 at New Delhi.

**Witness**



**Deponent**



ATTESTED  
NO. 15/10/2024  
PUBLIC

15 OCT 2024

16

BEFORE THE CENTRAL ELECTRICITY REGULATORY COMMISSION  
NEW DELHI

APPLICATION NO:.....

IN THE MATTER OF

Application under Section 63 of the Electricity Act, 2003 for Adoption of Transmission Charges with respect to the Transmission System being established by the Rajasthan IV H1 Power Transmission Limited (a 100% wholly owned subsidiary of Power Grid Corporation of India Limited)

**Rajasthan IV H1 Power Transmission Limited**

(A 100% wholly owned subsidiary of Power Grid Corporation of India Limited)

Registered office: B-9, Qutab Institutional Area, Katwaria Sarai, New Delhi 110 016

Address for correspondence: C/o ED (TBCB), Power Grid Corporation of India Limited, Saudamini, Plot no.2, Sector -29, Gurgaon 122001

AND

Chief Operating Officer,  
Central Transmission Utility of India Ltd,  
Saudamini, Plot no.2, Sector -29,  
Gurgaon 122001.....

RESPONDENT(S)

And Others

Application

The Applicant respectfully submits as under:

1. The Government of India, Ministry of Power, vide Gazette notification no. 3733 [F.No. 15/3/2018-Trans-Part (1) dated 04.09.2023 has notified REC Power Development and Consultancy Limited (RECPDCL) as the Bid Process Coordinator (hereinafter referred to as BPC) for the purpose of selection of Bidder as Transmission Service Provider (TSP) to establish Inter-State Transmission System for "Transmission system for evacuation of power from Rajasthan REZ Ph-IV (Part-2 :5.5 GW) (Jaisalmer/ Barmer Complex): Part H1" on build, own, operate and transfer basis. A copy of the notification is enclosed and marked as Annexure-1, (Page ..24..... to Page ..27.....).



The project consists of the following elements:

Sr. No	Name of the Transmission Element	Scheduled COD in months from Effective Date	Percentage of Quoted Transmission Charges recoverable on Scheduled COD of the Element of the Project	Element(s) which are pre-required for declaring the commercial operation (COD) of the respective Element
1.	<p>Establishment of 765/400 kV (2x1500 MVA), 400/220 kV (2x500 MVA) &amp; 220/132 kV (3x200 MVA) Kurawar S/s with 2x330 MVAR 765 kV bus reactor and 1x125 MVAR, 420 kV bus reactor</p> <ul style="list-style-type: none"> <li>• 765/400 kV, 1500 MVA ICT – 2 (7 single units of 500 MVA including one spare unit)</li> <li>• 400/220 kV, 500 MVA ICT – 2</li> <li>• 220/132 kV, 200 MVA ICT – 3</li> <li>• 765 kV ICT bays- 2</li> <li>• 400 kV ICT bays- 4</li> <li>• 220 kV ICT bays – 5</li> <li>• 132 kV ICT bays - 3</li> <li>• 330 MVAR 765 kV bus reactor-2</li> <li>• 125 MVAR 420 kV bus reactor-1</li> <li>• 765 kV reactor bay- 2</li> <li>• 765 kV line bays- 4</li> <li>• 400 kV line bays- 4</li> <li>• 400 kV reactor bay- 1</li> <li>• 220 kV BC – 1</li> <li>• 220 kV TBC – 1</li> <li>• 132 kV TBC – 1</li> <li>• 110 MVAR, 765 kV, 1-ph reactor (spare unit)-1</li> <li>• 80 MVAR, 765 kV, 1-ph reactor (spare unit)-1</li> </ul> <p>Future Provisions:</p> <p>Space for</p> <ul style="list-style-type: none"> <li>• 765/400 kV ICT along with bays- 4</li> </ul>	24 months from SPV transfer	21.25%	All elements of the scheme are required to be commissioned simultaneously as their utilization is dependent on each other.



	<p>no.</p> <ul style="list-style-type: none"> <li>• 765 kV line bays along with switchable line reactors – 8 nos.</li> <li>• 765 kV Bus Reactor along with bay: 2 no.</li> <li>• 765 kV Sectionalizer bay: 1 -set</li> <li>• 400 kV line bays along with switchable line reactor – 8 nos.</li> <li>• 400/220 kV ICT along with bays - 6 nos.</li> <li>• 420 kV Bus Reactor along with bay: 3no.</li> <li>• 400 kV Sectionalization bay: 1- set</li> <li>• 220 kV line bays: 12 nos.</li> <li>• 220 kV Sectionalization bay: 1set</li> <li>• 220 kV BC and TBC: 1 no.</li> <li>• 220/132 kV ICT along with bays: 5 Nos.</li> <li>• 132 kV line bays: 16 nos.</li> <li>• 132 kV Sectionalization bay: 1 set</li> <li>• 132 kV TBC- 1 no.</li> <li>• STATCOM (<math>\pm 300</math> MVAR) along with MSC (2x125 MVAR) &amp; MSR (1x125 MVAR) along with 400 kV bay.</li> </ul>			
2.	<ul style="list-style-type: none"> <li>• Mandsaur – Kurawar 765 kV D/c line</li> <li>• 240 MVAR switchable line reactors on each ckt at both ends of Mandsaur – Kurawar 765 kV D/c line</li> <li>• 2 nos. of 765 kV line bays at Mandsaur S/s for termination of Mandsaur – Kurawar 765 kV D/c line</li> </ul>		54.20%	
3.	LILO of Indore – Bhopal 765 kV S/c line at Kurawar		4.88%	
4.	<ul style="list-style-type: none"> <li>• Kurawar – Ashta 400 kV D/c (Quad ACSR/AAAC/AL59 moose equivalent) line</li> <li>• 2 nos. of 400 kV line bays at Ashta (MP) S/s for termination of Kurawar – Ashta 400 kV D/c line</li> </ul>		7.57%	
5.	<ul style="list-style-type: none"> <li>• LILO of one circuit of Indore – Itarsi 400 kV D/c line at Ashta</li> <li>• 2 nos. of 400 kV line bays at Ashta</li> </ul>		7.74%	

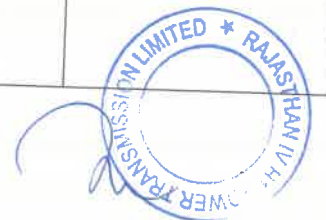

	(MP) S/s for LILO of one circuit of Indore – Itarsi 400 kV D/c line at Ashta		
6.	<ul style="list-style-type: none"> <li>• Shujalpur – Kurawar 400 kV D/c (Quad ACSR/AAAC/AL59 moose equivalent) line</li> <li>• 2 nos. of 400 kV line bays at Shujalpur (PG) S/s for termination of Shujalpur – Kurawar 400 kV D/c line</li> </ul>	4.36%	

Note:

- MPPTCL has confirmed availability of space for 2 nos. 400 kV bays at Ashta (MP) S/s and for 2 nos. additional bays, MPPTCL has informed that adjacent land is private land and may be purchased by the project developer at their cost as per requirement.*
  - Implementation of A, B, C, D, E, F, H1 and H2 packages shall be aligned.*
  - TSP of the subject scheme shall implement Inter-tripping scheme on Mandsaur – Kurawar 765 kV D/c line (for tripping of the switchable line reactor at Mandsaur/Kurawar end along with the main line breaker).*
  - Switchable line reactors shall be implemented with NGR bypass arrangement.*
  - Developer of Mandsaur S/s shall provide space for 2 Nos. 765 kV line bays for Mandsaur - Kurawar 765 kV D/c line along with space for 2 nos. of 240 MVAR switchable line reactor and space for spare 80 MVAR single phase reactor unit.*
  - POWERGRID shall provide space for 2 Nos. 400 kV line bays at Shujalpur S/s for Shujalpur – Kurawar 400 kV D/c line*
- That a company under the Companies Act 2013 by the name “**Rajasthan IV H1 Power Transmission Limited**” having its registered office at New Delhi has been incorporated on 13.10.2023 by RECPDCL as its wholly owned subsidiary to initiate the activities for execution of the Project and subsequently to act as Transmission Service Provider (TSP) after being acquired by the successful bidder selected through Tariff Based Competitive Bidding process. A copy of the Certificate of Incorporation is enclosed and marked as **Annexure-2, (Page ...28..... to Page ...28.....)** and a copy of the Memorandum of Association and Articles of Association is enclosed and marked as **Annexure-3, (Page ...29..... to Page ...58.....)**.
  - BPC has initiated the selection of successful bidder to acquire the TSP in accordance with the “Tariff Based Competitive Bidding Guidelines for Transmission Service” and “Guidelines for Encouraging Competition in Development of Transmission Projects” issued by Government of India, Ministry of Power under section – 63 of The Electricity Act, 2003 and as amended from time to time. Copy of the Global Invitation for Qualification as published in the newspapers as furnished by BPC is enclosed and marked as **Annexure-4, (Page ...59..... to Page ...59.....)**.





4. That in the RFP documents, the following is stated

Quote

“The Transmission Charges shall be payable by the Designated ISTS Customers in Indian Rupees through the CTU as per Central Electricity Regulatory Commission (Sharing of Inter-State Transmission Charges and Losses) Regulations as amended from time to time..”

Unquote

Copy of the relevant extract of the RFP document issued by the BPC is enclosed and marked as **Annexure-5**, (Page ..60... to Page ..61...) which are integral part of the RFP bidding documents furnished by BPC for bidding.

5. Subsequent to the process of competitive bidding conducted by the BPC, Power Grid Corporation of India Limited has been declared as the successful bidder. Copy of the Certificate by Bid Evaluation Committee report as furnished by BPC is enclosed and marked as **Annexure-6**, (Page ..62... to Page ..63...). The Letter of Intent was issued to Power Grid Corporation of India Limited on 18.09.2024 by the BPC. A copy of the Letter of Intent (LoI) along with the details of Annual Transmission Charges is enclosed and marked as **Annexure-7**, (Page ..63... to Page ...69...).
6. As per the provisions 2.15.2 of Request for Proposal (RFP) and the Letter of Intent issued to Power Grid Corporation of India Limited, within 10 days of issuance of Letter of Intent by the BPC, the Successful Bidder is required to inter-alia provide the Contract Performance Guarantee, execute Share Purchase Agreement & the Transmission Service Agreement and acquire the SPV. Vide letter dated 15.10.2024, the BPC in terms of proviso Clause 2.15.2 of RFP has extended the date upto 22.10.2024 for completion of activities by the successful bidder. A copy of the relevant extract of the RFP and the letter from BPC is enclosed and marked as **Annexure-8**, (Page .....70... to Page ..73...).
7. That in accordance with the LoI, Power Grid Corporation of India Limited on 15.10.2024 furnished Contract Performance Guarantee of Rs 89.00 Crore (Rupees Eighty Nine Crore Only) in favour of Central Transmission Utility of India Limited (CTUIL).
8. A copy of the Transmission Service Agreement (TSA) entered between CTUIL and “**Rajasthan IV H1 Power Transmission Limited**” is enclosed and marked as **Annexure-9**, (Page .....74... to Page ..77...).
9. That the BPC vide letter dated 01.01.2024 had intimated to the bidders that the Acquisition Price payable by the Selected Bidder for Acquisition of one hundred percent of equity shareholding of Rajasthan IV H1 Power Transmission Limited along with all its related assets and liabilities as Rs. 18,38,12,000/-. Subsequent to the bidding and during acquisition the BPC vide letter dated 28.09.2024 intimated

21





the successful bidder - the applicant, the final Acquisition Price as Rs. 18,80,53,596/- with the following break-up:

Professional Fee of BPC # .....Rs. 17,70,00,000/-  
Reimbursement of cos incurred by BPC .....Rs. 1,05,53,596/-  
Share Capital of Rajasthan IV H1 Power Transmission Limited ..Rs. 1,00,000/-

-----  
**Total** **Rs. 18,80,53,596/-**  
-----

That the Acquisition Price intimated earlier was Rs. 18,38,12,000/- (Rs. Eighteen Crore Thirty Eight Lakh Twelve Thousand Only) and the revised Acquisition price intimated after the bidding by the Bid Process Coordinator is Rs. 18,80,53,596/- (Rs. Eighteen Crore Eighty Lakh Fifty Three Thousand Five Hundred Ninety Six Only) which is more than the amount earlier intimated. The aforesaid acquisition price of Rs. 18,80,53,596/- has been paid on 30.09.2024 to the RECPDCL.

A copy of the BPC letters dated 01.01.2024 and 28.09.2024 with regard to the increase in Acquisition Price is enclosed and marked as **Annexure – 10, (Page 225.. to Page 226.)**.

10. Thereafter, Power Grid Corporation of India Limited has acquired the **Rajasthan IV H1 Power Transmission Limited on 15.10.2024** after execution of the Share Purchase Agreement, Transmission Service Agreement and completing all procedural requirements specified in the RFP documents. A copy of the Share purchase agreement is enclosed and marked as **Annexure –11 (Page 227.. to Page 246..)**.

11. The Applicant shall map Nodal Agency i.e. on the e-portal of this Hon'ble Commission at the earliest as per the procedure in vogue and completion of relevant formalities. The Applicant is also sending a copy of the present Application to CTUIL via e-mail. The Application is also being hosted on the website and is accessible on [www.powergrid.in/subsidiaries](http://www.powergrid.in/subsidiaries) and a copy of the Application is marked to CTUIL.

That a copy of the Application is marked to BPC to enable submission of the requisite documents / information by BPC before this Hon'ble Commission regarding the Bidding process undertaken and thereby ensure processing of application.

That a copy of the Application is marked to DICs/beneficiaries of the Western Region as party to the Petition based on the list of the beneficiaries furnished by the CTUIL.

12. That a copy of SLD of the transmission scheme is enclosed and marked as **Annexure –12 (Page 247.. to Page 247..)**.

(22)



an

13. That POWERGRID has acquired the TSP on 15.10.2024 and the same is effective date of the project as per provisions of TSA. The schedule construction period of the project is 24 months. As such Scheduled CoD of the project works out to be 15.10.2026.
14. That **Rajasthan IV H1 Power Transmission Limited** hereby submits this application under Section 63 of the Electricity Act, 2003 for Adoption of Transmission Charges to establish the Project under build, own, operate and transfer basis, which has been determined through transparent process of competitive bidding in accordance with the guidelines issued by the Central Government.
15. It is submitted that Section 63 of the Electricity Act, 2003 empowers the Appropriate Commission for Adoption of Transmission Charges.

Keeping in view the above, Hon'ble Commission may kindly adopt the Transmission Charges with respect to the Transmission System being established by the **Rajasthan IV H1 Power Transmission Limited (a 100% wholly owned subsidiary of Power Grid Corporation of India Limited)**.

#### 16. PRAYER

The applicant hereby humbly prays the Hon'ble Commission to:

- Adoption of Transmission Charges for **Inter-State Transmission System for "Transmission system for evacuation of power from Rajasthan REZ Ph-IV (Part-2 :5.5 GW) (Jaisalmer/ Barmer Complex): Part H1"** discovered through competitive bidding process.
- Allow the sharing and recovery of Transmission Charges for **Inter-State Transmission System for "Transmission system for evacuation of power from Rajasthan REZ Ph-IV (Part-2 :5.5 GW) (Jaisalmer/ Barmer Complex): Part H1"** as per Sharing of Inter-state Transmission Charges and Losses CERC Regulations 2020 and any other amendment thereon issued from time to time by CERC.
- Pass such other order / orders, as may be deemed fit and proper in the facts and circumstances of the case.

**Rajasthan IV H1 Power Transmission Limited**

**Applicant**

  
Represented by Rajendra Kumar Gupta  
Project Incharge, Rajasthan IV H1 Power Transmission Limited

Place: New Delhi

Date: 15/10/2024



23

## MINISTRY OF POWER

## NOTIFICATION

New Delhi, the 29th August, 2023

**S.O. 3894(E).**—In exercise of the powers conferred by sub-para 3.2 of Para 3 of the Guidelines circulated under Section 63 of the Electricity Act, 2003 (no. 36 of 2003), the Central Government, on recommendations of 14<sup>th</sup> meeting of National Committee on Transmission, hereby appoints the following Bid-Process Coordinators (BPCs) for the Transmission Schemes, as shown against the name of the Transmission Schemes: -

Sl. No.	Name & Scope of the Transmission Scheme	Bid Process Coordinator															
1.	<p><b>Transmission System for Evacuation of Power from potential renewable energy zone in Khavda area of Gujarat under Phase-IV (7 GW): Part A</b></p> <p>Tentative Implementation timeframe: 24 months from SPV transfer and matching with Parts B, C &amp; D of Khavda Ph-IV (7 GW)</p> <p><b>Scope:</b></p> <table border="1"> <thead> <tr> <th>Sl. No.</th> <th>Scope of the Transmission Scheme</th> <th>Capacity/ Route length</th> </tr> </thead> <tbody> <tr> <td>1.</td> <td>Creation of 765 kV bus section-II at KPS3 (GIS) along with 765 kV Bus Sectionaliser &amp; 1x330 MVAR, 765 kV Bus Reactors on Bus Section-II</td> <td>Bus Section-II at KPS3 765 kV Bus Sectionaliser – 1 set 1500 MVA, 765/400 kV ICT – 3 Nos. 330 MVAR, 765 kV Bus Reactor – 1 No. 765 kV reactor bay – 1 No. 765 kV ICT bays – 3 Nos.</td> </tr> <tr> <td>2.</td> <td>Creation of 400 kV bus Section-II at KPS3 (GIS) along with 400 kV Bus Sectionaliser &amp; 1x125 MVAR, 420 kV Bus Reactors on Bus Section-II and 3 Nos. 400 kV bays at Bus Section-II for RE interconnection</td> <td>Bus Section-II at KPS3 400 kV Bus Sectionaliser – 1 set 125 MVAR, 420 kV Bus Reactors – 1 No. 400 kV reactor bay – 1 No. 400 kV ICT bays – 3 Nos. (for ICTs at Sl. 1 above) 400 kV line bays – 3 Nos. (for RE interconnection)</td> </tr> <tr> <td>3.</td> <td>KPS3 (GIS) – Lakadia (AIS) 765 kV D/C line</td> <td>Route length: 185 km</td> </tr> <tr> <td>4.</td> <td>2 Nos. of 765 kV line bays each at KPS3 (GIS) &amp; Lakadia (AIS) for KPS3 (GIS) – Lakadia (AIS) 765 kV D/C line</td> <td> <ul style="list-style-type: none"> <li>765 kV line bays (GIS) – 2 Nos. (at KPS3 end Bus Section-II)</li> </ul> </td> </tr> </tbody> </table>	Sl. No.	Scope of the Transmission Scheme	Capacity/ Route length	1.	Creation of 765 kV bus section-II at KPS3 (GIS) along with 765 kV Bus Sectionaliser & 1x330 MVAR, 765 kV Bus Reactors on Bus Section-II	Bus Section-II at KPS3 765 kV Bus Sectionaliser – 1 set 1500 MVA, 765/400 kV ICT – 3 Nos. 330 MVAR, 765 kV Bus Reactor – 1 No. 765 kV reactor bay – 1 No. 765 kV ICT bays – 3 Nos.	2.	Creation of 400 kV bus Section-II at KPS3 (GIS) along with 400 kV Bus Sectionaliser & 1x125 MVAR, 420 kV Bus Reactors on Bus Section-II and 3 Nos. 400 kV bays at Bus Section-II for RE interconnection	Bus Section-II at KPS3 400 kV Bus Sectionaliser – 1 set 125 MVAR, 420 kV Bus Reactors – 1 No. 400 kV reactor bay – 1 No. 400 kV ICT bays – 3 Nos. (for ICTs at Sl. 1 above) 400 kV line bays – 3 Nos. (for RE interconnection)	3.	KPS3 (GIS) – Lakadia (AIS) 765 kV D/C line	Route length: 185 km	4.	2 Nos. of 765 kV line bays each at KPS3 (GIS) & Lakadia (AIS) for KPS3 (GIS) – Lakadia (AIS) 765 kV D/C line	<ul style="list-style-type: none"> <li>765 kV line bays (GIS) – 2 Nos. (at KPS3 end Bus Section-II)</li> </ul>	REC Power Development and Consultancy Limited
Sl. No.	Scope of the Transmission Scheme	Capacity/ Route length															
1.	Creation of 765 kV bus section-II at KPS3 (GIS) along with 765 kV Bus Sectionaliser & 1x330 MVAR, 765 kV Bus Reactors on Bus Section-II	Bus Section-II at KPS3 765 kV Bus Sectionaliser – 1 set 1500 MVA, 765/400 kV ICT – 3 Nos. 330 MVAR, 765 kV Bus Reactor – 1 No. 765 kV reactor bay – 1 No. 765 kV ICT bays – 3 Nos.															
2.	Creation of 400 kV bus Section-II at KPS3 (GIS) along with 400 kV Bus Sectionaliser & 1x125 MVAR, 420 kV Bus Reactors on Bus Section-II and 3 Nos. 400 kV bays at Bus Section-II for RE interconnection	Bus Section-II at KPS3 400 kV Bus Sectionaliser – 1 set 125 MVAR, 420 kV Bus Reactors – 1 No. 400 kV reactor bay – 1 No. 400 kV ICT bays – 3 Nos. (for ICTs at Sl. 1 above) 400 kV line bays – 3 Nos. (for RE interconnection)															
3.	KPS3 (GIS) – Lakadia (AIS) 765 kV D/C line	Route length: 185 km															
4.	2 Nos. of 765 kV line bays each at KPS3 (GIS) & Lakadia (AIS) for KPS3 (GIS) – Lakadia (AIS) 765 kV D/C line	<ul style="list-style-type: none"> <li>765 kV line bays (GIS) – 2 Nos. (at KPS3 end Bus Section-II)</li> </ul>															

ATTESTED TRUE COPY

Attested from Pg 24 - Pg 27

Authorized Signatory  
RAJASTHAN IV HT POWER TRANSMISSION LIMITED



**Note:**

- i. The line lengths mentioned above are approximate as the exact length shall be obtained after the detailed survey
- ii. Developer of Sirohi PS to provide space for 2 Nos. of 765 kV line bays at Sirohi PS along with the space for switchable line reactor.
- iii. Developer of Fatehgarh-III PS (Section-2) to provide space for 2 Nos. of 400 kV line bays at Fatehgarh-III PS (Section-2).
- iv. Switchable line reactors to be implemented with NGR bypass arrangement
- v. Implementation of A, B, C, D, E, F, H1, H2 packages shall be aligned.
- vi. The implementation timeline mentioned above is tentative. Final Timeline would be indicated in the RfP Document.

14.

**Transmission System for Evacuation of Power from Rajasthan REZ Ph-IV (Part-2 : 5.5 GW) (Jaisalmer/Barmer Complex): Part H1**

Tentative Implementation timeframe : 24 months from SPV Transfer

**Scope:**

REC Power Development and Consultancy Limited

Sl. No.	Scope of the Transmission Scheme	Capacity
1.	<p>Establishment of 765/400 kV (2x1500 MVA), 400/22 kV (2x500 MVA) &amp; 220/132 kV (3x200 MVA) Kurawar S/s with 2x330 MVAR 765 kV bus reactor and 1x125 MVAR, 420 kV bus reactor.</p> <p><b>Future Provisions:</b> Space for</p> <ul style="list-style-type: none"> <li>• 765/400 kV ICT along with bays- 4 no.</li> <li>• 765 kV line bays along with switchable line reactors – 8 nos.</li> <li>• 765 kV Bus Reactor along with bay: 2 no.</li> <li>• 765 kV Sectionalizer bay: 1 -set</li> <li>• 400 kV line bays along with switchable line reactor – 8 nos.</li> <li>• 400/220 kV ICT along with bays - 6 nos.</li> <li>• 420 kV Bus Reactor along with bay: 3 nos.</li> <li>• 400 kV Sectionalization bay: 1-set</li> <li>• 220 kV line bays: 12 nos.</li> <li>• 220 kV Sectionalization bay: 1set</li> <li>• 220 kV BC and TBC: 1 no.</li> <li>• 220/132 kV ICT along with bays: 5 Nos.</li> <li>• 132 kV line bays: 16 nos.</li> <li>• 132 kV Sectionalization bay: 1 set</li> </ul>	<ul style="list-style-type: none"> <li>• 765/400 kV, 1500 MVA ICT – 2 (7 single units of 500 MVA including one spare unit)</li> <li>• 400/220 kV, 500 MVA ICT – 2</li> <li>• 220/132 kV, 200 MVA ICT – 3</li> <li>• 765 kV ICT bays- 2</li> <li>• 400 kV ICT bays- 4</li> <li>• 220 kV ICT bays – 5</li> <li>• 132 kV ICT bays - 3</li> <li>• 330 MVAR 765 kV bus reactor-2</li> <li>• 125 MVAR 420 kV bus reactor-1</li> <li>• 765 kV reactor bay- 2</li> <li>• 765 kV line bays- 4</li> <li>• 400 kV line bays- 4</li> <li>• 400 kV reactor bay- 1</li> <li>• 220 kV BC – 1</li> <li>• 220 kV TBC – 1</li> <li>• 132 kV TBC – 1</li> <li>• 110 MVAR, 765 kV, 1-ph reactor (spare unit)-1</li> <li>• 80 MVAR, 765 kV, 1-ph reactor (spare unit)-1</li> </ul>

23





	<ul style="list-style-type: none"> <li>• 132 kV TBC- 1 no.</li> <li>• STATCOM (<math>\pm 300</math> MVAR) along with MSC (<math>2 \times 125</math> MVAR) &amp; MSR (<math>1 \times 125</math> MVAR) along with 400 kV bay.</li> </ul>	
2.	Mandsaur – Kurawar 765 kV D/c line	Route length: 235 km
3.	240 MVAR switchable line reactors on each ckt at both ends of Mandsaur – Kurawar 765 kV D/c line	<ul style="list-style-type: none"> <li>• 240 MVAR, 765 kV switchable line reactor- 4 (2 for Mandsaur end and 2 for Kurawar end)</li> <li>• Switching equipment for 765 kV line reactor- 4 (2 for Mandsaur end and 2 for Kurawar end)</li> </ul>
4.	2 nos. of 765 kV line bays at Mandsaur S/s for termination of Mandsaur – Kurawar 765 kV D/c line	<ul style="list-style-type: none"> <li>• 765 kV line bays – 2 Nos. (for Mandsaur end)</li> </ul>
5.	LILO of Indore – Bhopal 765 kV S/c line at Kurawar	LILO route length: 15 km.
6.	Kurawar – Ashtha 400 kV D/c (Quad ACSR/AAAC/AL59 moose equivalent) line	Route length: 65 km
7.	2 nos. of 400 kV line bays at Ashtha (MP) S/s for termination of Kurawar – Ashtha 400 kV D/c line	400 kV line bays – 2 Nos. [for Ashtha (MP) end]
8.	LILO of one circuit of Indore – Itarsi 400 kV D/c line at Ashtha	LILO route length: 30 km
9.	2 nos. of 400 kV line bays at Ashtha (MP) S/s for LILO of one circuit of Indore – Itarsi 400 kV D/c line at Ashtha	400 kV line bays – 2 Nos. [for Ashtha (MP) end]
10.	Shujalpur – Kurawar 400 kV D/c (Quad ACSR/AAAC/AL59 moose equivalent) line	Route length: 40 km
11.	2 nos. of 400 kV line bays at Shujalpur(PG) S/s for termination of Shujalpur – Kurawar 400 kV D/c line	400 kV line bays – 2 Nos. [for Shujalpur (PG) end]
<p><b>Note:</b></p> <ol style="list-style-type: none"> <li>The line lengths mentioned above are approximate as the exact length shall be obtained after the detailed survey.</li> <li>MPPTCL has confirmed availability of space for 2 nos. 400 kV bays at Ashta (MP) S/s and for 2 nos. additional bays, MPPTCL has informed that adjacent land is private land and may be purchased by the project developer at their cost as per requirement.</li> <li>Implementation of A,B,C,D, E ,F, H1 &amp; H2 packages shall be aligned</li> <li>TSP of the subject scheme shall implement Inter-tripping scheme on Mandsaur – Kurawar 765 kV D/c line (for tripping of the switchable line reactor at Mandsaur/Kurawar end along with the main line breaker).</li> <li>Switchable line reactors to be implemented with NGR bypass arrangement</li> <li>Developer of Mandsaur S/s to provide space for 2 Nos. 765 kV line bays for Mandsaur – Kurawar 765 kV D/c line.</li> </ol>		

26



	<p>vii. POWERGRID to provide space for 2 Nos. 400 kV line bays at Shujalpur S/s for Shujalpur -- Kurawar 400 kV D/c line.</p> <p>viii. The implementation timeline mentioned above is tentative. Final Timeline would be indicated in the RFP Document.</p>	
--	---	--

2. The appointment of the Bid Process Coordinator is subject to the conditions laid down in the Guidelines issued by Ministry of Power in this regard, amended from time to time.

[F. No. 15/3/2018-Trans-Part(1)]  
BIHARI LAL. Under Secy. (Transmission)



27





सत्यमेव जयते

**GOVERNMENT OF INDIA  
MINISTRY OF CORPORATE AFFAIRS**

Central Registration Centre

**Certificate of Incorporation**

[Pursuant to sub-section (2) of section 7 and sub-section (1) of section 8 of the Companies Act, 2013 (18 of 2013) and rule 18 of the Companies (Incorporation) Rules, 2014]

I hereby certify that RAJASTHAN IV H1 POWER TRANSMISSION LIMITED is incorporated on this THIRTEENTH day of OCTOBER TWO THOUSAND TWENTY THREE under the Companies Act, 2013 (18 of 2013) and that the company is Company limited by shares

The Corporate Identity Number of the company is **U42202DL2023GOI421335**

The Permanent Account Number (PAN) of the company is **AANCR0797H\***

The Tax Deduction and Collection Account Number (TAN) of the company is **DELR47344D\***

Given under my hand at Manesar this THIRTEENTH day of OCTOBER TWO THOUSAND TWENTY THREE

Certification signature by DS MINISTRY OF CORPORATE AFFAIRS 10 <roc.crc@mca.gov.in> Validity Unknown

Digitally signed by  
DS MINISTRY OF CORPORATE  
AFFAIRS 10  
Date: 2023.10.14 14:54:02 IST

**SHEETAL KUMARI**

Assistant Registrar of Companies/ Deputy Registrar of Companies/ Registrar of Companies

For and on behalf of the Jurisdictional Registrar of Companies

Registrar of Companies

Central Registration Centre

Disclaimer: This certificate only evidences incorporation of the company on the basis of documents and declarations of the applicant(s). This certificate is neither a license nor permission to conduct business or solicit deposits or funds from public. Permission of sector regulator is necessary wherever required. Registration status and other details of the company can be verified on [mca.gov.in](http://mca.gov.in)

Mailing Address as per record available in Registrar of Companies office:

RAJASTHAN IV H1 POWER TRANSMISSION LIMITED

CORE-4, SCOPE COMPLEX,7, LODHI ROAD,Lodi Road,Delhi,Central Delhi-110003,Delhi

\*as issued by Income tax Department

28



Form No. INC-33



सत्यमेव जयते

Form language

English  Hindi

e-MOA (e-Memorandum of Association)

[Pursuant to Schedule I (see Sections 4 and 5) to the Companies Act, 2013]

Refer instruction kit for filing the form

All fields marked in \* are mandatory

\* Table applicable to company as notified under schedule I of the Companies Act, 2013

(A - MEMORANDUM OF ASSOCIATION OF A COMPANY LIMITED BY SHARES

B - MEMORANDUM OF ASSOCIATION OF A COMPANY LIMITED BY GUARANTEE AND NOT HAVING A SHARE CAPITAL

C - MEMORANDUM OF ASSOCIATION OF A COMPANY LIMITED BY GUARANTEE AND HAVING A SHARE CAPITAL

D - MEMORANDUM OF ASSOCIATION OF AN UNLIMITED COMPANY AND NOT HAVING SHARE CAPITAL

E - MEMORANDUM OF ASSOCIATION OF AN UNLIMITED COMPANY AND HAVING SHARE CAPITAL)

A - MEMORANDUM OF ASSOCIATION OF A COMPANY LIMITED BY SHARES

Table A/B/C/D/E

1 The name of the company is

RAJASTHAN IV H1 POWER TRANSMISSION LIMITED

2 The registered office of the company will be situated in the State of

Delhi

3 (a) The objects to be pursued by the company on its incorporation are:

1. To plan, promote and develop an integrated and efficient power transmission system network in all its aspects including planning, investigation, research, design and engineering, preparation of preliminary, feasibility and definite project reports, construction, operation and maintenance of transmission lines, sub-stations, load dispatch stations and communication facilities and appurtenant works, coordination of integrated operation of regional and national grid system, execution of turn-key jobs for other utilities/organizations and wheeling of power in accordance with the policies, guidelines and objectives laid down by the Central Government from time to time.

2. To study, investigate, collect information and data, review operation, plan, research, design and prepare Report, diagnose operational difficulties and advise on the remedial measures to improve,

ATTESTED TRUE COPY

Attested from Pg 29 - Pg 41

Authorized Signatory  
RAJASTHAN IV H1 POWER TRANSMISSION LIMITED



undertake development of new and innovative product connected with business of the Company as well as modernize existing EHV, HV lines and Sub-Stations.

3.To act as consultants, technical advisors, surveyors and providers of technical and other services to Public or Private Sector enterprises engaged in the planning, investigation, research, design and preparations of preliminary, feasibility and definite project reports, manufacture of power plant and equipment, construction, generation, operation and maintenance of power transmission system from power generating stations and projects, transmission and distribution of power.

4.To plan, promote, develop, erect and maintain, operate and otherwise deal in Telecommunication networks and services in all its aspects including planning, investigation, research, design and engineering, preparation of preliminary, feasibility and definite project reports: to purchase, sell, import, export, assemble, manufacture, install, commission, maintain, operate commercially whether on own or along with other, on lease or otherwise. These networks and for such purposes to set up and/ or install all requisite communications facilities and other facilities including fibre optic links, digital microwave links, communication cables, other telecommunication means, telephone and other exchanges, co-axial stations, microwave stations, repeater stations, security system databases, billing systems, subscriber management systems and other communication systems whether consisting of sound, visual impulse, or otherwise, existing or that may be developed or invented in the future and to manufacture, purchase, sell, import, export, assemble, take or give on lease/rental/subscription

30

basis or by similar means or otherwise deal in all components and other support and ancillary hardware and software systems, accessories, parts and equipments etc. used in or in connection with the operation of the above communication systems and networks including to deal with telecommunication operations or directly with the general public, commercial companies or otherwise.

(b) \*Matters which are necessary for furtherance of the objects specified in clause 3(a) are

- 1.To obtain license, approvals and authorization from Governmental Statutory and Regulatory Authorities, as may be necessary to carry out and achieve the Objects of the Company and connected matters which may seem expedient to develop the business interests of the Company in India and abroad.
- 2.To enter into any arrangement with the Government of India or with any State Government or with other authorities/ commissions, local bodies or public sector or private sector undertakings, Power Utilities, Financial Institutions, Banks, International Funding Agencies and obtain such charters, subsidies, loans, advances or other money, grants, contracts, rights, sanctions, privileges, licenses or concessions whatsoever (whether statutory or otherwise) which the Company may think it desirable to obtain for carrying its activities in furthering the interests of the Company or its members.
- 3.To enter into any agreement, contract or any arrangement for the implementation of the power generation, evacuation, transmission and distribution system and network with Power/ Transmission Utilities, State Electricity Boards, Vidhyut Boards, Transmission Companies, Generation Companies, Licensees, Statutory bodies,

31



other organizations (whether in Private, Public or Joint Sector Undertaking) and bulk consumers of power etc.

4.To secure the payments of money, receivables on transmission and distribution of electricity and sale of fuel, as the case may be, to the State Electricity Boards, Vidyut Boards, Transmission Utilities, Generating Companies, Transmission Companies, Distribution Companies, State Governments, Licensees, statutory bodies, other organizations (whether in Private, Public or Joint Sector Undertaking) and bulk consumers of power etc. through Letter of Credits/ESCROW and other security documents.

5.To coordinate with the Central Transmission Utility of electricity generated by it under the relevant provisions of Electricity Act 2003 and any amendments thereto.

6.Subject to provisions of Sections 73, 74, 179, 180 & 186 and other applicable provisions of the Companies Act, 2013 and rules made thereunder and subject to other laws or directives, if any, of SEBI/RBI, to borrow money in Indian rupees or foreign currencies and obtain foreign lines of credits/ grants/ aids etc. or to receive money or deposits from public for the purpose of the Company's business in such manner and on such terms and with such rights, privileges and obligations as the Company may think fit. The Company may issue bonds/ debentures whether secured or unsecured; bills of exchange, promissory notes or other securities, mortgage or charge on all or any of the immovable and movable properties, present or future and all or any of the uncalled capital for the time being of the Company as the Company may deem fit and To repay, redeem or pay off any such securities or charges.

7.To lend money on property or on mortgage of immovable properties or against Bank

32



guarantee and to make advances of money against future supply of goods and services on such terms as the Directors may consider necessary and to invest money of the Company in such manner as the Directors may think fit and to sell, transfer or to deal with the same.

8.To own, possess, acquire by purchase, lease or otherwise rights, title and interests in and to, exchange or hire real estate, equipment, Transmission lines, lands, buildings, apartments, plants, equipment, machinery, fuel blocks and hereditaments of any tenure or descriptions situated in India or abroad or any estate or interest therein and any right over or connected with land so situated and turn the same to account in any manner as may seem necessary or convenient for the purpose of business of the Company and to hold, improve, exploit, reorganize, manage, lease, sell, exchange or otherwise dispose of the whole or any part thereof.

9.Subject to applicable provisions of Companies Act, 2013, to subscribe for, underwrite, or otherwise acquire, hold, dispose of and deal with the shares, stocks, debentures or other securities and titles of indebtedness or the right to participate in profits or other similar documents issued by any Government authority, Corporation or body or by any company or body of persons and any option or right in respect thereof.

10.To create any depreciation fund, reserve fund, sinking fund, insurance fund, gratuity, provident fund or any other fund, for depreciation or for repairing, improving extending or maintaining any of the properties of the Company or for any other purposes whatsoever conducive to the interests of the Company.

11.To acquire shares, stocks, debentures or securities of any company carrying on an

RS

business which this Company is entitled to carry on or acquisition of undertaking itself which may seem likely or calculated to promote or advance the interests of the Company and to sell or dispose of or transfer any such shares, stocks or securities and the acquired undertaking.

12.To enter into partnership or into any agreement for joint working, sharing or pooling profits, joint venture, amalgamation, union of interests, co-operation, reciprocal concessions or otherwise or amalgamate with any person or company carrying on or engaged in or about to carry on or engaged in any business or transaction in India or abroad which the Company is authorized to carry on or engage in any business undertaking having objects identical or similar to, as are being carried on by this Company.

13.To establish and maintain agencies, branch offices and local agencies, to procure business in any part of India and world and to take such steps as may be necessary to give the Company such rights and privileges in any part of the world as deemed proper in the interest of the Company.

14.To promote and undertake the formation of any institution or Company or subsidiary company or for any aforesaid objects intended to benefit the Company directly or indirectly and to coordinate, control and guide their activities.

15(a).To negotiate and enter into agreements and contracts with domestic and foreign companies, persons or other organizations, banks and financial institutions, in relation to the business of the Company including that of technical know-how, import, export, purchase or sale of plant, machinery, equipment, tools, accessories and consumables, financial assistance and for carrying out all or any of the objects of the Company.

34



15(b). To negotiate and enter into agreements and contracts for execution of turnkey jobs, works, supplies and export of plant, machinery, tools and accessories etc.

16. Upon and for the purpose of any issue of shares, debentures or any other securities of the Company, to enter into agreement with intermediaries including brokers, managers of issue/commission agents and underwriters and to provide for the remuneration of such persons for their services by way of payment in cash or issue of shares, debentures or other securities of the Company or by granting options to take the same or in any other manner as permissible under the law.

17. To enter into contracts of indemnity and get guarantee and allocations for the business of the Company.

18. To make arrangements for training of all categories of employees and to employ or otherwise engage experts, advisors, consultants etc. in the interest of achieving the Company's objects.

19. To promote conservation and protection of electricity from theft, safety of life and to protect environments including air, land and water etc.

20. To pay and provide for the remuneration, amelioration and welfare of persons employed or formerly employed by the Company and their families providing for pension, allowances, bonuses, other payments or by creating for the purpose from time to time the Provident Fund, Gratuity and other Funds or Trusts. Further to undertake building or contributing to the building or houses, dwellings or chawls by grants of money, or by helping persons employed by the Company to effect or maintain insurance on their lives by contributing to the payment of premium or otherwise ~~by~~ providing or subscribing or

35



contributing towards educational institutions, recreation, hospitals and dispensaries, medical and other assistance as the Company may deem fit.

21.To ensure any rights, properties, undertakings, contracts, guarantees or obligations or profits of the Company of every nature and kind in any manner with any person, firm, association, institution or company.

22.To distribute among members of the Company dividend including bonus shares out of profits, accumulated profits or funds and resources of the Company in any manner permissible under law.

23.To institute, conduct, defend, compound or abandon any legal proceedings by or against the Company or its officers or otherwise concerning the affairs of the Company and also to compound and to allow time for payment or satisfaction of any debts or recovery due, claims or demands by or against the Company and to refer any claims or demands by or against the Company or any differences arising in execution of contracts to conciliation and arbitration and to observe, comply with and/or challenge any awards preliminary, interim or final made in any such arbitration.

24.To pay out of the funds of the Company all costs, charges, expenses and preliminary and incidental to the promotion, formation, establishment and registration of the Company or other expenses incurred in this regard.

25.Subject to provisions of Sections 181, 182 & 183 of Companies Act, 2013 to contribute money or otherwise assist to charitable, benevolent, religious, scientific national, defense, public or other institutions or objects or purposes.

26.To open an account or accounts with any individual,

36



firm or company or with any bank bankers or shroofs and to pay into and withdraw money from such account or accounts.

27.To accept gifts, bequests, devises and donations from members and others and to make gifts to members and others of money, assets and properties of any kind.

28.To carry out all or any of the objects of the company and do all or any of the above things in any part of the world and either as principal, agent, contractor or trustee or otherwise and either alone or in conjunction with others.

29.To negotiate and/or enter into agreement and contract with individuals, companies, corporations, foreign or Indian, for obtaining or providing technical, financial or any other assistance for carrying on all or any of the objects of the Company and also for the purpose of activating, research, development of projects on the basis of know-how and/or financial participation and for technical collaboration, and to acquire or provide necessary formulate and patent rights for furthering the objects of the company.

30.To aid peculiarly or otherwise, any association, body or movement having for its object the solution, settlement or surmounting of industrial or labour problems or trouble or the promotion of industry or trade.

31.Subject to the provisions of Companies Act, 2013 or any amendment or re-enactment thereof in the event of winding up to distribute among the members in specie any property of the Company or any proceeds of sale on disposal of any property in accordance with the provisions of the Act.

32.To do all such other things as may be deemed incidental or conducive to the attainment of the above Objects or any of them and to carry on any business which may seem to the

37





capable of being conveniently carried in connection with any of the Company's Objects or calculated directly or indirectly to enhance the value of or render profitable any of the Company's property or rights.

33. To establish, provide, maintain and conduct or otherwise subsidize research laboratories and experimental workshops for scientific, technical or researches, experiments and to undertake and carry on directly or in collaboration with other agencies scientific and technical research experiments and tests of all kinds and to process, improve and invent new products and their techniques of manufacture and to promote, encourage, reward in every manner studies and research, scientific and technical investigations and inventions of any kind that may be considered likely to assist, encourage and promote rapid advances in technology, economies, import substitution or any business which the Company is authorized to carry on.

34. Subject to provisions of the Companies Act, 2013, to evolve scheme for restructuring or arrangement, to amalgamate or merge or to enter into partnership or into any consortium or arrangement for sharing of profits, union of interests, co-operation, joint venture with any Person or Persons, partnership firm/firms, or company or companies carrying on or engaged in any operation capable of being conducted so conveniently in cooperation with the business of the Company or to benefit the Company or to the activities for which the Company has been established.

35. To apply for purchase, or otherwise acquire any trade marks, patents, brevets, inventions, licenses, concessions and the like, conferring any exclusive or nonexclusive or

38



limited rights to use, or any secret or other information as to any invention which may be capable of being used for any of the purposes of the Company, or the acquisition of which may benefit the Company and to use, exercise, develop or grant licenses in respect of or otherwise turn to account the property, rights or information so acquired.

36. To sell, dispose or hive off an undertaking of the Company or any part thereof for such consideration as the Company may think fit and in particular for shares, debentures or securities of any other association, corporation or company.

37. To sell, improve, manage, develop, exchange, loan, lease or let, under-lease, sub - let, mortgage, dispose of, deal with in any manner, turn to account or otherwise deal with any rights or property of the Company.

4 The liability of the member(s) is limited, and this liability is limited to the amount unpaid if any, on the shares held by them.

The liability of the member(s) is limited

The liability of the member(s) is Unlimited

5 Every member of the company undertakes to contribute:

(i) to the assets of the company in the event of its being wound up while he is a member, or within one year after he ceases to be a member, for payment of the debts and liabilities of the company or of such debts and liabilities as may have been contracted before he ceases to be a member; and

(ii) to the costs, charges and expenses of winding up (and for the adjustment of the rights of the contributories among

themselves), such amount as may be required, not exceeding \* \_\_\_\_\_ rupees.

(iii) The share capital of the company is 500000 rupees, divided into

50000	Equity Share	Shares of	10	Rupees each	
-------	--------------	-----------	----	-------------	--

6

We, the several persons, whose names and address are subscribed, are desirous of being formed into a company in pursuance of this memorandum of association, and we respectively agree to take the number of shares in the capital of the company set against our respective names:

39



I, whose name and address is given below, am desirous of forming a company in pursuance of this memorandum of association and agree to take all the shares in the capital of the company:

We, the several persons, whose names and addresses are subscribed, are desirous of being formed into a company in pursuance of this memorandum of association:

**Subscriber Details**

S. No.	*Name, Address, Description and Occupation	DIN / PAN / Passport number	No. of shares taken	DSC	Dated
1	REC POWER DEVELOPMENT AND CONSULTANCY LIMITED, CORE-4, SCOPE COMPLEX, 7, LODHI ROAD, NEW DELHI-110003, THROUGH ITS CEO RAJESH KUMAR S/O SHRINIWAS GUPTA R/O L-187, NAG MANDIR KE PAS SHASTRI NAGAR, ASHOK VIHAR, DELHI-110052, OCCUPATION-SERVICES	06941428	49994 Equity,0 Preference	RAJESH KUMAR	12/10/2023
2	PUTHIYARKATTU SHIVARAMAN HARIHARAN S/O SHRI PUTHIYARAKAT VELAYUDHAN SIVARAMAN NOMINEE OF REC POWER DEVELOPMENT AND CONSULTANCY LIMITED FLAT NO.104, SADAR APARTMENT, MAYUR VIHAR EXTENTION, PHASE-1, PLOT NO.9, NEW DELHI-110091, OCCUPATION-SERVICE	08657652	1 Equity,0 Preference	P S HARIHARAN	12/10/2023
3	MOHAN LAL KUMAWAT S/O SHRI RAMU RAM KUMAWAT NOMINEE OF REC POWER DEVELOPMENT AND CONSULTANCY LIMITED FLAT NO 142 TOWER -1 GC EMERALD, RAMPRASTHA GREENS VAISHALI SECTOR-7, GHAZIABAD-201010, UTTAR PRADESH, OCCUPATION-SERVICE	07682898	1 Equity,0 Preference	Mohan Lal Kumawat	12/10/2023
4	THANGARAJAN BOSH S/O SHRI SITHAN THANGARAJAN NOMINEE OF REC POWER DEVELOPMENT AND CONSULTANCY LIMITE D R/O APARTMENT NO S-2, MIDDLE PORTION 2-B, JANGPURA, MATHURA ROAD, NEW DELHI-110014, OCCUPATION-SERVICE	02772316	1 Equity,0 Preference	Thangarajan Bosh	12/10/2023

40

5	SAHAB NARAIN S/O HARI NARAIN NOMINEE OF REC POWER DEVELOPMENT AND CONSULTANCY LIMITED R/O A-1, FLAT NO 103, SOAMI NAGAR, MALVIYA NAGAR, DELHI-110017, OCCUPATION-SERVICE	03641879	1 Equity,0 Preference	SAHAB NARAIN	12/10/2023
6	ALOK SINGH S/O JAGDHARI SINGH NOMINEE OF REC POWER DEVELOPMENT AND CONSULTANCY LIMITED R/O MF-23, ELDECO MANSIONZ, SECTOR-48, SOHNA ROAD, GURUGRAM - 122018, OCCUPATION- SERVICE	07498786	1 Equity,0 Preference	ALOK SINGH	12/10/2023
7	ARVIND KUMAR S/O NAND KISHOR SINGH NOMINEE OF REC POWER DEVELOPMENT AND CONSULTANCY LIMITED R/O T4-8A, SAI VATIKA APARTMENT, SECTOR-63, FARIDABAD - 121004, OCCUPATION- SERVICE	10342637	1 Equity,0 Preference	ARVIND KUMAR	12/10/2023
<b>Total shares taken</b>			50000 Equity,0 Preference		

**Signed before me**

Membership type of the witness (ACA/FCA/ACS/FCS/ ACMA/FCMA)	*Name of the witness	*Address, Description and Occupation	DIN / PAN / Passport number / Membership number	DSC	Dated
FCA	VINAY KUMAR	1803, TOWER-9, LA RESIDENTIA, TECH ZONE-4, GREATER NOIDA WEST-201306	402996	Vinay Kumar	12/10/2023

7 Shri / Smt

aged

Of

resident of

years shall be the nominee in the event of death of the sole member.



41

Form No. INC-34

e-AOA (e-Articles of Association)

[Pursuant to Section 5 of the Companies Act, 2013 and rules made thereunder read with Schedule I]



Form language

English

Hindi

Refer instruction kit for filing the form.

All fields marked in \* are mandatory

Table applicable to company as notified under schedule I of the Companies Act, 2013 (F, G, H)

Table F / G / H (basis on the selection of above-mentioned field) as notified under schedule I of the companies Act, 2013 is applicable to

(F - a company limited by shares

G - a company limited by guarantee and having a share capital

H - a company limited by guarantee and not having share capital)

F

F - A COMPANY LIMITED BY SHARES

The name of the company is

RAJASTHAN IV H1 POWER TRANSMISSION LIMITED

Check if not applicable	Check if altered	Article No.	Description
			<b>Interpretation</b>
<input type="checkbox"/>	<input checked="" type="checkbox"/>	I	<ul style="list-style-type: none"><li>(1) In these regulations- (a) the Act means the Companies Act 2013 (b) the seal means the common seal of the company. (2) Unless the context otherwise requires words or expressions contained in these regulations shall bear the same meaning as in the Act or any statutory modification thereof in force at the date at which these regulations become binding on the company. (3) Public company means a company which- (a) is not a private company (b) has a minimum paid-up share capital as maybe prescribed Provided that a company which is a subsidiary of a company not being a private company shall be deemed to be public company for the purposes of this Act even where such subsidiary company continues to be a private company in its articles.</li></ul>
			<b>Share Capital and Variation of rights</b>
<input type="checkbox"/>	<input type="checkbox"/>	II 1	<ul style="list-style-type: none"><li>Subject to the provisions of the Act and these Articles the shares in the capital of the company shall be under the control of the Directors who may issue allot or otherwise dispose of the same or any of them to such persons in such proportion and on such terms and conditions and either at a premium or at par and at such time as they may from time to time think fit.</li></ul>
			<ul style="list-style-type: none"><li>Every person whose name is entered as a member in the register</li></ul>

ATTESTED TRUE COPY

Attested from Pg 42 - Pg 58

Authorized Signatory

RAJASTHAN IV H1 POWER TRANSMISSION LIMITED





<input type="checkbox"/>	<input checked="" type="checkbox"/>	2	<p>of members shall be entitled to receive within two months after incorporation in case of subscribers to the memorandum or after allotment or within one month after the application for the registration of transfer or transmission or within such other period as the conditions of issue shall be provided one certificate for all his shares without payment of any charges or several certificates each for one or more of his shares upon payment of twenty rupees for each certificate after the first. Every certificate shall be under theseal and shall specify the shares to which it relates and the amount paid - up thereon. In respect of any share or shares held jointly by several persons the company shall not be bound to issue more than one certificate and delivery of certificate for a share to one of several joint holders shall be sufficient delivery to all such holders.</p>
<input type="checkbox"/>	<input type="checkbox"/>	3	<ul style="list-style-type: none"> <li>If any share certificate be worn out defaced mutilated or torn or if there be no further space on the back for endorsement of transfer then upon production and surrender thereof to the company a new certificate may be issued in lieu thereof and if any certificate is lost or destroyed then upon proof thereof to the satisfaction of the company and on execution of such indemnity as the company deem adequate a new certificate in lieu thereof shall be given. Every certificate under this Article shall be issued on payment of twenty rupees for each certificate. The provisions of Articles (2) and (3) shall mutatis mutandis apply to debentures of the company.</li> </ul>
<input type="checkbox"/>	<input type="checkbox"/>	4	<ul style="list-style-type: none"> <li>Except as required by law no person shall be recognised by the company as holding any share upon any trust and the company shall not be bound by or be compelled in any way to recognise (even when having notice thereof) any equitable contingent future or partial interest in any share or any interest in any fractional part of a share or (except only as by these regulations or by law otherwise provided) any other rights in respect of any share except an absolute right to the entirety thereof in the registered holder.</li> </ul>
<input type="checkbox"/>	<input type="checkbox"/>	5	<ul style="list-style-type: none"> <li>The company may exercise the powers of paying commissions conferred by sub-section (6) of section 40 provided that the rate per cent or the amount of the commission paid or agreed to be paid shall be disclosed in the manner required by that section and rules made thereunder. The rate or amount of the commission shall not exceed the rate or amount prescribed in rules made under sub-section (6) of section 40. The commission may be satisfied by the payment of cash or the allotment of fully or partly paid shares or partly in the one way and partly in the other.</li> </ul>
<input type="checkbox"/>	<input type="checkbox"/>	6	<ul style="list-style-type: none"> <li>If at any time the share capital is divided into different classes of shares the rights attached to any class (unless otherwise provided by the terms of issue of the shares of that class) may subject to the provisions of section 48 and whether or not the company is being wound up be varied with the consent in writing of the holders of three-fourths of the issued shares of that class or with the sanction of a special resolution passed at a separate meeting of the holders of the shares of that class. To every such separate meeting the provisions of these regulations relating to general meetings shall mutatis mutandis apply but so that the necessary quorum shall be at least two persons holding at least one-third of the issued shares</li> </ul>

43



			of the class in question.
<input type="checkbox"/>	<input type="checkbox"/>	7	<ul style="list-style-type: none"> <li>The rights conferred upon the holders of the shares of any class issued with preferred or other rights shall not unless otherwise expressly provided by the terms of issue of the shares of that class be deemed to be varied by the creation or issue of further shares ranking pari passu therewith.</li> </ul>
<input type="checkbox"/>	<input type="checkbox"/>	8	<ul style="list-style-type: none"> <li>Subject to the provisions of section 55 any preference shares may with the sanction of an ordinary resolution be issued on the terms that they are to be redeemed on such terms and in such manner as the company before the issue of the shares may by special resolution determine.</li> </ul>
			<b>Lien</b>
<input type="checkbox"/>	<input type="checkbox"/>	9	<ul style="list-style-type: none"> <li>The company shall have a first and paramount lien on every share (not being a fully paid share) for all monies (whether presently payable or not) called or payable at a fixed time in respect of that share and on all shares (not being fully paid shares) standing registered in the name of a single person for all monies presently payable by him or his estate to the company Provided that the Board of directors may at any time declare any share to be wholly or in part exempt from the provisions of this clause. The company's lien if any on a share shall extend to all dividends payable and bonuses declared from time to time in respect of such shares.</li> </ul>
<input type="checkbox"/>	<input type="checkbox"/>	10	<ul style="list-style-type: none"> <li>The company may sell in such manner as the Board thinks fit any shares on which the company has a lien Provided that no sale shall be made unless a sum in respect of which the lien exists is presently payable or b until the expiration of fourteen days after a notice in writing stating and demanding payment of such part of the amount in respect of which the lien exists as is presently payable has been given to the registered holder for the time being of the share or the person entitled thereto by reason of his death or insolvency.</li> </ul>
<input type="checkbox"/>	<input type="checkbox"/>	11	<ul style="list-style-type: none"> <li>To give effect to any such sale the Board may authorise some person to transfer the shares sold to the purchaser thereof The purchaser shall be registered as the holder of the shares comprised in any such transfer. The purchaser shall not be bound to see to the application of the purchase money nor shall his title to the shares be affected by any irregularity or invalidity in the proceedings in reference to the sale.</li> </ul>
<input type="checkbox"/>	<input type="checkbox"/>	12	<ul style="list-style-type: none"> <li>The proceeds of the sale shall be received by the company and applied in payment of such part of the amount in respect of which the lien exists as is presently payable. The residue if any shall subject to a like lien for sums not presently payable as existed upon the shares before the sale be paid to the person entitled to the shares at the date of the sale.</li> </ul>
			<b>Calls on shares</b>
<input type="checkbox"/>	<input type="checkbox"/>		<ul style="list-style-type: none"> <li>The Board may from time to time make calls upon the members in respect of any monies unpaid on their shares (whether on account</li> </ul>

44



		13	of the nominal value of the shares or by way of premium) and not by the conditions of allotment thereof made payable at fixed times Provided that no call shall exceed one-fourth of the nominal value of the share or be payable at less than one month from the date fixed for the payment of the last preceding call. Each member shall subject to receiving at least fourteen days notice specifying the time or times and place of payment pay to the company at the time or times and place so specified the amount called on his shares. A call may be revoked or postponed at the discretion of the Board.
<input type="checkbox"/>	<input type="checkbox"/>	14	<ul style="list-style-type: none"> <li>A call shall be deemed to have been made at the time when the resolution of the Board authorizing the call was passed and may be required to be paid by instalments.</li> </ul>
<input type="checkbox"/>	<input type="checkbox"/>	15	<ul style="list-style-type: none"> <li>The joint holders of a share shall be jointly and severally liable to pay all calls in respect thereof.</li> </ul>
<input type="checkbox"/>	<input type="checkbox"/>	16	<ul style="list-style-type: none"> <li>If a sum called in respect of a share is not paid before or on the day appointed for payment thereof the person from whom the sum is due shall pay interest thereon from the day appointed for payment thereof to the time of actual payment at ten per cent per annum or at such lower rate if any as the Board may determine. The Board shall be at liberty to waive payment of any such interest wholly or in part.</li> </ul>
<input type="checkbox"/>	<input type="checkbox"/>	17	<ul style="list-style-type: none"> <li>Any sum which by the terms of issue of a share becomes payable on allotment or at any fixed date whether on account of the nominal value of the share or by way of premium shall for the purposes of these regulations be deemed to be a call duly made and payable on the date on which by the terms of issue such sum becomes payable. In case of non-payment of such sum all the relevant provisions of these regulations as to payment of interest and expenses forfeiture or otherwise shall apply as if such sum had become payable by virtue of a call duly made and notified.</li> </ul>
<input type="checkbox"/>	<input type="checkbox"/>	18	<ul style="list-style-type: none"> <li>The Board - a. may if it thinks fit receive from any member willing to advance the same all or any part of the monies uncalled and unpaid upon any shares held by him and b. upon all or any of the monies so advanced may (until the same would but for such advance become presently payable) pay interest at such rate not exceeding unless the company in general meeting shall otherwise direct twelve per cent per annum as may be agreed upon between the Board and the member paying the sum in advance.</li> </ul>
			<b>Transfer of shares</b>
<input type="checkbox"/>	<input type="checkbox"/>	19	<ul style="list-style-type: none"> <li>The instrument of transfer of any share in the company shall be executed by or on behalf of both the transferor and transferee. The transferor shall be deemed to remain a holder of the share until the name of the transferee is entered in the register of members in respect thereof.</li> </ul>
<input type="checkbox"/>	<input type="checkbox"/>	20	<ul style="list-style-type: none"> <li>The Board may subject to the right of appeal conferred by section 58 decline to register the transfer of a share not being a fully paid share to a person of whom they do not approve or any transfer of</li> </ul>

45



			shares on which the company has a lien.
<input type="checkbox"/>	<input type="checkbox"/>	21	<ul style="list-style-type: none"> <li>The Board may decline to recognise any instrument of transfer unless the instrument of transfer is in the form as prescribed in rules made under sub-section (1) of section 56b. the instrument of transfer is accompanied by the certificate of the shares to which it relates and such other evidence as the Board may reasonably require to show the right of the transferor to make the transfer and c. the instrument of transfer is in respect of only one class of shares.</li> </ul>
<input type="checkbox"/>	<input type="checkbox"/>	22	<ul style="list-style-type: none"> <li>On giving not less than seven days previous notice in accordance with section 91 and rules made thereunder the registration of transfers may be suspended at such times and for such periods as the Board may from time to time determine Provided that such registration shall not be suspended for more than thirty days at any one time or for more than forty-five days in the aggregate in any year.</li> </ul>
			<b>Transmission of shares</b>
<input type="checkbox"/>	<input type="checkbox"/>	23	<ul style="list-style-type: none"> <li>On the death of a member the survivor or survivors where the member was a joint holder and his nominee or nominees or legal representatives where he was a sole holder shall be the only persons recognised by the company as having any title to his interest in the shares Nothing in clause (i) shall release the estate of a deceased joint holder from any liability in respect of any share which had been jointly held by him with other persons.</li> </ul>
<input type="checkbox"/>	<input type="checkbox"/>	24	<ul style="list-style-type: none"> <li>Any person becoming entitled to a share in consequence of the death or insolvency of a member may upon such evidence being produced as may from time to time properly be required by the Board and subject as hereinafter provided elect either to be registered himself as holder of the share or to make such transfer of the share as the deceased or insolvent member could have made. The Board shall in either case have the same right to decline or suspend registration as it would have had if the deceased or insolvent member had transferred the share before his death or insolvency.</li> </ul>
<input type="checkbox"/>	<input type="checkbox"/>	25	<ul style="list-style-type: none"> <li>If the person so becoming entitled shall elect to be registered as holder of the share himself he shall deliver or send to the company a notice in writing signed by him stating that he so elects. If the person aforesaid shall elect to transfer the share he shall testify his election by executing a transfer of the share. All the limitations restrictions and provisions of these regulations relating to the right to transfer and the registration of transfers of shares shall be applicable to any such notice or transfer as aforesaid as if the death or insolvency of the member had not occurred and the notice or transfer were a transfer signed by that member.</li> </ul>
<input type="checkbox"/>	<input type="checkbox"/>		<ul style="list-style-type: none"> <li>A person becoming entitled to a share by reason of the death or insolvency of the holder shall be entitled to the same dividends and other advantages to which he would be entitled if he were the registered holder of the share except that he shall not before being registered as a member in respect of the share be entitled in</li> </ul>

46





		26	respect of it to exercise any right conferred by membership in relation to meetings of the company Provided that the Board may at any time give notice requiring any such person to elect either to be registered himself or to transfer the share and if the notice is not complied with within ninety days the Board may thereafter withhold payment of all dividends bonuses or other monies payable in respect of the share until the requirements of the notice have been complied with.
<input checked="" type="checkbox"/>	<input type="checkbox"/>	27	<ul style="list-style-type: none"> <li>In case of a One Person Company on the death of the sole member the person nominated by such member shall be the person recognised by the company as having title to all the shares of the member the nominee on becoming entitled to such shares in case of the members death shall be informed of such event by the Board of the company such nominee shall be entitled to the same dividends and other rights and liabilities to which such sole member of the company was entitled or liable on becoming member such nominee shall nominate any other person with the prior written consent of such person who shall in the event of the death of the member become the member of the company.</li> </ul>
			<b>Forfeiture of shares</b>
<input type="checkbox"/>	<input type="checkbox"/>	28	<ul style="list-style-type: none"> <li>If a member fails to pay any call or instalment of a call on the day appointed for payment thereof the Board may at any time thereafter during such time as any part of the call or instalment remains unpaid serve a notice on him requiring payment of so much of the call or instalment as is unpaid together with any interest which may have accrued.</li> </ul>
<input type="checkbox"/>	<input type="checkbox"/>	29	<ul style="list-style-type: none"> <li>The notice aforesaid shall name a further day (not being earlier than the expiry of fourteen days from the date of service of the notice) on or before which the payment required by the notice is to be made and state that in the event of non-payment on or before the day so named the shares in respect of which the call was made shall be liable to be forfeited.</li> </ul>
<input type="checkbox"/>	<input type="checkbox"/>	30	<ul style="list-style-type: none"> <li>If the requirements of any such notice as aforesaid are not complied with any share in respect of which the notice has been given may at any time thereafter before the payment required by the notice has been made be forfeited by a resolution of the Board to that effect.</li> </ul>
<input type="checkbox"/>	<input type="checkbox"/>	31	<ul style="list-style-type: none"> <li>A forfeited share may be sold or otherwise disposed of on such terms and in such manner as the Board thinks fit. At any time before a sale or disposal as aforesaid the Board may cancel the forfeiture on such terms as it thinks fit.</li> </ul>
<input type="checkbox"/>	<input type="checkbox"/>	32	<ul style="list-style-type: none"> <li>A person whose shares have been forfeited shall cease to be a member in respect of the forfeited shares but shall notwithstanding the forfeiture remain liable to pay to the company all monies which at the date of forfeiture were presently payable by him to the company in respect of the shares. The liability of such person shall cease if and when the company shall have received payment in full of all such monies in respect of the shares.</li> </ul>
			<ul style="list-style-type: none"> <li>A duly verified declaration in writing that the declarant is a director</li> </ul>

*(Handwritten signature)*





<input type="checkbox"/>	<input type="checkbox"/>	33	<p>the manager or the secretary of the company and that a share in the company has been duly forfeited on a date stated in the declaration shall be conclusive evidence of the facts therein stated as against all persons claiming to be entitled to the share The company may receive the consideration if any given for the share on any sale or disposal thereof and may execute a transfer of the share in favour of the person to whom the share is sold or disposed of The transferee shall thereupon be registered as the holder of the share and The transferee shall not be bound to see to the application of the purchase money if any nor shall his title to the share be affected by any irregularity or invalidity in the proceedings in reference to the forfeiture sale or disposal of the share.</p>
<input type="checkbox"/>	<input type="checkbox"/>	34	<ul style="list-style-type: none"> <li>The provisions of these regulations as to forfeiture shall apply in the case of non-payment of any sum which by the terms of issue of a share becomes payable at a fixed time whether on account of the nominal value of the share or by way of premium as if the same had been payable by virtue of a call duly made and notified.</li> </ul>
			<p><b>Alteration of capital</b></p>
<input type="checkbox"/>	<input type="checkbox"/>	35	<ul style="list-style-type: none"> <li>The company may from time to time by ordinary resolution increase the share capital by such sum to be divided into shares of such amount as may be specified in the resolution.</li> </ul>
<input type="checkbox"/>	<input type="checkbox"/>	36	<ul style="list-style-type: none"> <li>Subject to the provisions of section 61 the company may by ordinary resolution consolidate and divide all or any of its share capital into shares of larger amount than its existing shares convert all or any of its fully paid-up shares into stock and reconvert that stock into fully paid-up shares of any denomination sub-divide its existing shares or any of them into shares of smaller amount than is fixed by the memorandum cancel any shares which at the date of the passing of the resolution have not been taken or agreed to be taken by any person.</li> </ul>
<input type="checkbox"/>	<input type="checkbox"/>	37	<ul style="list-style-type: none"> <li>Where shares are converted into stock the holders of stock may transfer the same or any part thereof in the same manner as and subject to the same regulations under which the shares from which the stock arose might before the conversion have been transferred or as near thereto as circumstances admit Provided that the Board may from time to time fix the minimum amount of stock transferable so however that such minimum shall not exceed the nominal amount of the shares from which the stock arose. the holders of stock shall according to the amount of stock held by them have the same rights privileges and advantages as regards dividends voting at meetings of the company and other matters as if they held the shares from which the stock arose but no such privilege or advantage (except participation in the dividends and profits of the company and in the assets on winding up) shall be conferred by an amount of stock which would not if existing in shares have conferred that privilege or advantage. such of the regulations of the company as are applicable to paid-up shares shall apply to stock and the words share and shareholder in those regulations shall include stock and stock-holder respectively.</li> </ul>

48



<input type="checkbox"/>	<input type="checkbox"/>	38	<ul style="list-style-type: none"> <li>The company may by special resolution reduce in any manner and with and subject to any incident authorised and consent required by law its share capital any capital redemption reserve account or any share premium account.</li> </ul>
			<b>Capitalisation of profits</b>
<input type="checkbox"/>	<input type="checkbox"/>	39	<ul style="list-style-type: none"> <li>The company in general meeting may upon the recommendation of the Board resolve that it is desirable to capitalise any part of the amount for the time being standing to the credit of any of the company's reserve accounts or to the credit of the profit and loss account or otherwise available for distribution and that such sum be accordingly set free for distribution in the manner specified in clause (ii) amongst the members who would have been entitled thereto if distributed by way of dividend and in the same proportions. The sum aforesaid shall not be paid in cash but shall be applied subject to the provision contained in clause (iii) either in or towards paying up any amounts for the time being unpaid on any shares held by such members respectively paying up in full unissued shares of the company to be allotted and distributed credited as fully paid-up to and amongst such members in the proportions aforesaid partly in the way specified in sub-clause (A) and partly in that specified in sub-clause (B) A securities premium account and a capital redemption reserve account may for the purposes of this regulation be applied in the paying up of unissued shares to be issued to members of the company as fully paid bonus shares The Board shall give effect to the resolution passed by the company in pursuance of this regulation.</li> </ul>
<input type="checkbox"/>	<input type="checkbox"/>	40	<ul style="list-style-type: none"> <li>Whenever such a resolution as aforesaid shall have been passed the Board shall make all appropriations and applications of the undivided profits resolved to be capitalised thereby and all allotments and issues of fully paid shares if any and generally do all acts and things required to give effect thereto. The Board shall have power to make such provisions by the issue of fractional certificates or by payment in cash or otherwise as it thinks fit for the case of shares becoming distributable in fractions and to authorise any person to enter on behalf of all the members entitled thereto into an agreement with the company providing for the allotment to them respectively credited as fully paid-up of any further shares to which they may be entitled upon such capitalisation or as the case may require for the payment by the company on their behalf by the application thereto of their respective proportions of profits resolved to be capitalised of the amount or any part of the amounts remaining unpaid on their existing shares Any agreement made under such authority shall be effective and binding on such members</li> </ul>
			<b>Buy-back of shares</b>
<input type="checkbox"/>	<input type="checkbox"/>	41	<ul style="list-style-type: none"> <li>Notwithstanding anything contained in these articles but subject to the provisions of sections 68 to 70 and any other applicable provision of the Act or any other law for the time being in force the company may purchase its own shares or other specified securities.</li> </ul>

49



			<b>General meetings</b>
<input type="checkbox"/>	<input type="checkbox"/>	42	<ul style="list-style-type: none"> <li>All general meetings other than annual general meeting shall be called extraordinary general meeting.</li> </ul>
<input type="checkbox"/>	<input type="checkbox"/>	43	<ul style="list-style-type: none"> <li>The Board may whenever it thinks fit call an extraordinary general meeting. If at any time directors capable of acting who are sufficient in number to form a quorum are not within India any director or any two members of the company may call an extraordinary general meeting in the same manner as nearly as possible as that in which such a meeting may be called by the Board.</li> </ul>
			<b>Proceedings at general meetings</b>
<input type="checkbox"/>	<input type="checkbox"/>	44	<ul style="list-style-type: none"> <li>No business shall be transacted at any general meeting unless a quorum of members is present at the time when the meeting proceeds to business. Save as otherwise provided herein the quorum for the general meetings shall be as provided in section 103.</li> </ul>
<input type="checkbox"/>	<input type="checkbox"/>	45	<ul style="list-style-type: none"> <li>The chairperson if any of the Board shall preside as Chairperson at every general meeting of the company.</li> </ul>
<input type="checkbox"/>	<input type="checkbox"/>	46	<ul style="list-style-type: none"> <li>If there is no such Chairperson or if he is not present within fifteen minutes after the time appointed for holding the meeting or is unwilling to act as chairperson of the meeting the directors present shall elect one of their members to be Chairperson of the meeting.</li> </ul>
<input type="checkbox"/>	<input type="checkbox"/>	47	<ul style="list-style-type: none"> <li>If at any meeting no director is willing to act as Chairperson or if no director is present within fifteen minutes after the time appointed for holding the meeting the members present shall choose one of their members to be Chairperson of the meeting.</li> </ul>
<input checked="" type="checkbox"/>	<input type="checkbox"/>	48	<ul style="list-style-type: none"> <li>In case of a One Person Company the resolution required to be passed at the general meetings of the company shall be deemed to have been passed if the resolution is agreed upon by the sole member and communicated to the company and entered in the minutes book maintained under section 118 such minutes book shall be signed and dated by the member the resolution shall become effective from the date of signing such minutes by the sole member.</li> </ul>
			<b>Adjournment of meeting</b>
<input type="checkbox"/>	<input type="checkbox"/>	49	<ul style="list-style-type: none"> <li>The Chairperson may with the consent of any meeting at which a quorum is present and shall if so directed by the meeting adjourn the meeting from time to time and from place to place. No business shall be transacted at any adjourned meeting other than the business left unfinished at the meeting from which the adjournment took place. When a meeting is adjourned for thirty days or more notice of the adjourned meeting shall be given as in the case of an original meeting. Save as aforesaid and as provided in section 103 of the Act it shall not be necessary to give any notice of an adjournment or of the business to be transacted at an</li> </ul>

50

			adjourned meeting.
			<b>Voting rights</b>
<input type="checkbox"/>	<input type="checkbox"/>	50	<ul style="list-style-type: none"> <li>Subject to any rights or restrictions for the time being attached to any class or classes of shares on a show of hands every member present in person shall have one vote and on a poll the voting rights of members shall be in proportion to his share in the paid-up equity share capital of the company.</li> </ul>
<input type="checkbox"/>	<input type="checkbox"/>	51	<ul style="list-style-type: none"> <li>A member may exercise his vote at a meeting by electronic means in accordance with section 108 and shall vote only once.</li> </ul>
<input type="checkbox"/>	<input type="checkbox"/>	52	<ul style="list-style-type: none"> <li>In the case of joint holders the vote of the senior who tenders a vote whether in person or by proxy shall be accepted to the exclusion of the votes of the other joint holders. For this purpose seniority shall be determined by the order in which the names stand in the register of members.</li> </ul>
<input type="checkbox"/>	<input type="checkbox"/>	53	<ul style="list-style-type: none"> <li>A member of unsound mind or in respect of whom an order has been made by any court having jurisdiction in lunacy may vote whether on a show of hands or on a poll by his committee or other legal guardian and any such committee or guardian may on a poll vote by proxy.</li> </ul>
<input type="checkbox"/>	<input type="checkbox"/>	54	<ul style="list-style-type: none"> <li>Any business other than that upon which a poll has been demanded maybe proceeded with pending the taking of the poll.</li> </ul>
<input type="checkbox"/>	<input type="checkbox"/>	55	<ul style="list-style-type: none"> <li>No member shall be entitled to vote at any general meeting unless all calls or other sums presently payable by him in respect of shares in the company have been paid</li> </ul>
<input type="checkbox"/>	<input type="checkbox"/>	56	<ul style="list-style-type: none"> <li>No objection shall be raised to the qualification of any voter except at the meeting or adjourned meeting at which the vote objected to is given or tendered and every vote not disallowed at such meeting shall be valid for all purposes. Any such objection made in due time shall be referred to the Chairperson of the meeting whose decision shall be final and conclusive.</li> </ul>
			<b>Proxy</b>
<input type="checkbox"/>	<input type="checkbox"/>	57	<ul style="list-style-type: none"> <li>The instrument appointing a proxy and the power-of-attorney or other authority if any under which it is signed or a notarised copy of that power or authority shall be deposited at the registered office of the company not less than 48 hours before the time for holding the meeting or adjourned meeting at which the person named in the instrument proposes to vote or in the case of a poll not less than 24 hours before the time appointed for the taking of the poll and in default the instrument of proxy shall not be treated as valid.</li> </ul>
<input type="checkbox"/>	<input type="checkbox"/>	58	<ul style="list-style-type: none"> <li>An instrument appointing a proxy shall be in the form as prescribed in the rules made under section 105</li> </ul>
<input type="checkbox"/>	<input type="checkbox"/>		<ul style="list-style-type: none"> <li>A vote given in accordance with the terms of an instrument of proxy shall be valid notwithstanding the previous death or insanity</li> </ul>

15





	59	of the principal or the revocation of the proxy or of the authority under which the proxy was executed or the transfer of the shares in respect of which the proxy is given Provided that no intimation in writing of such death insanity revocation or transfer shall have been received by the company at its office before the commencement of the meeting or adjourned meeting at which the proxy is used.
		<b>Board of Directors</b>
<input type="checkbox"/>	<input checked="" type="checkbox"/>	<p>60</p> <ul style="list-style-type: none"> <li>The day to day management of the business of the Company shall be vested with the Board of Directors of the Company or such persons as may be authorized by the Board from time to time. The Board may exercise all such powers of the Company and do all such acts, deeds and things as are not prohibited by the Act or any other law for the time being in force or by the Memorandum of Association of the Company and without prejudice to the foregoing shall be responsible for all policy matters and the supervision, direction and control of the conduct of the business affairs and operations of the Company. The first Directors of the Company shall be 1. KUNTALA VENU GOPAL 2. DEBASIS MITRA 3. AWANISH KUMAR BHARATI iia every annual general meeting One third of such of the directors for the time being as are liable to retire by rotation or if their number is neither three nor a multiple of three then the number nearest to one third shall retire from office. The directors to retire by rotation at every annual general meeting shall be those who have been longest in office since their last appointment but as between persons who became directors on the same day those who are to retire shall in default of and subject to any subject to any agreement among themselves be determined by lot at annual general meeting at which a director retires as afore said the company may fill up the vacancy by appointing there to a director or some other person there to. The Board of Directors of the Company shall consist of not less than but not more than Directors. The appointment of Directors including the Chairman, Managing Director, Whole time Director, Part time Director shall be done in the General Meetings in accordance with the provisions of the Companies Act and Rules made there under and shall be eligible for appointment. However till the Company is a Government Company REC Power Development and Consultancy Limited RECPDCL the holding company shall have the full powers to recommend/nominate the name of any Directors to be appointed on the Board of the Company. Further RECPDCL shall also have the power to remove any director from office at any time in its absolute discretion. RECPDCL shall also have the right to fill any vacancies in the office of director caused by removal, resignation, death or otherwise. Subject to provisions of the Act the Company may by passing a resolution in General Meeting increase or decrease the maximum number of Directors and may alter their qualification. Further the Company may subject to the provisions of the Act remove any Director before the expiration of his period of office and appoint another person in place of him. The Board may appoint any person to act as alternate director for a Director during the later absence for a period of not less than three months from India and such appointment shall have effect and such appointee whilst he holds office as an alternate director shall be entitled to notice of meeting of the Board and to attend and vote there at accordingly but he shall not require any qualification and shall ipso facto vacate office if and when the absent Director returns to India.</li> </ul>

52



			Casual vacancies among Directors may be filled by the Board of Directors at their meeting and any person so appointed shall hold the office as per the provision of section of the Act Subject to the provisions of Section and other applicable provisions if any of the Act the Board shall have power at any time and from time to time to appoint a person as an Additional Director but so that the total number of Directors shall not at any time exceed the maximum number fixed by these Articles The Additional Director so appointed shall retire from Office at next annual General Meeting but shall be eligible for election by the company at that meeting as a Director
<input type="checkbox"/>	<input type="checkbox"/>	61	<ul style="list-style-type: none"> <li>The remuneration of the directors shall in so far as it consists of a monthly payment be deemed to accrue from day-to-day. In addition to the remuneration payable to them in pursuance of the Act the directors may be paid all travelling hotel and other expenses properly incurred by them in attending and returning from meetings of the Board of Directors or any committee thereof or general meetings of the company or in connection with the business of the company.</li> </ul>
<input type="checkbox"/>	<input type="checkbox"/>	62	<ul style="list-style-type: none"> <li>The Board may pay all expenses incurred in getting up and registering the company.</li> </ul>
<input type="checkbox"/>	<input type="checkbox"/>	63	<ul style="list-style-type: none"> <li>The company may exercise the powers conferred on it by section 88 with regard to the keeping of a foreign register and the Board may (subject to the provisions of that section) make and vary such regulations as it may think fit respecting the keeping of any such register.</li> </ul>
<input type="checkbox"/>	<input type="checkbox"/>	64	<ul style="list-style-type: none"> <li>All cheques promissory notes drafts hundis bills of exchange and other negotiable instruments and all receipts for monies paid to the company shall be signed drawn accepted endorsed or otherwise executed as the case may be by such person and in such manner as the Board shall from time to time by resolution determine</li> </ul>
<input type="checkbox"/>	<input type="checkbox"/>	65	<ul style="list-style-type: none"> <li>Every director present at any meeting of the Board or of a committee thereof shall sign his name in a book to be kept for that purpose.</li> </ul>
<input type="checkbox"/>	<input type="checkbox"/>	66	<ul style="list-style-type: none"> <li>Subject to the provisions of section 149 the Board shall have power at any time and from time to time to appoint a person as an additional director provided the number of the directors and additional directors together shall not at any time exceed the maximum strength fixed for the Board by the articles. Such person shall hold office only up to the date of the next annual general meeting of the company but shall be eligible for appointment by the company as a director at that meeting subject to the provisions of the Act.</li> </ul>
			<b>Proceedings of the Board</b>
<input type="checkbox"/>	<input type="checkbox"/>	67	<ul style="list-style-type: none"> <li>The Board of Directors may meet for the conduct of business adjourn and otherwise regulate its meetings as it thinks fit. A director may and the manager or secretary on the requisition of a director shall at any time summon a meeting of the Board.</li> </ul>







			signing such minutes by the director.
			<b>Chief Executive Officer, Manager, Company Secretary or Chief Financial Officer</b>
<input type="checkbox"/>	<input type="checkbox"/>	77	<ul style="list-style-type: none"> <li>Subject to the provisions of the Act A chief executive officer manager company secretary or chief financial officer may be appointed by the Board for such term at such remuneration and upon such conditions as it may think fit and any chief executive officer manager company secretary or chief financial officer so appointed may be removed by means of a resolution of the Board A director may be appointed as chief executive officer manager company secretary or chief financial officer</li> </ul>
<input type="checkbox"/>	<input type="checkbox"/>	78	<ul style="list-style-type: none"> <li>A provision of the Act or these regulations requiring or authorising a thing to be done by or to a director and chief executive officer manager company secretary or chief financial officer shall not be satisfied by its being done by or to the same person acting both as director and as or in place of chief executive officer manager company secretary or chief financial officer.</li> </ul>
			<b>The Seal</b>
<input type="checkbox"/>	<input type="checkbox"/>	79	<ul style="list-style-type: none"> <li>The Board shall provide for the safe custody of the seal. The seal of the company shall not be affixed to any instrument except by the authority of a resolution of the Board or of a committee of the Board authorised by it in that behalf and except in the presence of at least two directors and of the secretary or such other person as the Board may appoint for the purpose and those two directors and the secretary or other person aforesaid shall sign every instrument to which the seal of the company is so affixed in their presence.</li> </ul>
			<b>Dividends and Reserve</b>
<input type="checkbox"/>	<input type="checkbox"/>	80	<ul style="list-style-type: none"> <li>The company in general meeting may declare dividends but no dividend shall exceed the amount recommended by the Board.</li> </ul>
<input type="checkbox"/>	<input type="checkbox"/>	81	<ul style="list-style-type: none"> <li>Subject to the provisions of section 123 the Board may from time to time pay to the members such interim dividends as appear to it to be justified by the profits of the company.</li> </ul>
<input type="checkbox"/>	<input type="checkbox"/>	82	<ul style="list-style-type: none"> <li>The Board may before recommending any dividend set aside out of the profits of the company such sums as it thinks fit as a reserve or reserves which shall at the discretion of the Board be applicable for any purpose to which the profits of the company may be properly applied including provision for meeting contingencies or for equalizing dividends and pending such application may at the like discretion either be employed in the business of the company or be invested in such investments (other than shares of the company) as the Board may from time to time think fit. The Board may also carry forward any profits which it may consider necessary not to divide without setting them aside as a reserve</li> </ul>
<input type="checkbox"/>	<input type="checkbox"/>		<ul style="list-style-type: none"> <li>Subject to the rights of persons if any entitled to shares with special rights as to dividends all dividends shall be declared and paid according to the amounts paid or credited as paid on the shares in</li> </ul>

55



		83	<p>respect whereof the dividend is paid but if and so long as nothing is paid upon any of the shares in the company dividends may be declared and paid according to the amounts of the shares. No amount paid or credited as paid on a share in advance of calls shall be treated for the purposes of this regulation as paid on the share. All dividends shall be apportioned and paid proportionately to the amounts paid or credited as paid on the shares during any portion or portions of the period in respect of which the dividend is paid but if any share is issued on terms providing that it shall rank for dividend as from a particular date such share shall rank for dividend accordingly.</p>
<input type="checkbox"/>	<input type="checkbox"/>	84	<ul style="list-style-type: none"> <li>The Board may deduct from any dividend payable to any member all sums of money if any presently payable by him to the company on account of calls or otherwise in relation to the shares of the company.</li> </ul>
<input type="checkbox"/>	<input type="checkbox"/>	85	<ul style="list-style-type: none"> <li>Any dividend interest or other monies payable in cash in respect of shares may be paid by cheque or warrant sent through the post directed to the registered address of the holder or in the case of joint holders to the registered address of that one of the joint holders who is first named on the register of members or to such person and to such address as the holder or joint holders may in writing direct. Every such cheque or warrant shall be made payable to the order of the person to whom it is sent.</li> </ul>
<input type="checkbox"/>	<input type="checkbox"/>	86	<ul style="list-style-type: none"> <li>Any one of two or more joint holders of a share may give effective receipts for any dividends bonuses or other monies payable in respect of such share.</li> </ul>
<input type="checkbox"/>	<input type="checkbox"/>	87	<ul style="list-style-type: none"> <li>Notice of any dividend that may have been declared shall be given to the persons entitled to share therein in the manner mentioned in the Act.</li> </ul>
<input type="checkbox"/>	<input type="checkbox"/>	88	<ul style="list-style-type: none"> <li>No dividend shall bear interest against the company.</li> </ul>
			<b>Accounts</b>
<input type="checkbox"/>	<input type="checkbox"/>	89	<ul style="list-style-type: none"> <li>The Board shall from time to time determine whether and to what extent and at what times and places and under what conditions or regulations the accounts and books of the company or any of them shall be open to the inspection of members not being directors. No member (not being a director) shall have any right of inspecting any account or book or document of the company except as conferred by law or authorised by the Board or by the company in general meeting.</li> </ul>
			<b>Winding up</b>
<input type="checkbox"/>	<input type="checkbox"/>		<ul style="list-style-type: none"> <li>Subject to the provisions of Chapter XX of the Act and rules made thereunder if the company shall be wound up the liquidator may with the sanction of a special resolution of the company and any other sanction required by the Act divide amongst the members in specie or kind the whole or any part of the assets of the company whether they shall consist of property of the same kind or not. For the purpose aforesaid the liquidator may set such value as he</li> </ul>

56



		90	deems fair upon any property to be divided as aforesaid and may determine how such division shall be carried out as between the members or different classes of members. The liquidator may with the like sanction vest the whole or any part of such assets in trustees upon such trusts for the benefit of the contributories if he considers necessary but so that no member shall be compelled to accept any shares or other securities whereon there is any liability.
			<b>Indemnity</b>
┌	┌	91	<ul style="list-style-type: none"> <li>Every officer of the company shall be indemnified out of the assets of the company against any liability incurred by him in defending any proceedings whether civil or criminal in which judgment is given in his favour or in which he is acquitted or in which relief is granted to him by the court or the Tribunal.</li> </ul>
			<b>Others</b>
┌	┌	92	•

#### Subscriber Details

S. No.	Subscriber Details				
	*Name, Address, Description and Occupation	DIN / PAN / Passport number	*Place	DSC	Dated
1	REC POWER DEVELOPMENT AND CONSULTANCY LIMITED, CORE-4, SCOPE COMPLEX, 7, LODHI ROAD, NEW DELHI-110003, THROUGH ITS CEO RAJESH KUMAR S/O SHRINIWAS GUPTA R/O L-187, NAG MANDIR KE PAS SHASTRI NAGAR, ASHOK VIHAR, DELHI-110052, OCCUPATION-SERVICES	06941428	NEW DELHI	RAJESH KUMAR	12/10/2023
2	SAHAB NARAIN S/O HARI NARAIN NOMINEE OF REC POWER DEVELOPMENT AND CONSULTANCY LIMITED R/O A-1, FLAT NO 103, SOAMI NAGAR, MALVIYA NAGAR, DELHI-110017, OCCUPATION-SERVICE	03641879	NEW DELHI	SAHAB NARAIN	12/10/2023
3	ALOK SINGH S/O JAGDHARI SINGH NOMINEE OF REC POWER DEVELOPMENT AND CONSULTANCY LIMITED R/O MF-23, ELDECO MANSIONZ, SECTOR-48, SOHNA ROAD, GURUGRAM - 122018, OCCUPATION-SERVICE	07498786	NEW DELHI	ALOK SINGH	12/10/2023
4	ARVIND KUMAR S/O NAND KISHOR SINGH NOMINEE OF REC POWER DEVELOPMENT AND CONSULTANCY LIMITED R/O T4-8A, SAI VATIKA APARTMENT, SECTOR-63, FARIDABAD - 121004, OCCUPATION-SERVICE	10342637	NEW DELHI	ARVIND KUMAR	12/10/2023
	PUTHIYARKATTU SHIVARAMAN HARIHARAN S/O SHRI PUTHIYARAKAT VELAYUDHAN			P.S HARIHARAN	12/10/2023

57



5	SIVARAMAN NOMINEE OF REC POWER DEVELOPMENT AND CONSULTANCY LIMITED FLAT NO.104, SADAR APARTMENT, MAYUR VIHAR EXTENTION, PHASE-1, PLOT NO.9, NEW DELHI-110091, OCCUPATION-SERVICE	08657652	NEW DELHI		
6	MOHAN LAL KUMAWAT S/O SHRI RAMU RAM KUMAWAT NOMINEE OF REC POWER DEVELOPMENT AND CONSULTANCY LIMITED FLAT NO 142 TOWER -1 GC EMERALD, RAMPRASTHA GREENS VAISHALI SECTOR-7, GHAZIABAD-201010, UTTAR PRADESH, OCCUPATION-SERVICE	07682898	NEW DELHI	Mohan Lal Kumawat	12/10/2023
7	THANGARAJAN BOSH S/O SHRI SITHAN THANGARAJAN NOMINEE OF REC POWER DEVELOPMENT AND CONSULTANCY LIMITE D R/O APARTMENT NO S-2, MIDDLE PORTION 2-B, JANGPURA, MATHURA ROAD, NEW DELHI-110014, OCCUPATION-SERVICE	02772316	NEW DELHI	Subash Chandira Bosh	12/10/2023

Signed before me

Name Prefix (ACA/FCA/ACS/ FCS/ACMA/ FCMA)	*Name of the witness	*Address, Description and Occupation	*DIN / PAN / Passport number / Membership		DSC	Dated
FCA	VINAY KUMAR	1803, TOWER-9, LA RESIDENTIA, TECH ZONE-4, GREATER NOIDA WEST-201306	402996	NEW DELHI	Vinay Digitally signed by Vinay Kumar Date: 2023.10.12 Time: 11:40:29 DIN: 402996	12/10/2023



58



Times of India

Coimbatore

8/11/2023

**REC POWER DEVELOPMENT AND CONSULTANCY LIMITED**  
(A wholly owned subsidiary of REC Ltd.)

**GLOBAL INVITATION (Through e-bidding Only)**  
**FOR SELECTION OF TRANSMISSION SERVICE PROVIDER THROUGH TARIFF BASED**  
**COMPETITIVE BIDDING (TBCB) PROCESS ON BUILD, OWN, OPERATE AND TRANSFER**  
**(BOOT) BASIS FOR ONE (1) INTER - STATE TRANSMISSION PROJECT**

REC Power Development and Consultancy Limited, New Delhi, India (a wholly owned subsidiary of REC Limited, a Maharatna Central Public Sector Undertaking) invites proposal for setting up of the below mentioned transmission project through TBCB process on Build, Own, Operate and Transfer (BOOT) basis following single stage two envelope process of "Request for Proposal (RFP)". Interested bidders may refer to the Request for Proposal (RFP) notifications and RFP documents available on our website [www.recpdcl.in](http://www.recpdcl.in) & [www.recindia.nic.in](http://www.recindia.nic.in) w.e.f. 08.11.2023.

The bidders may obtain the RFP documents on all working days between 1030 hours (IST) to 1600 hours (IST) from 08.11.2023 to one day prior to bid submission date on payment of non-refundable fee of Rs. 5,00,000/- (Rupees Five Lakh Only) or US\$ 7000 (US Dollars Seven Thousand Only) + 18% GST as per details provided in the RFP document available on the website [www.recpdcl.in](http://www.recpdcl.in) & [www.recindia.nic.in](http://www.recindia.nic.in).

The Request for Proposal (RFP) documents can also be downloaded from our website [www.recpdcl.in](http://www.recpdcl.in) & [www.recindia.nic.in](http://www.recindia.nic.in), however in such cases interested parties can submit response to RFP only on submission of non-refundable fee of Rs. 5,00,000/- (Rupees Five Lakh Only) or US\$ 7000 (US Dollars Seven Thousand Only) + 18% GST as per details provided in the RFP document. The survey report & clarifications to RFP documents shall be issued to those bidders, who have obtained/purchased RFP document by paying requisite fee. The important timelines in this regard are as follows:

Sr. No.	Name of Project	Last Date for seeking clarifications	Last Date for submission of Response to RFP	Details of Opening of Response to RFP
1.	Transmission system for evacuation of power from Rajasthan REZ Ph-IV (Part-2: 5.5 GW) (Jaisalmer/Barmer Complex): Part H1	28.11.2023	10.01.2024 up to 1200 Hrs (IST)	10.01.2024 up to 1230 Hrs (IST)

All corrigenda, addenda, amendments, time extensions, etc. to the RFP will be hosted on our websites [www.recpdcl.in](http://www.recpdcl.in) & [www.recindia.nic.in](http://www.recindia.nic.in). Bidders should regularly visit our websites to keep themselves updated.

Note: RECPOCL reserves the right to cancel or modify the process without assigning any reason and without any liability. This is not an offer.

Chief Executive Officer

**REC Power Development and Consultancy Ltd.**

Core-4, SCOPE Complex, 7, Lodhi Road, New Delhi-110003, India

Bid Process Coordinator



An Initiative of



Initiative Partner



Give a missed call on toll free number 18002903011 to get our App



59

**STANDARD SINGLE STAGE REQUEST FOR  
PROPOSAL DOCUMENT**

**FOR**

**SELECTION OF BIDDER AS TRANSMISSION  
SERVICE PROVIDER THROUGH TARIFF BASED  
COMPETITIVE BIDDING PROCESS**

**TO**

**ESTABLISH INTER-STATE TRANSMISSION SYSTEM**

**FOR**

**TRANSMISSION SYSTEM FOR EVACUATION OF  
POWER FROM RAJASTHAN REZ PH-IV (Part-2 :5.5  
GW) (JAISALMER/ BARMER COMPLEX): PART H1**

**ISSUED BY**

**REC Power Development and Consultancy Limited  
(A wholly owned subsidiary of REC Limited)**

**Registered Office:  
Core-4, SCOPE Complex,  
7, Lodhi Road, New Delhi – 110 003  
Email: pshariharan@recpdcl.in & tbc@recpdcl.in**

**08.11.2023**



**RFP for Selection of Bidder as Transmission Service Provider**

8. **Transmission Charges:** The Transmission Charges shall be payable by the Designated ISTS Customers in Indian Rupees through the CTU as per Central Electricity Regulatory Commission (Sharing of Inter-State Transmission Charges and Losses) Regulations as amended from time to time. Bidders shall quote the Transmission Charges as per the pre-specified structure, as mentioned in the RFP.
9. **Issue of RFP document:** The detailed terms and conditions for qualification and selection of the Transmission Service Provider for the Project and for submission of Bid are indicated in the RFP document. All those interested in purchasing the RFP document may respond in writing to Chief Executive Officer, [pshariharan@recpdcl.in](mailto:pshariharan@recpdcl.in) & [tccb@recpdcl.in](mailto:tccb@recpdcl.in) at the address given in para 12 below with a non-refundable fee of Rs. 5,00,000/- (Rupees Five Lakh Only) or US\$ 7,000 (US Dollars Seven Thousand Only) plus GST @18%, to be paid latest by 09.01.2024 via electronic transfer to the following Bank Account:

Bank Name, Address & Branch	IDFC First Bank Limited Wholesale Banking Outlet Express Building, 2nd Floor, 9-10 Bahadur Shah Zafar Marg, New Delhi-110002
Bank Account Name	REC Power Development & Consultancy Limited
Bank Account No	10000697415
Bank IFSC Code No	IDFB0020101

Immediately after issuance of RFP document, the Bidder shall submit the Pre-Award Integrity Pact in the format as prescribed in Annexure B, which shall be applicable for and during the bidding process, duly signed on each page by any whole-time Director / Authorized Signatory, duly witnessed by two persons, and shall be submitted by the Bidder in two (2) originals in a separate envelope, duly superscripted with Pre-Award Integrity Pact. The Bidder shall submit the Pre-Award Integrity Pact on non-judicial stamp paper of Rs. 100/- each duly purchased from the National Capital Territory of Delhi. In case the Bidder is in a consortium, the Pre-Award Integrity Pact shall be signed and submitted by each member of the Consortium separately.

The RFP document shall be issued to the Bidders on any working day from 08.11.2023 to 09.01.2024 between 1030 hours (IST) to 1600 hours (IST). The BPC, on written request and against payment of the above mentioned fee by any Bidder shall promptly dispatch the RFP document to such Bidder by registered mail/ air mail. BPC shall, under no circumstances, be held responsible for late delivery or loss of documents so mailed.

10. **Receipt and opening of Bid:** The Bid must be uploaded online through the electronic bidding platform on or before 1200 hours (IST) on 10.01.2024. Technical Bid will be opened by the Bid Opening Committee on the same day at 1230 hours (IST) in the office of Central Electricity Authority, in the online presence of Bidders' representatives who wish to attend. If the Bid Deadline is a public holiday at the place of submission of Bid, it shall be opened on the next working day at the same time and venue. In addition to the online submission, the Bidder with lowest Final Offer will be required to submit original hard copies of Annexure 3, Annexure 4 (if applicable), Annexure 6 (if applicable) and Annexure 14 before issuance of LoI. Bidders meeting the Qualification Requirements, subject to evaluation as specified in Clause 3.2 to 3.4 shall be declared as "Qualified Bidders" and eligible for opening of Initial Offer.
11. The RFP document is not transferable. BPC reserves the right to reject all Bid and/or annul the process of tariff based competitive bidding for selection of Bidder as TSP to execute the Project without assigning any reason. BPC shall not bear any liability, whatsoever, in this regard.



Date: 12.09.2024

**CERTIFICATE BY BID EVALUATION COMMITTEE**

**Subject: Selection of Successful Bidder as Transmission Service Provider to establish "Transmission System for Evacuation of Power from Rajasthan REZ Ph-IV (Part-2:5.5 GW) (Jaisalmer/ Barmer Complex): Part H1" through tariff based competitive bidding process.**

It is certified that:

- The entire bid process has been carried out in accordance with the "Tariff based Competitive Bidding Guidelines for Transmission Service" and "Guidelines for encouraging competition in development of the Transmission Projects" issued by Ministry of Power, Govt. of India under Section 63 of the Electricity Act, 2003 as amended from time to time.
- M/s Power Grid Corporation of India Limited, with the lowest annual transmission charges of Rs. 2,734.85 Million, emerged as the successful Bidder after the conclusion of electronic reverse auction.
- The transmission charges of Rs. 2,734.85 Million discovered after electronic reverse auction is acceptable.

  
(Rajesh Kumar Singh)  
General Manager,  
CCGRO-II, SBI  
Chairman, BEC

  
(Bhagwan Sahay Bairwa)  
Chief Engineer (I/C)  
PSPA-II, CEA  
Member, BEC

  
(Bhanwar Singh Meena)  
Director (PSETD), CEA  
Member, BEC

  
(D K Meena)  
SE (Operations), NRPC  
Member, BEC

  
(V A Kale)  
SE, RVPN  
Member, BEC

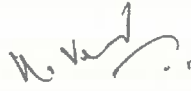
  
(Kuntala Venugopal)  
Chairman - Rajasthan IV H1 Power  
Transmission Limited (SPV)  
Convener - Member, BEC



(62)







Ref No.: RECPDCL/TBCB/Rajasthan Ph-IV Part H1/2024-25/2000

Date: 18.09.2024

To,

**M/s Power Grid Corporation of India Limited**  
'Saudamini', Plot no. 2, Sector – 29,  
Gurugram – 122001 (Haryana)

**Kind Attention: Sh. Pankaj Pandey, ED**

**Subject:** Establishment of "Transmission System for Evacuation of Power from Rajasthan REZ Ph-IV (Part-2: 5.5 GW) (Jaisalmer/Barmer Complex): Part H1" through Tariff Based Competitive Bidding Process (TBCB) – **Letter of Intent.**

Dear Sir,

We refer to:

1. The Request for Proposal (RfP) dated 08.11.2023 comprising RfP, Draft Transmission Service Agreement, Share Purchase Agreement and Survey Report dated 29.11.2023 issued to M/s Power Grid Corporation of India Limited, as regards participation in the Global Invitation for Bids for establishment of "Transmission System for Evacuation of Power from Rajasthan REZ Ph-IV (Part-2: 5.5 GW)(Jaisalmer/Barmer Complex): Part H1" through Tariff Based Competitive Bidding process including all correspondence/clarifications/amendments/errata/corrigendum issued by REC Power Development and Consultancy Limited in regard thereto (hereinafter collectively referred to as the 'Final RFP') till the submission of Bid Deadline and as listed below:
  - (i) Clarifications dated 05.01.2024
  - (ii) Amendment-I dated 09.01.2024,
  - (iii) Amendment-II and Additional Clarifications dated 24.01.2024,
  - (iv) Amendment-III dated 08.02.2024,
  - (v) Amendment-IV dated 20.02.2024,
  - (vi) Amendment-V and Additional Clarifications dated 21.02.2024,
  - (vii) Amendment-VI and Additional Clarifications dated 07.03.2024,
  - (viii) Amendment-VII dated 11.03.2024,
  - (ix) Amendment-VIII dated 19.03.2024,
  - (x) Amendment-IX dated 22.03.2024,
  - (xi) Amendment-X dated 28.03.2024,
  - (xii) Amendment-XI and Additional Clarifications dated 01.04.2024,
  - (xiii) Amendment-XII and Additional Clarifications dated 10.04.2024,
2. The offer of M/s Power Grid Corporation of India Limited by way of a Technical Bid pursuant to (1) above submitted on 19.04.2024 in response to the Final RFP.
3. The Initial Price Offer of M/s Power Grid Corporation of India Limited as submitted on 19.04.2024 in response to the Final RFP.
4. The final offer of M/s Power Grid Corporation of India Limited, discovered during e-Reverse Auction, conducted on 10.09.2024 in response to the Final RFP.
5. The Technical Bid as in (2) above, the Initial Price Offer as in (3) above and the Final Offer as in (4) above hereinafter collectively referred to as the 'Bid'.

63





We are pleased to inform you that your proposal and offer received by way of the 'Bid' has been accepted and M/s Power Grid Corporation of India Limited is here by declared as Successful Bidder as per clause 3.6.1 of the Final RFP for the above project and consequently, this Letter of Intent (hereinafter referred to as the 'LoI') is being issued in 2 copies, One original plus One copy.

This LoI is based on the Final RFP and is further contingent upon you satisfying the following conditions:

- (a) Acknowledging its issuance and unconditionally accepting its contents and recording 'Accepted unconditionally' under the signature and stamp of your authorized signatory on each page of the duplicate copy of this letter attached herewith and returning the same to REC Power Development and Consultancy Limited within 7 (Seven) days from the date of issuance of LoI.
- (b) Completion of various activities as stipulated in the RFP including in particular Clause 2.15.2, Clause 2.15.3 and Clause 2.15.4 of the Final RFP within the timelines as prescribed therein.
- (c) Provide the Contract Performance Guarantee of Rs. 89.00 Crore (Rupees Eighty-Nine Crore Only) within 10 (Ten) days from issue of this LoI, in favour of the Central Transmission Utility of India Limited, as per the provisions of Clause 2.12.

It may be noted that REC Power Development and Consultancy Limited has the rights available to them under the Final RFP, including rights under clause 2.15.5 and 3.6.3 thereof, upon your failure to comply with the aforementioned conditions.

As you are aware, the issuance and contents of this LoI are based on the Bid submitted by you as per the Final RFP including the Transmission Charges and other details regarding the Scheduled COD as contained therein. The Quoted Transmission Charges as submitted by you and the Scheduled COD of transmission elements as agreed by you in your Bid, as per Annexure 21 and Format-1 of Annexure-8 respectively of the Final RFP is enclosed herewith as Schedule-A and incorporated herein by way of reference.

Further, please note that relationship of M/s Power Grid Corporation of India Limited with the REC Power Development and Consultancy Limited & Central Transmission Utility of India Limited will be governed solely on the basis of the Final RFP.

You are requested to unconditionally accept the LoI, and record on one copy of the LoI, 'Accepted unconditionally', under the signature of the authorized signatory of your Company and return such copy to us within 7 (Seven) days of issue of LoI.

Yours faithfully

  
  
Satyaban Sarin  
(Satyaban Sarin)  
General Manager (Tech)

**Enclosures:**

1. Schedule A: Quoted Transmission Charges and the scheduled COD of transmission element submitted in your Bid, as per Annexure 21 and Format-1 of Annexure-8 respectively of the Final RFP.

64

**Copy for kind information to:**

1. **The Secretary,**  
Central Electricity Regulatory Commission,  
6<sup>th</sup> Floor, Tower B, World Trade Centre,  
Nauroji Nagar, New Delhi-110029.
2. **The Chairperson,**  
Central Electricity Authority,  
Sewa Bhawan, R K Puram,  
New Delhi-110086.
3. **The Joint Secretary (Transmission),**  
Ministry of Power,  
Shram Shakti Bhawan,  
Rafi Marg, New Delhi- 110 004.
4. **The Director (Transmission),**  
Ministry of Power, Govt, of India,  
Shram Shakti Bhawan, Raft Marg,  
New Delhi 110001
5. **The Chief Engineer (PSP & PA -I)**  
Central Electricity Authority,  
Sewa Bhawan, R.K. Puram,  
New Delhi – 110066.
6. **The Chief Operating Officer,**  
Central Transmission Utility of India Limited,  
5<sup>th</sup> to 10<sup>th</sup> Floor, Ircn International Tower,  
Tower No.-1, Plot No. 16, Sector 32,  
Gurugram, Haryana - 122003



*[Handwritten signature]*

*[Handwritten number 65]*

**ANNEXURE 21 - FORMAT FOR FINANCIAL BID**

**Quoted Annual Transmission Charges: Rs. 2734.85 Million**

**Notes:**

1. The Bidders are required to ensure compliance with the provisions of Clause 2.5.3 of this RFP.
2. Quotes to be in Rupees Millions and shall be up to two (2) decimal points.
3. The contents of this format shall be clearly typed.
4. The Financial Bid shall be digitally signed by the authorized signatory in whose name power of attorney as per Clause 2.5.2 is issued.
5. Ensure only one value for annual Transmission Charges is quoted. The same charge shall be payable every year to TSP for the term of TSA.



*Satyajit*



*[Handwritten signature]*

66





**UNDERTAKING AND DETAILS OF EQUITY INVESTMENT**

Format 1: Bidders' Undertakings

Date: 10/04/2024

To,  
Chief Executive Officer,  
REC Power Development and Consultancy Limited  
(A wholly owned subsidiary of REC Limited)  
REC Corporate Head Quarter,  
D Block, Plot No. 1-4,  
Sec - 29 Gurugram - 122 001  
Dear Sir,

Sub: Bidders' Undertakings in respect of Bid for selection of Bidder as TSP to establish Inter-State Transmission system for "Transmission system for evacuation of power from Rajasthan REZ Ph-IV (Part-2 :5.5 GW) (Jaisalmer/ Barmer Complex): Part H1".

We hereby undertake on our own behalf and on behalf of the TSP, that if selected as the Successful Bidder for the Project:

1. The Project shall comply with all the relevant electricity laws, codes, regulations, standards and Prudent Utility Practices, environment laws and relevant technical, operational and safety standards, and we shall execute any agreements that may be required to be executed as per law in this regard.
2. We confirm that the Project shall also comply with the standards and codes as per Clause 1.6.1.2 of the RFP and the TSP shall comply with the provisions contained in the Central Electricity Regulatory Commission Grant of Connectivity, Long-term Access and Medium-term Open Access in inter-state Transmission and related matters Open Access) Regulations, 2009.
3. We give our unconditional acceptance to the RFP dated 08.11.2023 issued by the BPC and the RFP Project Documents, as amended, and undertake to ensure that the TSP shall execute all the RFP Project Documents, as per the provisions of this RFP.
4. We have submitted the Bid on the terms and conditions contained in the RFP and the RFP Project Documents. Further, the Financial Bid submitted by us is strictly as per the format provided in Annexure 21 of the RFP, without mentioning any deviations, conditions, assumptions or notes in the said Annexure.
5. Our Bid is valid up to the period required under Clause 2.8 of the RFP.
6. Our Bid has been duly signed by authorized signatory and stamped in the manner specified in the requisite format as per RFP has been enclosed with this undertaking.

*Kaushal*

कौशल किशोर / KAUSHAL KISHUK  
ज्य. महाप्रबंधक (टी.सी.सी.बी.) / DGM (TSCB)  
पावर ग्रिड कॉर्पोरेशन ऑफ इंडिया लिमिटेड  
Power Grid Corporation of India Ltd.  
(भारत सरकार का उद्यम) / (A Govt. of India Enterprise)  
प्लॉट सं-2, सेक्टर-29, गुरुग्राम-122 001 (हरियाणा)  
Plot No. 2, Sector-29, Gurugram-122 001 (Haryana)



7. [NOT APPLICABLE].

8. We confirm that our Bid meets the Scheduled COD of each transmission Element and the Project as specified below:

Sr. No	Name of the Transmission Element	Scheduled COD in months from Effective Date	Percentage of Quoted Transmission Charges recoverable on Scheduled COD of the Element of the Project	Element(s) which are pre-required for declaring the commercial operation (COD) of the respective Element
1.	Establishment of 765/400 kV (2x1500 MVA), 400/220 kV (2x500 MVA) & 220/132 kV (3x200 MVA) Kurawar S/s with 2x330 MVAR 765 kV bus reactor and 1x125 MVAR, 420 kV bus reactor	24 months from SPV transfer	21.25%	All elements of the scheme are required to be commissioned simultaneously as their utilization is dependent on each other.
2.	<ul style="list-style-type: none"> <li>• Mandsaur – Kurawar 765 kV D/c line</li> <li>• 240 MVAR switchable line reactors on each ckt at both ends of Mandsaur – Kurawar 765 kV D/c line</li> <li>• 2 nos. of 765 kV line bays at Mandsaur S/s for termination of Mandsaur – Kurawar 765 kV D/c line</li> </ul>		54.20%	
3.	LILO of Indore – Bhopal 765 kV S/c line at Kurawar		4.88%	
4.	<ul style="list-style-type: none"> <li>• Kurawar – Ashta 400 kV D/c (Quad ACSR/AAAC/AL59 moose equivalent) line</li> <li>• 2 nos. of 400 kV line bays at Ashta (MP) S/s for termination of Kurawar – Ashta 400 kV D/c line</li> </ul>		7.57%	
5.	<ul style="list-style-type: none"> <li>• LILO of one circuit of Indore – Itarsi 400 kV D/c line at Ashta</li> <li>• 2 nos. of 400 kV line bays at Ashta (MP) S/s for LILO of one circuit of Indore – Itarsi 400 kV D/c line at Ashta</li> </ul>		7.74%	
6.	<ul style="list-style-type: none"> <li>• Shujalpur – Kurawar 400 kV D/c (Quad ACSR/AAAC/AL59 moose equivalent) line</li> <li>• 2 nos. of 400 kV line bays at Shujalpur (PG) S/s for termination of Shujalpur – Kurawar 400 kV D/c line</li> </ul>		4.36%	



61

*Kishor*

कौशल किशोर/KAUSHAL KISHOR  
 उप महासंचालक (टी.वी.सी.ई.) / DGM (TVCB)  
 पावर ग्रिड कॉर्पोरेशन ऑफ इंडिया लिमिटेड  
 Power Grid Corporation of India Ltd.  
 (भारत सरकार का उद्यम) / (A Govt. of India Enterprise)  
 प्लॉट सं-2, सेक्टर-29, गुरुगांव-122 001  
 Plot No.-2, Sector-29, Gurgaon-122

*(Signature)*





The TSP shall implement Part H1 in matching timeframe of Parts A, B, C, D, E, F of Rajasthan REZ Ph-IV (Part-2: 5.5 GW) (Jaisalmer/Barmer Complex) on best effort basis.

We agree that the payment of Transmission Charges for any Element irrespective of its successful commissioning on or before its Scheduled COD shall only be considered after the successful commissioning of Element(s) which are pre - required for declaring the commercial operation of such Element as mentioned in the above table.

**Scheduled COD for the Project: 24 months from the date of SPV Transfer.**

9. We confirm that our Financial Bid conforms to all the conditions mentioned in this RFP, and in particular, we confirm that:
- a. Financial Bid in the prescribed format of Annexure 21 has been submitted duly signed by the authorized signatory.
  - b. Financial Bid is unconditional.
  - c. Only one Financial Bid has been submitted.
10. We have neither made any statement nor provided any information in this Bid, which to the best of our knowledge is materially inaccurate or misleading. Further, all the confirmations, declarations and representations made in our Bid are true and accurate. In case this is found to be incorrect after our acquisition of Rajasthan IV H1 Power Transmission Limited, pursuant to our selection as Selected Bidder, we agree that the same would be treated as a TSP's Event of Default under Transmission Service Agreement, and relevant provisions of Transmission Service Agreement shall apply.
11. We confirm that there are no litigations or other disputes against us which materially affect our ability to fulfill our obligations with regard to the Project as per the terms of RFP Project Documents.
12. Power of attorney/ Board resolution as per Clause 2.5.2 is enclosed.

.....  
*Kishor*  
(Signature) कौशल किशोर / KAUSHAL KISHOR  
अससलरंक (वि.वी.सी.वी.) / DGM (TBCB)  
पावर ग्रिड कॉर्पोरेशन ऑफ इंडिया लिमिटेड  
Power Grid Corporation of India Ltd.  
(भारत सरकार का प्रयाग) / (A Govt. of India Enterprise)  
प्लॉट नं०-2, सेक्टर-29, गुरुगाँव-122 001 (हरियाणा)  
Plot No.-2, Sector-29, Gurgaon- 122 001 (Haryana)

Name: Kaushal Kishor  
Designation: Deputy General Manager



*Handwritten signature and initials*

**STANDARD SINGLE STAGE REQUEST FOR  
PROPOSAL DOCUMENT**

**FOR**

**SELECTION OF BIDDER AS TRANSMISSION  
SERVICE PROVIDER THROUGH TARIFF BASED  
COMPETITIVE BIDDING PROCESS**

**TO**

**ESTABLISH INTER-STATE TRANSMISSION SYSTEM**

**FOR**

**TRANSMISSION SYSTEM FOR EVACUATION OF  
POWER FROM RAJASTHAN REZ PH-IV (Part-2 :5.5  
GW) (JAISALMER/ BARMER COMPLEX): PART H1**

**ISSUED BY**

**REC Power Development and Consultancy Limited  
(A wholly owned subsidiary of REC Limited)**

**Registered Office:  
Core-4, SCOPE Complex,  
7, Lodhi Road, New Delhi – 110 003  
Email: pshariharan@recpdcl.in & tbc@recpdcl.in**

**08.11.2023**

**ATTESTED TRUE COPY**

*Attested from Pg 70 - Pg 73*

REC Power Development and Consultancy Limited

1  
Authorized Signatory  
RAJASTHAN IV H1 POWER TRANSMISSION LIMITED



REC Corporate Head Quarter,  
D Block, Plot No. I – 4,  
Sec – 29 Gurugram – 122 001  
Email: pshariharan@recpdcl.in & tcb@recpdcl.in

## 2.15 Other Aspects

2.15.1. The draft of the Transmission Service Agreement has been attached to this RFP. In addition to above, the following documents have also been attached to this RFP:

### a) Share Purchase Agreement

When the drafts of the above RFP Project Documents are provided by the BPC, these RFP Project Documents shall form part of this RFP as per Formats – 1 & 2 of Annexure 20.

Upon finalization of the RFP Project Documents after incorporating the amendments envisaged in Clause 2.4 of this RFP, all the finalized RFP Project Documents shall be provided by BPC to the Bidders at least fifteen (15) days prior to the Bid Deadline.

The Transmission Service Agreement and Share Purchase Agreement shall be signed in required number of originals so as to ensure that one (1) original is retained by each party to the Agreement(s) on the date of transfer of SPV.

2.15.2. Within ten (10) days of the issue of the Letter of Intent, the Selected Bidder shall:

- a) provide the Contract Performance Guarantee in favour of the Nodal Agency as per the provisions of Clause 2.12;
- b) execute the Share Purchase Agreement and the Transmission Service Agreement;
- c) acquire, for the Acquisition Price, one hundred percent (100%) equity shareholding of Rajasthan IV H1 Power Transmission Limited from REC Power Development and Consultancy Limited, who shall sell to the Selected Bidder, the equity shareholding of Rajasthan IV H1 Power Transmission Limited, along with all its related assets and liabilities;

Stamp duties payable on purchase of one hundred percent (100%) of the equity shareholding of Rajasthan IV H1 Power Transmission Limited, along with all its related assets and liabilities, shall also be borne by the Selected Bidder.

Provided further that, if for any reason attributable to the BPC, the above activities are not completed by the Selected Bidder within the above period of ten (10) days as mentioned in this Clause, such period of ten (10) days shall be extended, on a day for day basis till the end of the Bid validity period.

2.15.3. After the date of acquisition of the equity shareholding of Rajasthan IV H1 Power Transmission Limited, along with all its related assets and liabilities, by the Selected Bidder,

- i. the authority of the BPC in respect of this Bid Process shall forthwith cease and any actions to be taken thereafter will be undertaken by the Nodal Agency,



- ii. all rights and obligations of Rajasthan IV H1 Power Transmission Limited, shall be of the TSP,
  - iii. any decisions taken by the BPC prior to the Effective Date shall continue to be binding on the Nodal Agency and
  - iv. contractual obligations undertaken by the BPC shall continue to be fulfilled by the TSP.
  - v. Further, the TSP shall execute the Agreement(s) required, if any, under Central Electricity Regulatory Commission (Sharing of Inter-State Transmission Charges and Losses) Regulations as amended from time to time.
- 2.15.4. Within five (5) working days of the issue of the acquisition of the SPV by the Successful Bidder, the TSP shall apply to the Commission for grant of Transmission License and make an application to the Commission for the adoption of Transmission Charges, as required under Section – 63 of The Electricity Act 2003.
- 2.15.5. If the Selected Bidder / TSP fails or refuses to comply with any of its obligations under Clauses 2.15.2, 2.15.3 and 2.15.4, and provided that the other parties are willing to execute the Share Purchase Agreement and REC Power Development and Consultancy Limited is willing to sell the entire equity shareholding of Rajasthan IV H1 Power Transmission Limited, along with all its related assets and liabilities, to the Selected Bidder, such failure or refusal on the part of the Selected Bidder shall constitute sufficient grounds for cancellation of the Letter of Intent. In such cases, the BPC / its authorized representative(s) shall be entitled to invoke the Bid Bond of the Selected Bidder.
- 2.15.6. If the TSP fails to obtain the Transmission License from the Commission, it will constitute sufficient grounds for annulment of award of the Project.
- 2.15.7. The annulment of award, as provided in Clauses 2.15.5 and 2.15.6 of this RFP, will be done by the Government on the recommendations of National Committee on Transmission. However, before recommending so, National Committee on Transmission will give an opportunity to the Selected Bidder / TSP to present their view point.
- 2.15.8. The annulment of the award, under Clause 2.15.5 or 2.15.6 of this RFP, shall be sufficient grounds for blacklisting the bidder, whose award has been annulled, for a period of five years or more, as decided by the National Committee on Transmission, provided that the blacklisting shall be done only after giving the bidder an opportunity for showing cause.

## 2.16 Confidentiality

- 2.16.1. The parties undertake to hold in confidence this RFP and RFP Project Documents and not to disclose the terms and conditions of the transaction contemplated hereby to third parties, except:
- a) to their professional advisors;
  - b) to their officers, contractors, employees, agents or representatives, financiers, who need to have access to such information for the proper performance of their activities;







Ref No: RECPDCL/TBCB/Raj Ph IV Part H1/2024-25/2370

Date: 15.10.2024

**Sh. Pankaj Pandey, ED,**  
**M/s Power Grid Corporation of India Limited**  
'Saudamini', Plot no. 2, Sector – 29,  
Gurugram – 122001 (Haryana)

**Sub: Establishment of Transmission System for "Transmission System for Evacuation of Power from Rajasthan REZ Ph-IV (Part-2: 5.5 GW)(Jaisalmer/Barmer Complex): Part H1" through tariff based competitive bidding process – Extension of Lol- regarding.**

Ref.: RECPDCL/TBCB/Rajasthan Ph-IV Part H1/2024-25/2000, Dated 18.09.2024

Dear Sir,

This is in reference to above referred Letter of Intent dated 18<sup>th</sup> September, 2024 issued to M/s Power Grid Corporation of India Limited for **Transmission System for Evacuation of Power from Rajasthan REZ Ph-IV (Part-2: 5.5 GW)(Jaisalmer/Barmer Complex): Part H1.**

To complete the activities mentioned under Clause 2.15.2, Clause no. 2.15.3 and Clause no. 2.15.4 of Request for Proposal (RFP) document, the last date for completion of various activities, is extended till 22<sup>nd</sup> October, 2024.

Thanking You,

Yours faithfully,

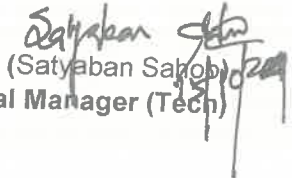
  
(Satyaban Sahob)  
General Manager (Tech)



73



**TRANSMISSION SERVICE AGREEMENT**

**FOR**

**DEVELOPMENT AND OPERATION OF  
INTER-STATE TRANSMISSION SYSTEM**

**FOR TRANSMISSION OF ELECTRICITY  
THROUGH TARIFF BASED COMPETITIVE  
BIDDING FOR**

**TRANSMISSION SYSTEM FOR  
EVACUATION OF POWER FROM  
RAJASTHAN REZ PH-IV (PART-2 :5.5 GW)  
(JAISALMER/ BARMER COMPLEX): PART  
H1**

**BETWEEN THE**

**CENTRAL TRANSMISSION UTILITY OF  
INDIA LIMITED  
(NODAL AGENCY)**

**AND**

**RAJASTHAN IV H1 POWER TRANSMISSION  
LIMITED**



**ATTESTED TRUE COPY**  
Attested from 1874-1929  
Authorized Signatory  
RAJASTHAN IV H1 POWER TRANSMISSION LIMITED



74

**CONTENTS**

1	Definitions and Interpretations.....	6
2	Effectiveness and Term of Agreement .....	17
3	Conditions Subsequent .....	19
4	Development of the Project .....	23
5	Construction of the Project.....	27
6	Connection and commissioning of the Project .....	31
7	Operation and Maintenance of the Project .....	36
8	Availability of the project.....	37
9	Insurances.....	38
10	Billing And Payment of Transmission Charges.....	40
11	Force Majeure .....	41
12	Change in Law.....	45
13	Events of Default and Termination .....	48
14	Liability and Indemnification.....	53
15	Assignments and Charges.....	58
16	Governing Law and Dispute Resolution.....	60
17	Representation and Warranties .....	62
18	Independent Engineer .....	64
19	Miscellaneous Provisions .....	66



Handwritten signature in blue ink.



Handwritten signature in blue ink.

Blank



Indian-Non Judicial Stamp  
Haryana Government



Date: 01/10/2024

Certificate No. G0A2024J306

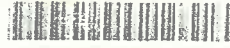

Stamp Duty Paid: ₹ 101

GRN No. 122060477



Penalty: ₹ 0

(Rs. Zero Only)

Deponent

Name: Central Transmission utility of India Ltd

H.No/Floor : 2

Sector/Ward : 29

Landmark : Na.

City/Village : Gurugram

District : Gurugram

State : Haryana

Phone : 98\*\*\*\*\*10



Purpose : ARTICLE 5 GENERAL AGREEMENT to be submitted at Concerned office

**THIS TRANSMISSION SERVICE AGREEMENT** (hereinafter referred to as "TSA" or "Agreement" or "the Agreement" or "this Agreement") is made on the ..... [Insert day] of..... [Insert month] of Two Thousand and Twenty Four.

**BETWEEN:**

The Central Transmission Utility of India Limited, having its registered address at "Saudamini", 1st Floor, Plot No. 2, Sector-29, Gurugram-122001, Haryana and correspondence address 5th to 10th Floor, Icon International Tower, Tower no-1, Plot no -16, Sector-32, Gurugram, Haryana -122003 acting as a Nodal Agency (referred to as the "Nodal Agency"), which expression shall unless repugnant to the context or meaning thereof include its successors, and permitted assigns) as Party of the one part;

**AND**

Rajasthan IV H1 Power Transmission Limited, incorporated under the Companies Act, 2013, having its registered office at Core-4, Scope Complex 7, Lodhi Road Delhi, South Delhi, Delhi 110003 (herein after referred to as "Transmission Service Provider" or "TSP" or "ISTS Licensee", which expression shall unless repugnant to the context or meaning thereof include its successors, and permitted assigns) as Party of the other part;

("Nodal Agency" and "TSP" are individually referred to as "Party" and collectively as the "Parties")



Central Transmission Utility of India Limited 3- Rajasthan IV H1 Power Transmission Limited

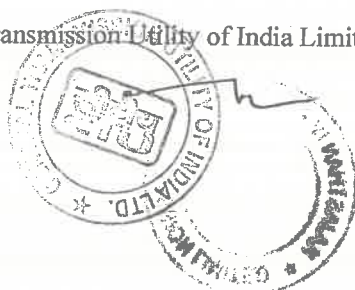

Handwritten signature



**AND WHEREAS:**

- A) In accordance with the Bidding Guidelines, the Bid Process Coordinator (hereinafter referred to as BPC) had initiated a competitive e-reverse bidding process through issue of RFP for selecting a Successful Bidder to build, own, operate and transfer the Project comprising of the Elements mentioned in Schedule 1 (hereinafter referred to as the Project)
- B) Pursuant to the said e-reverse bidding process, the BPC has identified the Successful Bidder, who will be responsible to set up the Project on build, own, operate and transfer basis to provide Transmission Service in accordance with the terms of this Agreement and the Transmission License.
- C) The Selected Bidder have submitted the Contract Performance Guarantee and acquired one hundred percent (100%) of the equity shareholding of Rajasthan IV H1 Power Transmission Limited, along with all its related assets and liabilities in terms of the provisions of the Share Purchase Agreement.
- D) The TSP has agreed to make an application for a Transmission License to the Commission for setting up the Project on build, own, operate and transfer basis.
- E) The TSP has further agreed to make an application to the Commission for the adoption of the Transmission Charges under Section 63 of the Electricity Act, 2003, along with a certification from the Bid Evaluation Committee in accordance with the Bidding Guidelines issued by Ministry of Power, Government of India.
- F) The TSP has agreed to execute the agreement(s) required, if any, under Sharing Regulations within fifteen (15) days from the date of grant of Transmission License from the Commission.
- G) The TSP agrees to the terms and conditions laid down under Sharing Regulations, for making available the ISTS and charge the Transmission Charges in accordance with the terms and conditions of Sharing Regulations.
- H) The billing, collection and disbursement of the Transmission Charges by the CTU to the ISTS Licensee shall be governed as per Sharing Regulations.
- I) The terms and conditions stipulated in the Transmission License issued by the Commission to the TSP shall be applicable to this Agreement and the TSP agrees to comply with these terms and conditions. In case of inconsistency between the Transmission License terms & conditions and the

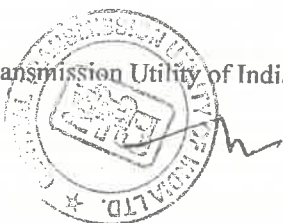

Transmission Service Agreement

conditions of this Agreement, the conditions stipulated in the Transmission License granted by the Commission shall prevail.

**NOW, THEREFORE, IN CONSIDERATION OF THE PREMISES AND MUTUAL AGREEMENTS, COVENANTS AND CONDITIONS SET FORTH HEREIN, IT IS HEREBY AGREED BY AND BETWEEN THE PARTIES HERETO AS FOLLOWS:**



*[Handwritten signature]*



*[Handwritten signature]*



ARTICLE: 1

1 DEFINITIONS AND INTERPRETATIONS

1.1 Definitions:

1.1.1 The words / expressions used in this Agreement, unless as defined below or repugnant to the context, shall have the same meaning as assigned to them by the Electricity Act, 2003 and the rules or regulations framed there under including those issued / framed by the Commission (as defined hereunder), as amended or re-enacted from time to time or the General Clauses Act, failing which it shall bear its ordinary English meaning.

The words/expressions when used in this Agreement shall have the respective meanings as specified below:

**“Acquisition Price”** shall have the same meaning as defined in the Share Purchase Agreement;

**“Act”** or **“Electricity Act”** or **“Electricity Act 2003”** shall mean the Electricity Act, 2003 and any amendments made to the same or any succeeding enactment thereof;

**“Affiliate”** shall mean a company that either directly or indirectly

- i. controls or
- ii. is controlled by or
- iii. is under common control with

a Bidding Company (in the case of a single company) or a Member (in the case of a Consortium) and **“control”** means ownership by one entity of at least twenty-six percent (26%) of the voting rights of the other entity;

**“Availability”** in relation to the Project or in relation to any Element of the Project, for a given period shall mean the time in hours during that period the Project is capable to transmit electricity at its Rated Voltage and shall be expressed in percentage of total hours in the given period and shall be calculated as per the procedure contained in Appendix –IV to Central Electricity Regulatory Commission (Terms and Conditions of Tariff) Regulations, 2024, attached herewith in Schedule 6;

**“Bid”** shall mean technical bid and financial bid submitted by the Bidder in response to the RFP, in accordance with the terms and conditions of the RFP;



“**Bid Deadline**” shall mean the last date and time for submission of the Bid in response to RFP, as specified in the RFP;

“**Bidding Company**” shall refer to such single company that has made a Response to RFP for the Project;

“**Bidding Consortium / Consortium**” shall refer to a group of companies that has collectively made a Response to RFP for the Project;

“**Bid Documents**” or “**Bidding Documents**” shall mean the RFP, along with all attachments thereto or clarifications thereof;

“**Bidding Guidelines**” shall mean the “Tariff Based Competitive Bidding Guidelines for Transmission Service” and “Guidelines for Encouraging Competition in Development of Transmission Projects” issued by Government of India, Ministry of Power under Section – 63 of the Electricity Act as amended from time to time;

“**Bid Process Coordinator**” or “**BPC**” shall mean a person or its authorized representative as notified by the Government of India, responsible for carrying out the process for selection of Bidder who will acquire Transmission Service Provider;

“**Bill**” shall mean any bill raised by the CTU on the DICs to recover the Transmission Charges pursuant to the Sharing Regulations;

“**Business Day**” shall mean a day other than Sunday or a statutory holiday, on which the banks remain open for business in the State in which the Nodal Agency’s registered office is located and the concerned TSP are located;

“**CEA**” shall mean the Central Electricity Authority constituted under Section -70 of the Electricity Act;

“**Change in law**” shall have the meaning ascribed thereto in Article 12;

“**Commercial Operation Date**” or “**COD**” shall mean the date as per Article 6.2;

“**Commission**” or “**CERC**” shall mean the Central Electricity Regulatory Commission referred to in sub-section (1) of Section 76 of the Electricity Act, 2003 or its successors and assigns;

“**Competent Court of Law**” shall mean the Supreme Court or any High Court, or any tribunal or any similar judicial or quasi-judicial body in India that has jurisdiction to adjudicate upon issues relating to the Project;

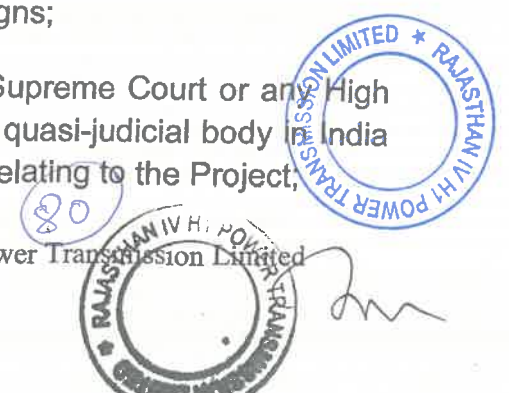

“**Connection Agreement**” shall mean the agreement between the CTU or STU or any other concerned parties and the TSP, setting out the terms relating to the connection of the Project to the Inter-Connection Facilities and use of the Inter State Transmission System as per the provisions of the IEGC, as the case may be;

“**Consultation Period**” shall mean the period of sixty (60) days or such longer period as the Parties may agree, commencing from the date of issue of a TSP’s Preliminary Notice or a Nodal Agency’s Preliminary Termination Notice, as provided in Article 13 of this Agreement, for consultation between the Parties to mitigate the consequence of the relevant event having regard to all the circumstances;

“**Consents, Clearances and Permits**” shall mean all authorizations, licenses, approvals, registrations, permits, waivers, privileges, acknowledgements, agreements, or concessions required to be obtained from or provided by any concerned authority for the development, execution and operation of Project including without any limitation for the construction, ownership, operation and maintenance of the Transmission Lines and/or sub-stations;

“**Construction Period**” shall mean the period from (and including) the Effective Date of the Transmission Service Agreement up to (but not including) the COD of the Element of the Project in relation to an Element and up to (but not including) the COD of the Project in relation to the Project;

“**Contractors**” shall mean the engineering, procurement, construction, operation & maintenance contractors, surveyors, advisors, consultants, designers, suppliers to the TSP and each of their respective sub-contractors (and each of their respective successors and permitted assigns) in their respective capacities as such;

“**Contract Performance Guarantee**” shall mean the irrevocable unconditional bank guarantee, submitted and to be submitted by the TSP or by the Selected Bidder on behalf of the TSP to the Nodal Agency from a bank mentioned in Annexure 17 of the RFP, in the form attached here to as Schedule 8, in accordance with Article 3 of this Agreement and which shall include the additional bank guarantee furnished by the TSP under this Agreement;

“**Contract Year**”, for the purpose of payment of Transmission Charges shall mean the period beginning on the COD, and ending on the immediately succeeding March 31 and thereafter each period of 12 months



beginning on April 1 and ending on March 31 provided that the last Contract Year shall end on the last day of the term of the TSA;

“**CTU**” or “**Central Transmission Utility**” shall have same meaning as defined in the Electricity Act, 2003;

“**Day**” shall mean a day starting at 0000 hours and ending at 2400 hours;

“**D/C**” shall mean Double Circuit;

“**Designated ISTS Customers**” or “**DICs**” shall have the meaning as ascribed in the Sharing Regulations;

“**Dispute**” shall mean any dispute or difference of any kind between the Parties, in connection with or arising out of this Agreement including any issue on the interpretation and scope of the terms of this Agreement as provided in Article 16;

“**Effective Date**” for the purposes of this Agreement, shall have the same meaning as per Article 2.1 of this Agreement;

“**Electrical Inspector**” shall mean a person appointed as such by the Government under sub-section (1) of Section 162 of the Electricity Act 2003 and also includes Chief Electrical Inspector;

“**Electricity Rules 2005**” shall mean the rules framed pursuant to the Electricity Act 2003 and as amended from time to time;

“**Element**” shall mean each Transmission Line or each circuit of the Transmission Lines (where there are more than one circuit) or each bay of Sub-station or switching station or HVDC terminal or inverter station of the Project, including ICTs, Reactors, SVC, FSC, etc. forming part of the ISTS, which will be owned, operated and maintained by the concerned ISTS Licensee, and which has a separate Scheduled COD as per Schedule 2 of this Agreement and has a separate percentage for recovery of Transmission Charges on achieving COD as per Schedule 5 of this Agreement;

“**Event of Default**” shall mean the events as defined in Article 13 of this Agreement;

“**Expiry Date**” shall be the date which is thirty-five (35) years from the COD of the Project;





**“Financial Closure”** shall mean the first Business Day on which funds are made available to the TSP pursuant to the Financing Agreements;

**“Financially Evaluated Entity”** shall mean the company which has been evaluated for the satisfaction of the financial requirement set forth in the RFP;

**“Financing Agreements”** shall mean the agreements pursuant to which the TSP is to finance the Project including the loan agreements, security documents, notes, indentures, security agreements, letters of credit and other documents, as may be amended, modified, or replaced from time to time, but without in anyway increasing the liabilities of the Designated ISTS Customers / Nodal Agency;

**“Financial Year”** shall mean a period of twelve months at midnight Indian Standard Time (IST) between 1st April & 31st March;

**“Force Majeure”** and **“Force Majeure Event”** shall have the meaning assigned thereto in Article 11;

**“GOI”** shall mean Government of India;

**“Grid Code” / “IEGC”** shall mean the Grid Code specified by the Central Commission under Clause (h) of sub-section (1) of Section 79 of the Electricity Act;

**“Independent Engineer”** shall mean an agency/ company, appointed by Nodal Agency in accordance with the Guidelines for Encouraging Competition in Development of Transmission Projects.

**“Indian Governmental Instrumentality”** shall mean Government of India, Government of any State in India or any ministry, department, board, authority, agency, corporation, commission under the direct or indirect control of Government of India or any State Government or both, any political sub-division of any of them including any court or Commission or tribunal or judicial or quasi-judicial body in India but excluding the CTU, TSP and the Designated ISTS Customers;

**“Insurances”** shall mean the insurance cover to be obtained and maintained by the TSP in accordance with Article 9 of this Agreement;

**“Interconnection Facilities”** shall mean the facilities as may be set up for transmission of electricity through the use of the Project, on either one or both side of generating station's / CTU's / STU's / ISTS Licensee's / Designated ISTS Customer's substations (as the case may be) which shall

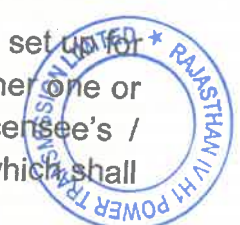



include, without limitation, all other transmission lines, gantries, sub-stations and associated equipment not forming part of the Project;

“**ISTS Licensee**” shall be the TSP under this Agreement, consequent to having been awarded a Transmission License by the CERC and shall be referred to as the TSP or the ISTS Licensee, as the context may require in this Agreement;

“**Law**” or “**Laws**” in relation to this Agreement, shall mean all laws including electricity laws in force in India and any statute, ordinance, rule, regulation, notification, order or code, or any interpretation of any of them by an Indian Governmental Instrumentality having force of law and shall include all rules, regulations, decisions and orders of the Commission;

“**Lead Member of the Bidding Consortium**” or “**Lead Member**” shall mean a company who commits at least 26% equity stake in the Project, meets the technical requirement as specified in the RFP and so designated by other Member(s) in Bidding Consortium;

“**Lenders**” means the banks, financial institutions, multilateral funding agencies, non-banking financial companies registered with the Reserve Bank of India (RBI), insurance companies registered with the Insurance Regulatory & Development Authority (IRDA), pension funds regulated by the Pension Fund Regulatory & Development Authority (PFRDA), mutual funds registered with Securities & Exchange Board of India (SEBI), etc., including their successors and assigns, who have agreed on or before COD of the Project to provide the TSP with the debt financing described in the capital structure schedule, and any successor banks or financial institutions to whom their interests under the Financing Agreements may be transferred or assigned;

Provided that, such assignment or transfer shall not relieve the TSP of its obligations to the Nodal Agency under this Agreement in any manner and shall also does not lead to an increase in the liability of the Nodal Agency;

“**Lenders Representative**” shall mean the person notified by the Lender(s) in writing as being the representative of the Lender(s) or the Security Trustee and such person may from time to time be replaced by the Lender(s) pursuant to the Financing Agreements by written notice to the TSP;

“**Letter of Intent**” or “**LOI**” shall have the same meaning as in the RFP;



84



“**Member in a Bidding Consortium / Member**” shall mean each company in the Bidding Consortium;

“**Month**” shall mean a period of thirty (30) days from (and excluding) the date of the event;

“**Monthly Transmission Charges**” for any Element of the Project, after COD of the Element till COD of the Project, and for the Project after COD of the Project, shall mean the amount of Transmission Charges as specified in Schedule 5 of this Agreement multiplied by no. of days in the relevant month and divided by no. of days in the year;

“**National Load Despatch Centre**” shall mean the centre established as per sub-section (1) of Section 26 of the Electricity Act, 2003;

“**Nodal Agency**” shall mean CTU, which shall execute and implement the Transmission Service Agreement (TSA);

Provided that while taking major decisions, CTU shall consult CEA on technical matters and any other matter it feels necessary.

“**Notification**” shall mean any notification, issued in the Gazette of India;

“**Operating Period**” for any Element of the Project shall mean the period from (and including) the COD of such Element of the Project, up to (and including) the Expiry Date and for the Project, shall mean the period from (and including) the COD of the Project, up to (and including) the Expiry Date;

“**Parent Company**” shall mean an entity that holds at least twenty six percent (26%) of the paid - up equity capital directly or indirectly in the Bidding Company or in the Member in a Bidding Consortium, as the case may be;

“**Preliminary Termination Notice**” shall mean a Nodal Agency's Preliminary Termination Notice as defined in Article 13 of this Agreement;

“**Project**” shall mean Transmission system for evacuation of power from Rajasthan REZ Ph-IV (Part-2 :5.5 GW) (Jaisalmer/Barmer Complex): Part H1, as detailed in Schedule 1 of this Agreement;

“**Project Assets**” shall mean all physical and other assets relating to and forming part of the Project including:

(a) rights over the Site for substations, ROW for transmission lines

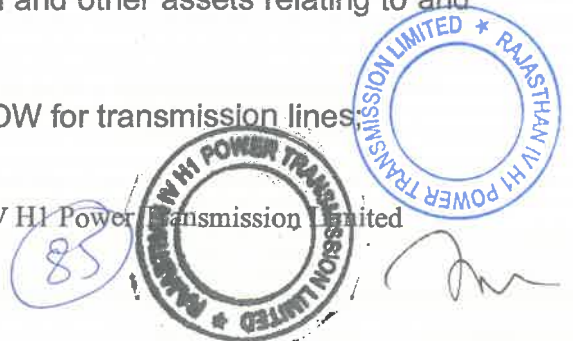

(b) tangible & intangible assets such as civil works and equipment including foundations, embankments, pavements, electrical systems, communication systems, relief centres, administrative offices, Sub-stations, software, tower and sub-stations designs etc;

(c) project facilities situated on the Site;

(d) all rights of the TSP under the project agreements;

(e) financial assets, such as receivables, security deposits etc;

(f) insurance proceeds; and

(g) Applicable Permits and authorisations relating to or in respect of the Transmission System;”

“**Project Execution Plan**” shall mean the plan referred to in Article 3.1.3(c) hereof;

“**Prudent Utility Practices**” shall mean the practices, methods and standards that are generally accepted internationally from time to time by electric transmission utilities for the purpose of ensuring the safe, efficient and economic design, construction, commissioning, operation, repair and maintenance of the Project and which practices, methods and standards shall be adjusted as necessary, to take account of:

- (i) operation, repair and maintenance guidelines given by the manufacturers to be incorporated in the Project,
- (ii) the requirements of Law, and
- (iii) the physical conditions at the Site;
- (iv) the safety of operating personnel and human beings;

“**Rated Voltage**” shall mean voltage at which the Transmission System is designed to operate or such lower voltage at which the line is charged, for the time being, in consultation with the Central Transmission Utility;

“**Rebate**” shall have the meaning as ascribed to in Article 10.3 of this Agreement;

“**RFP**” shall mean Request for Proposal dated 08.11.2023 along with all schedules, annexures and RFP Project Documents attached thereto, issued by the BPC for tariff based competitive bidding process for selection

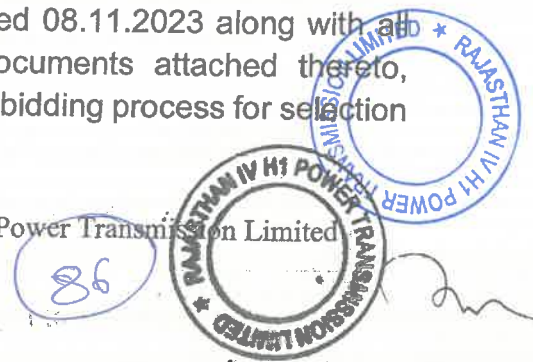

of Bidder as TSP to execute the Project, including any modifications, amendments or alterations thereto;

**“RFP Project Documents”** shall mean the following documents to be entered into in respect of the Project, by the Parties to the respective agreements:

- a. Transmission Service Agreement,
- b. Share Purchase Agreement,
- c. Agreement(s) required under Sharing Regulations and
- d. Any other agreement as may be required;

**“RLDC”** shall mean the relevant Regional Load Dispatch Centre as defined in the Electricity Act, 2003, in the region(s) in which the Project is located;

**“RPC”** shall mean the relevant Regional Power Committee established by the Government of India for the specific Region(s) in accordance with the Electricity Act, 2003 for facilitating integrated operation of the Power System in that Region;

**“Scheduled COD”** in relation to an Element(s) shall mean the date(s) as mentioned in Schedule 2 as against such Element(s) and in relation to the Project, shall mean the date as mentioned in Schedule 2 as against such Project, subject to the provisions of Article 4.4 of this Agreement, or such date as may be mutually agreed among the Parties;

**“Scheduled Outage”** shall mean the final outage plan as approved by the RPC as per the provisions of the Grid Code;

**“Selected Bid”** shall mean the technical Bid and the Final Offer of the Selected Bidder submitted during e-reverse bidding, which shall be downloaded and attached in Schedule 7 on or prior to the Effective Date;

**“Share Purchase Agreement”** shall mean the agreement amongst REC Power Development and Consultancy Limited, Rajasthan IV H1 Power Transmission Limited and the Successful Bidder for the purchase of one hundred (100%) per cent of the shareholding of the Rajasthan IV H1 Power Transmission Limited for the Acquisition Price, by the Successful Bidder on the terms and conditions as contained therein;

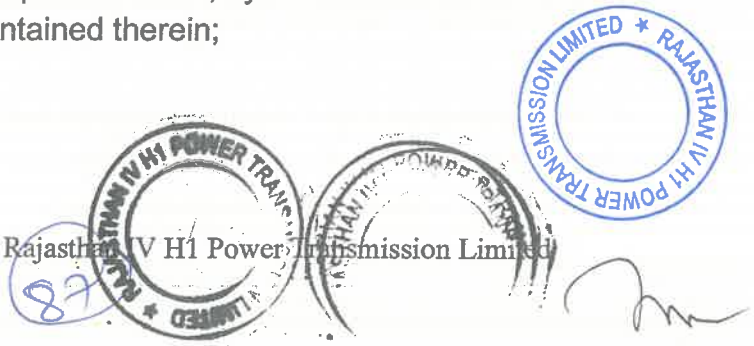
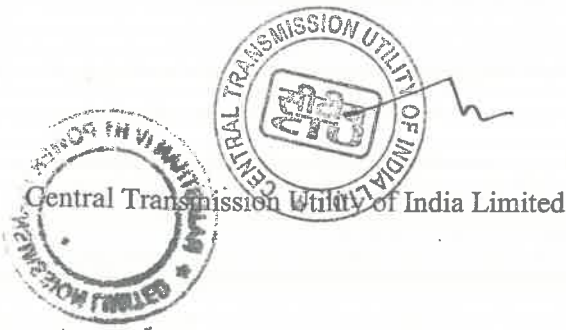



**“Sharing Regulations”** shall mean the Central Electricity Regulatory Commission (Sharing of Inter-State Transmission Charges and Losses) Regulations, 2020 and as amended from time to time;

**“Site”** in relation to a substation, switching station or HVDC terminal or inverter station, shall mean the land and other places upon which such station / terminal is to be established;

**“SLDC”** shall mean the State Load Despatch Centre established as per sub-section (1) of Section 31 of the Electricity Act 2003;

**“STU”** or **“State Transmission Utility”** shall be the Board or the Government company, specified as such by the State Government under sub-section (1) of Section 39 of the Electricity Act 2003;

**“Successful Bidder”** or **“Selected Bidder”** shall mean the Bidder selected pursuant to the RFP and who has to acquire one hundred percent (100%) equity shares of Rajasthan IV H1 Power Transmission Limited, along with all its related assets and liabilities, which will be responsible as the TSP to establish the Project on build, own, operate and transfer basis as per the terms of the TSA and other RFP Project Documents;

**“TSP’s Preliminary Notice”** shall mean a notice issued by the TSP in pursuant to the provisions of Article 13.3 of this Agreement;

**“Target Availability”** shall have the meaning as ascribed hereto in Article 8.2 of this Agreement;

**“Technically Evaluated Entity”** shall mean the company which has been evaluated for the satisfaction of the technical requirement set forth in RFP;

**“Termination Notice”** shall mean a Nodal Agency’s Termination Notice given by the Nodal Agency to the TSP pursuant to the provisions of Articles 3.3.2, 3.3.4, 4.4.2, 5.8, 13.2 and 13.3 of this Agreement for the termination of this Agreement;

**“Term of Agreement”** for the purposes of this Agreement shall have the meaning ascribed thereto in Article 2.2 of this Agreement;

**“Transmission Charges”** shall mean the Final Offer of the Selected Bidder during the e-reverse bidding and adopted by the Commission payable to the TSP as per Sharing Regulations;



88





“**Transmission License**” shall mean the license granted by the Commission in terms of the relevant regulations for grant of such license issued under the Electricity Act;

“**Transmission Service**” shall mean making the Project available as per the terms and conditions of this Agreement and Sharing Regulations;

“**Unscheduled Outage**” shall mean an interruption resulting in reduction of the Availability of the Element(s) / Project (as the case may be) that is not a result of a Scheduled Outage or a Force Majeure Event.

“**Ultimate Parent Company**” shall mean an entity which owns at least twenty six percent (26%) equity in the Bidding Company or Member of a Consortium, (as the case may be) and in the Technically Evaluated Entity and / or Financially Evaluated Entity (as the case may be) and such Bidding Company or Member of a Consortium, (as the case may be) and the Technically Evaluated Entity and / or Financially Evaluated Entity (as the case may be) shall be under the direct control or indirectly under the common control of such entity;

## 1.2 Interpretation:

*Save where the contrary is indicated, any reference in this Agreement to:*

“**Agreement**” shall be construed as including a reference to its Schedules, Appendices and Annexures;

“**Rupee**”, “**Rupees**” and “**Rs.**” shall denote lawful currency of India;

“**crore**” shall mean a reference to ten million (10,000,000) and a “**lakh**” shall mean a reference to one tenth of a million (1,00,000);

“**encumbrance**” shall be construed as a reference to a mortgage, charge, pledge, lien or other encumbrance securing any obligation of any person or any other type of preferential arrangement (including, without limitation, title transfer and retention arrangements) having a similar effect;

“**holding company**” of a company or corporation shall be construed as a reference to any company or corporation of which the other company or corporation is a subsidiary;

“**indebtedness**” shall be construed so as to include any obligation (whether incurred as principal or surety) for the payment or repayment of money, whether present or future, actual or contingent;

“**person**” shall have the meaning as defined in Section 2 (49) of the Act;

“**subsidiary**” of a company or corporation (the holding company) shall be construed as a reference to any company or corporation;

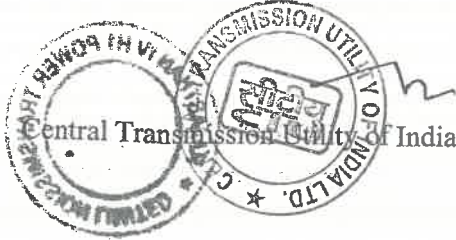

- (i) which is controlled, directly or indirectly, by the holding company, or
- (ii) more than half of the issued share capital of which is beneficially owned, directly or indirectly, by the holding company, or
- (iii) which is a subsidiary of another subsidiary of the holding company,

for these purposes, a company or corporation shall be treated as being controlled by another if that other company or corporation is able to direct its affairs and/or to control the composition of its board of directors or equivalent body;

"winding-up", "dissolution", "insolvency", or "reorganization" in the context of a company or corporation shall have the same meaning as defined in the Companies Act, 1956/ Companies Act, 2013 (as the case may be).

- 1.2.1 Words importing the singular shall include the plural and vice versa.
- 1.2.2 This Agreement itself or any other agreement or document shall be construed as a reference to this or to such other agreement or document as it may have been, or may from time to time be, amended, varied, novated, replaced or supplemented.
- 1.2.3 A Law shall be construed as a reference to such Law including its amendments or re-enactments from time to time.
- 1.2.4 A time of day shall, save as otherwise provided in any agreement or document be construed as a reference to Indian Standard Time.
- 1.2.5 Different parts of this Agreement are to be taken as mutually explanatory and supplementary to each other and if there is any inconsistency between or among the parts of this Agreement, they shall be interpreted in a harmonious manner so as to give effect to each part.
- 1.2.6 The tables of contents and any headings or sub-headings in this Agreement have been inserted for ease of reference only and shall not affect the interpretation of this Agreement.
- 1.2.7 All interest payable under this Agreement shall accrue from day to day and be calculated on the basis of a year of three hundred and sixty-five (365) days.



- 1.2.8 The words "hereof" or "herein", if and when used in this Agreement shall mean a reference to this Agreement.
- 1.2.9 The contents of Schedule 7 shall be referred to for ascertaining accuracy and correctness of the representations made by the Selected Bidder in Article 17.2.1 hereof.

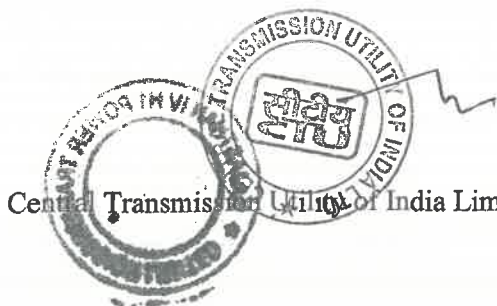

## ARTICLE: 2

### 2 EFFECTIVENESS AND TERM OF AGREEMENT

#### 2.1 Effective Date:

This Agreement shall be effective from later of the dates of the following events:

- a. The Selected Bidder, on behalf of the TSP, has provided the Contract Performance Guarantee, as per terms of Article 3.1 of this Agreement; and
- b. The Selected Bidder has acquired for the Acquisition Price, one hundred percent (100%) of the equity shareholding of REC Power Development and Consultancy Limited in Rajasthan IV H1 Power Transmission Limited along with all its related assets and liabilities as per the provisions of the Share Purchase Agreement. and
- c. The Agreement is executed and delivered by the Parties;

#### 2.2 Term and Termination:

2.2.1 Subject to Article 2.2.3 and Article 2.4, this Agreement shall continue to be effective in relation to the Project until the Expiry Date, when it shall automatically terminate.

2.2.2 Post the Expiry Date of this Agreement, the TSP shall ensure transfer of Project Assets to CTU or its successors or an agency as decided by the Central Government at zero cost and free from any encumbrance and liability. The transfer shall be completed within 90 days of expiry of this Agreement failing which CTU shall be entitled to take over the Project Assets Suo moto.

2.2.3 This Agreement shall terminate before the Expiry Date in accordance with Article 13 or Article 3.3.2 or Article 3.3.4.

#### 2.3 Conditions prior to the expiry of the Transmission License

2.3.1 In order to continue the Project beyond the expiry of the Transmission License, the TSP shall be obligated to make an application to the Commission at least two (2) years before the date of expiry of the Transmission License, seeking the Commission's approval for the extension of the term of the Transmission License up to the Expiry Date.

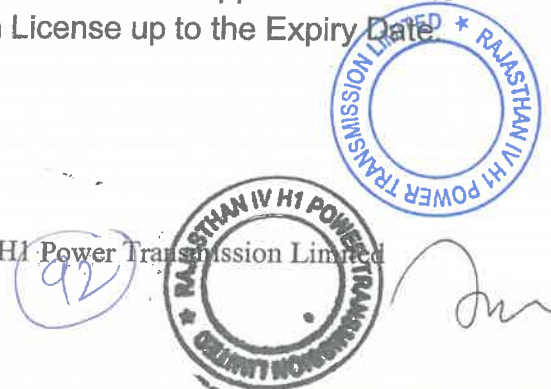



2.3.2 The TSP shall timely comply with all the requirements that may be laid down by the Commission for extension of the term of the Transmission License beyond the initial term of twenty-five (25) years & up to the Expiry Date and the TSP shall keep the Nodal Agency fully informed about the progress on its application for extension of the term of the Transmission License.

**2.4 Survival:**

The expiry or termination of this Agreement shall not affect any accrued rights, obligations/ roles and liabilities of the Parties under this Agreement, including the right to receive liquidated damages as per the terms of this Agreement, nor shall it effect the survival of any continuing obligations/ roles for which this Agreement provides, either expressly or by necessary implication, which are to survive after the Expiry Date or termination including those under Articles 3.3.3, 3.3.5, Article 9.3 (Application of Insurance Proceeds), Article 11 (Force Majeure), Article 13 (Events of Default and Termination), Article 14 (Liability & Indemnification), Article 16 (Governing Law & Dispute Resolution), Article 19 (Miscellaneous).

**2.5 Applicability of the provisions of this Agreement**

2.5.1 For the purpose of Availability, Target Availability and the computation of Availability, Incentive, Penalty, the provisions provided in this Agreement shall apply and any future modifications in the relevant Rules and Regulations shall not be applicable for this Project.

2.5.2 For the purposes of this Agreement for ISTS systems developed under the tariff based competitive bidding framework, the provisions relating to the definitions (Availability and COD), Article 3 (Contract Performance Guarantee and Conditions Subsequent), Article 5 (Construction of the Project), Article 6 (Connection and Commissioning of the Project), Article 8 (Target Availability and calculation of Availability), Article 11 (Force Majeure), Article 12 (Change in Law), Article 13 (Event of Default), Article 14 (Indemnification), Article 15 (Assignment and Charges), Articles 16.1, 16.2 and 16.4 (Governing Laws and Dispute Resolution) and Article 17 (representation and warranties of the ISTS Licensee) of this agreement shall supersede the corresponding provisions under Sharing Regulations.



93



## ARTICLE: 3

### 3 CONDITIONS SUBSEQUENT

#### 3.1 Satisfaction of conditions subsequent by the TSP

3.1.1 Within ten (10) days from the date of issue of Letter of Intent, the Selected Bidder, shall:

- a. Provide the Contract Performance Guarantee, and
- b. Acquire, for the Acquisition Price, one hundred percent (100%) equity shareholding of Rajasthan IV H1 Power Transmission Limited from REC Power Development and Consultancy Limited, who shall sell to the Selected Bidder, the equity shareholding of Rajasthan IV H1 Power Transmission Limited, along with all its related assets and liabilities.
- c. Execute this Agreement;

The TSP shall, within five (5) working days from the date of acquisition of SPV by the Selected Bidder, undertake to apply to the Commission for the grant of Transmission License and for the adoption of tariff as required under section-63 of the Electricity Act.

The Selected Bidder, on behalf of the TSP, will provide to the Central Transmission Utility of India Limited (being the Nodal Agency) the Contract Performance Guarantee for an amount of Rs. 89.00 Crore (Rupees Eighty-Nine Crore only).

3.1.2 The Contract Performance Guarantee shall be initially valid for a period up to three (3) months after the Scheduled COD of the Project and shall be extended from time to time to be valid for a period up to three (3) months after the COD of the Project. In case the validity of the Contract Performance Guarantee is expiring before the validity specified in this Article, the TSP shall, at least thirty (30) days before the expiry of the Contract Performance Guarantee, replace the Contract Performance Guarantee with another Contract Performance Guarantee or extend the validity of the existing Contract Performance Guarantee until the validity period specified in this Article.

3.1.3 The TSP agrees and undertakes to duly perform and complete the following activities within six (6) months from the Effective Date (except for c) below), unless such completion is affected due to any Force Majeure Event, or if any of the activities is specifically waived in writing by the Nodal Agency:

To obtain the Transmission License for the Project from the

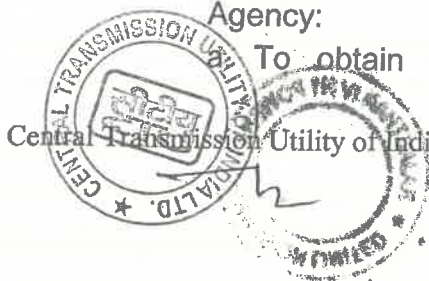

Central Transmission Utility of India Limited

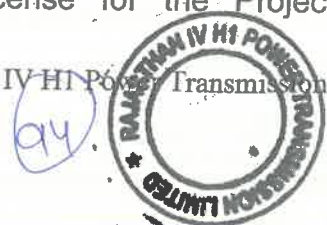

Commission;

- b. To obtain the order for adoption of Transmission Charges by the Commission, as required under Section 63 of the Electricity Act 2003;
- c. To submit to the Nodal Agency, CEA & Independent Engineer, the Project Execution Plan, immediately after award of contract(s) and maximum within one hundred and twenty (120) days from the Effective Date. Also, an approved copy each of Manufacturing Quality Plan (MQP) and Field Quality Plan (FQP) would be submitted to Independent Engineer & Nodal Agency in the same time period. The TSP's Project Execution Plan should be in conformity with the Scheduled COD as specified in Schedule 2 of this Agreement, and shall bring out clearly the organization structure, time plan and methodology for executing the Project, award of major contracts, designing, engineering, procurement, shipping, construction, testing and commissioning to commercial operation;
- d. To submit to the Nodal Agency, CEA & Independent Engineer a detailed bar (GANTT) chart of the Project outlining each activity (taking longer than one Month), linkages as well as durations;
- e. To submit to the Nodal Agency, CEA & Independent Engineer detailed specifications of conductor meeting the functional specifications specified in RFP;
- f. To achieve Financial Closure;
- g. To provide an irrevocable letter to the Lenders duly accepting and acknowledging the rights provided to the Lenders under the provisions of Article 15.3 of this Agreement and all other RFP Project Documents;
- h. To award the Engineering, Procurement and Construction contract ("EPC contract") for the design and construction of the Project and shall have given to such Contractor an irrevocable notice to proceed; and
- i. To sign the Agreement(s) required, if any, under Sharing Regulations.

### **3.2 Recognition of Lenders' Rights by the Nodal Agency**

3.2.1 The Nodal Agency hereby accepts and acknowledges the rights provided to the Lenders as per Article 15.3 of this Agreement and all other RFP Project Documents.

### **3.3 Consequences of non-fulfilment of conditions subsequent**

3.3.1 If any of the conditions specified in Article 3.1.3 is not duly fulfilled by the TSP even within three (3) Months after the time specified therein, then on and from the expiry of such period and until the TSP has satisfied all the conditions specified in Article 3.1.3, the TSP shall, on a monthly basis, be

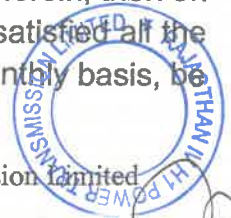
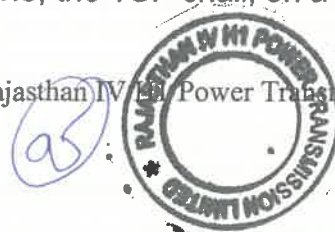

liable to furnish to Central Transmission Utility of India Limited (being the Nodal Agency) additional Contract Performance Guarantee of Rupees Eight Crore Ninety Lakh Only (Rs. 8.90 Crore) within two (2) Business Days of expiry of every such Month. Such additional Contract Performance Guarantee shall be provided to Central Transmission Utility of India Limited (being the Nodal Agency) in the manner provided in Article 3.1.1 and shall become part of the Contract Performance Guarantee and all the provisions of this Agreement shall be construed accordingly. Central Transmission Utility of India Limited (being the Nodal Agency) shall be entitled to hold and / or invoke the Contract Performance Guarantee, including such additional Contract Performance Guarantee, in accordance with the provisions of this Agreement.

3.3.2 Subject to Article 3.3.4, if:

- (i) the fulfilment of any of the conditions specified in Article 3.1.3 is delayed beyond nine (9) Months from the Effective Date and the TSP fails to furnish additional Contract Performance Guarantee to the Nodal Agency in accordance with Article 3.3.1 hereof; or
- (ii) the TSP furnishes additional Performance Guarantee to the Nodal Agency in accordance with Article 3.3.1 hereof but fails to fulfil the conditions specified in Article 3.1.3 within a period of twelve (12) months from the Effective Date,

the Nodal Agency shall have the right to terminate this Agreement, by giving a Termination Notice to the TSP, in writing, of at least seven (7) days, with a copy to CEA and the Lenders' Representative in order to enable the Lenders to exercise right of substitution in accordance with Article 15.3 of this Agreement.

3.3.3 If the Nodal Agency elects to terminate this Agreement as per the provisions of Article 3.3.2, the TSP shall be liable to pay to the Nodal Agency an amount of Rs. 89.00 Crore (Rupees Eighty-Nine Crore Only) as liquidated damages. The Nodal Agency shall be entitled to recover this amount of damages by invoking the Contract Performance Guarantee to the extent of liquidated damages, which shall be required by the Nodal Agency, and the balance shall be returned to TSP, if any. It is clarified for removal of doubt that this Article shall survive the termination of this Agreement.

3.3.4 In case of inability of the TSP to fulfil the conditions specified in Article 3.1.3 due to any Force Majeure Event, the time period for fulfilment of the condition subsequent as mentioned in Article 3.1.3, may be extended for

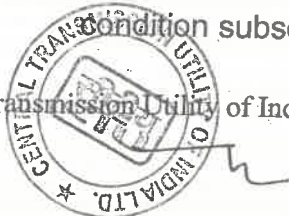



a period of such Force Majeure Event. Alternatively, if deemed necessary, this Agreement may be terminated by the Nodal Agency by giving a Termination Notice to the TSP, in writing, of at least seven (7) days, with a copy to CEA and the Lenders' Representative in order to enable the Lenders to exercise right of substitution in accordance with Article 15.3 of this Agreement and the Contract Performance Guarantee shall be returned as per the provisions of Article 6.5.1.

Provided, that due to the provisions of this Article 3.3.4, any increase in the time period for completion of conditions subsequent mentioned under Article 3.1.3, shall lead to an equal increase in the time period for the Scheduled COD. If the Scheduled COD is extended beyond a period of one hundred eighty (180) days due to the provisions of this Article 3.3.4, the TSP will be allowed to recover the interest cost during construction corresponding to the period exceeding one hundred eighty (180) days by adjustment in the Transmission Charges in accordance with Schedule 9.

3.3.5 Upon termination of this Agreement as per Articles 3.3.2 and 3.3.4, the Nodal Agency may take steps to bid out the Project again.

3.3.6 The Nodal agency, on the failure of the TSP to fulfil its obligations, if it considers that there are sufficient grounds for so doing, apart from invoking the Contract Performance Guarantee under para 3.3.3 may also initiate proceedings for blacklisting the TSP as per provisions of Article 13.2 of TSA.

### 3.4 Progress Reports

The TSP shall notify the Nodal Agency and CEA in writing at least once a Month on the progress made in satisfying the conditions subsequent in Articles 3.1.3.



92

**ARTICLE: 4**

**4 DEVELOPMENT OF THE PROJECT**

**4.1 TSP's obligations in development of the Project:**

Subject to the terms and conditions of this Agreement, the TSP at its own cost and expense shall observe, comply with, perform, undertake and be responsible:

- a. for procuring and maintaining in full force and effect all Consents, Clearances and Permits, required in accordance with Law for development of the Project;
- b. for financing, constructing, owning and commissioning each of the Element of the Project for the scope of work set out in Schedule 1 of this Agreement in accordance with:
  - i. the Electricity Act and the Rules made thereof;
  - ii. the Grid Code;
  - iii. the CEA Regulations applicable, and as amended from time to time, for Transmission Lines and sub-stations:
    - the Central Electricity Authority (Technical Standards for Connectivity to the Grid) Regulations, 2007;
    - Central Electricity Authority (Technical Standards for construction of Electrical Plants and Electric Lines) Regulation, 2010;
    - Central Electricity Authority (Grid Standard) Regulations, 2010;
    - Central Electricity Authority (Safety requirements for construction, operation and maintenance of Electrical Plants and Electrical Lines) Regulation, 2011;
    - Central Electricity Authority (Measures relating to Safety and Electricity Supply) Regulation, 2010;
    - Central Electricity Authority (Technical Standards for Communication System in Power System Operation) Regulations, 2020.
  - iv. Safety/ security Guidelines laid down by the Government;
  - v. Prudent Utility Practices, relevant Indian Standards and the Law;

not later than the Scheduled COD as per Schedule 2 of this Agreement;

for entering into a Connection Agreement with the concerned parties in accordance with the Grid Code.

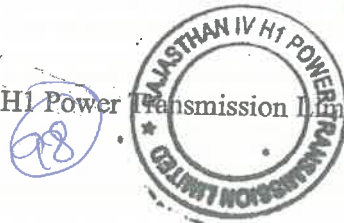



- d. for owning the Project throughout the term of this Agreement free and clear of any encumbrances except those expressly permitted under Article 15 of this Agreement;
- e. to co-ordinate and liaise with concerned agencies and provide on a timely basis relevant information with regard to the specifications of the Project that may be required for interconnecting the Project with the Interconnection Facilities;
- f. for providing all assistance to the Arbitrators as they may require for the performance of their duties and responsibilities;
- g. to provide to the Nodal Agency and CEA, on a monthly basis, progress reports with regard to the Project and its execution (in accordance with prescribed form) to enable the CEA to monitor and co-ordinate the development of the Project matching with the Interconnection Facilities;
- h. to comply with Ministry of Power order no. 25-11/6/2018 – PG dated 02.07.2020 as well as other Guidelines issued by Govt. of India pertaining to this;
- i. to procure the products associated with the Transmission System as per provisions of Public Procurement (Preference to Make in India) orders issued by Ministry of Power vide orders No. 11/5/2018 - Coord. dated 28.07.2020 for transmission sector, as amended from time to time read with Department for Promotion of Industry and Internal Trade (DPIIT) orders in this regard (Procuring Entity as defined in above orders shall deemed to have included Selected Bidder and/ or TSP).

Also, to comply with Department of Expenditure, Ministry of Finance vide Order (Public Procurement No 1) bearing File No. 6/18/2019-PPD dated 23.07.2020, Order (Public Procurement No 2) bearing File No. 6/18/2019-PPD dated 23.07.2020 and Order (Public Procurement No. 3) bearing File No. 6/18/2019-PPD, dated 24.07.2020, as amended from time to time, regarding public procurement from a bidder of a country, which shares land border with India;

- j. to submit to Nodal Agency information in the prescribed format [To be devised by Nodal Agency] for ensuring compliance to Article 4.1 i) above.
- k. to comply with all its obligations undertaken in this Agreement.

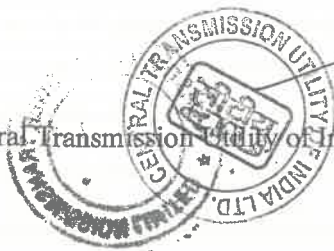

**4.2 Roles of the Nodal Agency in implementation of the Project:**

- 4.2.1 Subject to the terms and conditions of this Agreement, the Nodal Agency shall be the holder and administrator of this Agreement and shall inter alia:
- a. appoint an Independent Engineer within 90 days of the Effective Date
  - b. provide letters of recommendation to the concerned Indian Governmental Instrumentality, as may be requested by the TSP from time to time, for obtaining the Consents, Clearances and Permits required for the Project;
  - c. coordinate among TSP and upstream/downstream entities in respect of Interconnection Facilities; and
  - d. monitor the implementation of the Agreement and take appropriate action for breach thereof including revocation of guarantees, cancellation of Agreement, blacklisting etc
  - e. provide all assistance to the Arbitrators as required for the performance of their duties and responsibilities; and
  - f. perform any other responsibility (ies) as specified in this Agreement.

**4.3 Time for Commencement and Completion:**

- a. The TSP shall take all necessary steps to commence work on the Project from the Effective Date of the Agreement and shall achieve Scheduled COD of the Project in accordance with the time schedule specified in Schedule 2 of this Agreement;
- b. The COD of each Element of the Project shall occur no later than the Scheduled COD or within such extended time to which the TSP shall be entitled under Article 4.4 hereto.

**4.4 Extension of time:**

4.4.1 In the event that the TSP is unable to perform its obligations for the reasons solely attributable to the Nodal Agency, the Scheduled COD shall be extended, by a 'day to day' basis, subject to the provisions of Article 13.

4.4.2 In the event that an Element or the Project cannot be commissioned by its Scheduled COD on account of any Force Majeure Event as per Article 11, the Scheduled COD shall be extended, by a 'day to day' basis for a period of such Force Majeure Event. Alternatively, if deemed necessary, the Nodal Agency may terminate the Agreement as per the provisions of Article 13.4 by giving a Termination Notice to the TSP, in writing, of at least seven (7) days, with a copy to CEA and the Lenders' Representative in order to enable the Lenders to exercise right of substitution in accordance with Article 15.3 of this Agreement.

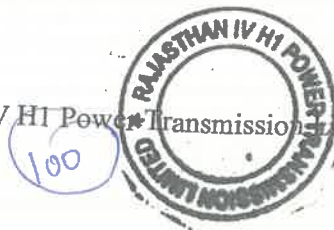

4.4.3 If the Parties have not agreed, within thirty (30) days after the affected Party's performance has ceased to be affected by the relevant circumstance, on how long the Scheduled COD should be deferred by, any Party may raise the Dispute to be resolved in accordance with Article 16.

**4.5 Metering Arrangements:**

4.5.1 The TSP shall comply with all the provisions of the IEGC and the Central Electricity Authority (Installation and Operation of Meters) Regulations, 2006 as amended from time to time, with regard to the metering arrangements for the Project. The TSP shall fully cooperate with the CTU / STU / RLDC and extend all necessary assistance in taking meter readings.

**4.6 Interconnection Facilities:**

4.6.1 Subject to the terms and conditions of this Agreement, the TSP shall be responsible for connecting the Project with the interconnection point(s) specified in Schedule 1 of this Agreement. The Interconnection Facilities shall be developed as per the scope of work and responsibilities assigned in Schedule 1 of this Agreement. The Nodal Agency shall be responsible for coordinating to make available the Interconnection Facilities.

4.6.2 In order to remove any doubts, it is made clear that the obligation of the TSP within the scope of the project is to construct the Project as per Schedule-1 of this Agreement and in particular to connect it to the Interconnection Facilities as specified in this Agreement.

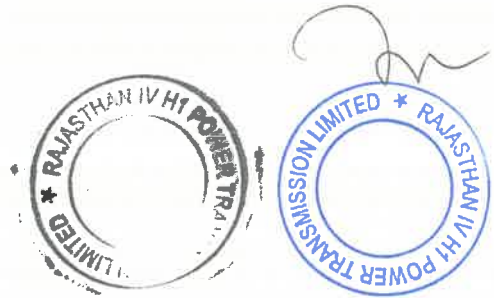

**ARTICLE: 5**

**5 CONSTRUCTION OF THE PROJECT**

**5.1 TSP's Construction Responsibilities:**

5.1.1 The TSP, at its own cost and expense, shall be responsible for designing, constructing, erecting, testing and commissioning each Element of the Project by the Scheduled COD in accordance with the Regulations and other applicable Laws specified in Article 4.1 of this Agreement.

5.1.2 The TSP acknowledges and agrees that it shall not be relieved from any of its obligations under this Agreement or be entitled to any extension of time or any compensation whatsoever by reason of the unsuitability of the Site or Transmission Line route(s).

5.1.3 The TSP shall be responsible for obtaining all Consents, Clearances and Permits related but not limited to road / rail / river / canal / power line / crossings, Power and Telecom Coordination Committee (PTCC), defence, civil aviation, right of way / way-leaves and environmental & forest clearances from relevant authorities required for developing, financing, constructing, maintaining/ renewing all such Consents, Clearances and Permits in order to carry out its obligations under this Agreement in general and shall furnish to the Nodal Agency such copy/ies of each Consents, Clearances and Permits, on demand. Nodal Agency shall provide letters of recommendation to the concerned Indian Governmental Instrumentality, as may be requested by the TSP from time to time, for obtaining the Consents, Clearances and Permits required for the Project.

5.1.4 The TSP shall be responsible for:

(a) acquisition of land for location specific substations, switching stations or HVDC terminal or inverter stations. Also, the actual location of Greenfield substations (Switching Stations or HVDC Terminal or Inverter Stations) for a generation pooling substation and for load serving substations in the scope of TSP shall not be beyond 3 Km radius of the location proposed by the BPC in the survey report. However, actual location of any Greenfield Intermediate Substations in the scope of TSP shall not be beyond 10 Km radius of the location proposed by the BPC in the Survey Report.

(b) final selection of Site including its geo-technical investigation;



102

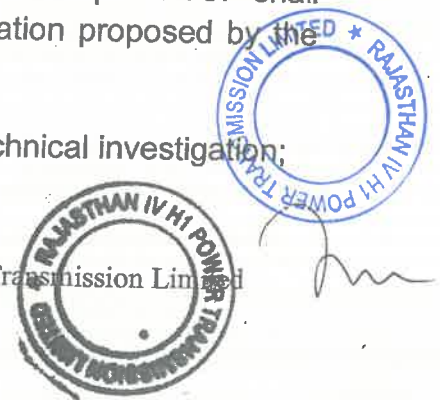



- (c) survey and geo-technical investigation of line route in order to determine the final route of the Transmission Lines;
- (d) seeking access to the Site and other places where the Project is being executed, at its own risk and costs, including payment of any crop, tree compensation or any other compensation as may be required.

5.1.5 In case the Project involves any resettlement and rehabilitation, the resettlement and rehabilitation package will be implemented by the State Government authorities, for which the costs are to be borne by the TSP and no changes would be allowed in the Transmission Charges on account of any variation in the resettlement and rehabilitation cost. The TSP shall provide assistance on best endeavour basis, in implementation of the resettlement and rehabilitation package, if execution of such package is in the interest of expeditious implementation of the Project and is beneficial to the Project affected persons.

## 5.2 Appointing Contractors:

- 5.2.1 The TSP shall conform to the requirements as provided in this Agreement while appointing Contractor(s) for procurement of goods & services.
- 5.2.2 The appointment of such Contractor(s) shall neither relieve the TSP of any of its obligations under this Agreement nor make the Nodal Agency liable for the performance of such Contractor(s).

## 5.3 Monthly Progress Reporting:

The TSP shall provide to the CEA, Nodal Agency & Independent Engineer, on a monthly basis, progress reports along with likely completion date of each Element with regard to the Project and its execution (in accordance with prescribed form). The Nodal Agency/ CEA shall monitor the development of the Project for its timely completion for improving and augmenting the electricity system as a part of its statutory responsibility.

## 5.4 Quality of Workmanship:

The TSP shall ensure that the Project is designed, built and completed in a good workmanship using sound engineering and construction practices, and using only materials and equipment that are new and manufactured as per the MQP and following approved FQP for erection, testing & commissioning and complying with Indian /International Standards such that, the useful life of the Project will be at least thirty five (35) years from the COD of the Project.



103



The TSP shall ensure that all major substation equipment / component (e.g. transformers, reactors, Circuit Breakers, Instrument Transformers (IT), Surge Arresters (SA), Protection relays, clamps & connectors etc.), equipment in terminal stations of HVDC installations including Thyristor/ IGBT valves, Converter Transformers, smoothing reactors, Transformer bushings and wall bushings, GIS bus ducts, towers and gantry structures and transmission towers or poles and line materials (conductors, earth wire, OPGW, insulator, accessories for conductors, OPGW & earth wires, hardware fittings for insulators, aviation lights etc), facilities and system shall be designed, constructed and tested (Type test, Routine tests, Factory Acceptance Test (FAT)) in accordance with relevant CEA Regulations and Indian Standards. In case Indian Standards for any particular equipment/ system/ process is not available, IEC/ IEEE or equivalent International Standards and Codes shall be followed.

**5.5 Progress Monitoring & Quality Assurance:**

- 5.5.1 The Project Execution Plan submitted by the TSP in accordance with Article 3.1.3 c) shall comprise of detailed schedule of all the equipment/items /materials required for the Project, right from procurement of raw material till the dispatch from works and receipt at the site. Further, it should also include various stages of the construction schedule up to the commissioning of the Project.
- 5.5.2 Nodal Agency, CEA & Independent Engineer shall have access at all reasonable times to the Site and to the Manufacturer's works and to all such places where the Project is being executed.
- 5.5.3 Independent Engineer shall ensure conformity of the conductor specifications with the functional specifications specified in RFP.
- 5.5.4 The Independent Engineer shall monitor the following during construction of the Project:
- Quality of equipment, material, foundation, structures and workmanship etc. as laid down in Article 5.4 and 6.1.4 of the TSA. Specifically, quality of Sub-station equipment, transmission line material and workmanship etc. would be checked in accordance with the Article 5.4.
  - Progress in the activities specified in Condition Subsequent
  - Verification of readiness of the elements including the statutory clearances & completion of civil works, fixing of all components and finalisation of punch points (if any) prior to charging of the elements



104



d) Progress of construction of substation and Transmission Lines

5.5.5 The progress shall be reviewed by the Independent Engineer against the Project Execution Plan. The Independent Engineer shall prepare its report on monthly basis and submit the same to Nodal Agency highlighting the progress achieved till the end of respective month vis-à-vis milestone activities, areas of concern, if any, which may result in delay in the timely completion of the Project. Based on the progress, Nodal Agency and/ or CEA shall issue written instructions to the TSP to take corrective measures, as may be prudent for the timely completion of the Project. In case of any deficiency, the Nodal Agency would be at liberty to take action in accordance with the procedure of this Agreement.

5.5.6 For any delay in commissioning any critical Element(s), as identified in Schedule 1 & Schedule 2 of this Agreement, beyond a period of 45 days shall lead to a sequestration of 10% of the Contract Performance Guarantee.

**5.6 Site regulations and Construction Documents**

The TSP shall abide by the Safety Rules and Procedures as mentioned in Schedule 3 of this Agreement

The TSP shall retain at the Site and make available for inspection at all reasonable times, copies of the Consents, Clearances and Permits, construction drawings and other documents related to construction.

**5.7 Supervision of work:**

The TSP shall provide all necessary superintendence for execution of the Project and its supervisory personnel shall be available to provide full-time superintendence for execution of the Project. The TSP shall provide skilled personnel who are experienced in their respective fields.

**5.8 Remedial Measures:**

The TSP shall take all necessary actions for remedying the shortfall in achievement of timely progress in execution of the Project, if any, as intimated by the Independent Engineer and/ or CEA and/ or the Nodal Agency. However, such intimation by the Independent Engineer and/ or CEA and/ or the Nodal Agency and the subsequent effect of such remedial measures carried out by the TSP shall not relieve the TSP of its obligations in the Agreement. Independent Engineer and/ or CEA and/ or the Nodal Agency may carry out random inspections during the Project execution, as and when deemed necessary by it. If the shortfalls as intimated to the TSP are not remedied to the satisfaction of the CEA and/ or the Nodal Agency



105

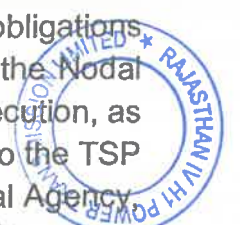
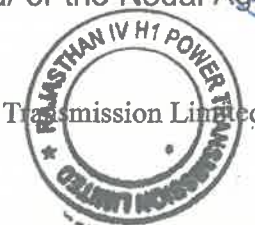

this Agreement may be terminated by the Nodal Agency by giving a Termination Notice to the TSP, in writing, of at least seven (7) days, with a copy to CEA and the Lenders' Representative in order to enable the Lenders to exercise right of substitution in accordance with Article 15.3 of this Agreement.

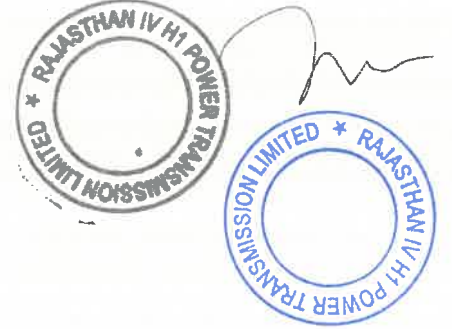



## ARTICLE: 6

### 6 CONNECTION AND COMMISSIONING OF THE PROJECT

#### 6.1 Connection with the Inter-Connection Facilities:

6.1.1 The TSP shall give the RLDC(s), CTU, / STU, as the case may be, and any other agencies as required, at least sixty (60) days advance written notice of the date on which it intends to connect an Element of the Project, which date shall not be earlier than its Scheduled COD or Schedule COD extended as per Article 4.4.1 & 4.4.2 of this Agreement, unless mutually agreed to by Parties. Further, any preponing of COD of any element prior to Scheduled COD must be approved by the Nodal Agency.

6.1.2 The RLDC / SLDC (as the case may be) or the CTU / STU (as the case may be), for reasonable cause, including non-availability of Interconnection Facilities as per Article 4.2, can defer the connection for up to fifteen (15) days from the date notified by the TSP pursuant to Article 6.1.1, if it notifies to the TSP in writing, before the date of connection, of the reason for the deferral and when the connection is to be rescheduled. However, no such deferment on one or more occasions would be for more than an aggregate period of thirty (30) days. Further, the Scheduled COD would be extended as required, for all such deferments on "day to day" basis.

6.1.3 Subject to Articles 6.1.1 and 6.1.2, any Element of Project may be connected with the Interconnection Facilities when:

- a. it has been completed in accordance with this Agreement and the Connection Agreement;
- b. it meets the Grid Code, Central Electricity Authority (Technical Standards for Connectivity to the Grid) Regulations, 2007 as amended from time to time and all other Indian legal requirements, and
- c. The TSP has obtained the approval in writing of the Electrical Inspector certifying that the Element is ready from the point of view of safety of supply and can be connected with the Interconnection Facilities.
- d. It has satisfactorily met all the testing requirements as per Articles 6.1.4

6.1.4 Site Acceptance Test (SAT)/ pre-commissioning tests of all major substation equipment, component, system, facilities shall be successfully carried out before commissioning. The Type tests, FAT and SAT reports

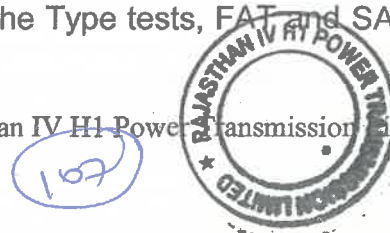

should be available at the substation / terminal station of HVDC installations for ready reference of operation and maintenance staff and has to be made available to the Independent Engineer appointed for quality monitoring or their authorised representatives, as and when they wish to examine the same.

**6.2 Commercial Operation:**

6.2.1 An Element of the Project shall be declared to have achieved COD twenty-four (24) hours following the connection of the Element with the Interconnection Facilities pursuant to Article 6.1 or seven (7) days after the date on which it is declared by the TSP to be ready for charging but is not able to be charged for reasons not attributable to the TSP subject to Article 6.1.2.

Provided that an Element shall be declared to have achieved COD only after all the Element(s), if any, which are pre-required to have achieved COD as defined in Schedule 2 of this Agreement, have been declared to have achieved their respective COD.

6.2.2 Once any Element of the Project has been declared to have achieved deemed COD as per Article 6.2.1 above, such Element of the Project shall be deemed to have Availability equal to the Target Availability till the actual charging of the Element and to this extent, TSP shall be eligible for the Monthly Transmission Charges applicable for such Element

**6.3 Compensation for Direct Non Natural Force Majeure Event or Indirect Non Natural Force Majeure Event or Natural Force Majeure Event (affecting the Nodal Agency)**

6.3.1 If the TSP is otherwise ready to connect the Element(s) of the Project and has given due notice, as per provisions of Article 6.1.1, to the concerned agencies of the date of intention to connect the Element(s) of the Project, where such date is not before the Scheduled COD, but is not able to connect the Element(s) of the Project by the said date specified in the notice, due to Direct Non Natural Force Majeure Event or Indirect Non Natural Force Majeure Event or Natural Force Majeure Event affecting the Nodal Agency, provided such Direct Non Natural Force Majeure Event or Indirect Non Natural Force Majeure Event or Natural Force Majeure Event affecting the Nodal Agency has continued for a period of more than three (3) continuous or non-continuous Months, the TSP shall, until the effects of the Direct Non Natural Force Majeure Event or of Indirect Non Natural Force Majeure Event or Natural Force Majeure Event affecting the Nodal Agency no longer prevent the TSP from connecting the Element(s) of the

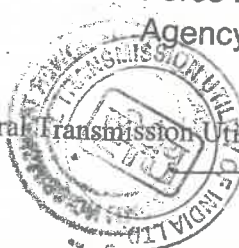

108

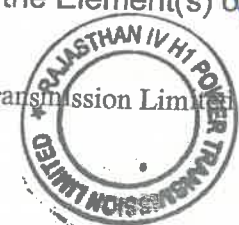

Project, be deemed to have achieved COD relevant to that date and to this extent, be deemed to have been providing Transmission Service with effect from the date notified, and shall be treated as follows:

- a. In case of delay due to Direct Non Natural Force Majeure Event, TSP is entitled for Transmission Charges calculated on Target Availability for the period of such events in excess of three (3) continuous or non-continuous Months in the manner provided in (c) below.
- b. In case of delay due to Indirect Non Natural Force Majeure Event or Natural Force Majeure Event affecting the Nodal Agency, TSP is entitled for payment for debt service which is due under the Financing Agreements, subject to a maximum of Transmission Charges calculated on Target Availability, for the period of such events in excess of three (3) continuous or non-continuous Months in the manner provided in (c) below.
- c. In case of delay due to Direct Non Natural Force Majeure Event or Indirect Non Natural Force Majeure Event or Natural Force Majeure Event affecting the Nodal Agency, the TSP is entitled for payments mentioned in (a) and (b) above, after commencement of Transmission Service, in the form of an increase in Transmission Charges. These amounts shall be paid from the date, being the later of a) the date of cessation of such Indirect Non Natural Force Majeure Event or Natural Force Majeure Event affecting the Nodal Agency and b) the completion of sixty (60) days from the receipt of the Financing Agreements by the Nodal Agency from the TSP. Provided such increase in Transmission Charges shall be so as to put the TSP in the same economic position as the TSP would have been in case the TSP had been paid amounts mentioned in (a) and (b) above in a situation where the Force Majeure Event had not occurred.

For the avoidance of doubt, it is clarified that the charges payable under this Article 6.3.1 shall be recovered as per Sharing Regulations.

#### 6.4 Liquidated Damages for Delay in achieving COD of Project:

- 6.4.1 If the TSP fails to achieve COD of any Element of the Project on the Project, by the Element's / Project's Scheduled COD or such Scheduled COD as extended under Articles 4.4.1 and 4.4.3, then the TSP shall pay to the Nodal Agency, a sum equivalent to 3.33% of Monthly Transmission Charges applicable for the Element of the Project [in case where no

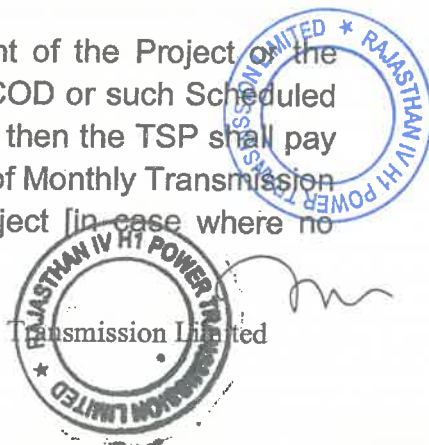



Elements have been defined, to be on the Project as a whole] / Project, for each day of delay up to sixty (60) days of delay and beyond that time limit, at the rate of five percent (5%) of the Monthly Transmission Charges applicable to such Element / Project, as liquidated damages for such delay and not as penalty, without prejudice to any rights of the Nodal Agency under the Agreement.

6.4.2 The TSP's maximum liability under this Article 6.4 shall be limited to the amount of liquidated damages calculated in accordance with Article 6.4.1 for and up to six (6) months of delay for the Element or the Project. Provided that, in case of failure of the TSP to achieve COD of the Element of the Project even after the expiry of six (6) months from its Scheduled COD, the provisions of Article 13 shall apply.

6.4.3 The TSP shall make payment to the Nodal Agency of the liquidated damages calculated pursuant to Article 6.4.1 within ten (10) days of the earlier of:

- a. the date on which the applicable Element achieves COD; or
- b. the date of termination of this Agreement.

The payment of such damages shall not relieve the TSP from its obligations to complete the Project or from any other obligation and liabilities under the Agreement.

6.4.4 If the TSP fails to pay the amount of liquidated damages to the Nodal Agency within the said period of ten (10) days, the Nodal Agency shall be entitled to recover the said amount of the liquidated damages by invoking the Contract Performance Guarantee. If the then existing Contract Performance Guarantee is for an amount which is less than the amount of the liquidated damages payable by the TSP to the Nodal Agency under this Article 6.3 and the TSP fails to make payment of the balance amount of the liquidated damages not covered by the Contract Performance Guarantee, then such balance amount shall be deducted from the Transmission Charges payable to the TSP. The right of the Nodal Agency to encash the Contract Performance Guarantee is without prejudice to the other rights of the Nodal Agency under this Agreement.

6.4.5 For avoidance of doubt, it is clarified that amount payable by TSP under this Article is over and above the penalty payable by TSP under Article 5.5.6 of this Agreement.

## 6.5 Return of Contract Performance Guarantee

6.5.1 The Contract Performance Guarantee as submitted by TSP in accordance

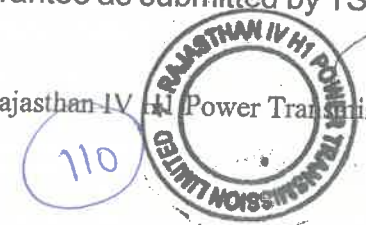



with Article 3.1.1 shall be released by the Nodal Agency within three (3) months from the COD of the Project. In the event of delay in achieving Scheduled COD of any of the Elements by the TSP (otherwise than due to reasons as mentioned in Article 3.1.3 or Article 11) and consequent part invocation of the Contract Performance Guarantee by the Nodal Agency, Nodal Agency shall release the Contract Performance Guarantee, if any remaining unadjusted, after the satisfactory completion by the TSP of all the requirements regarding achieving the Scheduled COD of the remaining Elements of the Project. It is clarified that the Nodal Agency shall also return / release the Contract Performance Guarantee in the event of (i) applicability of Article 3.3.2 to the extent the Contract Performance Guarantee is valid for an amount in excess of Rs. 89.00 Crore (Rupees Eighty Nine Crore only), or (ii) termination of this Agreement by the Nodal Agency as mentioned under Article 3.3.4 of this Agreement.

6.5.2 The release of the Contract Performance Guarantee shall be without prejudice to other rights of the Nodal Agency under this Agreement.



111



**ARTICLE: 7**

**7 OPERATION AND MAINTENANCE OF THE PROJECT**

**7.1 Operation and Maintenance of the Project:**

The TSP shall be responsible for ensuring that the Project is operated and maintained in accordance with the regulations made by the Commission and CEA from time to time and provisions of the Act.

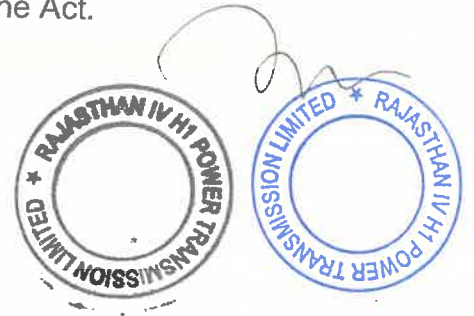

112

**ARTICLE: 8**

**8 AVAILABILITY OF THE PROJECT**

**8.1 Calculation of Availability of the Project:**

Calculation of Availability for the Elements and for the Project, as the case may be, shall be as per Appendix –IV to Central Electricity Regulatory Commission (Terms and Conditions of Tariff) Regulations, 2024, as applicable on the Bid Deadline and as appended in Schedule 6 of this Agreement.

**8.2 Target Availability:**

The Target Availability of each Element and the Project shall be 98%. Payment of monthly Transmission charges based on actual availability will be calculated as per para 1.2 of Schedule 4 of this Agreement. If the availability of any Element or the Project is below the Target Availability, for six consecutive months in a Contract Year, the DIC(s) or the Nodal Agency may issue a show cause notice to the TSP, asking them to show cause as to why the Transmission Service Agreement be not terminated, and if no satisfactory cause is shown it may terminate the Agreement. If the Nodal Agency is of the opinion that the transmission system is of critical importance, it may carry out or cause to carry the operation and maintenance of transmission system at the risk and cost of TSP.

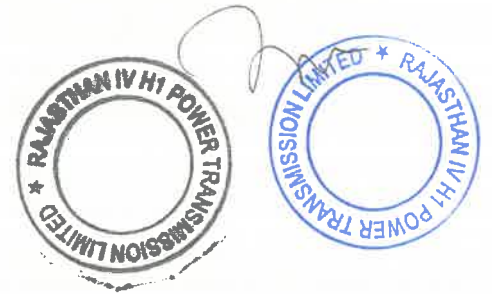

113

**ARTICLE: 9**

**9 INSURANCES**

**9.1 Insurance:**

- 9.1.1 The TSP shall effect and maintain or cause to be effected and maintained during the Construction Period and the Operating Period, adequate Insurances against such risks, with such deductibles including but not limited to any third party liability and endorsements and co-beneficiary/insured, as may be necessary under
- a. any of the Financing Agreements,
  - b. the Laws, and
  - c. in accordance with Prudent Utility Practices.

The Insurances shall be taken effective from a date prior to the date of the Financial Closure till the Expiry Date.

**9.2 Evidence of Insurance cover:**

- 9.2.1 The TSP shall furnish to the Nodal Agency copies of certificates and policies of the Insurances, as and when the Nodal Agency may seek from the TSP as per the terms of Article 9.1

**9.3 Application of Insurance Proceeds:**

- 9.3.1 Save as expressly provided in this Agreement, the policies of Insurances and the Financing Agreements, the proceeds of any insurance claim made due to loss or damage to the Project or any part of the Project shall be first applied to reinstatement, replacement or renewal of such loss or damage.
- 9.3.2 If a Natural Force Majeure Event renders the Project no longer economically and technically viable and the insurers under the Insurances make payment on a "total loss" or equivalent basis, the portion of the proceeds of such Insurance available to the TSP (after making admissible payments to the Lenders as per the Financing Agreements) shall be allocated only to the TSP. Nodal Agency and / or concerned Designated ISTS Customers shall have no claim on such proceeds of the Insurance.
- 9.3.3 Subject to the requirements of the Lenders under the Financing Agreements, any dispute or difference between the Parties as to whether the Project is no longer economically and technically viable due to a Force Majeure Event or whether that event was adequately covered in accordance with this Agreement by the Insurances shall be determined in



114





accordance with Article 16.

**9.4 Effect on liability of the Nodal Agency / Designated ISTS Customers**

9.4.1 The Nodal Agency and / or the Designated ISTS Customers shall have no financial obligations or liability whatsoever towards the TSP in respect of this Article 9.



**ARTICLE: 10**

**10 BILLING AND PAYMENT OF TRANSMISSION CHARGES**

**10.1** Subject to provisions of this Article 10, the Monthly Transmission Charges shall be paid to the TSP, in Indian Rupees, on monthly basis as per the provisions of the Sharing Regulations, from the date on which an Element(s) has achieved COD until the Expiry Date of this Agreement, unless terminated earlier and in line with the provisions of Schedule 4 of this Agreement.

**10.2 Calculation of Monthly Transmission Charges:**

The Monthly Transmission Charges for each Contract Year including Incentive & Penalty payment shall be calculated in accordance with the provisions of Schedule 4 of this Agreement.

**10.3 Rebate & Late Payment Surcharge:**

The rebate and late payment surcharge shall be governed as per Sharing Regulations.

**10.4 Disputed Bills, Default in payment by the Designated ISTS Customers & Annual Reconciliation:**

Any Disputed Bill, Default in payment by the Designated ISTS Customers & Annual Reconciliation shall be governed as per Sharing Regulations.



116

**ARTICLE: 11**

**11 FORCE MAJEURE**

**11.1 Definitions**

11.1.1 The following terms shall have the meanings given hereunder.

**11.2 Affected Party**

11.2.1 An Affected Party means any Party whose performance has been affected by an event of Force Majeure.

11.2.2 Any event of Force Majeure shall be deemed to be an event of Force Majeure affecting the TSP only if the Force Majeure event affects and results in, late delivery of machinery and equipment for the Project or construction, completion, commissioning of the Project by Scheduled COD and/or operation thereafter;

**11.3 Force Majeure**

A 'Force Majeure' means any event or circumstance or combination of events and circumstances including those stated below that wholly or partly prevents or unavoidably delays an Affected Party in the performance of its obligations/ roles under this Agreement, but only if and to the extent that such events or circumstances are not within the reasonable control, directly or indirectly, of the Affected Party and could not have been avoided if the Affected Party had taken reasonable care or complied with Prudent Utility Practices:

**(a) Natural Force Majeure Events:**

- i. act of God, including, but not limited to drought, fire and explosion (to the extent originating from a source external to the Site), earthquake, volcanic eruption, landslide, flood, cyclone, typhoon, tornado, or exceptionally adverse weather conditions, which are in excess of the statistical measures for the last hundred (100) years; and
- ii. epidemic/ pandemic notified by Indian Governmental Instrumentality.

**(b) Non-Natural Force Majeure Events :**

**i. Direct Non-Natural Force Majeure Events**

- Nationalization or compulsory acquisition by any Indian



11



Governmental Instrumentality of any material assets or rights of the Affected Party; or

- the unlawful, unreasonable or discriminatory revocation of, or refusal to renew, any Consents, Clearances and Permits required by the Affected Party to perform their obligations/ roles under the RFP Project Documents or any unlawful, unreasonable or discriminatory refusal to grant any other Consents, Clearances and Permits required for the development/ operation of the Project, provided that a Competent Court of Law declares the revocation or refusal to be unlawful, unreasonable and discriminatory and strikes the same down; or
- any other unlawful, unreasonable or discriminatory action on the part of an Indian Governmental Instrumentality which is directed against the Project, provided that a Competent Court of Law declares the action to be unlawful, unreasonable and discriminatory and strikes the same down.

ii. Indirect Non - Natural Force Majeure Events

- act of war (whether declared or undeclared), invasion, armed conflict or act of foreign enemy, blockade, embargo, revolution, riot, insurrection, terrorist or military action; or
- radioactive contamination or ionizing radiation originating from a source in India or resulting from any other Indirect Non Natural Force Majeure Event mentioned above, excluding circumstances where the source or cause of contamination or radiation is brought or has been brought into or near the Site by the Affected Party or those employed or engaged by the Affected Party; or
- industry-wide strikes and labour disturbances, having a nationwide impact in India.

**11.4 Force Majeure Exclusions**

11.4.1 Force Majeure shall not include (i) any event or circumstance which is within the reasonable control of the Parties and (ii) the following conditions, except to the extent that they are consequences of an event of Force Majeure:



118



- (a) Unavailability, late delivery, or changes in cost of the machinery, equipment, materials, spare parts etc. for the Project;
- (b) Delay in the performance of any Contractors or their agents;
- (c) Non-performance resulting from normal wear and tear typically experienced in transmission materials and equipment;
- (d) Strikes or labour disturbance at the facilities of the Affected Party;
- (e) Insufficiency of finances or funds or the Agreement becoming onerous to perform; and
- (f) Non-performance caused by, or connected with, the Affected Party's:
  - i. negligent or intentional acts, errors or omissions;
  - ii. failure to comply with an Indian Law; or
  - iii. breach of, or default under this Agreement or any Project Documents.
- (g) Any error or omission in the survey report provided by BPC during the bidding process.

## 11.5 Notification of Force Majeure Event

11.5.1 The Affected Party shall give notice to the other Party of any event of Force Majeure as soon as reasonably practicable, but not later than seven (7) days after the date on which such Party knew or should reasonably have known of the commencement of the event of Force Majeure. If an event of Force Majeure results in a breakdown of communications rendering it unreasonable to give notice within the applicable time limit specified herein, then the Party claiming Force Majeure shall give such notice as soon as reasonably practicable after reinstatement of communications, but not later than one (1) day after such reinstatement.

Provided that, such notice shall be a pre-condition to the Affected Party's entitlement to claim relief under this Agreement. Such notice shall include full particulars of the event of Force Majeure, its effects on the Party claiming relief and the remedial measures proposed. The Affected Party shall give the other Party regular reports on the progress of those remedial measures and such other information as the other Party may reasonably request about the Force Majeure.

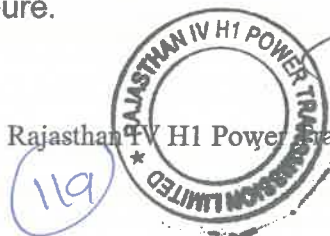

- 11.5.2 The Affected Party shall give notice to the other Party of (i) the cessation of the relevant event of Force Majeure; and (ii) the cessation of the effects of such event of Force Majeure on the performance of its rights or obligations/ roles under this Agreement, as soon as practicable after becoming aware of each of these cessations.

**11.6 Duty to perform and duty to mitigate**

To the extent not prevented by a Force Majeure Event, the Affected Party shall continue to perform its obligations/ roles as provided in this Agreement. The Affected Party shall use its reasonable efforts to mitigate the effect of any event of Force Majeure as soon as practicable.

**11.7 Available Relief for a Force Majeure Event**

Subject to this Article 11,

- (a) no Party shall be in breach of its obligations/ roles pursuant to this Agreement to the extent that the performance of its obligations/ roles was prevented, hindered or delayed due to a Force Majeure Event;
- (b) each Party shall be entitled to claim relief for a Force Majeure Event affecting its performance in relation to its obligations/ roles under Articles 3.3.4, 4.4.2 and 6.3.1 of this Agreement.
- (c) For the avoidance of doubt, it is clarified that the computation of Availability of the Element(s) under outage due to Force Majeure Event, as per Article 11.3 affecting the TSP shall be as per Appendix –IV to Central Electricity Regulatory Commission (Terms and Conditions of Tariff) Regulations, 2024 as on Bid Deadline. For the event(s) for which the Element(s) is/are deemed to be available as per Appendix –IV to Central Electricity Regulatory Commission (Terms and Conditions of Tariff) Regulations, 2024, then the Transmission Charges, as applicable to such Element(s), shall be payable as per Schedule 4, for the duration of such event(s).
- (d) For so long as the TSP is claiming relief due to any Force Majeure Event under this Agreement, the Nodal Agency may, if it so desires, from time to time on one (1) day notice, inspect the Project and the TSP shall provide the Nodal Agency's personnel with access to the Project to carry out such inspections.
- (e) For avoidance of doubt, the TSP acknowledges that for extension of Scheduled COD a period up to one hundred eighty (180) days due to

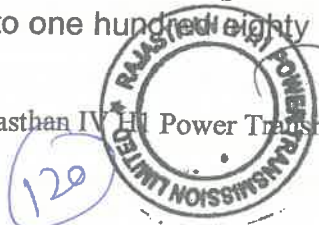
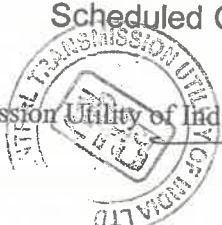

Transmission Service Agreement

Force Majeure event, no compensation on the grounds such as interest cost, incident expenditure, opportunity cost will be made to the TSP. However, if Scheduled COD is extended beyond a period of one hundred eighty (180) days due to Force Majeure event, the TSP will be allowed to recover the interest cost during construction corresponding to the period exceeding one hundred eighty (180) days by adjustment in the Transmission Charges in accordance with Schedule 9.



**ARTICLE: 12**

**12 CHANGE IN LAW**

**12.1 Change in Law**

12.1.1 Change in Law means the occurrence of any of the following after the Bid Deadline resulting into any additional recurring / non-recurring expenditure by the TSP or any savings of the TSP:

- the enactment, coming into effect, adoption, promulgation, amendment, modification or repeal (without re-enactment or consolidation) in India, of any Law, including rules and regulations framed pursuant to such Law, subject to the provisions under Article 12.1.2;
- a change in the interpretation or application of any Law by any Indian Governmental Instrumentality having the legal power to interpret or apply such Law, or any Competent Court of Law;
- the imposition of a requirement for obtaining any Consents, Clearances and Permits which was not required earlier;
- a change in the terms and conditions prescribed for obtaining any Consents, Clearances and Permits or the inclusion of any new terms or conditions for obtaining such Consents, Clearances and Permits;
- any change in the licensing regulations of the Commission, under which the Transmission License for the Project was granted if made applicable by such Commission to the TSP;
- change in wind zone; or
- any change in tax or introduction of any tax made applicable for providing Transmission Service by the TSP as per the terms of this Agreement.

12.1.2 Notwithstanding anything contained in this Agreement, Change in Law shall not cover any change:

- a) Taxes on corporate income; and
- b) Withholding tax on income or dividends distributed to the shareholders of the TSP.



122



## 12.2 Relief for Change in Law

12.2.1 During Construction Period, the impact of increase/decrease in the cost of the Project on the Transmission Charges shall be governed by the formula given in Schedule 9 of this Agreement.

12.2.2 During the Operation Period:  
During the operation period, if as a result of Change in Law, the TSP suffers or is benefited from a change in costs or revenue, the aggregate financial effect of which exceeds 0.30% (zero point three percent) of the Annual Transmission Charges in aggregate for a Contract Year, the TSP may notify so to the Nodal Agency and propose amendments to this Agreement so as to place the TSP in the same financial position as it would have enjoyed had there been no such Change in Law resulting in change in costs or revenue as aforesaid.

12.2.3 For any claims made under Articles 12.2.1 and 12.2.2 above, the TSP shall provide to the Nodal Agency documentary proof of such increase / decrease in cost of the Project / revenue for establishing the impact of such Change in Law.

In cases where Change in Law results in decrease of cost and it comes to the notice of Nodal Agency that TSP has not informed Nodal Agency about such decrease in cost, Nodal Agency may initiate appropriate claim.

## 12.3 Notification of Change in Law:

12.3.1 If the TSP is affected by a Change in Law in accordance with Article 12.1 and wishes to claim relief for such Change in Law under this Article 12, it shall give notice to Nodal Agency of such Change in Law as soon as reasonably practicable after becoming aware of the same.

12.3.2 The TSP shall also be obliged to serve a notice to the Nodal Agency even when it is beneficially affected by a Change in Law.

12.3.3 Any notice served pursuant to Articles 12.3.1 and 12.3.2 shall provide, amongst other things, precise details of the Change in Law and its estimated impact on the TSP.

## 12.4 Payment on account of Change in Law

12.4.1 The payment for Change in Law shall be through a separate Bill. However, in case of any change in Monthly Transmission Charges by reason of Change in Law, as determined in accordance with this Agreement, the Bills to be raised by the Nodal Agency after such change in Transmission

Transmission Service Agreement

Charges shall appropriately reflect the changed Monthly Transmission Charges.



Central Transmission Utility of India Limited



*[Handwritten signature]*



51 Rajasthan IV HT Power Transmission Limited

124

## ARTICLE: 13

### 13 EVENTS OF DEFAULT AND TERMINATION

#### 13.1 TSP's Event of Default

The occurrence and continuation of any of the following events shall constitute a TSP Event of Default, unless any such TSP Event of Default occurs as a result of any non-fulfilment of its obligations as prescribed under this Agreement by the Nodal Agency or a Force Majeure Event:

- a. After having taken up the construction of the Project, the abandonment by the TSP or the TSP's Contractors of the construction of the Project for a continuous period of two (2) months and such default is not rectified within thirty (30) days from the receipt of notice from the Nodal Agency in this regard;
- b. The failure to commission any Element of the Project by the date falling six (6) months after its Scheduled COD unless extended by Nodal Agency as per provisions of this Agreement;
- c. If the TSP:
  - i. assigns, mortgages or charges or purports to assign, mortgage or charge any of its assets or rights related to the Project in contravention of the provisions of this Agreement; or
  - ii. transfers or novates any of its obligations pursuant to this Agreement, in a manner contrary to the provisions of this Agreement;

Except where such transfer is in pursuance of a Law and

- it does not affect the ability of the transferee to perform, and such transferee has the financial and technical capability to perform, its obligations under this Agreement;
- is to a transferee who assumes such obligations under the Project and this Agreement remains effective with respect to the transferee;



128

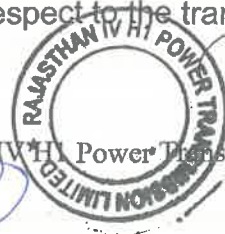

d. If:

- i. The TSP becomes voluntarily or involuntarily the subject of any bankruptcy or insolvency or winding up proceedings and such proceedings remain uncontested for a period of thirty (30) days; or
- ii. any winding up or bankruptcy or insolvency order is passed against the TSP; or
- iii. the TSP goes into liquidation or dissolution or a receiver or any similar officer is appointed over all or substantially all of its assets or official liquidator is appointed to manage its affairs, pursuant to Law,

Provided that a dissolution or liquidation of the TSP will not be a TSP's Event of Default, where such dissolution or liquidation of the TSP is for the purpose of a merger, consolidation or reorganization with the prior approval of the Commission as per the provisions of Central Electricity Regulatory Commission (Procedure, terms and Conditions for grant of Transmission License and other related matters) Regulations, 2006 or as amended from time to time; or

- e. Failure on the part of the TSP to comply with the provisions of Article 19.1 of this Agreement; or
- f. the TSP repudiates this Agreement and does not rectify such breach even within a period of thirty (30) days from a notice from the Nodal Agency in this regard; or
- g. after Commercial Operation Date of the Project, the TSP fails to achieve monthly Target Availability of 98%, for a period of six (6) consecutive months or within a non-consecutive period of six (6) months within any continuous aggregate period of eighteen(18) months except where the Availability is affected by Force Majeure Events as per Article 11; or

h. any of the representations and warranties made by the TSP in Article 17 of this Agreement being found to be untrue or



126

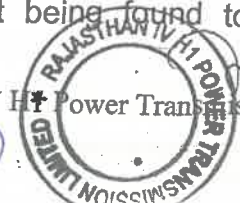



inaccurate. Further, in addition to the above, any of the undertakings submitted by the Selected Bidder at the time of submission of the Bid being found to be breached or inaccurate, including but not limited to undertakings from its Parent Company / Affiliates related to the minimum equity obligation; or

- i. the TSP fails to complete / fulfil all the activities / conditions within the specified period as per Article 3; or
- j. except for the reasons solely attributable to Nodal Agency, the TSP is in material breach of any of its obligations under this Agreement and such material breach is not rectified by the TSP within thirty (30) days of receipt of notice in this regard from the Nodal Agency; or
- k. the TSP fails to take the possession of the land required for location specific substations, switching stations or HVDC terminal or inverter stations and / or fails to pay the requisite price to the parties and / or any State Government authority from whom the land is acquired, within twelve (12) months from the Effective Date.

### **13.2 Termination Procedure for TSP Event of Default**

- a. Upon the occurrence and continuance of any TSP's Event of Default under Article 13.1 the Nodal Agency may serve notice on the TSP, with a copy to the CEA and the Lenders' Representative, of their intention to terminate this Agreement (a "Nodal Agency's Preliminary Termination Notice"), which shall specify in reasonable detail, the circumstances giving rise to such Nodal Agency's Preliminary Termination Notice.
- b. Following the issue of a Nodal Agency's Preliminary Termination Notice, the Consultation Period shall apply and would be for the Parties to discuss as to what steps shall be taken with a view to mitigate the consequences of the relevant Event of Default having regard to all the circumstances.
- c. During the Consultation Period, the Parties shall, save as otherwise provided in this Agreement, continue to perform their respective obligations/ roles under this Agreement, and the TSP shall not remove any material, equipment or any part of the Project, without prior consent of the Nodal Agency.

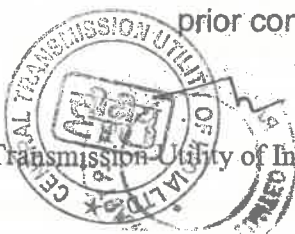

Following the expiry of the Consultation Period, unless the Parties shall have otherwise agreed to the contrary or the circumstances giving rise to Nodal Agency's Preliminary Termination Notice shall have ceased to exist or shall have been remedied, this Agreement may be terminated by the Nodal Agency by giving a Termination Notice to the TSP, in writing, of at least seven (7) days, with a copy to CEA and the Lenders' Representative in order to enable the Lenders to exercise right of substitution in accordance with Article 15.3 of this Agreement.

Further, the Nodal Agency may also initiate proceedings to blacklist the TSP & its Affiliates from participation in any RFP issued by BPCs for a period of 5 years.

**13.3 Procedure for Nodal Agency's non-fulfilment of Role**

- a. Upon the Nodal Agency not being able to fulfil its role under Article 4.2, the TSP may serve notice on the Nodal Agency, with a copy to CEA and the Lenders' Representative (a "TSP's Preliminary Notice"), which notice shall specify in reasonable detail the circumstances giving rise to such non-fulfilment of role by the Nodal Agency.
- b. Following the issue of a TSP's Preliminary Notice, the Consultation Period shall apply.
- c. The Consultation Period would be for the Parties to discuss as to what steps shall be taken with a view to mitigate the consequences of the relevant non-fulfilment of role by the Nodal Agency including giving time extension to TSP, having regard to all the circumstances.
- d. During the Consultation Period, both Parties shall, save as otherwise provided in this Agreement, continue to perform their respective obligations/ roles under this Agreement.

**13.4 Termination due to Force Majeure**

13.4.1 In case the Parties could not reach an agreement pursuant to Articles 3.3.4 and 4.4.2 of this Agreement and the Force Majeure Event or its effects continue to be present, the Nodal Agency shall have the right to cause termination of the Agreement. In case of such termination, the Contract Performance Guarantee shall be returned to the TSP as per the provisions of Article 6.5.1.

13.4.2 In case of termination of this Agreement, the TSP shall provide to the Nodal Agency the full names and addresses of its Contractors as well as complete designs, design drawings, manufacturing drawings, material

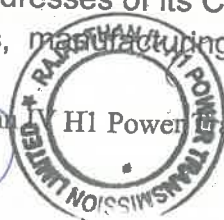
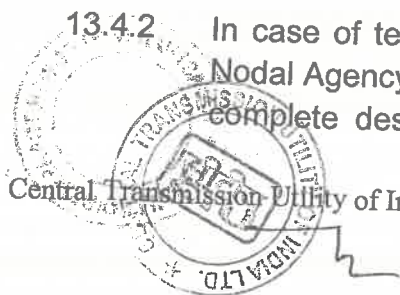

specifications and technical information, as required by the Nodal Agency within thirty (30) days of Termination Notice.

**13.5 Termination or amendment due to non-requirement of any Element or Project during construction**

13.5.1 In case any Element or Project, which is under construction, is no longer required due to any reason whatsoever, the Nodal Agency may issue a notice to this effect to the TSP.

13.5.2 Nodal agency may also issue notice to the TSP seeking their response to the proposed termination/ amendment (as the case may be) of the Agreement. The Nodal Agency shall issue copy of such notice to Lenders. In the notice, Nodal Agency shall also include an assessment of the physical progress made by TSP in the Element/ Project (as the case may be) that is no longer required.

13.5.3 The TSP shall neither carry out further investment nor carry out any work on the Element/ Project (as the case may be) that is no longer required after delivery of the notice.

13.5.4 After taking into account the comments of the TSP, the Nodal Agency may terminate the Agreement or amend it if both Parties agree to the amendment.

**13.6 Revocation of the Transmission License**

13.6.1 The Commission may, as per the provisions of the Electricity Act, 2003, revoke the Transmission License of the ISTS Licensee. Further, in such a case, the Agreement shall be deemed to have been terminated.

**13.7 Termination Payment**

13.7.1 If Agreement is terminated on account of Force Majeure Events, non-requirement of any Element or Project during Construction, Nodal Agency's non-fulfilment of Role & TSP's Event of Default, the TSP shall be entitled for Termination Payment equivalent to valuation of Project Assets. Upon payment, the Nodal Agency shall take over the Project Assets.



129

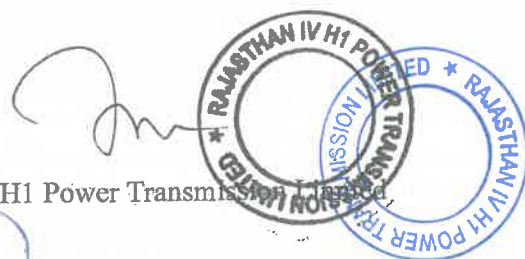

**ARTICLE: 14**

**14 LIABILITY AND INDEMNIFICATION**

**14.1 Indemnity**

14.1.1 The TSP shall indemnify, defend and hold the Nodal Agency harmless against:

- (a) any and all third party claims, actions, suits or proceedings against the Nodal Agency for any loss of or damage to property of such third party, or death or injury to such third party, arising out of a breach by the TSP of any of its obligations under this Agreement, except to the extent that any such claim, action, suit or proceeding has arisen due to a negligent act or omission, breach of this Agreement or non-fulfilment of statutory duty on the part of Nodal Agency; and
- (b) any and all losses, damages, costs and expenses including legal costs, fines, penalties and interest actually suffered or incurred by the Nodal Agency from third party claims arising by reason of:
  - i. a breach by the TSP of any of its obligations under this Agreement, (provided that this Article 14 shall not apply to such breaches by the TSP, for which specific remedies have been provided for under this Agreement) except to the extent that any such losses, damages, costs and expenses including legal costs, fines, penalties and interest (together to constitute "Indemnifiable Losses") has arisen due to a negligent act or omission, breach of this Agreement or non-fulfilment of statutory duty on the part of the Nodal Agency, or
  - ii. any of the representations and warranties of the TSP under this Agreement being found to be inaccurate or untrue.

14.1.2 The Nodal Agency shall, in accordance with the Regulations framed by CERC in this regard, indemnify, defend and hold the TSP harmless against:

- (a) any and all third party claims, actions, suits or proceedings against the TSP, for any loss of or damage to property of such third party, or death or injury to such third party, arising out of any material breach by the Nodal Agency of any of their roles under this Agreement, except to the extent that any such claim, action, suit or proceeding has arisen due to a negligent act or omission, breach of this

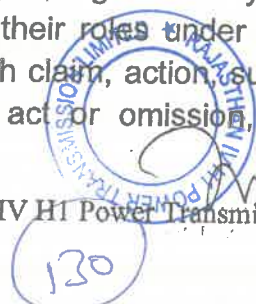
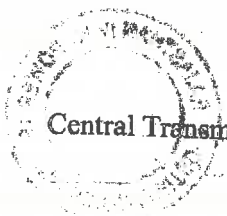



Agreement or breach of statutory duty on the part of the TSP, its Contractors, servants or agents; and

- (b) any and all losses, damages, costs and expenses including legal costs, fines, penalties and interest ('Indemnifiable Losses') actually suffered or incurred by the TSP from third party claims arising by reason of:
- i. any material breach by the Nodal Agency of any of its roles under this Agreement (provided that, this Article 14 shall not apply to such breaches by the Nodal Agency, for which specific remedies have been provided for under this Agreement), except to the extent that any such Indemnifiable Losses have arisen due to a negligent act or omission, breach of this Agreement or breach of statutory duty on the part of the TSP, its Contractors, servants or agents or
  - ii. any of the representations and warranties of the Nodal Agency under this Agreement being found to be inaccurate or untrue.

**14.2 Patent Indemnity:**

**14.2.1**

- (a) The TSP shall, subject to the Nodal Agency's compliance with Article 14.2.1 (b), indemnify and hold harmless the Nodal Agency and its employees and officers from and against any and all suits, actions or administrative proceedings, claims, demands, losses, damages, costs, and expenses of whatsoever nature, including attorney's fees and expenses, which the Nodal Agency may suffer as a result of any infringement or alleged infringement of any patent, utility model, registered design, trademark, copyright or other intellectual property right registered or otherwise existing at the date of the Agreement by reason of the setting up of the Project by the TSP.

Such indemnity shall not cover any use of the Project or any part thereof other than for the purpose indicated by or to be reasonably inferred from the Agreement, any infringement resulting from the misuse of the Project or any part thereof, or any products produced in association or combination with any other equipment, plant or materials not supplied by the TSP, pursuant to the Agreement.

- (b) If any proceedings are brought or any claim is made against the Nodal Agency arising out of the matters referred to in Article

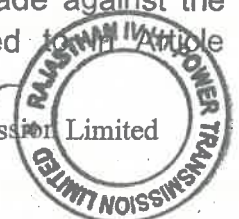
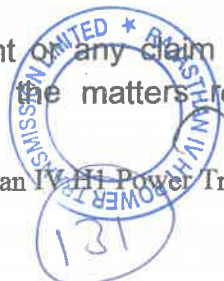

14.2.1(a), the Nodal Agency shall promptly give the TSP a notice thereof, and the TSP shall at its own expense take necessary steps and attend such proceedings or claim and any negotiations for the settlement of any such proceedings or claim. The TSP shall promptly notify the Nodal Agency of all actions taken in such proceedings or claims.

- (c) If the TSP fails to notify the Nodal Agency within twenty-eight (28) days after receipt of such notice from the Nodal Agency under Article 14.2.1(b) above, that it intends to attend any such proceedings or claim, then the Nodal Agency shall be free to attend the same on their own behalf at the cost of the TSP. Unless the TSP has so failed to notify the Nodal Agency within the twenty eight (28) days period, the Nodal Agency shall make no admission that may be prejudicial to the defence of any such proceedings or claims.
- (d) The Nodal Agency shall, at the TSP's request, afford all available assistance to the TSP in attending to such proceedings or claim, and shall be reimbursed by the TSP for all reasonable expenses incurred in so doing.

14.2.2

- (a) The Nodal Agency, in accordance with the Regulations framed by CERC in this regard, subject to the TSP's compliance with Article 14.2.2(b) shall indemnify and hold harmless the TSP and its employees, officers from and against any and all suits, actions or administrative proceedings, claims, demands, losses, damages, costs and expenses of whatsoever nature, including attorney's fees and expenses, which the TSP may suffer as a result of any infringement or alleged infringement of any patent, utility model, registered design, trademark, copyright or other intellectual property right registered or otherwise existing at the date of the Agreement by reason of the setting up of the Project by the TSP.
- (b) If any proceedings are brought or any claim is made against the TSP arising out of the matters referred to in Article 14.2.2 (a) the TSP shall promptly give the Nodal Agency a notice thereof, and the Nodal Agency shall at its own expense take necessary steps and attend such proceedings or claim and any negotiations for the settlement of any such proceedings or claim. The Nodal Agency shall promptly notify the TSP of all actions taken in such proceedings or claims.



Central Transmission Utility of India Limited



- (c) If the Nodal Agency fails to notify the TSP within twenty-eight (28) days after receipt of such notice from the TSP under Article 14.2.2(b) above, that it intends to attend any such proceedings or claim, then the TSP shall be free to attend the same on its own behalf at the cost of the Nodal Agency. Unless the Nodal Agency has so failed to notify the TSP within the twenty (28) days period, the TSP shall make no admission that may be prejudicial to the defence of any such proceedings or claim.
- (d) The TSP shall, at the Nodal Agency request, afford all available assistance to the Nodal Agency in attending to such proceedings or claim, and shall be reimbursed by the Nodal Agency for all reasonable expenses incurred in so doing.

### 14.3 Monetary Limitation of liability

- 14.3.1 A Party ("Indemnifying Party") shall be liable to indemnify the other Party ("Indemnified Party") under this Article 14 for any indemnity claims made in a Contract Year only up to an amount of Rs. 5.93 Crore (Rupees Five Crore Ninety-Three Lakh Only).

### 14.4 Procedure for claiming indemnity

- 14.4.1 Where the Indemnified Party is entitled to indemnification from the Indemnifying Party pursuant to Articles 14.1 or 14.2 the Indemnified Party shall promptly notify the Indemnifying Party of such claim, proceeding, action or suit referred to in Articles 14.1 or 14.2 in respect of which it is entitled to be indemnified. Such notice shall be given as soon as reasonably practicable after the Indemnified Party becomes aware of such claim, proceeding, action or suit. The Indemnifying Party shall be liable to settle the indemnification claim within thirty (30) days of receipt of the above notice.

Provided however that, if:

- i. the Parties choose to contest, defend or litigate such claim, action, suit or proceedings in accordance with Article 14.4.3 below; and
- ii. the claim amount is not required to be paid/deposited to such third party pending the resolution of the Dispute,

the Indemnifying Party shall become liable to pay the claim amount to the Indemnified Party or to the third party, as the case may be, promptly following the resolution of the Dispute, if such Dispute is not settled

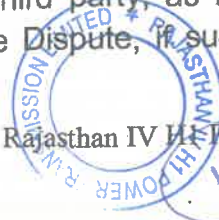

favour of the Indemnified Party.

- 14.4.2 The Indemnified Party may contest, defend and litigate a claim, action, suit or proceeding for which it is entitled to be indemnified under Articles 14.1 or 14.2 and the Indemnifying Party shall reimburse to the Indemnified Party all reasonable costs and expenses incurred by the Indemnified Party. However, such Indemnified Party shall not settle or compromise such claim, action, suit or proceedings without first getting the consent of the Indemnifying Party, which consent shall not be unreasonably withheld or delayed.
- 14.4.3 An Indemnifying Party may, at its own expense, assume control of the defence of any proceedings brought against the Indemnified Party if it acknowledges its obligation to indemnify such Indemnified Party, gives such Indemnified Party prompt notice of its intention to assume control of the defence, and employs an independent legal counsel at its own cost that is reasonably satisfactory to the Indemnified Party.

#### 14.5 Limitation on Liability

- 14.5.1 Except as expressly provided in this Agreement, neither the TSP nor the Nodal Agency nor their respective officers, directors, agents, employees or Affiliates (including, officers, directors, agents or employees of such Affiliates), shall be liable or responsible to the other Party or its Affiliates including its officers, directors, agents, employees, successors, insurers or permitted assigns for incidental, indirect or consequential, punitive or exemplary damages, connected with or resulting from performance or non-performance of this Agreement, or anything done in connection herewith, including claims in the nature of lost revenues, income or profits (other than payments expressly required and properly due under this Agreement), any increased expense of, reduction in or loss of transmission capacity or equipment used therefore, irrespective of whether such claims are based upon breach of warranty, tort (including negligence, whether of the Nodal Agency, the TSP or others), strict liability, contract, breach of statutory duty, operation of law or otherwise.
- 14.5.2 The Nodal Agency shall have no recourse against any officer, director or shareholder of the TSP or any Affiliate of the TSP or any of its officers, directors or shareholders for such claims excluded under this Article. The TSP shall also have no recourse against any officer, director or shareholder of the Nodal Agency, or any Affiliate of the Nodal Agency or any of its officers, directors or shareholders for such claims excluded under this Article.



134



**14.6 Duty to Mitigate**

The party entitled to the benefit of an indemnity under this Article 14 shall take all reasonable measures to mitigate any loss or damage which has occurred. If the Party fails to take such measures, the other Party's liabilities shall be correspondingly reduced.

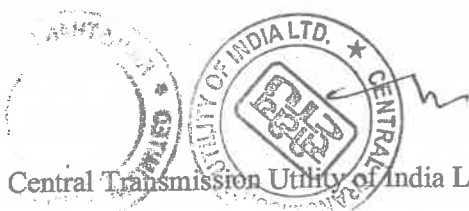
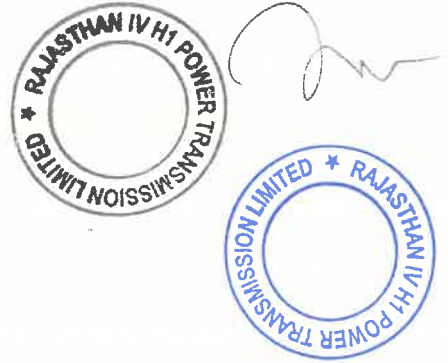

135

**ARTICLE: 15**

**15 ASSIGNMENTS AND CHARGES**

**15.1 Assignments:**

15.1.1 This Agreement shall be binding upon, and inure to the benefit of the Parties and their respective successors and permitted assigns. This Agreement shall not be assigned by any Party, except as provided in Article 15.3.

**15.2 Permitted Charges:**

15.2.1 Neither Party shall create or permit to subsist any encumbrance over all or any of its rights and benefits under this Agreement.

15.2.2 However, the TSP may create any encumbrance over all or part of the receivables, or the Project Assets of the Project in favour of the Lenders or the Lenders' Representative on their behalf, as security for amounts payable under the Financing Agreements and any other amounts agreed by the Parties.

Provided that:

- i. the Lenders or the Lenders' Representative on their behalf shall have entered into the Financing Agreements and agreed in writing to the provisions of this Agreement; and
- ii. any encumbrance granted by the TSP in accordance with this Article 15.2.2 shall contain provisions pursuant to which the Lenders or the Lender's Representative on their behalf agrees unconditionally with the TSP to release from such encumbrances upon payment by the TSP to the Lenders of all amounts due under the Financing Agreements.

15.2.3 Article 15.2.1 does not apply to:

- a. liens arising by operation of law (or by an agreement evidencing the same) in the ordinary course of the TSP developing and operating the Project;
- b. pledges of goods, the related documents of title and / or other related documents, arising or created in the ordinary course of the TSP developing and operating the Project; or
- c. security arising out of retention of title provisions in relation to goods acquired in the ordinary course of the TSP developing and operating the Project.



136

**15.3 Substitution Rights of the Lenders**

15.3.1 The TSP would need to operate and maintain the Project under the provisions of this Agreement and cannot assign the Transmission License or transfer the Project or part thereof to any person by sale, lease, exchange or otherwise, without the prior approval of the Nodal Agency.

15.3.2 However, in the case of default by the TSP in debt repayments or in the case of default by the TSP as per Article 13 of this Agreement during the debt repayments, the Commission may, on an application from the Lenders, assign the Transmission License to the nominee of the Lenders subject to the fulfilment of the qualification requirements and provisions of the Central Electricity Regulatory Commission (Procedure, terms and Conditions for grant of Transmission License and other related matters) Regulations, 2006 and as amended from time to time.

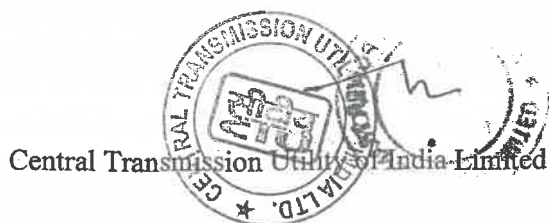

Central Transmission Utility of India Limited

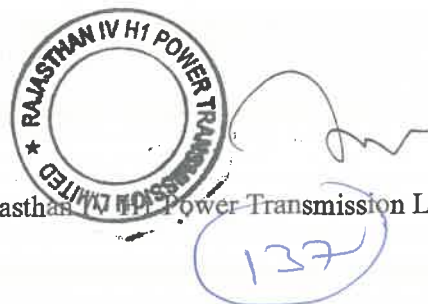

64 Rajasthan Power Transmission Limited

**ARTICLE: 16**

**16 GOVERNING LAW AND DISPUTE RESOLUTION**

**16.1 Governing Law:**

This Agreement shall be governed by and construed in accordance with the Laws of India. Any legal proceedings in respect of any matters, claims or disputes under this Agreement shall be under the jurisdiction of appropriate courts in Delhi.

**16.2 Amicable Settlement:**

16.2.1 Either Party is entitled to raise any claim, dispute or difference of whatever nature arising under, out of or in connection with this Agreement, including its existence or validity or termination or whether during the execution of the Project or after its completion and whether prior to or after the abandonment of the Project or termination or breach of the Agreement by giving a written notice to the other Party, which shall contain:

- (i) a description of the Dispute;
- (ii) the grounds for such Dispute; and
- (iii) all written material in support of its claim.

16.2.2 The other Party shall, within thirty (30) days of issue of notice issued under Article 16.2.1, furnish:

- (i) counter-claim and defences, if any, regarding the Dispute; and
- (ii) all written material in support of its defences and counter-claim.

16.2.3 Within thirty (30) days of issue of notice by the Party pursuant to Article 16.2.1, if the other Party does not furnish any counter claim or defense under Article 16.2.2, or thirty (30) days from the date of furnishing counter claims or defence by the other Party, both the Parties to the Dispute shall meet to settle such Dispute amicably. If the Parties fail to resolve the Dispute amicably within thirty (30) days from the later of the dates mentioned in this Article 16.2.3, the Dispute shall be referred for dispute resolution in accordance with Article 16.3.

**16.3 Dispute Resolution:**

All Disputes shall be adjudicated by the Commission.

**16.4 Parties to Perform Obligations:**

Notwithstanding the existence of any Dispute and difference referred to the Commission as provided in Article 16.3 and save as the Commission may otherwise direct by a final or interim order, the Parties hereto shall continue

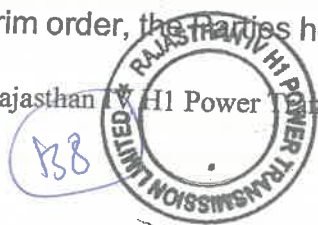



Transmission Service Agreement

to perform their respective obligations/ roles (which are not in dispute) under this Agreement.



139

**ARTICLE: 17**

**17 REPRESENTATION AND WARRANTIES**

**17.1 Representation and warranties of the Nodal Agency**

17.1.1 The Nodal Agency hereby represents and warrants to and agrees with the TSP as follows and acknowledges and confirms that the TSP is relying on such representations and warranties in connection with the transactions described in this Agreement:

- a. It has all requisite powers and authority to execute and consummate this Agreement;
- b. This Agreement is enforceable against the Nodal Agency in accordance with its terms;
- c. The consummation of the transactions contemplated by this Agreement on the part of Nodal Agency will not violate any provision of nor constitute a default under, nor give rise to a power to cancel any charter, mortgage, deed of trust or lien, lease, agreement, license, permit, evidence of indebtedness, restriction, or other contract to which the Nodal Agency is a Party or to which the Nodal Agency is bound, which violation, default or power has not been waived;

**17.2 Representation and Warranties of the TSP:**

17.2.1 The TSP hereby represents and warrants to and agrees with the Nodal Agency as follows and acknowledges and confirms that the Nodal Agency is relying on such representations and warranties in connection with the transactions described in this Agreement:

- a. It has all requisite powers and has been duly authorized to execute and consummate this Agreement;
- b. This Agreement is enforceable against it, in accordance with its terms;
- c. The consummation of the transactions contemplated by this Agreement on the part of the TSP will not violate any provision of nor constitute a default under, nor give rise to a power to cancel any charter, mortgage, deed of trust or lien, lease, agreement, license, permit, evidence of indebtedness, restriction, or other contract to which the TSP is a Party or to which the TSP is bound which violation, default or power has not been waived;
- d. The TSP is not insolvent and no insolvency proceedings have been instituted, nor threatened or pending by or against the TSP;
- e. There are no actions, suits, claims, proceedings or investigations pending or, to the best of the TSP's knowledge, threatened in writing against the TSP at law, in equity, or otherwise, and whether civil or criminal in nature, before or by, any court, commission, arbitrator or

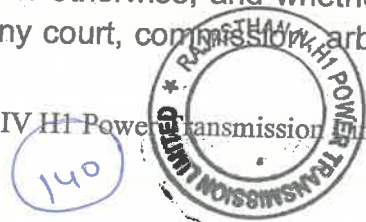
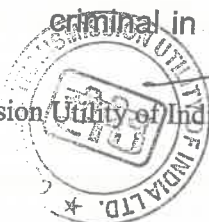

Transmission Service Agreement

governmental agency or authority, and there are no outstanding judgments, decrees or orders of any such courts, commission, arbitrator or governmental agencies or authorities, which materially adversely affect its ability to execute the Project or to comply with its obligations under this Agreement.

17.2.2 The TSP makes all the representations and warranties above to be valid as on the Effective Date of this Agreement.

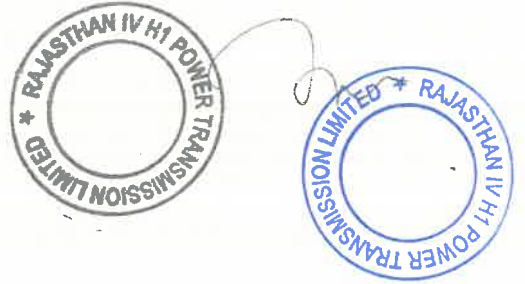

141

## ARTICLE: 18

### 18 INDEPENDENT ENGINEER

#### 18.1 Appointment of Independent Engineer

The Nodal Agency shall appoint an agency/ company as Independent Engineer as per framework provided in the Guidelines for Encouraging Competition in Development of Transmission Projects for selection of Independent Engineer.

#### 18.2 Roles and functions of Independent Engineer

The role and functions of the Independent Engineer shall include the following:

- a. Progress Monitoring as required under this Agreement;
- b. Ensuring Quality as required under this Agreement;
- c. determining, as required under the Agreement, the costs of any works or services and/or their reasonableness during construction phase;
- d. determining, as required under the Agreement, the period or any extension thereof, for performing any duty or obligation during construction phase;
- e. determining, as required under the Agreement, the valuation of the Project Assets.
- f. Assisting the Parties in resolution of Disputes and
- g. Undertaking all other duties and functions in accordance with the Agreement.

#### 18.3 Remuneration of Independent Engineer

The fee and charges of the Independent Engineer shall be paid by the Nodal Agency as per terms & conditions of appointment.

#### 18.4 Termination of appointment

18.4.1 The Nodal Agency may, in its discretion, terminate the appointment of the Independent Engineer at any time, but only after appointment of another Independent Engineer.

18.4.2 If the TSP has reason to believe that the Independent Engineer is not discharging its duties and functions in a fair, efficient and diligent manner, it





may make a written representation to the Nodal Agency and seek termination of the appointment of the Independent Engineer. Upon receipt of such representation, the Nodal Agency shall hold a tripartite meeting with the TSP and Independent Engineer for an amicable resolution, and the decision of Nodal agency is final. In the event that the appointment of the Independent Engineer is terminated hereunder, the Nodal Agency shall appoint forthwith another Independent Engineer.

**18.5 Authorised signatories**

The Nodal Agency shall require the Independent Engineer to designate and notify to the Nodal Agency up to 2 (two) persons employed in its firm to sign for and on behalf of the Independent Engineer, and any communication or document required to be signed by the Independent Engineer shall be valid and effective only if signed by any of the designated persons; provided that the Independent Engineer may, by notice in writing, substitute any of the designated persons by any of its employees.



143

## ARTICLE: 19

### 19 MISCELLANEOUS PROVISIONS

#### 19.1 Equity Lock-in Commitment:

19.1.1 The aggregate equity share holding of the Selected Bidder in the issued and paid up equity share capital of Rajasthan IV H1 Power Transmission Limited shall not be less than Fifty-one percent (51%) up to a period of one (1) year after COD of the Project.

Provided that, in case the Lead Member or Bidding Company is holding equity through Affiliate/s, Ultimate Parent Company or Parent Company, such restriction as specified above shall apply to such entities.

Provided further, that in case the Selected Bidder is a Bidding Consortium, the Lead Member shall continue to hold equity of at least twenty-six percent (26%) up to a period of one (1) year after COD of the Project and any Member of such Bidding Consortium shall be allowed to divest its equity as long as the other remaining Members (which shall always include the Lead Member) hold the minimum equity specified above.

19.1.2 If equity is held by the Affiliates, Parent Company or Ultimate Parent Company of the Selected Bidder, then, subject to the second proviso to Article 19.1.1, such Affiliate, Parent Company or Ultimate Parent Company shall be eligible to transfer its shareholding in Rajasthan IV H1 Power Transmission Limited to another Affiliate or to the Parent Company / Ultimate Parent Company of the Selected Bidder. If any such shareholding entity, qualifying as an Affiliate / Parent Company / Ultimate Parent Company, is likely to cease to meet the criteria to qualify as an Affiliate / Parent Company / Ultimate Parent Company, the shares held by such entity shall be transferred to another Affiliate / Parent Company / Ultimate Parent Company of the Selected Bidder.

19.1.3 Subject to Article 19.1.1, all transfer(s) of shareholding of Rajasthan IV H1 Power Transmission Limited by any of the entities referred to in Article 19.1.1 and 19.1.2 above, shall be after prior written intimation to the Nodal Agency.

19.1.4 For computation of effective Equity holding, the Equity holding of the Selected Bidder or its Ultimate Parent Company in such Affiliate(s) or Parent Company and the equity holding of such Affiliate(s) or Ultimate Parent Company in Rajasthan IV H1 Power Transmission Limited shall be computed in accordance with the example given below:

If the Parent Company or the Ultimate Parent Company of the Selected Bidder

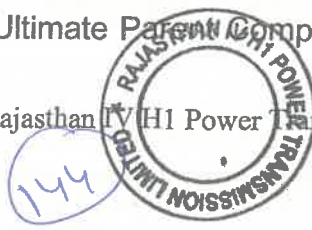
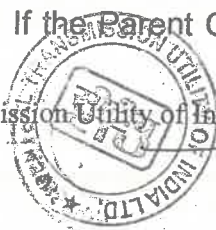

Bidder A directly holds thirty percent (30%) of the equity in Rajasthan IV H1 Power Transmission Limited] then holding of Selected Bidder A in Rajasthan IV H1 Power Transmission Limited shall be thirty percent (30%);

If Selected Bidder A holds thirty percent (30%) equity of the Affiliate and the Affiliate holds fifty percent (50%) equity in Rajasthan IV H1 Power Transmission Limited, then, for the purposes of ascertaining the minimum equity/equity lock-in requirements specified above, the effective holding of Bidder A in Rajasthan IV H1 Power Transmission Limited shall be fifteen percent (15%), (i.e., 30% x 50%)

19.1.5 The provisions as contained in this Article 19.1 shall override the terms of the consortium agreement submitted as part of the Bid.

19.1.6 The TSP shall be responsible to report to Nodal Agency, within thirty (30) days from the occurrence of any event that would result in any change in its equity holding structure from that which existed as on the date of signing of the Share Purchase Agreement. In such cases, the Nodal Agency would reserve the right to ascertain the equity holding structure and to call for all such required documents / information / clarifications as may be required.

## 19.2 Commitment of maintaining Qualification Requirement

19.2.1 The Selected Bidder will be required to continue to maintain compliance with the Qualification Requirements, as stipulated in RFP Document, till the COD of the Project. Where the Technically Evaluated Entity and/or the Financially Evaluated Entity is not the Bidding Company or a Member in a Bidding Consortium, as the case may be, the Bidding Company or Member shall continue to be an Affiliate of the Technically Evaluated Entity and/or Financially Evaluated Entity till the COD of the Project.

19.2.2 Failure to comply with the aforesaid provisions shall be dealt in the same manner as TSP's Event of Default as under Article 13 of this Agreement.

## 19.3 Language:

19.3.1 All agreements, correspondence and communications between the Parties relating to this Agreement and all other documentation to be prepared and supplied under the Agreement shall be written in English; and the Agreement shall be construed and interpreted in accordance with English language.

19.3.2 If any of the agreements, correspondence, communications or documents are prepared in any language other than English, the English translation



of such agreements, correspondence, communications or documents shall prevail in matters of interpretation.

**19.4 Affirmation**

The TSP and the Nodal Agency, each affirm that:

1. neither it nor its respective directors, employees, or agents has paid or undertaken to pay or shall in the future pay any unlawful commission, bribe, pay-off or kick-back; and
2. it has not in any other manner paid any sums, whether in Indian currency or foreign currency and whether in India or abroad to the other Party to procure this Agreement, and the TSP and the Nodal Agency hereby undertake not to engage in any similar acts during the Term of Agreement.

**19.5 Severability**

The invalidity or enforceability, for any reason, of any part of this Agreement shall not prejudice or affect the validity or enforceability of the remainder of this Agreement, unless the part held invalid or unenforceable is fundamental to this Agreement.

**19.6 Counterparts**

This Agreement may be executed in one or more counterparts, each of which shall be deemed an original and all of which collectively shall be deemed one and the same Agreement.

**19.7 Breach of Obligations/ Roles**

The Parties acknowledge that a breach of any of the obligations/ roles contained herein would result in injuries. The Parties further acknowledge that the amount of the liquidated damages or the method of calculating the liquidated damages specified in this Agreement is a genuine and reasonable pre-estimate of the damages that may be suffered by the non-defaulting Party in each case specified under this Agreement.

**19.8 Restriction of Shareholders / Owners Liability**

19.8.1 Parties expressly agree and acknowledge that none of the shareholders of the Parties hereto shall be liable to the other Parties for any of the contractual obligations of the concerned Party under this Agreement.

19.8.2 Further, the financial liabilities of the shareholder(s) of each Party to this Agreement shall be restricted to the extent provided in the Indian Companies Act, 1956 / Companies Act, 2013 (as the case may be).

**19.9 Taxes and Duties:**

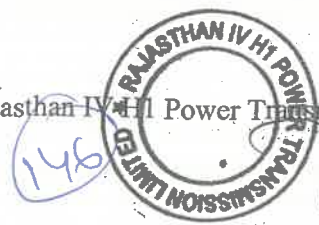



- 19.9.1 The TSP shall bear and promptly pay all statutory taxes, duties, levies and cess, assessed/levied on the TSP, its Contractors or their employees that are required to be paid by the TSP as per the Law in relation to the execution of the Project and for providing Transmission Service as per the terms of this Agreement.
- 19.9.2 The Nodal Agency shall be indemnified and held harmless by the TSP against any claims that may be made against the Nodal Agency in relation to the matters set out in Article 19.9.1.
- 19.9.3 The Nodal Agency shall not be liable for any payment of, taxes, duties, levies, cess whatsoever for discharging any obligation of the TSP by the Nodal Agency on behalf of TSP or its personnel, provided the TSP has consented in writing to the Nodal Agency for such work, for which consent shall not be unreasonably withheld.

**19.10 No Consequential or Indirect Losses**

The liability of the TSP shall be limited to that explicitly provided in this Agreement.

Provided that, notwithstanding anything contained in this Agreement, under no event shall the Nodal Agency or the TSP claim from one another any indirect or consequential losses or damages.

**19.11 Discretion:**

Except where this Agreement expressly requires a Party to act fairly or reasonably, a Party may exercise any discretion given to it under this Agreement in any way it deems fit.

**19.12 Confidentiality**

19.12.1 The Parties undertake to hold in confidence this Agreement and RFP Project Documents and not to disclose the terms and conditions of the transaction contemplated hereby to third parties, except:

- (a) to their professional advisors;
- (b) to their officers, contractors, employees, agents or representatives, financiers, who need to have access to such information for the proper performance of their activities; or
- (c) disclosures required under Law, without the prior written consent of the other Parties.

Provided that, the TSP agrees and acknowledges that the Nodal Agency, may at any time, disclose the terms and conditions of the Agreement and

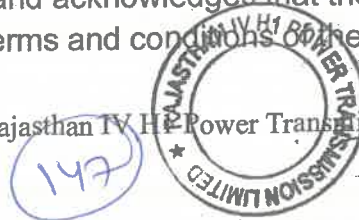
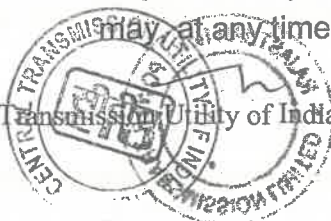

the RFP Project Documents to any person, to the extent stipulated under the Law and the Competitive Bidding Guidelines.

**19.13 Order of priority in application:**

Save as provided in Article 2.5, in case of inconsistencies between the terms and conditions stipulated in Transmission License issued by the Commission to the TSP, agreement(s) executed between the Parties, applicable Law including rules and regulations framed thereunder, the order of priority as between them shall be the order in which they are placed below:

- terms and conditions of Transmission License;
- applicable Law, rules and regulations framed thereunder;
- this Agreement;
- Agreement(s), if any, under Sharing Regulations.

**19.14 Independent Entity:**

19.14.1 The TSP shall be an independent entity performing its obligations pursuant to the Agreement.

19.14.2 Subject to the provisions of the Agreement, the TSP shall be solely responsible for the manner in which its obligations under this Agreement are to be performed. All employees and representatives of the TSP or Contractors engaged by the TSP in connection with the performance of the Agreement shall be under the complete control of the TSP and shall not be deemed to be employees, representatives, Contractors of the Nodal Agency and nothing contained in the Agreement or in any agreement or contract awarded by the TSP shall be construed to create any contractual relationship between any such employees, representatives or Contractors and the Nodal Agency.

**19.15 Amendments:**

19.15.1 This Agreement may only be amended or supplemented by a written agreement between the Parties.

**19.16 Waiver:**

19.16.1 No waiver by either Party of any default or breach by the other Party in the performance of any of the provisions of this Agreement shall be effective unless in writing duly executed by an authorized representative of such Party.

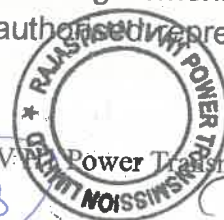

19.16.2 Neither the failure by either Party to insist on any occasion upon the performance of the terms, conditions and provisions of this Agreement nor time or other indulgence granted by one Party to the other Parties shall act as a waiver of such breach or acceptance of any variation or the relinquishment of any such right or any other right under this Agreement, which shall remain in full force and effect.

**19.17 Relationship of the Parties:**

This Agreement shall not be interpreted or construed to create an association, joint venture, or partnership or agency or any such other relationship between the Parties or to impose any partnership obligation or liability upon either Party and neither Party shall have any right, power or authority to enter into any agreement or undertaking for, or act on behalf of, or to act as or be an agent or representative of, or to otherwise bind, the other Party.

**19.18 Entirety:**

19.18.1 This Agreement along with its sections, schedules and appendices is intended by the Parties as the final expression of their agreement and is intended also as a complete and exclusive statement of the terms of their agreement.

19.18.2 Except as provided in this Agreement, all prior written or oral understandings, offers or other communications of every kind pertaining to this Agreement or the provision of Transmission Service under this Agreement to the Nodal Agency by the TSP shall stand superseded and abrogated.

**19.19 Notices:**

19.19.1 All notices or other communications which are required to be given under this Agreement shall be in writing and in the English language

19.19.2 If to the TSP, all notices or communications must be delivered personally or by registered post or facsimile or any other mode duly acknowledged to the addressee below:

	<i>Cor. Address</i>	<i>Bus Address</i>
Address	: Plot No. 2, Saudamini, Sector-29 Gurgaon - 122001	: Plot No. 54, Samasavl Road, Vadodare, Gujarat - 290024
Attention	: ED (TBCB)	Sh. R. K. Gupta
Email	: tbeb@powergrid.in	
Fax No.	:	
Telephone No.	: 0124-2822095 99103 78037	rajendra 2499@powergrid.in 95608 90039

19.19.3 If to the Nodal Agency, all notices or communications must be delivered personally or by registered post or facsimile or any other mode duly

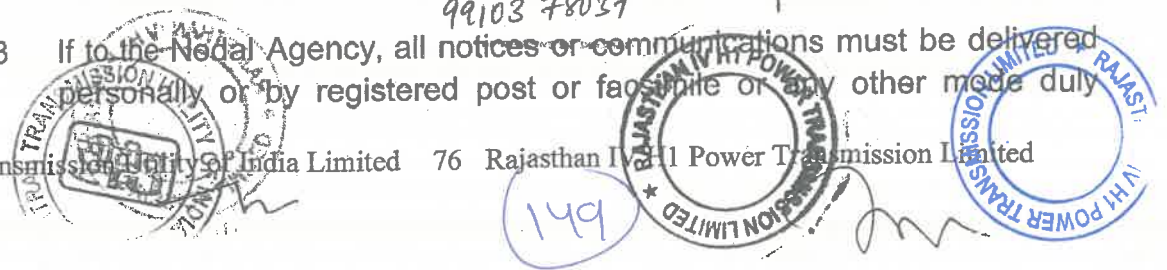

acknowledged to the addresses below:

(i) **CENTRAL TRANSMISSION UTILITY OF INDIA LIMITED**

Address : Plot No.2, Sector – 29, Gurugram, Haryana-  
122001, India  
Attention : Mr. Atul Kumar Agarwal, CGM  
Email : atul\_ag@powergrid.in  
Fax. No. :  
Telephone No. : 9910378059

19.19.4 All notices or communications given by facsimile shall be confirmed by sending a copy of the same via post office in an envelope properly addressed to the appropriate Party for delivery by registered mail. All notices shall be deemed validly delivered upon receipt evidenced by an acknowledgement of the recipient, unless the Party delivering the notice can prove in case of delivery through the registered post that the recipient refused to acknowledge the receipt of the notice despite efforts of the postal authorities.

19.19.5 Any Party may by notice of at least fifteen (15) days to the other Party change the address and/or addresses to which such notices and communications to it are to be delivered or mailed.

**19.20 Fraudulent and Corrupt Practices**

19.20.1 The TSP and its respective officers, employees, agents and advisers shall observe the highest standard of ethics during the subsistence of this Agreement. Notwithstanding anything to the contrary contained in the Agreement, the Nodal Agency may terminate the Agreement without being liable in any manner whatsoever to the TSP, if it determines that the TSP has, directly or indirectly or through an agent, engaged in corrupt practice, fraudulent practice, coercive practice, undesirable practice or restrictive practice in the Bid process. In such an event, the Nodal Agency shall forfeit the Contract Performance Guarantee of the TSP, without prejudice to any other right or remedy that may be available to the Nodal Agency hereunder or subsistence otherwise.

19.20.2 Without prejudice to the rights of the Nodal Agency under Clause 19.20.1 hereinabove and the rights and remedies which the Nodal Agency may have under this Agreement, if a TSP is found by the Nodal Agency to have directly or indirectly or through an agent, engaged or indulged in any corrupt practice, fraudulent practice, coercive practice, undesirable practice or restrictive practice during the Bid process, or after the issue of Letter of Intent (hereinafter referred to as LoI) or after the execution of the agreement(s) required under Sharing Regulations, the Nodal Agency may terminate the Agreement without being liable in any manner whatsoever

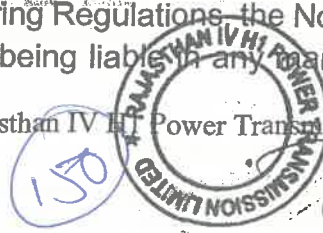
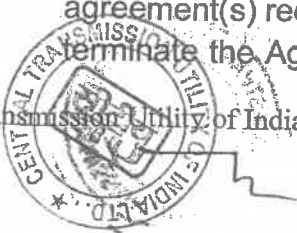



to the TSP. Further, the TSP & its Affiliates shall not be eligible to participate in any tender or RFP issued by any BPC for an indefinite period from the date such TSP is found by the Nodal Agency to have directly or indirectly or through an agent, engaged or indulged in any corrupt practice, fraudulent practice, coercive practice, undesirable practice or restrictive practices, as the case may be.

19.20.3 For the purposes of this Clause 19.20, the following terms shall have the meaning hereinafter respectively assigned to them:

(a) **“corrupt practice”** means (i) the offering, giving, receiving, or soliciting, directly or indirectly, of anything of value to influence the actions of any person connected with the Bid process (for avoidance of doubt, offering of employment to or employing or engaging in any manner whatsoever, directly or indirectly, any official of the BPC who is or has been associated or dealt in any manner, directly or indirectly with the Bid process or the Lol or has dealt with matters concerning the RFP Project Documents or arising there from, before or after the execution thereof, at any time prior to the expiry of one year from the date such official resigns or retires from or otherwise ceases to be in the service of the BPC, shall be deemed to constitute influencing the actions of a person connected with the Bid Process); or (ii) engaging in any manner whatsoever, whether during the Bid Process or after the issue of the Lol or after the execution of the RFP Project Documents, as the case may be, any person in respect of any matter relating to the Project or the Lol or the RFP Project Documents, who at any time has been or is a legal, financial or technical adviser of the BPC in relation to any matter concerning the Project;

(b) **“fraudulent practice”** means a misrepresentation or omission of facts or suppression of facts or disclosure of incomplete facts, in order to influence the Bid process;

(c) **“coercive practice”** means impairing or harming, or threatening to impair or harm, directly or indirectly, any person or property to influence any person’s participation or action in the Bid process;

(d) **“undesirable practice”** means (i) establishing contact with any person connected with or employed or engaged by the BPC with the objective of canvassing, lobbying or in any manner influencing or attempting to influence the Bid process; or (ii) having a Conflict of Interest; and

(e) **“restrictive practice”** means forming a cartel or arriving at any understanding or arrangement among Bidders with the objective of restricting or manipulating a full and fair competition in the Bid process;

#### 19.21 Compliance with Law:

Despite anything contained in this Agreement but without prejudice to Article 12, if any provision of this Agreement shall be in deviation or inconsistent with or repugnant to the provisions contained in the Electricity

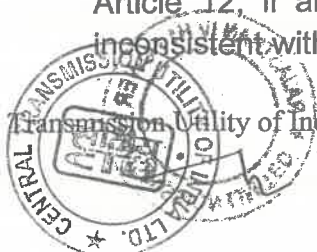

157

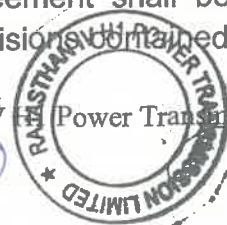

Transmission Service Agreement

Act, 2003, or any rules and regulations made there under, such provision shall be deemed to be amended to the extent required to bring it into compliance with the aforesaid relevant provisions as amended from time to time.

IN WITNESS WHEREOF, THE PARTIES HAVE CAUSED THIS AGREEMENT TO BE EXECUTED BY THEIR DULY AUTHORISED REPRESENTATIVES AS OF THE DATE AND PLACE SET FORTH ABOVE.

1. For and on behalf of TSP   
.....RAJENDRA KUMAR GUPTA  
[Signature, Name, Designation and Address]  
GM, JABALPUR,

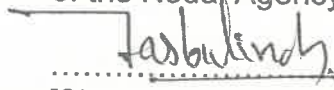
2. For and on behalf of .....[Insert name of the Nodal Agency]  
  
.....JASBIR SINGH  
[Signature, Name, Designation and Address]

**JASBIR SINGH**  
Executive Director  
CENTRAL TRANSMISSION UTILITY OF INDIA LTD.  
(A Wholly Owned Subsidiary of  
Power Grid Corporation of India Ltd)  
(A Government of India Enterprises)  
Plot No.-2, Sector-29, Gurgaon- 122 001 (Haryana)

**WITNESSES:**

1. For and on behalf of  
: BPC

  
.....  
[Signature]

(SATYABAN SAHOO), GM, REC PDEL

.....  
[Insert, Name, Designation and Address of the Witness]

2. For and on behalf of  
: Nodal Agency

  
.....  
[Signature]

KAMAL KUMAR JAIN, Sr GM, CTUIL

.....  
[Insert Name, Designation and Address of the Witness]

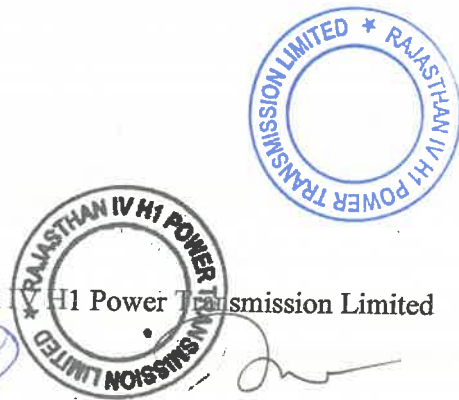
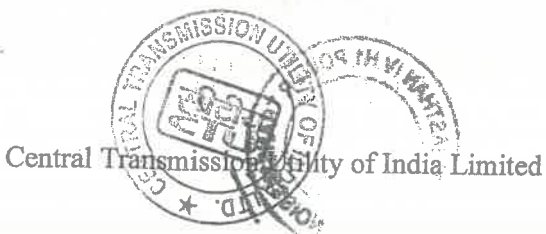

# SCHEDULES

Central Transmission Utilities of India Limited



80

Rajasthan HV HT Power Transmission Limited

153



## Schedule: 1

## Project Description and Scope of Project

## Scope of the Project:

Si. No.	Scope of the Transmission Scheme	Scheduled COD in months from Effective Date
1.	<p>Establishment of 765/400 kV (2x1500 MVA), 400/220 kV (2x500 MVA) &amp; 220/132 kV (3x200 MVA) Kurawar S/s with 2x330 MVAR 765 kV bus reactor and 1x125 MVAR, 420 kV bus reactor.</p> <ul style="list-style-type: none"> <li>• 765/400 kV, 1500 MVA ICT – 2 (7 single units of 500 MVA including one spare unit)</li> <li>• 400/220 kV, 500 MVA ICT – 2</li> <li>• 220/132 kV, 200 MVA ICT – 3</li> <li>• 765 kV ICT bays- 2</li> <li>• 400 kV ICT bays- 4</li> <li>• 220 kV ICT bays – 5</li> <li>• 132 kV ICT bays - 3</li> <li>• 330 MVAR 765 kV bus reactor-2</li> <li>• 125 MVAR 420 kV bus reactor-1</li> <li>• 765 kV reactor bay- 2</li> <li>• 765 kV line bays- 4</li> <li>• 400 kV line bays- 4</li> <li>• 400 kV reactor bay- 1</li> <li>• 220 kV BC – 1</li> <li>• 220 kV TBC – 1</li> <li>• 132 kV TBC – 1</li> <li>• 110 MVAR, 765 kV, 1-ph reactor (spare unit)-1</li> <li>• 80 MVAR, 765 kV, 1-ph reactor (spare unit)-1</li> </ul> <p><b>Future Provisions:</b></p> <p>Space for</p> <ul style="list-style-type: none"> <li>• 765/400 kV ICT along with bays- 4 no.</li> <li>• 765 kV line bays along with switchable line reactors – 8 nos.</li> <li>• 765 kV Bus Reactor along with bay: 2 no.</li> <li>• 765 kV Sectionalizer bay: 1 -set</li> <li>• 400 kV line bays along with switchable line reactor – 8 nos.</li> <li>• 400/220 kV ICT along with bays -6 nos.</li> <li>• 420 kV Bus Reactor along with bay: 3no.</li> <li>• 400 kV Sectionalization bay: 1- set</li> <li>• 220 kV line bays: 12 nos.</li> <li>• 220 kV Sectionalization bay: 1set</li> </ul>	24 months (15/10/2026 )

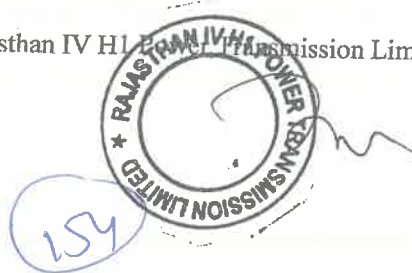



Sl. No.	Scope of the Transmission Scheme	Scheduled COD in months from Effective Date
	<ul style="list-style-type: none"> <li>• 220 kV BC and TBC: 1 no.</li> <li>• 220/132 kV ICT along with bays: 5 Nos.</li> <li>• 132 kV line bays: 16 nos.</li> <li>• 132 kV Sectionalization bay: 1 set</li> <li>• 132 kV TBC- 1 no.</li> <li>• STATCOM (<math>\pm 300</math> MVAR) along with MSC (2x125 MVAR) &amp; MSR (1x125 MVAR) along with 400 kV bay.</li> </ul>	
2.	Mandsaur – Kurawar 765 kV D/c line	
3.	240 MVAR switchable line reactors on each ckt at both ends of Mandsaur – Kurawar 765 kV D/c line <ul style="list-style-type: none"> <li>• 240 MVAR, 765 kV switchable line reactor- 4 (2 for Mandsaur end and 2 for Kurawar end)</li> <li>• Switching equipment for 765 kV line reactor- 4 (2 for Mandsaur end and 2 for Kurawar end)</li> <li>• 80 MVAR, 765 kV, 1-ph reactor (spare unit)-1 No. for Mandsaur end</li> </ul>	
4.	2 nos. of 765 kV line bays at Mandsaur S/s for termination of Mandsaur – Kurawar 765 kV D/c line <ul style="list-style-type: none"> <li>• 765 kV line bays – 2 Nos. (for Mandsaur end)</li> </ul>	
5.	LILO of Indore – Bhopal 765 kV S/c line at Kurawar	
6.	Kurawar – Ashta 400 kV D/c (Quad ACSR/AAAC/AL59 moose equivalent) line	
7.	2 nos. of 400 kV line bays at Ashta (MP) S/s for termination of Kurawar – Ashta 400 kV D/c line <ul style="list-style-type: none"> <li>• 400 kV line bays – 2 Nos. [for Ashta (MP) end]</li> </ul>	
8.	LILO of one circuit of Indore – Itarsi 400 kV D/c line at Ashta	
9.	2 nos. of 400 kV line bays at Ashta (MP) S/s for LILo of one circuit of Indore – Itarsi 400 kV D/c line at Ashta <ul style="list-style-type: none"> <li>• 400 kV line bays – 2 Nos. [for Ashta (MP) end]</li> </ul>	
10.	Shujalpur – Kurawar 400 kV D/c (Quad ACSR/AAAC/AL59 moose equivalent) line	
11.	2 nos. of 400 kV line bays at Shujalpur(PG) S/s for termination of Shujalpur – Kurawar 400 kV D/c line <ul style="list-style-type: none"> <li>• 400 kV line bays – 2 Nos. [for Shujalpur (PG) end]</li> </ul>	

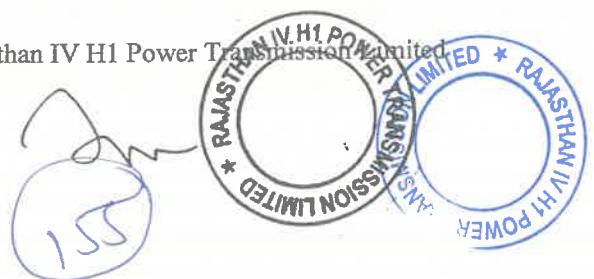
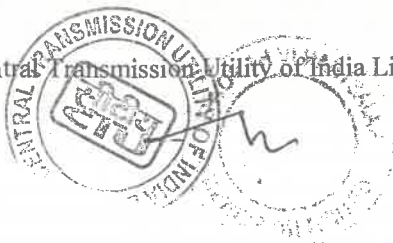

**Note:**

- a) *MPPTCL has confirmed availability of space for 2 nos. 400 kV bays at Ashta (MP) S/s and for 2 nos. additional bays, MPPTCL has informed that adjacent land is private land and may be purchased by the project developer at their cost as per requirement.*
- b) *Implementation of A, B, C, D, E, F, H1 and H2 packages shall be aligned.*
- c) *TSP of the subject scheme shall implement Inter-tripping scheme on Mandsaur – Kurawar 765 kV D/c line (for tripping of the switchable line reactor at Mandsaur/Kurawar end along with the main line breaker).*
- d) *Switchable line reactors shall be implemented with NGR bypass arrangement.*
- e) *Developer of Mandsaur S/s shall provide space for 2 Nos. 765 kV line bays for Mandsaur - Kurawar 765 kV D/c line along with space for 2 nos. of 240 MVAR switchable line reactor and space for spare 80 MVAR single phase reactor unit.*
- f) *POWERGRID shall provide space for 2 Nos. 400 kV line bays at Shujalpur S/s for Shujalpur – Kurawar 400 kV D/c line*
- g) *Implementation timeframe: 24 months from date of SPV acquisition.\**

**Project Description:**

Renewable Energy Zones (REZs) were identified by MNRE/SECI with a total capacity of 181.5 GW for likely benefits by the year 2030 in eight states. This includes 75 GW REZ potential in Rajasthan comprising of 15 GW Wind and 60 GW Solar. In this regard, a Comprehensive transmission scheme for evacuation of 75GW RE potential (45GW evacuation capacity) from Rajasthan is already evolved, which includes transmission scheme for total evacuation requirement of 5.5 GW (Ph-IV: Part-2:) from Jaisalmer/Barmer Complex (Fatehgarh -IV: 4 GW, Barmer-I: 1.5 GW).

As part of comprehensive system, 765/400/220kV Fatehgarh-IV (Sec-2) and 765/400/220kV Barmer-I PS are to be established for RE injection. For evacuation of power from above pooling stations, 765/400kV Sirohi and Rishabdeo S/s are to be established along with interconnections through 765kV lines i.e. 765kV Fatehgarh-IV-Sirohi & Barmer-I PS – Sirohi, LILO of both ckts of 765 kV Fatehgarh III- Beawar D/c line at Fatehgarh-IV (Sec-2) PS and 765kV Sirohi PS- Rishabdeo as well as 400kV interconnections i.e. Fatehgarh-IV (Sec-2) PS – Bhinmal (PG).

For further dispersal of power towards load centers, 765kV high capacity corridor i.e. Rishabdeo - Mandsaur (WR), Beawar - Mandsaur (WR), LILo of one circuit of 765 kV Chittorgarh - Banaskanta D/c line at Rishabdeo as well as 400kV interconnections i.e. Sirohi PS-Chittorgarh (PG) is also being implemented. Further 765/400/220kV Mandsaur and 765/400/220/132kV Kurawar S/s and associated transmission schemes in Western region are also being implemented as part of comprehensive scheme. The scheme shall also cater to evacuation of power from Neemuch/Mandsaur 2GW WEZ under 181.5GW potential in WR.

The subject transmission scheme i.e. Transmission system for evacuation of power from Rajasthan REZ Ph-IV (Part-2: 5.5 GW) (Jaisalmer/Barmer Complex): Part H1 involves Establishment of 765/400kV (2x1500 MVA), 400/220 kV (2x500 MVA) and 220/132 kV (3x200 MVA) Kurawar S/s alongwith Mandsaur – Kurawar 765 kV D/c line, LILo of Indore – Bhopal 765 kV S/c line at Kurawar, Kurawar – Ashta 400 kV

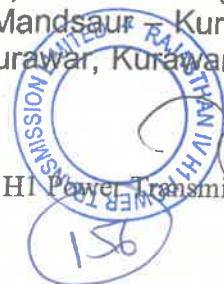

Transmission Service Agreement

D/c line, LILLO of one circuit of Indore – Itarsi 400 kV D/c line at Ashta and Shujalpur – Kurawar 400 kV D/c line.

The subject Transmission system was deliberated and approved in the 14th NCT meeting held on 09.06.2023. The Ministry of Power vide Gazette notification dated 4.09.2023 (Copy of Gazette attached) has appointed PFCCL as BPC for implementation of the subject transmission scheme through TBCB route. The scope of the transmission scheme was modified for inclusion of spare 80 MVAR reactor in the 15th meeting of NCT held on 25.08.2023.

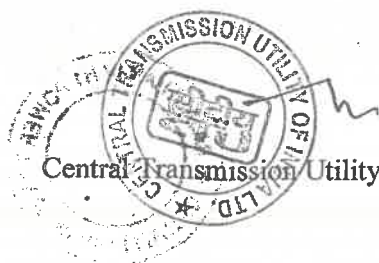
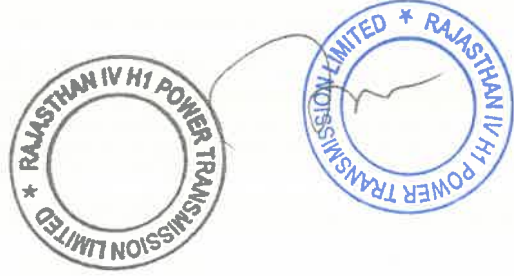

157

**SPECIFIC TECHNICAL REQUIREMENTS FOR TRANSMISSION LINE**

The design, routing and construction of transmission lines shall be in accordance with Chapter V, Part A of CEA (Technical Standards for Construction of Electrical Plants and Electric Lines) Regulations 2022, as amended from time to time. Other CEA Regulations and MoP guidelines, as applicable, shall also be followed.

- A.1.0 Selection of tower type shall be made as per CEA Regulations, however in case lattice type towers are used, the following shall also be applicable:
- A.2.0 Steel section of grade E 250 and/or grade E 350 as per IS 2062, only are permitted for use in towers, extensions, gantry structures and stub setting templates. For towers in snowbound areas, steel sections shall conform to Grade-C of IS-2062.
- A.3.0 Towers shall be designed as per IS-802:2015, however the drag coefficient of the tower shall be as follows: -

Solidity Ratio	Drag Coefficient
Upto 0.05	3.6
0.1	3.4
0.2	2.9
0.3	2.5
0.4	2.2
0.5 and above	2.0

- A.4.0 Transmission Service Provider (TSP) shall adopt any additional loading/design criteria for ensuring reliability of the line, if so desired and /or deemed necessary.
- A.5.0 Transmission line shall be designed considering wind zones as specified in wind map given in National Building Code 2016, Vol.1. The developer shall also make his own assessment of local wind conditions and frequent occurrences of high intensity winds (HIW) due to thunderstorms, dust-storms, downburst etc. along the line route and wherever required, higher wind zone than that given in wind map shall be considered for tower design for ensuring reliability of line. Further, for transmission line sections passing within a distance of 50 km from the boundary of two wind zones, higher of the two wind zones shall be considered for design of towers located in such sections.
- A.6.0 Selection of reliability level for design of tower shall be as per CEA Regulation (Technical Standards for Construction of Electrical Plants and Electric Lines) Regulations 2022, as amended from time to time.
- A.7.0 A) For power line crossing of 400 kV or above voltage level, large angle & dead end towers (i.e. D/DD/QD) shall be used on either side of power line crossing.  
B) For power line crossing of 132 kV and 220 kV voltage level, angle towers (B/C/D/DB/DC/DD/ QB/QC/QD) shall be used on either side of power line crossing.

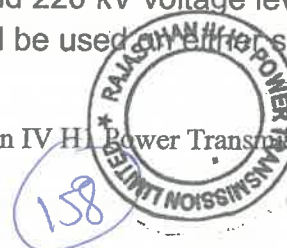



crossing depending upon the merit of the prevailing site condition and line deviation requirement.

- C) For power line crossing of 66 kV and below voltage level, suspension/tension towers shall be provided on either side of power line crossing depending upon the merit of the prevailing site condition and line deviation requirement.
- D) For crossing of railway tracks, national highways and state highways, the rules/ regulations of appropriate authorities shall be followed.

A.8.0 The relevant conductor configuration for 765kV shall be as follows: -

Transmission line	ACSR Conductor specified	Equivalent AAAC conductor based on 53.5% conductivity of Al Alloy	Equivalent minimum size of AL59 conductor based on 59% conductivity of AL Alloy*	Sub-conductor Spacing
765kV D/C (Hexa Zebra) transmission lines	Zebra: Stranding 54/3.18 mm-Al + 7/3.18 mm- Steel, 428 sq mm, Aluminium area,  28.62 mm diameter  Maximum DC Resistance at 20°C (Ω/km): 0.06868 Minimum UTS: 130.32 kN	Stranding details: 61/3.19mm,  487.5 sq.mm Aluminium alloy area 28.71 mm diameter  Maximum DC Resistance at 20°C (Ω/km): 0.06815 Minimum UTS: 135.6 kN	Stranding details: 61/3.08mm,  454 sq.mm Aluminium alloy area 27.72 mm diameter  Maximum DC Resistance at 20°C (Ω/km): 0.0653 Minimum UTS: 108 kN	457 mm



159

The relevant conductor configuration for 400kV shall be as follows: -

Transmission line	ACSR Conductor specified	Equivalent AAAC conductor based on 53% conductivity of Al Alloy	Equivalent minimum size of AL59 conductor based on 59% conductivity of AL Alloy*	Sub-conductor Spacing
400 kV D/C (Quad Moose) transmission lines	<b>Moose:</b> <b>Stranding</b> 54/3.53mm-Al + 7/3.53 mm-Steel, 31.77 mm diameter 528.5 sq. mm, Aluminium area, Maximum DC Resistance at 20°C (Ω/km): 0.05552 Minimum UTS: 161.20 kN	<b>Stranding details:</b> 61/3.55mm 31.95mm diameter; 604 sq. mm Aluminium alloy area Maximum DC Resistance at 20°C (Ω/km): 0.05506 Minimum UTS: 159.80 kN	<b>Stranding details:</b> 61/3.31mm 29.79 mm diameter; 525 sq. mm Aluminium alloy area Maximum DC Resistance at 20°C (Ω/km): 0.0566 Minimum UTS: 124.70 kN	450 mm

**Note:**

1. \*To Select any size above the minimum, the sizes mentioned in the Indian standard IS-398(part-6) shall be followed.
2. The transmission lines shall have to be designed for a maximum operating conductor temperature of 85 deg C.

A.9.0 The required phase to phase spacing and horizontal spacing for 765kV and 400kV line shall be governed by the tower design as well as minimum live metal clearances for 765kV and 400kV voltage level under different insulator swing angles. However, the phase to phase spacing for 765kV line shall not be less than 15 m and for 400kV line shall not be less than 8 m.

A.10.0 Electrical clearances including minimum live metal clearance, ground clearance and minimum mid span separation between earth wire and conductor as given below shall be considered:

**I. Minimum live metal clearances for 765 kV line:**

**(i) Under stationary conditions**

From tower body: For 765 kV D/C: 6.1 m  
 For 765 kV S/C: 5.6 m

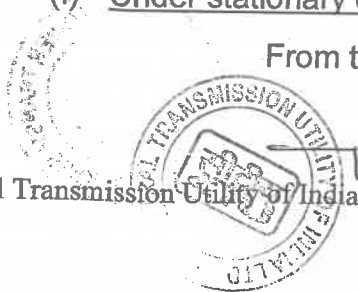

160



(ii) Under swing conditions

Wind pressure Condition	Minimum electrical clearance
a) Swing angle (25°)	4.4 m
b) Swing angle (55°)	1.3 m

(iii) Minimum ground clearance: 18 m

(iv) Minimum mid span separation between earth-wire and conductor: 9.0 m

**II. Minimum live metal clearances for 400 kV line:**

(i) Under stationary conditions

From tower body: 3.05 m

(ii) Under swing conditions

Wind pressure Condition	Minimum electrical clearance
a) Swing angle (22°)	3.05 m
b) Swing angle (44°)	1.86 m

(iii) Minimum ground clearance: 8.84 m

(iv) Minimum mid span separation between earth-wire and conductor: 9.0 m

A.11.0 Shielding angle shall not exceed 10 deg for 765kV D/C Line transmission line and 20 deg for 400kV D/C Line transmission line.

A.12.0 The Fault current for design of line shall be 50kA for 1 sec for 765kV and 63kA for 1 sec for 400kV.

A.13.0 In case of 400kV and above voltage class lines, at least one out of two earth wires shall be OPGW and second earth wire, if not OPGW, shall be either of galvanized standard steel (GSS) or Aluminium Alloy Conductor Steel Reinforced (AACSR) conductor type or any other suitable conductor type depending upon span length and other technical consideration.

A.14.0 Each tower shall be earthed such that tower footing impedance does not exceed 10 ohms. Pipe type or Counterpoise type earthing shall be provided in accordance with relevant IS. Additional earthing shall be provided on every 7 to 8 kms distance for direct earthing of both shield wires. If site condition demands, multiple earthing or use of earthing enhancement compound shall be used.

A.15.0 Pile type foundation shall be used for towers located in river or creek bed or on bank of river having scourable strata or in areas where river flow or change in river course is anticipated, based on detailed soil investigation and previous years' maximum flood discharge of the river, maximum velocity of water, highest flood level, scour depth and anticipated change in course of river based on river morphology data of at least past 20 years to ensure availability and reliability of the transmission line.

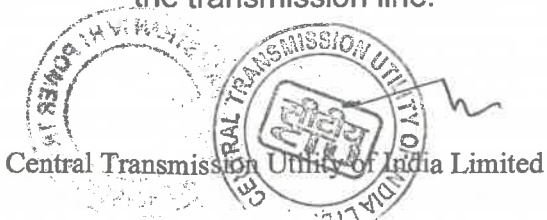

- A.16.0 Transmission line route shall be finalized, in consultation with appropriate authorities so as to avoid the habitant zones of endangered species and other protected species. Bird diverters, wherever required, shall be provided on the line.
- A.17.0 Wherever, transmission lines are passing through cyclone prone areas i.e. areas upto 60 km from coast following shall also be applicable:
- Terrain category-I, with terrain roughness factor (K2) of 1.08 shall be considered for tower design for exposed open terrain with few or no obstruction which also includes open sea coasts, open stretch of water, desert and flat treeless plains
  - Importance factor for cyclonic region (K4) of 1.3 shall be considered for tower design.
  - The number of consecutive spans between the section points/ angle point shall not exceed 10 spans or 3km instead of conventional practice of 15 spans or 5km, in order to reduce the failure of such towers in coastal areas due to cascading effect. The section shall be terminated with tension tower/ angle tower and angle of deviation should be based on the site requirement.
- A.18.0 Wherever, transmission lines are passing through cyclone prone areas (i.e. areas upto 60 km from coast)/ creek regions/ aggressive soil areas following shall also be applicable:
- The fabricated tower parts and stubs shall have a minimum overall zinc coating of 900 g/m<sup>2</sup> of surface area except for plates and sections below 5mm which shall have a minimum overall zinc coating of 610 g/m<sup>2</sup> of surface area. The average zinc coating for all sections and plates 5mm and above shall be maintained as 127 microns and that for plates and sections below 5mm shall be maintained as 87 microns.
  - Ready mix concrete of M30 Grade shall be used to avoid use of locally available saline water. However, design mix concrete of M30 Grade conforming to IS-456 with potable water can be used at locations where transportation of ready-mix concrete is not feasible. Minimum cement content in any case shall not be less than 330kg/m<sup>3</sup>.
  - The surface of the reinforced steel shall be treated with epoxy-based coating to enhance corrosion performance of foundation. Use of epoxy coated reinforcement in foundation shall be as per IS 13620. In addition, two (2) coats of bituminous painting of minimum 1.6kg/ m<sup>2</sup> per coat shall be applied on all exposed faces of foundation (i.e. pedestal and base slab).
  - Double coat 20mm thick cement plaster shall be provided on all exposed concrete surface as well up to 300mm below ground level to give

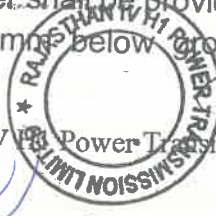



protection to concrete surface from environmental and saline effect.

- e) Before coping of chimney top portion, three coats of anti-corrosive paint of minimum 30-35 microns dry film thickness each shall be applied on the stub in the 50mm coping portion as well as up to 350mm above CL portion.

- A.19.0 The raised chimney foundation is to be provided in areas prone to flooding/water stagnation like paddy field /agricultural field and undulated areas to avoid direct contact of water with steel part of tower. The top of the chimney of foundation should be at least above HFL (High Flood Level) or the historical water stagnation/ logging level (based on locally available data) or above High Tide Level or 500 mm above Natural Ground level (whichever is higher).
- A.20.0 Routing of transmission line through protected areas of India shall be avoided to the extent possible. In case, it is not possible to avoid protected areas, the towers of the transmission line upto 400 kV level which are installed in protected areas shall be designed for Multi-circuit (4 circuits) configuration of same voltage level considering reliability level of at least two (2). The top two circuits of these multi-circuit towers shall be used for stringing of the transmission line under present scope and the bottom two circuits shall be made available for stringing of any future transmission line of any transmission service providers/ State transmission utilities/Central transmission utilities passing through the same protected area. Further, the configuration and coordinates of such transmission towers shall be submitted to CEA, CTU and BPC by the TSP.
- A.21.0 The TSP shall abide by the Guidelines of CEA w.r.t. shifting of transmission lines for NHAI projects and other projects.
- A.22.0 Safety precautions in regards to gas/oil pipe lines in vicinity of Transmission lines shall be taken in coordination with gas/ petroleum authorities.



**SPECIFIC TECHNICAL REQUIREMENTS FOR SUBSTATION**

The proposed Kurawar substation, extension of Mandsaur substation, extension of Shujalpur substation and extension of Ashta substation, shall be conventional Air Insulated Switchgear (AIS) type generally conforming to the requirements of CEA (Technical Standards for Construction of Electrical Plants and Electric Lines) Regulations 2022, as amended from time to time. Other CEA Regulations and MoP guidelines, as applicable, shall also be followed.

**B.1.0 Salient features of Substation Equipment and Facilities**

The design and specification of substation equipment are to be governed by the following factors:

**B.1.1 Insulation Coordination**

The system design parameters for substations/switchyards shall be as given below:

Sl. No.	Description of parameters	765/400/220/132kV Kurawar PS				765kV Mandsaur Extn.	400kV Shujalpur Extn.	400kV Ashta (MPPTCL) Extn.
		765 kV System	400 kV System	220 kV System	132 kV System	765 kV System	400 kV System	400 kV System
1.	System operating voltage	765kV	400kV	220kV	132kV	765kV	400kV	400kV
2.	Maximum voltage of the system (rms)	800kV	420kV	245kV	145kV	800kV	420kV	420kV
3.	Rated frequency	50Hz	50Hz	50Hz	50Hz	50Hz	50Hz	50Hz
4.	No. of phase	3	3	3	3	3	3	3
5.	Rated Insulation levels							
i)	Impulse withstand voltage for (1.2/50 micro sec.) for Equipment other than Transformer and reactor for Insulator String	2100kVp	1425kVp	1050kVp	650kVp	2100kVp	1425kVp	1425kVp
		2100kVp	1550kVp	1050kVp	650kVp	2100kVp	1550kVp	1550kVp
ii)	Switching impulse withstand voltage (250/2500 micro sec.) dry and wet	1550kVp	1050kVp	--	--	1550kVp	1050kVp	1050kVp
iii)	One minute power frequency dry							

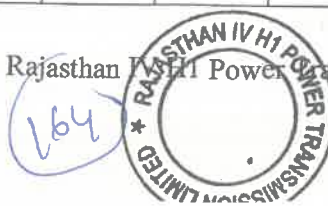

Sl. No.	Description of parameters	765/400/220/132kV Kurawar PS				765kV Mandsaur Extn.	400kV Shujalpur Extn.	400kV Ashta (MPPTCL) Extn.
		765 kV System	400 kV System	220 kV System	132 kV System	765 kV System	400 kV System	400 kV System
	withstand voltage (rms)	830kV	630kV	460kV	275kV	830kV	630kV	630kV
6.	Corona extinction voltage	508 kV	320kV	--	--	508 kV	320kV	320kV
7.	Max. radio interference voltage for frequency between 0.5 MHz and 2 MHz	2500 micro-volts at 508 kV rms	1000 micro-volts at 266kV rms	1000 micro-volts at 156 kV rms	500 micro-volts at 92 kV rms)	2500 micro-volts at 508 kV rms	1000 micro-volts at 266kV rms	1000 micro-volts at 266kV rms
8.	Minimum creepage distance for insulator string/ longrod insulators/ outdoor bushings	24800 mm (31mm /kV)	13020 mm (31mm /kV)	7595 mm (31mm /kV)	4495 mm (31mm /kV)	24800 mm (31mm/ kV)	13020 mm (31mm/ kV)	13020 mm (31mm/kV)
9.	Minimum creepage distance for switchyard equipment	20000 mm (25mm /kV)	10500 mm (25mm /kV)	6125 mm (25mm /kV)	3625 mm (25mm /kV)	20000 mm (25mm/ kV)	10500 mm (25mm/ kV)	10500 mm (25mm/kV)
10.	Max. fault current	50 kA	63kA	50kA	40kA	50kA	63kA	63kA
11.	Duration of fault	1 sec	1 Sec	1 Sec	1 Sec	1 Sec	1 Sec	1 Sec

### B.1.2 Switching Scheme

The switching schemes, as mentioned below, shall be adopted at various voltage levels of substation/switchyard:

Substation	765kV side	400kV side	220kV side	132kV side
765/400/220/132 kV Kurawar PS (AIS)	One and half breaker	One and half breaker	Double Main and Transfer	Single Main and Transfer
765kV Mandsaur S/S (AIS)	One and half breaker	N/A	N/A	N/A
400kV Shujalpur S/S (AIS)	N/A	One and half breaker	N/A	N/A
400kV Ashta (MPPTCL) S/S	N/A	As per existing	N/A	N/A

Notes: -

- i) For one and half breaker switching scheme, any double circuit line consisting of two numbers of feeders and originating from the same transmission or



generating switchyard shall not be terminated in one diameter.

- ii) Two transformers of same HV rating shall not be connected in the same diameter and similarly two bus reactors of same HV rating shall also not be connected in the same diameter.
- iii) A diameter in one and half breaker scheme is a set of 3 circuit breakers with associated isolators, earth switches, current transformers etc. for controlling 2 (two) numbers of feeders.
- iv) Connection arrangement of Switchable Line reactors shall be such that it can be used as Line reactor as well as Bus reactor with suitable NGR bypass arrangement.
- v) **Provision for Bus sectionalizer:**  
Space for One (1) set of future bus sectionalizer for 765kV and 400 kV shall comprise 2 nos. of bus sectionalizer bays with associated Circuit Breakers, Isolators and Current Transformers for both buses.  
Space for One (1) set of bus sectionalizer for 220 kV shall comprise 2 nos. of bus sectionalizer bays with associated Circuit Breakers, Isolators and Current Transformers for both buses.
- vi) TSP shall plan distribution of line and transformer feeders to bus bar in such a way that all power can be evacuated successfully without crossing thermal limit at any point of bus-bar.
- vii) For AIS type substation, TSP shall keep space provisions for future elements such that interconnection arrangement to the corresponding future bays can be done with overhead AIS type connection without any cable/ GIS duct.
- viii) 765kV line bays shall be constructed such that provision is kept for future switchable line reactors.
- ix) **765kV Mandsaur Extn:** It is envisaged that the termination of one circuit of 765kV Mandsaur-Kurawar D/C at Mandsaur S/S under present scope shall be terminated in diameter for which Tie bay is to be constructed by the TSP of "Transmission system for evacuation of power from Rajasthan REZ Ph-IV (Part-2: 5.5 GW) (Jaisalmer/Barmer Complex): Part D".  
Other circuit of 765kV Mandsaur-Kurawar D/C at Mandsaur S/S shall be terminated in new diameter for which Main and Tie bays are to be constructed under the present scope.
- x) 400 kV Shujalpur (PG) Extn: One circuit of 400 kV Mandsaur - Shujalpur D/c Line shall be terminated in bay no. 416 for which main bay is to be constructed. Other circuit of 400 kV Mandsaur - Shujalpur D/c Line shall be terminated in bay no. 419 and 420 for which main and tie bays are to be constructed under present scope. Refer attached GA drawing (Drg. No. TR202112-1001509- SS1612-ELECTRICAL).

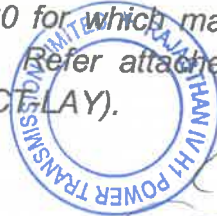



**B.2.0 Substation Equipment and facilities (Voltage level as applicable):**

The switchgear shall be designed and specified to withstand operating conditions and duty requirements. All equipment shall be designed considering the following capacity.

Sl. No	Description of bay	765/400/220kV Kurawar S/S				765kV Mandsaour Extn.	400kV Shujalpur Extn.	400kV Ashta (MP) Extn.
		765kV	400kV	220 kV	132 kV	765kV	400kV	400kV
1.	Bus Bar	4000A	4000A	3000A	3000 A	As per existing	As per existing	As per existing
2.	Line bay	3150A	3150A	1600A	--	3150A	3150A	3150A
3.	ICT bay	3150A	3150A	1600A	1250 A	N/A	N/A	N/A
4.	Reactor bay	3150A	3150A	N/A	N/A	N/A	N/A	N/A
5.	Bus Coupler bay	N/A	N/A	3000A	N/A	N/A	N/A	N/A
6.	Transfer Bus coupler bay	N/A	N/A	1600A	1250 A	N/A	N/A	N/A

**B.2.1 (765/√3)/(400/√3)/33 kV, Single Phase Autotransformer**

500 MVA, (765/√3)/(400/√3)/33kV, 1-phase autotransformer (including arrangement for 3-phase bank formation of 1500 MVA) shall conform to CEA's "Standard Specifications and Technical Parameters for Transformers and Reactors (66 kV and above Voltage Class)" as amended upto date available on CEA website.

Spare 1-phase Transformer unit shall be placed and connected in such a way that the spare unit can be utilized to replace any unit of any of the transformer banks (including for future transformer banks) without physically moving it.

**B.2.2 (765/√3) kV, Single Phase Shunt Reactor**

80 MVAR and 110MVAR, 765/√3 kV, 1-Phase Reactor (including arrangement for 3-phase bank formation of 240MVAR and 330MVAR respectively) Reactor shall conform to CEA's "Standard Specifications and Technical Parameters for Transformers and Reactors (66 kV and above Voltage Class)" as amended upto date available on CEA website.

Spare 1-phase Shunt Reactor units shall be placed and connected in such a way that the spare unit can be utilized for all the bus and switchable line reactor banks (including for future reactor banks) without its physical movement.

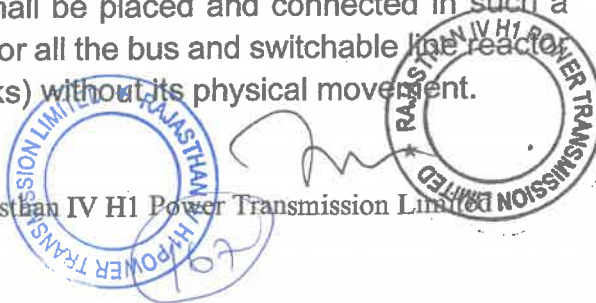

### Neutral Grounding Reactor and Surge Arrester for 765 kV Line Reactors (as applicable):

The neutral of the line reactors (wherever provided) shall be grounded through adequately rated Neutral Grounding Reactors (NGR) to facilitate single phase auto-reclosure, provided that the NGR shall be provided with suitable bypass arrangement so that the line reactor can be used as Bus reactor as and when required. The neutral of bus reactor shall be solidly grounded.

NGR shall be oil filled or dry type air core for outdoor application. NGR shall conform to CEA's "Standard specifications and technical parameters of transformers and reactors (66kV and above Voltage Class)", as amended upto date. Technical parameters of NGR shall be as specified in Annexure-A of above-mentioned document.

The surge arresters (rated voltage of arrester in co-ordination with ohmic value of NGR shall be decided by the TSP) shall be provided and physically located between the neutral of shunt reactor (brought out at 145kV class bushing) and neutral grounding reactor. The surge arresters shall be of Station Medium (SM) class duty gapless Metal oxide (ZnO) type conforming in general to IEC-60099-4. Arresters shall be hermetically sealed units, of self-supporting construction, suitable for mounting on structures.

The Ohmic value of NGR for Line Reactors shall be as follows:

Sl. No.	Line Name	NGR value
1.	Mandsaur – Kurawar 765kV D/c Line with 240MVAR switchable line reactor (SLR) on each ckt at both ends	400 Ohms

#### B.2.3 400/220/33kV, 3-phase Autotransformer

500MVA, 400/220/33kV, 3-phase autotransformer shall conform to CEA's "Standard Specifications and Technical Parameters for Transformers and Reactors (66 kV and above Voltage Class)" as amended up to date available on CEA website.

#### B.2.4 220/132kV, 3-phase Autotransformer

200MVA, 220/132kV, 3-phase autotransformer shall conform to CEA's "Standard Specifications and Technical Parameters for Transformers and Reactors (66 kV and above Voltage Class)" as amended up to date available on CEA website.

#### B.2.5 420kV, 3-Phase, Shunt Reactor

125MVAR, 420 KV, 3-Phase Reactor shall conform to CEA's "Standard Specifications and Technical Parameters for Transformers and Reactors (66 kV and above Voltage Class)" as amended up to date available on CEA website.

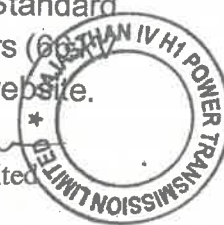
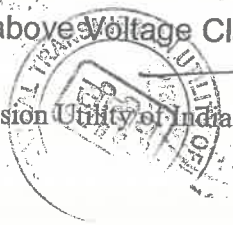

**B.2.6 765kV, 400kV, 220kV and 132 kV AIS Substation equipment (as applicable)****B.2.6.1 Circuit Breakers (AIS)**

The circuit breakers and accessories shall conform to IEC: 62271-100, IEC: 62271-1 and shall be of SF6 Type. The circuit breakers shall be of class C2-M2 (as per IEC) with regard to restrike probability during capacitive current breaking and mechanical endurance. Each breaker shall have two sets of trip circuits which would be connected to separate DC supplies for greater reliability. The rated break time shall not exceed 40ms for 765kV and 400 kV circuit breakers and 60ms for 220 kV and 132 kV circuit breakers. The Circuit breakers controlling 765 kV lines shall be provided with pre-insertion closing resistor of about 450 ohms maximum with 9 ms insertion time or Controlled Switching Device. The Circuit breakers controlling 400kV lines shall be provided with pre insertion closing resistor of about 400 ohms with 8 ms insertion time or Controlled Switching Device (CSD) for lines longer than 200 km. Circuit breakers shall be provided with single phase and three phase auto reclosing. The short line fault capacity shall be same as the rated capacity and this is proposed to be achieved without use of opening resistors. The controlled switching device shall be provided in Circuit breakers of switchable line reactor bay and in Main and Tie bay circuit breakers of line with non-switchable line reactors, Bus reactors and Transformers of voltage class 400kV and above.

**B.2.6.2 Isolators (AIS)**

The isolators shall comply to IEC 62271-102 in general. 765 kV isolator design shall be double break or vertical break or knee-type. 400 kV, 220 kV and 132 kV isolators shall be double break type. All isolators and earth switches shall be motor operated. Earth switches shall be provided at various locations to facilitate maintenance. Isolators shall be of extended mechanical endurance class - M2 and suitable for bus transfer current switching duty as per IEC-62271-102. Main blades and earth blades shall be interlocked and interlock shall be fail safe type. Earthing switches used in lines for 132 kV and higher voltages shall be suitable for induced current switching duty as defined for Class-B.

**B.2.6.3 Current Transformers (AIS)**

Current Transformers shall comply with IEC 61869 in general. All ratios shall be obtained by secondary taps only. Generally, Current Transformers (CT) for 765kV and 400kV shall have six cores (four for protection and two for metering). 220kV and 132kV Current Transformers shall have five cores (four for protection and one for metering). The burden and knee point voltage shall be in accordance with the requirements of the system including possible feeds for telemetry. Accuracy class for protection core shall be PX and for metering core it shall be 0.2S. The rated burden of cores shall be closer to the maximum burden requirement of metering and protection system (not more than 20VA for metering core) for better sensitivity and



169



accuracy. The instrument security factor shall be less than 5 for CTs upto 400kV and less than 10 for CTs of 765kV voltage class.

#### B.2.6.4 Capacitive Voltage Transformers (AIS)

Capacitive Voltage transformers shall comply with IEC 61869 in general. These shall have three secondaries out of which two shall be used for protection and one for metering. Accuracy class for protection cores shall be 3P and for metering core shall be 0.2. The Capacitive voltage transformers on lines shall be suitable for Carrier Coupling. The Capacitance of CVT for 400kV, 220kV and 132kV shall be of 4400/8800 pF depending on PLCC requirements whereas the Capacitance of CVT for 765kV shall be 8800 pF. The rated burden of cores shall be closer to the maximum burden requirement of metering and protection system (not more than 50VA for metering core) for better sensitivity and accuracy.

#### B.2.6.5 Surge Arresters (AIS)

624kV and 336kV Station High (SH) duty gapless type Surge arresters with thermal energy ( $W_{th}$ ) of minimum 13 kJ/kV and 12 kJ/kV conforming to IEC 60099-4 in general shall be provided for 765 kV and 400 kV systems respectively. 216 kV and 120kV Station Medium (SM) duty gapless type Surge arresters with thermal energy ( $W_{th}$ ) of minimum 7 kJ/kV conforming to IEC 60099-4 in general shall be provided for both 220 kV and 132 kV systems respectively. Other characteristics of Surge arrester shall be chosen in accordance with system requirements. Surge arresters shall be provided near line entrances, Transformers and Reactor so as to achieve proper insulation coordination. Surge Arresters shall be provided with porcelain/polymer housing fitted with pressure relief devices. A leakage current monitor with surge counter shall be provided with each surge arrester.

#### B.2.7 Protection Relaying and Control System

The protective relaying system proposed to be provided for transmission lines, auto-transformers, reactors and bus bars to minimize the damage to the equipment in the events of faults and abnormal conditions, is dealt in this section. All main protective relays shall be numerical type with IEC 61850 communication interface and should have interoperability during integration of numerical relays to communicate over IEC61850 protocol with RTU/SAS/IEDs of different OEMs. All numerical relays shall have built in disturbance recording feature.

The protection circuits and relays of transformer and reactor shall be electrically and physically segregated into two groups each being independent and capable of providing uninterrupted protection even in the event of one of the protection groups failing, to obtain redundancy, and to take protection systems out for maintenance while the equipment remains in service.

#### A) TRANSMISSION LINES PROTECTION

Central Transmission Utility of India Limited



Rajasthan HV H1 Power Transmission Limited





765kV and 400kV lines shall have Main-I numerical three zone distance protection scheme with carrier aided inter-tripping feature. 765kV and 400kV lines shall also have Main-II numerical distance protection scheme like Main-I but from different make that of Main-I. The Main-I and Main-II protection relays of same make may be provided only if they are of different hardware and manufacturing platform or different principle of operation.

However, Line Current Differential relay (with back up distance protection feature) as Main-I and Main-II shall be considered at both ends for short lines (line length below 30kM) having Fibre Optic communication link. Differential relay at remote end shall be provided by the TSP. Associated power and control cabling and integration with SAS at remote end shall be provided by respective bay owner.

In case of loop in loop out of transmission lines, the existing protection scheme shall be studied and suitable up-gradation (if required) shall be carried out.

Further, all 765kV and 400kV lines shall be provided with single and three phase auto-reclosing facility to allow reclosing of circuit breakers in case of transient faults. These lines shall also be provided with distance to fault locators to identify the location of fault on transmission lines.

All 765kV and 400kV lines shall also be provided with two stages over voltage protection. Over voltage protection and distance to fault locator may be provided as in-built feature of Main-I and Main-II protection relays. Auto reclose as built-in function of Bay Control Unit (BCU) is also acceptable.

The Main-I and Main-II protection relays shall be fed from separate DC sources and shall be mounted in separate panels.

For 765kV and 400kV transmission lines, directional IDMT earth fault relay should be provided as standalone unit or in-built feature of Main-I and Main-II feature.

## B) AUTO TRANSFORMER PROTECTION

These shall have the following protections:

- i) Numerical Differential protection
- ii) Numerical Restricted earth fault protection
- iii) Numerical Back-up Over-current and earth fault protection on HV and IV side
- iv) Numerical Over fluxing protection on HV and IV side
- v) Numerical Overload alarm

Further, Numerical Back-up Over-current and earth fault protection on HV and IV side of autotransformer shall not be combined with other protective functions in the main relays and shall be independent relays. Besides these, power transformers shall also be provided with Buchholz relay, protection against high oil temperature and pressure relief device etc.

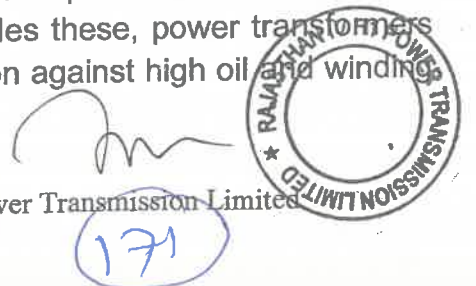
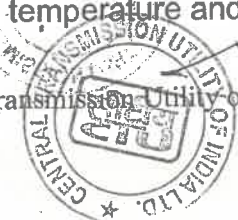

Suitable monitoring, control (operation of associated circuit breaker and isolator) and protection for LT auxiliary transformer connected to tertiary winding of auto-transformer for the purpose of auxiliary supply shall be provided. The over current and other necessary protection shall be provided for the auxiliary transformer. These protection and control may be provided as built in feature either in the bay controller to be provided for the auxiliary system or in the control and protection IEDs to be provided for autotransformer.

**C) 765 KV AND 400 KV REACTOR PROTECTION**

Reactor shall be provided with the following protections:

- i) Numerical Differential protection.
- ii) Numerical Restricted earth fault protection
- iii) Numerical Back-up impedance protection

Besides these, reactors shall also be provided with Buchholz relay, Magnetic Oil Gauge (MOG) with low oil level alarm, protection against oil and winding temperatures and pressure relief device, etc.

**D) BUS BAR PROTECTION**

The high speed low impedance type bus bar differential protection, which is essential to minimize the damage and maintain system stability at the time of bus bar faults, shall be provided for 765kV, 400kV, 220kV and 132 kV buses. Duplicated bus bar protection is envisaged for 765 kV and 400kV bus-bar protection. Bus bar protection scheme shall be such that it operates selectively for each bus and incorporate necessary features required for ensuring security. The scheme shall have complete bus bar protection for present as well as envisaged future bays i.e. input / output modules for future bays shall also be provided.

Bus Bar protection system for new substation shall be de-centralized (distributed) type.

In case, the bus section is provided, then each side of bus section shall have separate set of bus bar protection schemes.

For existing substations, the existing bus bar protection shall be augmented as per requirement.

**a) Local Breaker Back up Protection**

This shall be provided for each 765kV, 400kV, 220kV and 132kV circuit breakers and will be connected to de-energize the affected stuck breaker from both sides.

Notes:

1. LBB and REF relays shall be provided separately from transformer differential relay.



221

2. LBB relay may also be provided as built-in protection function of distributed bus bar protection scheme; however, in such case separate LBB relay shall be provided for tie bays (in case of One and Half breaker scheme).
3. Over fluxing and overload protection can be provided as built-in feature of differential relay.
4. In 765kV and 400kV switchyard, if spare bay of half diameter is identified as future, Tie CB relay panel shall be with Auto-reclosure feature.

### B.2.8 Substation Automation System

- a) For all the new substations, state of art Substation Automation System (SAS) conforming to IEC-61850 shall be provided. The distributed architecture shall be used for Substation Automation system, where the controls shall be provided through Bay control units. The Bay control unit is to be provided bay wise for voltage level 132kV and above. All bay control units as well as protection units are normally connected through an Optical fibre high speed network. The control and monitoring of circuit breaker, dis-connector, re-setting of relays etc. can be done from Human Machine Interface (HMI) from the Relay Panel Room.

The functions of control, annunciation, disturbance recording, event logging and measurement of electrical parameters shall be integrated in Substation Automation System.

At new substations, the Substation Automation System (SAS) shall be suitable for operation and monitoring of the complete substation including proposed future bays/elements.

In existing substations with Substation automation system (SAS), augmentation of existing SAS shall be done for bays under present scope.

In existing Substations where Substation automation is not provided, control functions shall be done through control panels.

Necessary gateway and modems (as required) shall be provided to send data to RLDC/SLDC as per their requirement and shall be provisioned with 2+2 redundancy i.e. 2 channels for Main Control Centre and 2 channels for Backup Control Centre. In order to meet this requirement, suitable redundancy at port and card level need to be ensured by the TSP to avoid any single point of failure which may lead to interruption in real-time grid operation. Accordingly, all the hardware for communication services of station as stated above shall support dual redundancy for data transmission of station to respective main and backup RLDCs. Any augmentation work at RLDC/SLDC is excluded from TSP's scope. However, all the configuration work at substation end required to send data to RLDC/SLDC shall be in the scope of TSP.

#### b) Time synchronization equipment

Time synchronization equipment complete in all respect including antenna, cable, processing equipment required to receive time signal through GPS or from National Physical Laboratory (NPL) through INSAT shall be provided at new substations.

This equipment shall be used to synchronize SAS and IEDs etc.



173



**B.3.0 Substation Support facilities**

Certain facilities required for operation and maintenance of substations as described below shall be provided at new substation. In existing substation, these facilities have already been provided and would be extended/ augmented as per requirement.

**B.3.1 AC and DC power supplies**

For catering the requirements of three phase and single phase AC supply and DC supply for various substation equipment (for present and future scope), the following arrangement is envisaged:-

- i) For LT Supply at each new Substation, two (2) nos. of LT Transformers (minimum 800kVA for substations with highest voltage rating as 765kV) shall be provided which shall be fed from two independent sources as per the CEA (Technical Standards for Connectivity to the Grid) Regulations, 2007.

Metering arrangement with Special Energy Meters (SEMs) shall be provided by TSP at 33kV tertiary of Transformer for drawing auxiliary supply at new substation. Such SEMs shall be provided by CTU at the cost of the TSP. Accounting of such energy drawn by the TSP shall be done by RLDC/RPC as part of Regional Energy Accounting.

Additionally, Active Energy Meters may be provided at the same point in the 33kV tertiary of Transformer by local SEB/DISCOM for energy accounting.

- ii) 2 sets of 220V battery banks for control and protection and 2 sets of 48V battery banks for PLCC/ communication equipment shall be provided at each new Substation. Each battery bank shall have a float-cum-boost charger.

At new substation, sizing of 220 V battery and battery charger shall be done based on the number of bays specified (including future bays) as per CEA Regulations and relevant IS. 2 sets of 48 V battery banks for PLCC and communication equipment for present and future scope shall be provided at each new Substation with at least 10-hour battery backup and extended backup, if required.

- iii) Suitable AC and DC distribution boards and associated LT Switchgear shall be provided at new substation.

For new substation, following switch boards shall be considered with duplicate supply with bus coupler/ sectionalizer and duplicate outgoing feeders except for Emergency lighting distribution board which shall have only one incoming feeder:

- (a) 415V Main Switch board – 1 nos.  
(b) AC distribution board – 1 nos.  
(c) Main lighting distribution board – 1 no.  
(d) Emergency lighting distribution board – 1 no.  
(e) 220 Volt DC distribution board – 2 nos.



Handwritten signature



(f) 48 Volt DC distribution board – 2 nos.

Sizing of LT Switchgear shall be suitable to cater the requirement for all present and future bays. AC and DC distribution boards shall have equipped modules for all the feeders (including future as specified).

- iv) At new Substation, one no. of DG set (minimum 500kVA for substations with highest voltage rating as 765kV) shall be provided for emergency applications.
- v) For substation extensions, existing facilities shall be augmented as required.

### **B.3.2 Fire Fighting System**

Fire-fighting system for substation including transformer and reactor shall conform to CEA (Measures Relating to Safety and Electric Supply) Regulations, 2023.

Further, adequate water hydrants and portable fire extinguishers shall be provided in the substations. The main header of firefighting system shall be suitable for extension to bays covered under the future scope; necessary piping interface in this regard shall be provided.

At existing substations, the fire-fighting systems as available shall be extended to meet the additional requirements.

### **B.3.3 Oil evacuating, filtering, testing and filling apparatus**

To monitor the quality of oil for satisfactory performance of transformers, shunt reactors and for periodical maintenance necessary oil evacuating, filtering, testing and filling apparatus would be provided at new substations. Oil storage tanks of adequate capacities for storage of transformer oil would be provided.

Online Transformer Oil Drying Out System shall be provided in line with the provisions of Standard Specification and Technical Parameters for Transformers and Reactors (66 kV & above Voltage Class) as amended up to date available on CEA website.

### **B.3.4 Illumination**

Normal and emergency AC and DC illumination shall be provided adequately in the control room and other buildings of the substation. The switchyard shall also be provided with adequate illumination.

The Lighting of the entire control room building, fire-fighting pump house, other building (if any) and switchyard shall be done by LED based low power consumption luminaries.

### **B.3.5 Control Room**

For the new substation, substation control room shall be provided to house substation work stations for station level control (SAS) along with its peripheral and recording equipment, AC and DC distribution board, DC batteries and associated

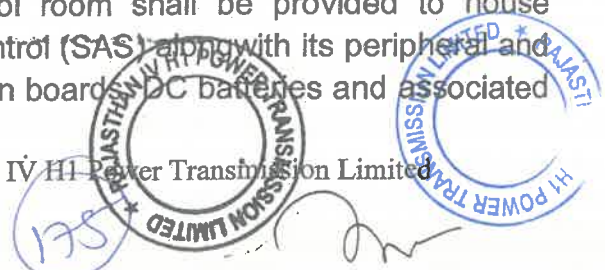
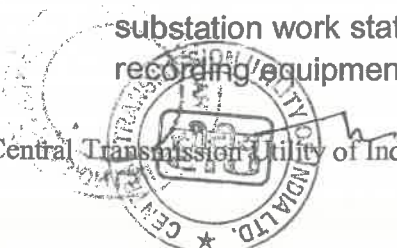

battery chargers, Fire Protection panels, Telecommunication panels and other panels as per requirements. Air conditioning shall be provided in the building as functional requirements. Main cable trenches from the control room shall have adequate space provision for laying of cables from control room for all the future bays also.

At existing substations, the adequacy of size of control room shall be ascertained and the same shall be augmented as per requirement.

### B.3.6 Control Concept

All the EHV circuit breakers in substation/switching stations shall be controlled and synchronized from the switchyard control room/remote control center. Each breaker would have two sets of trip circuits which would be connected to separate DC supplies for greater reliability. All the isolators shall have control from remote/local whereas the earth switches shall have local control only.

### B.3.7 Visual monitoring system (VMS) for watch and ward of substation premises:

Visual monitoring system for effective watch and ward of substation premises shall cover all the transformers and reactors, all other major AIS Equipment (such as CB, isolators, CT, CVT, SA etc. as applicable), GIS bays, panel room, all the gates of switchyard and all entry and exit points of control room building and accordingly the location of cameras shall be decided. In addition to the gates of the switchyard, the cameras shall also be located around the boundaries at suitable locations. The camera shall be high-definition color CCD camera with night vision feature. The VMS data partly/completely shall be recorded (minimum for 15 days) at least @25fps (or better) and stored on network video recorder. The system shall use video signals from various cameras installed at different locations, process them for viewing on workstations/monitors in the control room and simultaneously record all the cameras. The VMS data should go only to the intended personnel/facility and not to the remote server of the Camera (VMS supplier).

Mouse/keyboard controllers shall be used for pan, tilt, zoom and other functions of the desired camera. The Visual Monitoring System shall have provision of WAN connectivity for remote monitoring.

All camera recordings shall have Camera ID and location/area of recording as well as date/time stamp. The equipment should generally conform to Electromagnetic compatibility requirement for outdoor equipment in EHV substation.

At existing substations, the visual monitoring system if available shall be augmented as per existing or better specification as required.

## B.4 General Facilities

- a) Line Gantry/Towers are envisaged for bays under present scope only. However, for adjacent future line bay, tower shall be designed for extension (considering Quad conductors for 765kV and 400kV future lines and Twin conductor for 220 kV future lines) wherever applicable.



- b) Bay extension works at existing substation shall be executed by TSP in accordance with the requirement/provisions mentioned above. However, interface points shall be considered keeping in view the existing design/arrangement at the substation.
- c) TSP has to arrange for construction power and water on its own.
- d) All outdoor steel structures including anchor/foundation bolts shall be fully galvanized. The weight of the zinc coating shall be at least 610 g/m<sup>2</sup>, however, for coastal/creek regions it shall be at least 900 g/m<sup>2</sup>.
- e) In 765kV and 400kV switchyard, if spare bay of half diameter is identified as future, all the equipment for Tie and Future bay shall be designed considering the current rating of line bay i.e. 3150A.
- f) Boundary wall shall be brick masonry wall with RCC frame or Stone masonry wall or Precast RCC wall under present scope along the property line of complete substation area including future switchyard area to prevent encroachment and unauthorized access. Minimum height of the boundary wall shall be of 1.8 m from finished ground level (FGL).
- g) All electrical equipment shall be installed above Highest Flood Level and where such equipment is not possible to be installed above Highest Flood Level, it shall be ensured that there is no seepage or leakage or logging of water.

## B.5 EXTENSION OF EXISTING SUBSTATION

The following drawings/details of existing substation is attached with the RFP documents for further engineering by the bidder.

Sl. No.	Drawing Title	Drawing No./Details	Rev. No.
<b>A.</b>	<b>400kV Ashta (MPPTCL) S/S</b>		
1.0	Single Line Diagram	Enclosed	
2.0	General Arrangement	XII-N08-1818	R20
3.0	Earthmat Layout	-	-
4.0	Visual Monitoring System	-	-
5.0	Bus Bar Protection	-	-
6.0	Substation Automation System (SAS)		
7.0	Earthmat Arrangement	XII-N08-1818	R20
8.0	Foundation Plan and Cable	XII-N08-1818	

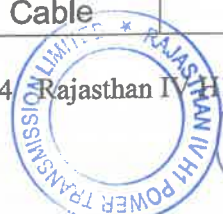
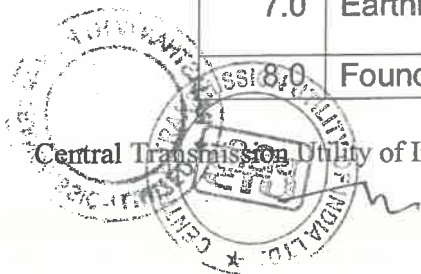

Transmission Service Agreement

	Tranches		
B.	400kV Shujalpur S/S		
1.0	Single Line Diagram	<b>Enclosed (revised drawing attached)</b>	-
2.0	General Arrangement	<b>TR202112-1001509-SS1612-ELECT-LAY (revised drawing attached)</b>	<u>A</u>
3.0	Earthmat Layout	-	-
4.0	Visual Monitoring System	<b>Make: PELCO Model: Nice vision</b>	-
5.0	Bus Bar Protection	<b>GE/PU-P743 &amp; CUP741, Distributed Type</b>	-
6.0	Substation Automation System (SAS)	<b>GE S1 AGILE</b>	-

Bidder is also advised to visit the substation sites and acquaint themselves with the topography, infrastructure such as requirement of roads, cable trench, drainage etc. and also the design philosophy.

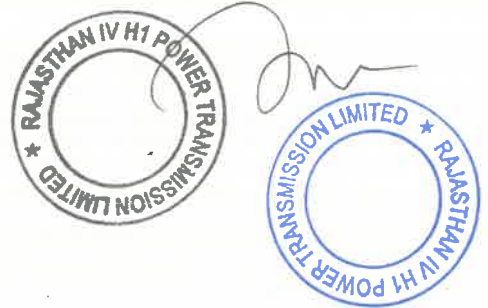

178



**SPECIFIC TECHNICAL REQUIREMENTS FOR COMMUNICATION**

The communication requirement shall be in accordance to CEA (Technical Standards for Communication System in Power System Operations) Regulations, 2020, CEA (Technical Standards for Construction of Electrical Plants and Electric Lines) Regulations, 2022, CERC (Communication System for inter-State transmission of electricity) Regulations, 2017, and CEA (Cyber Security in Power Sector) Guidelines, 2021, all above documents as amended from time to time.

The complete ISTS communication system commissioned by TSP under the RFP shall be the asset of ISTS and shall be available for usage of ISTS requirements as suggested by CTU from time to time.

The communication services viz. SCADA, VoIP, PMU, AGC and AMR (wherever applicable) have been identified as critical services and therefore shall be provisioned with 2+2 redundancy i.e. 2 channels for Main Control Centre and 2 channels for Backup Control Centre. In order to meet this requirement, suitable redundancy at port and card level need to be ensured by the TSP to avoid any single point of failure which may lead to interruption in real-time grid operation.

PMU to PDC communication (wherever required) shall be through 2 channels to the PDC (main) as there is no backup PDC at present.

Accordingly, all the hardware for communication services of station as stated above shall support dual redundancy for data transmission of station to respective main and backup RLDCs.

The protections for the transmission line and the line compensating equipment shall have a hundred percent backup communication channels i.e. two channels for tele-protection in addition to one channel for speech plus data for each direction.

In order to meet the requirement for grid management and operation of substations, Transmission Service Provider (TSP) shall provide the following:

**C.1.0 Establishment of 765/400 kV (2x1500 MVA), 400/22 kV (2x500 MVA) and 220/132 kV (3x200 MVA) Kurawar S/s with 2x330 MVAR 765kV bus reactor and 1x125 MVAR, 420 kV bus reactor.**

- (I) TSP shall supply, install and commission one or more FODP (120 F or higher) alongwith panel and approach Cable (24F each) with all associated hardware fittings from gantry tower to Control Room for all the incoming lines envisaged under the present scope.
- (II) TSP shall supply, install and commission One or more STM-16 (FOTE) equipment alongwith panel/s supporting minimum Seven (7) directions with MSP (Multiplex Section Protection – 1+1, excluding local patching). These directions shall exclude protected (1+1) local patching among equipment (if any). Communication Equipment shall be provided with necessary interfaces to meet the voice and data communication requirement among

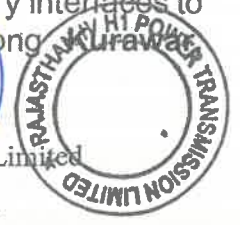
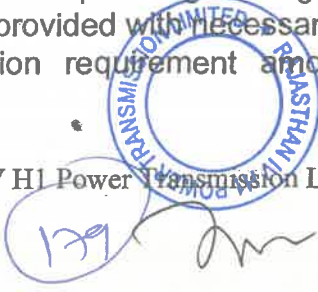

**Mandsaur, Ashta (MP), and Shujalpur (PG) S/s.** The suitable DC Power Supply and backup to be provided for communication equipment.

- (III) FODP and FOTE equipment with panels shall be provided in Control Room of Kurawar. FOTE and FODP equipment can be accommodated in same panel to optimize space.
- (IV) The new communication equipment under the present scope shall be compatible for integration with existing regional level centralized Network Management System (NMS). The local configuration of the new communication equipment shall be the responsibility of TSP. The configuration work in the existing centralized NMS for integration of new Communication equipment shall be done by Regional ULDC Team, however all the necessary support in this regard shall be ensured by TSP.
- (V) TSP shall supply, install and commission Firewall in redundant mode (1+1) in line with the specification attached at **Annexure F.1**.
- (VI) The maintenance of all the communication equipment and software thereof including FOTE, FODP, approach cable, PMU, DCPS alongwith Battery Bank and Firewall shall be the responsibility of TSP.

**C.2.0 Mandsaur – Kurawar 765 kV D/c line**

On Mandsaur – Kurawar 765 kV D/C line, TSP shall supply, install and commission One (1) no. OPGW cable containing 24 Fibres (24F) on one E/W peak and conventional earth wire on other E/W peak.

The TSP shall install this OPGW from gantry of Mandsaur up to the gantry of Kurawar S/s with all associated hardware including Vibration Dampers, mid-way and gantry Joint Boxes (called **OPGW Hardware** hereafter) and finally terminate in Joint Boxes at end Substations. The transmission line length is **235 kms** (approx.), repeater will be required. To meet link budget requirement of Mandsaur – Kurawar link (including service loops and sag etc.) 1 set of FOTE at repeater station to be provided by TSP.

TSP shall finalize the location of repeater station depending upon the actual site conditions. Further TSP shall comply to the requirements mentioned as per **Appendix-F.1**

Maintenance of OPGW Cable, OPGW Hardware and repeater equipment and items associated with repeater shelter shall be responsibility of TSP.

**C.3.0 2 nos. of 765 kV line bays at Mandsaur S/s for termination of Mandsaur – Kurawar 765 kV D/c line.**



- (I) TSP shall supply, install and commission 1 no. FODP (72F or higher) alongwith panel and required Approach Cable (24F) with all associated hardware fittings from gantry tower to Bay Kiosk and from the Bay Kiosk to Control room.
- (II) TSP shall supply, install and commission One STM-16 (FOTE) equipment alongwith panel/s supporting minimum three (3) directions with MSP (Multiplex Section Protection – 1+1, excluding local patching) with necessary interfaces to meet the voice and data communication requirement between Mandsaur and Kurawar S/s. The suitable DC Power Supply and backup to be provided for communication equipment.
- (III) FOTE/FODP panel shall be installed in the new Bay Kiosk /Switchyard Panel Room (SPR). The FOTE under present scope shall be integrated by TSP with the existing FOTE at control room of Mandsaur S/s which shall be communicating with respective control center. TSP to provide necessary FODP sub rack / Splice trays/ Patch cords etc. and optical interfaces/equipment in the existing FOTE/FODP panels in control room for integration with the existing FOTE for onwards data transmission.

In case spare optical direction is not available in the existing FOTE at the control room, the TSP shall coordinate with station owner to reconfigure the directions in existing FOTE at control room. Alternatively, The TSP may integrate the FOTE under the present scope with existing FOTE in the nearby Kiosk connected to the control room FOTE (if available with spare direction). For this purpose, TSP shall provide necessary FODP sub rack / Splice trays/ Patch cords etc. and suitable optical interfaces/ equipment in the existing FOTE/FODP panels in another Kiosk (SPR).

- (IV) FOTE and FODP can be accommodated in same panel to optimize space.
- (V) The new communication equipment under the present scope shall be compatible for integration with existing regional level centralized Network Management System (NMS). The local configuration of the new communication equipment shall be the responsibility of TSP. The configuration work in the existing centralized NMS for integration of new Communication equipment shall be done by Regional ULDC Team, however all the necessary support in this regard shall be ensured by TSP.
- (VI) The maintenance of all the communication equipment and software thereof including FOTE, PMU, FODP, approach cable, DCPS alongwith Battery Bank shall be the responsibility of TSP.

#### C.4.0 LILO of Indore – Bhopal 765 kV S/c line at Kurawar.

On LILO of Indore – Bhopal 765 kV S/c line at Kurawar, TSP shall supply, install & commission OPGW and earthwire as per

Tower Configurations.



181

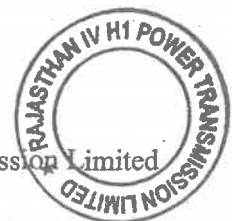



(i) For Double Circuit Tower configuration: two (2) no. OPGW cables containing 24 Fibres (24F) on both earthwire peaks (one on each E/W peak) (2x24F OPGW) in place of conventional earthwire.

The TSP shall install OPGW cables from gantry of Kurawar S/s up to the LILO tower with all associated hardware including Vibration Dampers, mid-way & gantry Joint Boxes (called OPGW Hardware hereafter) and finally terminate in Joint Boxes at Kurawar S/s. The transmission line length is 15kms (approx.) After LILO, if fiber length for links Kurawar –Bhopal and Indore - Kurawar is above 225 (approx.) kms then repeater shall be envisaged, otherwise line can be managed as a repeater less link.

TSP shall finalize the location of repeater station depending upon the actual site conditions Further TSP shall comply to the requirements mentioned as per Appendix-F.1

Maintenance of OPGW Cable, OPGW Hardware & repeater equipment & items associated with repeater shelter shall be responsibility of TSP.

OPGW on existing 765kV Bhopal (BDTCL) – Indore (PG) S/c line planned in separate scheme.

**C.5.0 Kurawar – Ashta 400 kV D/c (Quad ACSR/AAAC/AL59 moose equivalent) line.**

On Kurawar – Ashta 400 kV D/c (Quad ACSR/AAAC/AL59 moose equivalent) line, TSP shall supply, install and commission One (1) no. OPGW cable containing 24 Fibres (24F) on one E/W peak and conventional earth wire on other E/W peak.

The TSP shall install this OPGW from gantry of Kurawar up to the gantry of Ashta (MP) S/s with all associated hardware including Vibration Dampers, mid-way and gantry Joint Boxes (called **OPGW Hardware** hereafter) and finally terminate in Joint Boxes at end Substations. The transmission line length is **65 kms (approx.)** where repeater is not required to meet link budget requirement of Kurawar – Ashta (MP) link.

Maintenance of OPGW Cable and OPGW Hardware shall be responsibility of TSP.

**C.6.0 2 nos. of 400 kV line bays at Ashta (MP) S/s for termination of Kurawar – Ashta 400 kV D/c line.**

(I) TSP shall supply, install and commission one or more no. of FODP (120F or higher) alongwith panel and required Approach Cable (24F) with all associated hardware fittings from gantry tower to Bay Kiosk and from the Bay Kiosk to Control room.

(II) TSP shall supply, install and commission One STM-16 (FOTE) equipment alongwith panel/s supporting minimum five (5) directions with MSP (Multiplex Section Protection – 1+, excluding local patching 1) with necessary interfaces to meet the voice and data communication requirement among Ashta (MP).





Kurawar, Indore, Itarasi S/s. The suitable DC Power Supply and backup to be provided for communication equipment.

- (III) FOTE/FODP panel shall be installed in the new Bay Kiosk/ Switchyard Panel Room (SPR). The FOTE under present scope shall be integrated by TSP with the existing FOTE at control room of Ashta (MP) S/s which shall be communicating with respective control center. TSP to provide necessary FODP sub rack / Splice trays/ Patch cords etc. and optical interfaces/equipment in the existing FOTE/FODP panels in control room for integration with the existing FOTE for onwards data transmission.

In case spare optical direction is not available in the existing FOTE at the control room, the TSP shall coordinate with station owner to reconfigure the directions in existing FOTE at control room. Alternatively, The TSP may integrate the FOTE under the present scope with existing FOTE in the nearby Kiosk connected to the control room FOTE (if available with spare direction). For this purpose, TSP shall provide necessary FODP sub rack / Splice trays/ Patch cords etc. and suitable optical interfaces/ equipment in the existing FOTE/FODP panels in another Kiosk (SPR).

- (IV) FOTE and FODP can be accommodated in same panel to optimize space.
- (V) The new communication equipment under the present scope shall be compatible for integration with existing regional level centralized Network Management System (NMS). The local configuration of the new communication equipment shall be the responsibility of TSP. The configuration work in the existing centralized NMS for integration of new Communication equipment shall be done by Regional ULDC Team, however all the necessary support in this regard shall be ensured by TSP.
- (VI) The maintenance of all the communication equipment and software thereof including FOTE, PMU, FODP, approach cable, DCPS alongwith Battery Bank shall be the responsibility of TSP.

#### C.7.0 LILO of one circuit of Indore – Itarsi 400 kV D/ c line at Ashta.

On LILO of Indore – Itarsi 400 kV D/c line at Ashta (MP), TSP shall supply, install and commission OPGW and earthwire as per Tower Configurations:

- (i) For Multi Circuit Tower Configuration: Two (2) no. OPGW cable containing 24 Fibres (24F) to be installed and commissioned by the TSP on both the Earthwire peaks
- (ii) For Double Circuit Tower configuration (for both Loop In and Loop Out portion): One (1) no. OPGW cable containing 24 Fibres (24 F) on one earthwire peak and conventional earthwire on other E/W peak for both Loop In and Loop Out Lines.



The TSP shall install OPGW cables from gantry of Ashta (MP) S/s up to the LILO tower with all associated hardware including Vibration Dampers, mid-way and gantry Joint Boxes (called OPGW Hardware hereafter) and finally terminate in Joint Boxes at Ashta (MP) S/s. The transmission line length is **30 kms (approx.)** After LILO, if fiber length for links Indore – Ashta (MP) and Ashta (MP) - Itarasi is above 225 kms then repeater shall be envisaged, otherwise line can be managed as a repeater less link.

TSP shall finalize the location of repeater station depending upon the actual site conditions. Further TSP shall comply to the requirements mentioned as per **Appendix-F.1**

Maintenance of OPGW Cable, OPGW Hardware and repeater equipment and items associated with repeater shelter shall be responsibility of TSP.

**C.8.0 2 nos. of 400 kV line bays at Ashta (MP) S/s for LILO of one circuit of Indore – Itarsi 400 kV D/c line at Ashta.**

- I. TSP shall supply, install and commission Approach Cable (24F) with all associated hardware fittings from gantry tower to Bay Kiosk.
- II. MSP (Multiplex Section Protection – 1+1) direction for LILO of one circuit of Indore – Itarsi 400 kV D/c line at Ashta S/s has been considered in the scope of “2 nos. of 400 kV line bays at Ashta (MP) S/s for termination of Kurawar – Ashta 400 kV D/c line” as mentioned above at point no 6.

**C.9.0 Shujalpur – Kurawar 400 kV D/c (Quad ACSR/ AAAC/AL59 moose equivalent) line.**

On Shujalpur – Kurawar 400 kV D/c (Quad ACSR/ AAAC/AL59 moose equivalent) line, TSP shall supply, install and commission One (1) no. OPGW cable containing 24 Fibres (24F) on one E/W peak and conventional earth wire on other E/W peak. The TSP shall install this OPGW from gantry of Shujalpur (PG) S/s up to the gantry of Kurawar S/s with all associated hardware including Vibration Dampers, mid-way and gantry Joint Boxes (called **OPGW Hardware** hereafter) and finally terminate in Joint Boxes at end Substations. The transmission line length is **40 kms (approx.)**, where repeater is not required to meet link budget requirement of Shujalpur (PG) – Kurawar link.

Maintenance of OPGW Cable and OPGW Hardware shall be responsibility of TSP

**C.10.0 2 nos. of 400 kV line bays at Shujalpur (PG) S/s for termination of Shujalpur – Kurawar 400 kV D/c line.**

- (I) TSP shall supply, install and commission 1 no. **FODP (72F or higher)** alongwith panel and required Approach Cable (24F) with all associated hardware fittings from gantry tower to Bay Kiosk and from the Bay Kiosk to Control room.

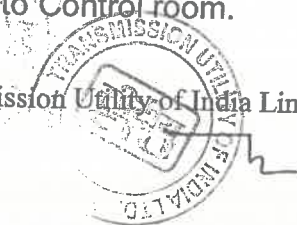

184



- (II) TSP shall supply, install and commission One STM-16 (FOTE) equipment alongwith panel/s supporting minimum three (3) directions with MSP (Multiplex Section Protection – 1+1, excluding local patching) with necessary interfaces to meet the voice and data communication requirement between Shujalpur (PG), Kurawar S/s. The suitable DC Power Supply and backup to be provided for communication equipment.
- (III) FOTE/FODP panel shall be installed in the new Bay Kiosk /Switchyard Panel Room (SPR). The FOTE under present scope shall be integrated by TSP with the existing FOTE at control room of Shujalpur (PG) S/s which shall be communicating with respective control center. TSP to provide necessary FODP sub rack / Splice trays/ Patch cords etc. and optical interfaces/equipment in the existing FOTE/FODP panels in control room for integration with the existing FOTE for onwards data transmission.
- In case spare optical direction is not available in the existing FOTE at the control room, the TSP shall coordinate with station owner to reconfigure the directions in existing FOTE at control room. Alternatively, The TSP may integrate the FOTE under the present scope with existing FOTE in the nearby Kiosk connected to the control room FOTE (if available with spare direction). For this purpose, TSP shall provide necessary FODP sub rack / Splice trays/ Patch cords etc. and suitable optical interfaces/ equipment in the existing FOTE/FODP panels in another Kiosk (SPR).
- (IV) FOTE and FODP can be accommodated in same panel to optimize space.
- (V) The new communication equipment under the present scope shall be compatible for integration with existing regional level centralized Network Management System (NMS). The local configuration of the new communication equipment shall be the responsibility of TSP. The configuration work in the existing centralized NMS for integration of new Communication equipment shall be done by Regional ULDC Team, however all the necessary support in this regard shall be ensured by TSP.
- (VI) The maintenance of all the communication equipment and software thereof including FOTE, PMU, FODP, approach cable, DCPS alongwith Battery Bank shall be the responsibility of TSP.

#### C.11.0 Specific Requirement for Phasor Measurement Units (PMUs)

TSP shall supply, install and commission required no. of Phasor Measurement Units (PMUs) at all the locations under the scope of TSP under this RFP as per CEA (Technical Standards for Construction of Electrical Plants and Electric Lines) Regulations, 2022 (alongwith all amendments if any), and all the applicable Regulations, Standards, Guidelines issued time to time. These PMUs shall be provided with GPS clock and LAN switch and shall connect with LAN switch of control room of respective substations/ generating stations with Fibre Optic cable. These PMUs shall be connected with the FOTE at Substation/ generating stations



for onwards data transmission to the PDC (Phasor Data Concentrator) located at respective RLDC. Configuration work in existing PDC at RLDC for new PMU integration shall be done by respective RLDC, however all the necessary support in this regard shall be ensured by TSP. The maintenance of all the PMUs and associated equipment shall be the responsibility of TSP.

Note: Existing Station owner/s to provide necessary support to integrate different equipment and applications of new extended bays with the existing substation e.g. Communication (through FOTE), Voice etc. for smooth operation and monitoring of new added grid elements.



186



## Appendix-F.1

## Repeater Requirements

- If the repeater location is finalized in the Control Room of a nearby substation, TSP shall provide 1 no. OPGW (48F) on a single Earthwire peak with OPGW Hardware & mid-way Joint Boxes etc. of the line crossing the main line and 1 no. Approach Cable (48F) with all associated hardware fittings, to establish connectivity between crossing point of main transmission line up to the repeater equipment in substation control room.  
TSP shall co-ordinate for Space and DC power supply sharing for repeater equipment.  
TSP shall provide FODP, FOTE (with STM-16 capacity) with suitable interfaces require for link budget of respective link.

OR

- If the repeater location is finalized in the nearby substation premises, the TSP shall identify the Space for repeater shelter in consultation with station owner. Further TSP shall provide 1 no. OPGW (48F) on a single Earthwire peak with OPGW Hardware and mid-way Joint Boxes etc. of the line crossing the main line and 1 no. Approach Cable (48F) / UGFO (48F) with all associated hardware fittings, to establish connectivity between crossing point of main transmission line up to the substation where the repeater shelter is to be housed.  
TSP shall provide repeater shelter along with FODP, FOTE (with STM-16 capacity) with suitable interfaces require for link budget of respective link, reliable power supply provisioning for AC and DC supply, battery bank, Air Conditioner and other associated systems.

OR

- If the repeater location is finalized on land near the transmission tower. TSP shall make the provisions for Land at nearby tower for repeater shelter. Further TSP shall provide 1 no. Approach Cable (48F) / UGFO (48F) with all associated hardware fittings to establish connectivity up to the location of repeater shelter.  
TSP shall provide repeater shelter along with FODP, FOTE (with STM-16 capacity) with suitable interfaces require for link budget of respective link, reliable power supply provisioning for AC and DC supply, battery bank, Air Conditioner and other associated systems

Maintenance of OPGW Cable and **OPGW Hardware**, repeater equipment and items associated with repeater shelter shall be responsibility of TSP.



187

Proposed Communication for Transmission system for evacuation of power from Rajasthan REZ Ph-IV (Part-2: 5.5 GW)  
(Jaisalmer/Barmer Complex): Part H1

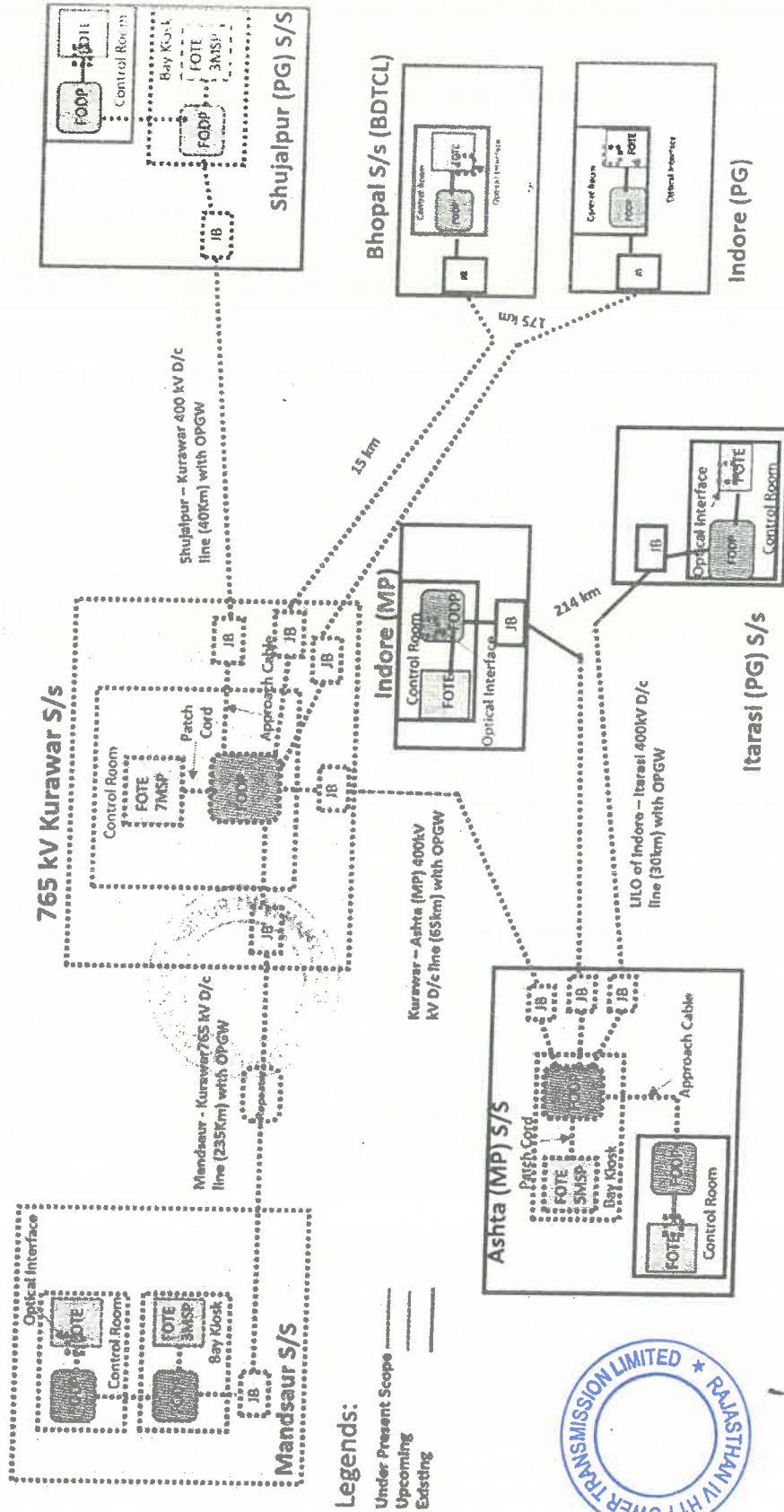

Figure F.1

*[Handwritten signature]*



188

**Next Generation Firewall (NGFW)**

TSP shall provide 2 NGFW one in Main and another in Standby mode having electrical ethernet interfaces/ports and placed between FOTE and SAS gateway/s at the substation. All ethernet based applications shall be terminated in the firewall ports directly (e.g. PMU, AMR, VOIP, SAS/SCADA etc.). Each port of firewall shall work as a separate zone. Firewall shall be hardware based with features of Block/Allow/drop and IPsec VPN (network encryption).

The number of ports/interfaces in each firewall (i.e. Main and Standby) shall be minimum 16 nos. TSP shall provide either single firewall or multiple firewalls to meet this interfaces requirement, each for main as well as standby firewall. Minimum throughput of firewall shall be 300 Mbps.

The Firewall shall be managed/ configured as standalone at present and shall also have compatibility to manage/configure through Centralized Management Console (CMC) remotely in future.

Firewall shall be tested and certified for ISO15408 Common Criteria for least EAL4+. Further, the OEM must certify that it conforms to Secure Product Development Life Cycle requirements as per IEC62443-4-1. The firewall shall generate reports for NERC-CIP Compliance.

The specifications for the firewalls are given at **Annexure-F.2** and schematic diagram showing firewall placement given at **Figure F.2**.



*[Handwritten signature]*



189

**Specifications of Next Generation Firewall (NGFW)**

1. NGFW shall have following features including but not limited to:  
Encryption through IPsec VPN (Virtual Private Network), Deep Packet Inspection (DPI), Denial of service (DoS) and Distributed Denial of Service (DDoS) prevention, Port Block/ Allow, rules/ policies for block/allow, IP (Internet Protocol) and Media Access Control (MAC) spoofing protection, threat detection, Intrusion Prevention System (IPS), Anti-Virus, Anti-Spyware, Man In The Middle (MITM) attack prevention.
2. The proposed firewall shall be able to handle (alert, block or allow) unknown /unidentified applications e.g. unknown TCP and UDP packets. It shall have the provision to define application control list based on application group and/or list.
3. Firewall shall have feature and also have capability to update the definition/ Signatures of Anti-Virus online as well as offline. Firewall shall also be compatible to update the definitions/signatures through CMC. There shall be a defined process for security patching and firmware up-gradation. There shall be a feature to field validate firmware checksum. The same shall also be validated before using the OEM provided file/binary in the process of firmware up-gradation and security patching.
4. Firewall shall have Management Console port to configure remotely.
5. Firewall shall be EMI/EMC compliant in Substation environment as per IEC 61850-3.
6. Firewall shall be rack mounted in existing standard equipment cabinets.
7. Firewall shall have support of SCADA applications (IEC-60870-5-104), ICCP, PMU (IEEE C37.118), Sub-Station Automation System (IEC 61850), Ethernet and other substation environment protocols.
8. Client based Encryption/ VPN must support different Operating System platforms e.g. Windows, Linux and Mac.
9. The solution must have content and comprehensive file detection policies, blocking the files as function of their types, protocols and directions.
10. Firewall shall have logging facility as per standard logs/events format. Firewall shall have features to export the generated/stored logs/events in csv (Comma Separated Value) and also any other standard formats for offline usage, analysis and compliance. Firewall shall have suitable memory architecture and solution to store and be enable to export all logs/events for a period of last 90 days at any given time.
11. Firewall shall have features and be compatible with local as well as central authentication system (RADIUS, LDAP, or TACACS+) for user account and access right management. It shall also have Role Based User management feature.
12. Firewall shall have the capability to configure sufficient number of VLANs.
13. Firewall shall have the capability to support sufficient number of sessions.



190





14. Firewall shall have provision to configure multiple IP Sec VPNs, at least 100 nos., (one-to-many or many-to-one). Shall support redundant operation with a similar router after creation of all the IP Sec VPN. IPSec VPN shall support encryption protocols as AES128, AES256 and hashing algorithms as MD5 and SHA1. IPSec VPN throughput shall support at least 300 Mbps.
15. Firewall shall be capable of SNMP v3 for monitoring from Network Management system. It shall also have SNMPv3 encrypted authentication and access security.
16. Firewall shall support in Active/Passive or Active-Active mode with High Availability features like load balancing, failover for firewall and IPsec VPN without losing the session connectivity.
17. Firewall should have integrated traffic shaping (bandwidth, allocation, prioritisation, etc.) functionality.
18. Shall support simultaneous operation with both IPv4 and IPv6 traffic .
19. Firewall shall be compatible with SNTP/NTP or any other standards for clock synchronization.
20. Firewall shall have the features of port as well as MAC based security
21. Firewall shall support exporting of logs to a centralized log management system (e.g. syslog) for security event and information management.
22. Firewall time shall be kept synchronised to official Indian Timekeeping agency, time.nplindia.org.
23. Firewall product shall be provided with all applicable updates at least until 36 months since the applicable date of product shipping to the concerned utility.



### Firewall Placement Diagram

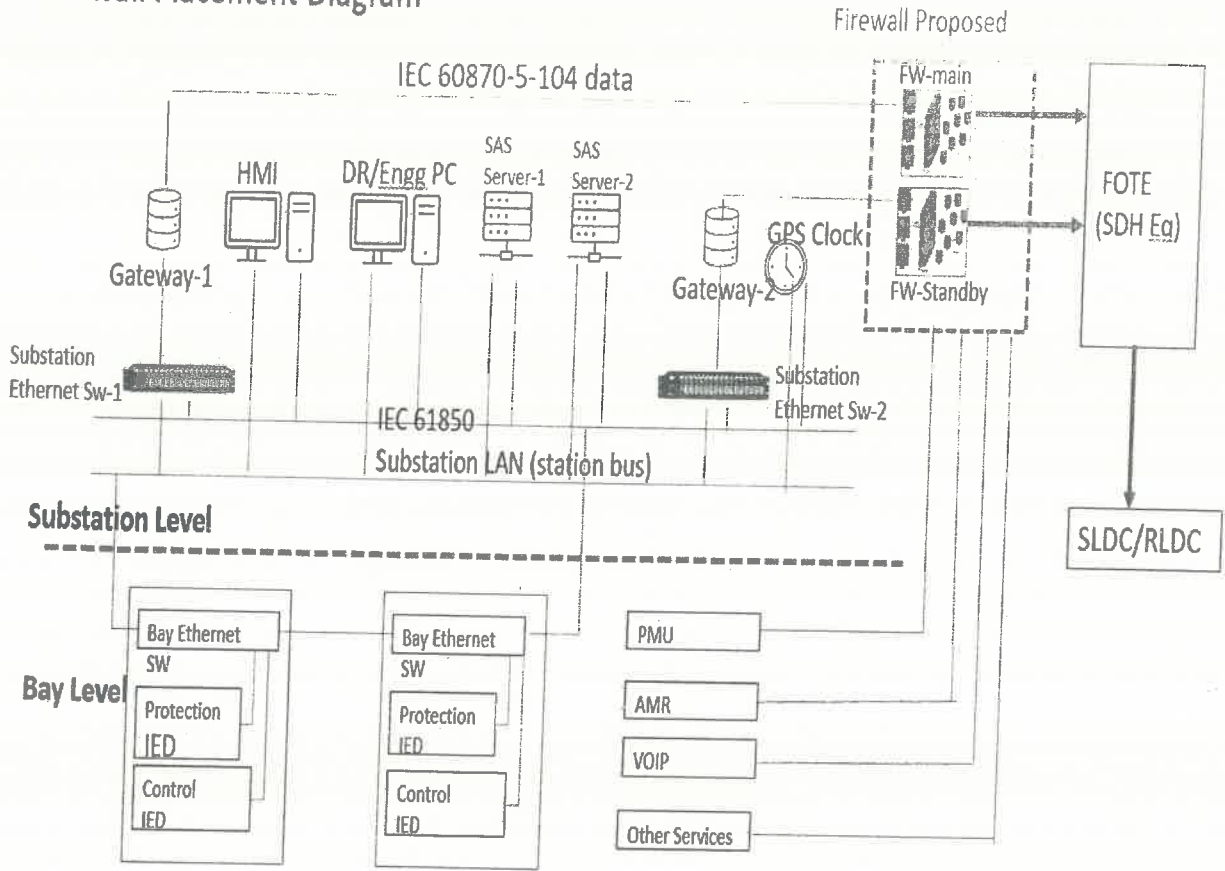

Figure F.2



192

**C.12.0 PLCC and PABX:**

Power line carrier communication (PLCC) equipment complete for speech, tele-protection commands and data channels shall be provided on each transmission line. The PLCC equipment shall in brief include the following: -

- Coupling device, Coupling filters line traps, carrier terminals, protection couplers; HF cables, PABX (if applicable) and maintenance and testing instruments.
- At new substation, a telephone exchange (PABX) of 24 lines shall be provided at as means of effective communication among various buildings of the substation, remote end substations and with control centres (RLDC/SLDC) etc.
- Coupling devices shall be suitable for phase-to-phase coupling for 400kV Transmission lines. The pass band of coupling devices shall have sufficient margin for adding communication channel in future if required. Necessary protection devices for safety of personnel and low voltage part against power frequency voltages and transient over voltage shall also be provided.
- The line traps shall be broad band tuned suitable for blocking the complete range of carrier frequencies. Line Trap shall have necessary protective devices such as lightning arresters for the protection of tuning device. Decoupling network consisting of line traps and coupling capacitors may also be required at certain substation in case of extreme frequency congestion.
- The carrier terminals shall be of single side-band (SSB) amplitude modulation (AM) type and shall have 4 kHz band width. PLCC Carrier terminals and Protection couplers shall be considered for both ends of the line.
- PLCC equipment for all the transmission lines covered under the scheme shall be provided by TSP. PLCC to be provided for following lines under present scope:

Sl. No	Line name	PLCC configuration
1	Mandsaur – Kurawar 765 kV D/c line	1 set Analog PLCC + 1 set Digital Protection Coupler for each circuit at both ends.
2	Kurawar – Ashta 400 kV D/c line	1 set Analog PLCC + 1 set Digital Protection Coupler for each circuit at both ends.
3	Shujalpur – Kurawar 400 kV D/c line	1 set Analog PLCC + 1 set Digital Protection Coupler for each circuit at both ends.

Further, CVT & Wave trap for all 765kV and 400kV line, bays under present scope shall be provided by TSP.



- TSP shall provide/ undertake necessary addition/ modification/ shifting/ re-commissioning etc. of PLCC equipment due to LILO of transmission lines (wherever applicable).

Sl. No	Line name	PLCC configuration
1.(a)	Indore – Kurawar 765 kV line [formed after LILO]	1 set Analog PLCC + 1 set Digital Protection Coupler at each end after LILO. Existing PLCC panels may also be utilized.
1.(b)	Bhopal – Kurawar 765 kV line [formed after LILO]	1 set Analog PLCC + 1 set Digital Protection Coupler at each end after LILO. Existing PLCC panels may also be utilized.
2.(a)	Indore – Ashta 400 kV line [formed after LILO]	1 set Analog PLCC + 1 set Digital Protection Coupler at each end after LILO. Existing PLCC panels may also be utilized.
2.(b)	Itarsi - Ashta 400 kV line [formed after LILO]	1 set Analog PLCC + 1 set Digital Protection Coupler at each end after LILO. Existing PLCC panels may also be utilized.

- All other associated equipment like cabling, coupling device and HF cable shall also be provided by the TSP.
- 2 sets of 48 V battery banks for PLCC and communication equipment shall be provided at each new Substation with at least 10-hour battery backup and extended backup, if required.





Frequently Asked Queries:1.0 Transmission Line:

- 1.1 Please clarify that whether shutdowns for crossing of existing transmission lines of POWERGRID/STUs/ Power Evacuation Lines from Generation Plants/ Any other Transmission Licensee will be given to TSP on chargeable basis or free of cost.

**Reply:** Shutdowns for crossing of existing transmission lines of POWERGRID/ STUs/ Power Evacuation Lines from Generation Plants/ Any other Transmission Licensee will be given to TSP by the concerned owner of the lines as per their own terms and conditions. As far as shutdown of ISTS lines are concerned the same can be availed by approaching respective Regional Power Committee.

- 1.2 We understand that the suggested swing angle criteria are applicable for Suspension Insulator in Suspension Tower. Further, you are requested to provide similar swing angle and clearance criteria for Pilot Insulator with Jumper and Jumper.

**Reply:** It is clarified that the swing angle criteria (as mentioned in RFP) for transmission lines is applicable for Suspension Insulator in Suspension Tower. Further, as per Clause 3.0 of Specific Technical Requirements for transmission lines, Transmission service Provider (TSP) shall adopt any additional loading/design criteria for ensuring reliability of the line, if so desired and /or deemed necessary.

- 1.3 We request you to kindly allow that use of diamond configuration at Power line crossings and the existing owner of the lines may be directed to allow the same for the successful bidders.

**Reply:** Power line crossing including Diamond configuration is responsibility of the TSP. TSP shall formally submit the profile of the crossing section to the owner of the existing line suggesting proposed crossing alternatives. The crossing will have to be carried out as per approval of owner of the existing line.

- 1.4 It is requested you to kindly provide present status of Forest Clearances if any transmission line corridor area falling in wildlife forest / reserve forest/ mangroves.

**Reply:** Based on the preliminary route survey, the process of initiation of forest clearance for the forest stretches, if any, enroute the proposed line alignment will be initiated by way of writing letters to the concerned authority (ies). However, it may be noted that it will be the responsibility of TSP for obtaining forest clearance for the forest stretches as provided in the survey report and also for any forest area encountered during detailed survey.

2.0 Substation

2.1 We understand that space for storage of O&M spare shall be provided by existing owner within the station boundary without any cost. Kindly confirm.  
**Reply:** Space for storage of O&M spares shall be arranged by TSP on its own.

2.2 We presume that the O&M for the end Termination bays will be in the scope of the TSP and TSP shall not be liable for any payment towards O&M to the existing owner of the substation. Kindly confirm.

**Reply:** Operation and maintenance of the bays is solely responsibility of the TSP. TSP shall follow CEA's "Operation and Maintenance (O&M) guidelines and Standard Format for Memorandum of Understanding between New TSP and Existing TSP" issued by CEA vide its letter No. I/28514/2023 dated 22.06.2023. Copy of the guideline is available on CEA website at following link:  
[https://cea.nic.in/wp-content/uploads/pse\\_\\_\\_td/2023/06/om\\_guidelines.pdf](https://cea.nic.in/wp-content/uploads/pse___td/2023/06/om_guidelines.pdf)

2.3 With reference to subject scheme of existing sub-station, we assumed following scope of work:

- (a) We assumed internal road is available and need not to consider in the present scope of work.
- (b) Drainage is available and need not to consider in the present scope of work.
- (c) Cable trench extension in adjacent to Main cable trench only under present scope of work.
- (d) Levelled area being provided by developer for bay extension.

**Reply:** Regarding requirement of internal road, drainage, cable trench, leveling of the bay extension area, bidder is advised to visit site and acquaint themselves with the provisions/facilities available at substation.

2.4 Kindly provide the soil investigation report of soil parameters of existing substation.

**Reply:** Bidder is advised to visit the substation site and ascertain the requisite parameters.

2.5 Kindly confirm, energy accounting of aux. power consumption. Whether it will be on chargeable basis or part of transmission loss.

**Reply:** It will be on chargeable basis.

2.6 We understand that VMS requirement is for unmanned stations only. For Manned stations VMS is not compulsory.

**Reply:** VMS shall be provided in line with requirements of RfP document.

2.7 It is understood that Construction water and power shall be provided free of cost to TSP by respective substation owner for construction of new bays.

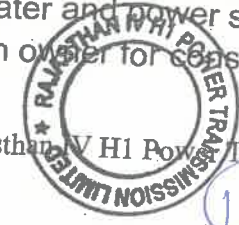
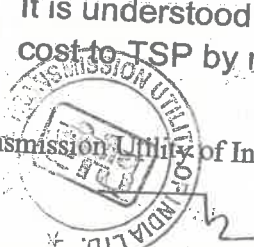

196

**Reply:** Arrangement of construction power & water is in the scope of TSP.

2.8 It is understood that existing fire hydrant system shall be extended by the TSP for bay extension.

**Reply:** Existing fire hydrant system shall be extended from existing system (if required)

2.9 Please clarify that Status of land acquisition for Substations. Whether the lands have been acquired by BPC and will be transferred to TSP.

**Reply:** The acquisition of land for substation is in the scope of TSP.

2.10 We understood that no any dedicated metering CT and CVT required for Line/feeders. Further, we understood that requisite Energy meters for various 765kV, 400kV and 220kV Feeders shall be provided and installed by CTU free of cost to TSP.

**Reply:** Dedicated metering CT and CVT are not required for line/feeders. Metering core of existing CT/CVT can be used provided accuracy class is matching with metering requirement. Requisite Special Energy Meters shall be provided and installed by CTU at the cost of TSP in C&P panel subject to space availability, else, in separate metering panel (to be provided by TSP at its cost).

2.11 It is understood that TSP to follow the RFP for Technical Requirement. Only interface drawings like CRP and SCADA shall be coordinated with existing S/S owner.

**Reply:** All necessary coordination shall be done with exiting s/s owner w.r.t interface along with augmentation required as per RfP.

2.12 We understand that there are only two communication channels, Chanel-1 for protection-1+ Speech via. PLCC, Chanel-2 for Protection-2 + data via. FOTE. Hence, we do not envisage any separate channel for speech + data as the same can be achieved with FOTE system. Therefore, we understand that TSP is allowed to implement best possible solutions accordingly. Kindly confirm

**Reply:** PLCC equipment for all the transmission lines covered under the scheme (consisting of one set of analog PLCC channel along with circuit protection coupler and one set of Digital protection coupler for both ends) shall be provided by TSP. Further, OPGW based terminal equipment shall be utilized for Speech+ Data.

2.13 We understand that one set of analog circuit protection coupler shall be for PLCC and another set for Digital protection coupler for FOTE. Kindly confirm.

**Reply:** PLCC equipment for all the transmission lines covered under the scheme (consisting of one set of analog PLCC channel along with circuit protection coupler and one set of Digital protection coupler for both ends) shall be

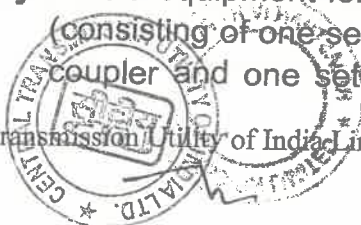

197





provided by TSP. Further, OPGW based terminal equipment shall be utilized for Speech+ Data.

**3.0 Communication**

3.1 What are the usage of OPGW, FOTE, PMU etc. under communication requirement of RFP?

**Reply:** User shall be responsible for providing compatible equipment along with appropriate interface for uninterrupted communication with the concerned control center and shall be responsible for successful integration with the communication system provided by CTU.

Communication systems e.g. OPGW, FOTE, PMU etc. are required for grid operation through RLDC/SLDC, speech communication, tele-protection and tele-metering.

3.2 Is space for installation of communication panels are provided to TSP in existing Substations incase new bays are in the scope of TSP?

**Reply:** The space replated issues are deliberated in the RFP itself. TSP to carry out survey of the existing substation for physical space requirement. In case space is not available in the existing substation then TSP shall accommodate the same in the respective bay SPR (Switchyard Panel Room)/Bay Kiosk/ Relay panel room in case of GIS s/s. Further, TSP to connect and integrate the proposed FOTE with the existing FOTE in the Relay Panel Room.

In Case 132kV Substation TSP shall accommodate the said panels either by extension of existing Relay Panel Room or other arrangements.

3.3 How is the OPGW laying done in case of LILO lines?

**Reply:** In case LILO lines are on same towers (e.g. both Line In and Line Out portion are on same towers, generally done LILO of S/C lines). Then 2x24F OPGW shall be required to install by TSP on both earthwire peak on 400kV and 765kV lines where two E/W peaks are available. On 220 and 133kV lines where only one E/W peak is available TSP to install one no. 48F OPGW.

Incase LILO lines are on different towers (e.g. both Line In and Line Out portion are on different towers, generally done LILO of D/C lines). Then 1x24F OPGW shall be required to install by TSP on one earthwire peak, on both Line In and Line Out portions of 400kV and 765kV lines. On 220 and 133kV lines where only one E/W peak is available TSP to install one no. 24F OPGW in place of conventional earthwire.

3.4 How is the OPGW laying done in case Multi circuit Towers?

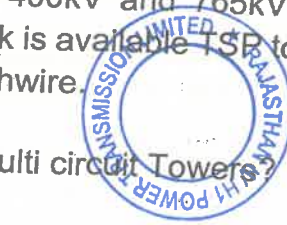



**Reply:** In case two different lines are using common multi circuit portion for some distance (originating from different stations, may be terminating on same or on different stations). Two no. 24F OPGW to be installed on both E/W peaks for common M/C portion of 765kV and 400kV lines.  
In case 220/132kV lines using multi circuit portion where single E/W peak is available one no. 48F may be installed for common multi circuit portion.



## Schedule: 2

## Scheduled COD

[Note: As referred to in the definition of "Element", "Scheduled COD", and in Articles 3.1.3 (c), 4.1 (b) and 4.3 (a) of this Agreement]

Sl. No.	Name of the Transmission Element	Scheduled COD from Effective Date	Percentage of Quoted Transmission Charges recoverable on Scheduled COD of the Element of the Project	Element(s) which are pre-required for declaring the commercial operation (COD) of the respective Element
1.	Establishment of 765/400 kV (2x1500 MVA), 400/22 kV (2x500 MVA) & 220/132 kV (3x200 MVA) Kurawar S/s with 2x330 MVAR 765 kV bus reactor and 1x125 MVAR, 420 kV bus reactor.	24 months (15/10/2026)	21.25%	All elements of the scheme are required to be commissioned simultaneously as their utilization is dependent on each other.
2.	<ul style="list-style-type: none"> <li>Mandsaur – Kurawar 765 kV D/c line</li> <li>240 MVAR switchable line reactors on each ckt at both ends of Mandsaur – Kurawar 765 kV D/c line</li> <li>2 nos. of 765 kV line bays at Mandsaur S/s for termination of Mandsaur – Kurawar 765 kV D/c line</li> </ul>		54.20 %	
3.	LILO of Indore – Bhopal 765 kV S/c line at Kurawar		4.88 %	
4.	<ul style="list-style-type: none"> <li>Kurawar – Ashta 400 kV D/c (Quad ACSR/AAAC/AL59 moose equivalent) line</li> <li>2 nos. of 400 kV line bays at Ashta (MP) S/s for</li> </ul>		7.57 %	



200

Sl. No.	Name of the Transmission Element	Scheduled COD from Effective Date	Percentage of Quoted Transmission Charges recoverable on Scheduled COD of the Element of the Project	Element(s) which are pre-required for declaring the commercial operation (COD) of the respective Element
	termination of Kurawar – Ashta 400 kV D/c line			
5.	<ul style="list-style-type: none"> <li>• LILO of one circuit of Indore – Itarsi 400 kV D/c line at Ashta</li> <li>• 2 nos. of 400 kV line bays at Ashta (MP) S/s for LILO of one circuit of Indore – Itarsi 400 kV D/c line at Ashta</li> </ul>		7.74 %	
6.	<ul style="list-style-type: none"> <li>• Shujalpur – Kurawar 400 kV D/c (Quad ACSR/AAAC/AL59 moose equivalent) line</li> <li>• 2 nos. of 400 kV line bays at Shujalpur(PG) S/s for termination of Shujalpur – Kurawar 400 kV D/c line</li> </ul>		4.36 %	

The TSP shall implement Part H1 in matching timeframe of Parts A, B, C, D, E, F of Rajasthan REZ Ph-IV (Part-2: 5.5 GW) (Jaisalmer/Barmer Complex) on best effort basis.

The payment of Transmission Charges for any Element, irrespective of its successful commissioning on or before its Scheduled COD, shall only be considered after successful commissioning of the Element(s), which are pre-required for declaring the commercial operation of such Element as mentioned in the above table.

Scheduled COD for the Project is: 24 months(15/10/2026)

**[Note: List of Element(s) along with the critical Element(s) to be provided by CEA]**

Central Transmission Utility of India Limited 128 Rajasthan IV H1 Power Transmission Limited



20/



### Schedule: 3

## Safety Rules and Procedures

[Note: As referred to in Articles 5.6 of this Agreement]

**1: Site Regulations and Safety:**

The TSP shall establish Site regulations within sixty (60) days from fulfilment of conditions subsequent, as per Prudent Utility Practices setting out the rules to be observed till expiry of the Agreement at the Site and shall comply therewith.

Such Site regulations shall include, but shall not be limited to, rules in respect of security, safety of the Project, gate control, sanitation, medical care, and fire prevention, public health, environment protection, security of public life, etc.

Copies of such Site regulations shall be provided to the Nodal Agency and the CEA for the purpose of monitoring of the Project.

**2: Emergency Work:**

In cases of any emergency, the TSP shall carry out all necessary remedial work as may be necessary.

If the work done or caused to be done by any entity, other than the TSP, the TSP shall, reimburse the actual costs incurred, to the other Party carrying out such remedial works.

**3: Site Clearance:**

In the course of execution of the Agreement, the TSP shall keep the Site reasonably free from all unnecessary obstruction, storage, remove any surplus materials, clear away any wreckage, rubbish and temporary works from the Site, and remove any equipment no longer required for execution of the Agreement. After completion of all Elements of the Project, the TSP shall clear away and remove all wreckage, rubbish and debris of any kind from the Site, and shall leave the Site clean and safe.

**4: Watching and Lighting:**

The TSP shall provide and maintain at its own expense all lighting, fencing, and watching when and where necessary for the proper construction, operation, maintenance / repair of any of the Elements of the Project, or for the safety of the owners and occupiers of adjacent property and for the safety of the public, during such maintenance / repair



202



**Schedule: 4****Computation of Transmission Charges****1.1 General**

The Monthly Transmission Charges to be paid to the TSP for providing Transmission Service for any Contract Year during the term of the Agreement shall be computed in accordance with this Schedule and paid as per Sharing Regulations.

Illustration regarding payment of Transmission Charges under various scenarios (considering definitions of Contract Year, Expiry Date & Monthly Transmission Charges above) is as below: -

**Illustration-1: In case the Project Elements achieve COD as per Schedule**

Quoted Transmission Charges: **Rs. 140 Million**

Completion Schedule:

Element No.	Completion Schedule in Months	Scheduled CoD of the Element	Actual CoD of the Element	% Charges recoverable on Scheduled CoD of the Element
Element 1	28	1-Feb-2018	1-Feb-2018	25%
Element 2	38	1-Dec-2018	1-Dec-2018	75%

Tariff Payable as follows:

Transmission Charges for Element 1			Transmission Charges for Element 2		
1-Feb-18 to 31-Mar-18	$140 \times 25\% \times ((28+31)/365)$	5.65		--	0.00
1-Apr-18 to 30-Nov-18	$140 \times 25\% \times (244/365)$	23.39		--	0.00
1-Dec-18 to 31-Mar-19	$140 \times 100\% \times (121/365)$				46.41
2	$140 \times 100\% \times 1$				140
3	$140 \times 100\% \times 1$				140
4	$140 \times 100\% \times 1$				140
5	$140 \times 100\% \times 1$				140
.....					
.....					
36 (1-Apr to 30-Nov)	$140 \times 100\% \times (244/365)$				93.59



203

**Illustration-2: In case of extension of Scheduled COD as per Article 4.4.1 & 4.4.2 of this Agreement**Quoted Transmission Charges: **Rs. 140 Million**

Completion Schedule:

Element No.	Completion Schedule in Months	Scheduled CoD of the Element	Actual CoD of the Element	% Charges recoverable on Scheduled CoD of the Element
Element 1	20	1-Feb-2018	1-Jul-2018	25%
Element 2	28	1-Oct-2018	1-Dec-2018	75%

Tariff Payable as follows:

Transmission Charges for Element 1			Transmission Charges for Element 2		
1-Feb-18 to 31-Mar-18	--	0.00		--	0.00
1-Apr-18 to 30-Jun-18	--	0.00		--	0.00
1-Jul-18 to 30-Nov-18	140 X 25% X (153/365)	14.67		--	0.00
1-Dec-18 to 31-Mar-19	140 X 100% X (121/365)				46.41
2	140 X 100% X 1				140
3	140 X 100% X 1				140
4	140 X 100% X 1				140
5	140 X 100% X 1				140
.....					
.....					
36 (1-Apr to 30-Nov)	140 X 100% X (244/365)				93.59



209

**Illustration-3: In case of delay in achieving COD of Project & all individual Elements (COD of the Project achieved in Contract Year 1)**Quoted Transmission Charges: **Rs. 140 Million**

Completion Schedule:

Element No.	Completion Schedule in Months	Scheduled CoD of the Element	Actual CoD of the Element	% Charges recoverable on Scheduled CoD of the Element
Element 1	20	1-Feb-2018	1-Dec-2018	25%
Element 2	28	1-Oct-2018	1-Dec-2018	75%

Tariff Payable as follows:

Transmission Charges for Element 1			Transmission Charges for Element 2		
1-Feb-18 to 31-Mar-18	--	0.00		--	0.00
1-Apr-18 to 30-Sept-18	--	0.00		--	0.00
1-Oct-18 to 30-Nov-18	--	0.00	1-Oct-18 to 30-Nov-18	--	0.00
1-Dec-18 to 31-Mar-19	140 X 100% X (121/365)				46.41
2	140 X 100% X 1				140
3	140 X 100% X 1				140
4	140 X 100% X 1				140
5	140 X 100% X 1				140
.....					
.....					
36 (1-Apr to 30-Nov)	140 X 100% X (244/365)				93.59



**Illustration-4: In case of delay in achieving COD of Project & all individual Elements (COD of the Project achieved in Contract Year other than Contract Year 1)**Quoted Transmission Charges: **Rs. 140 Million**

Completion Schedule:

Element No.	Completion Schedule in Months	Scheduled CoD of the Element	Actual CoD of the Element	% Charges recoverable on Scheduled CoD of the Element
Element 1	38	1-Oct-2019	1-May-2020	25%
Element 2	38	1-Oct-2019	1-May-2020	75%

Tariff Payment to be paid as:

Transmission Charges for Element 1			Transmission Charges for Element 2		
1-Oct-19 to 31-Mar-20	--	0.00	1-Oct-19 to 31-Mar-20	--	0.00
1-Apr-20 to 30-Apr-20	-	0.00	1-Apr-20 to 30-Apr-20	-	0.00
1-May-20 to 31-Mar-21	140 X 100% X (335/365)				128.49
2	140 X 100% X 1				140
3	140 X 100% X 1				140
4	140 X 100% X 1				140
5	140 X 100% X 1				140
.....					
.....					
36 (1-Apr to 30-Apr)	140 X 100% X (30/ 365)				11.51



206



**Illustration 5: In case of delay in achieving COD of Element but Project COD achieved on time**Quoted Transmission Charges: **Rs. 140 Million**

Completion Schedule:

Element No.	Completion Schedule in Months	Scheduled CoD of the Element	Actual CoD of the Element	% Charges recoverable on Scheduled CoD of the Element
Element 1	20	1-Feb-2018	1-Jul-2018	25%
Element 2	30	1-Dec-2018	1-Dec-2018	75%

Tariff Payable as follows:

Transmission Charges for Element 1			Transmission Charges for Element 2		
1-Feb-18 to 31-Mar-18	--	0.00		--	0.00
1-Apr-18 to 30-Jun-18	--	0.00		--	0.00
1-Jul-18 to 30-Nov-18	140 X 25% X (153/365)	14.67		--	0.00
1-Dec-18 to 31-Mar-19	140 X 100% X (121/365)				46.41
2	140 X 100% X 1				140
3	140 X 100% X 1				140
4	140 X 100% X 1				140
5	140 X 100% X 1				140
.....					
.....					
36 (1-Apr to 30-Nov)	140 X 100% X (244/365)				93.59



**Illustration-6: In case of early commissioning of Project**  
 Quoted Transmission Charges: Rs. 140 Million

Completion Schedule:

Element No.	Completion Schedule in Months	Scheduled CoD of the Element	Actual CoD of the Element	% Charges recoverable on Scheduled CoD of the Element
Element 1	38	1-Oct-2019	1-Jul-2019	25%
Element 2	38	1-Oct-2019	1-Jul-2019	75%

Tariff Payment to be paid as:

Transmission Charges for Element 1		Transmission Charges for Element 2	
1-July-19 to 31-Mar-20	140 X 100% X (274/365)		105.09
2	140 X 100% X 1		140
3	140 X 100% X 1		140
4	140 X 100% X 1		140
5	140 X 100% X 1		140
.....			
.....			
36 (1-Apr to 30-Jun)	140 X 100% X (91/365)		34.91



**Illustration-7: In case of early commissioning of an element**

Quoted Transmission Charges: **Rs. 140 Million**

Completion Schedule:

Element No.	Completion Schedule in Months	Scheduled CoD of the Element	Actual CoD of the Element	% Charges recoverable on Scheduled CoD of the Element
Element 1	38	1-Oct-2019	1-Apr-2019	25%
Element 2	38	1-Jul-2019	1-Jul-2019	75%

Tariff Payment to be paid as:

Transmission Charges for Element 1			Transmission Charges for Element 2		
1-Apr-2019 to 30-Jun-19	140 X 25% X (91/365)	8.72	1-Apr-2019 to 30-Jun-19	--	0.00
1-July-19 to 31-Mar-20	140 X 100% X (274/ 365)				105.09
2	140 X 100% X 1				140
3	140 X 100% X 1				140
4	140 X 100% X 1				140
5	140 X 100% X 1				140
.....					
.....					
36 (1-Apr-30-Jun)	140 X 100% X (91/365)				34.91

The Transmission Charges shall be payable on monthly basis as computed above.

**1.2 Computation of Monthly Transmission Charges**

The Monthly Transmission Charges for any month m in a Contract Year n shall be calculated as below:

For AC System:

- a. If Actual Transmission System Availability for the month m of contract year n is greater than or equal to 98% and less than or equal to 98.5%;

Monthly Transmission Charges MTC(m) =

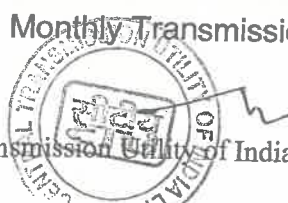

209

- b. If Actual Transmission System Availability for the month m of contract year n exceeds 98.5% and less than or equal to 99.75%;

$$\text{Monthly Transmission Charges MTC}(m) = T_{mn} * (AA / 98.5\%)$$

- c. If Actual Transmission System Availability for the month m of contract year n is greater than 99.75%;

$$\text{Monthly Transmission Charges MTC}(m) = T_{mn} * (99.75\% / 98.5\%)$$

- d. If Actual Transmission System Availability for the month m of contract year n is less than 98% and greater than or equal to 95.00%;

$$\text{Monthly Transmission Charges MTC}(m) = T_{mn} * (AA / 98\%)$$

- e. If Actual Transmission System Availability for the month m of contract year falls below 95%;

$$\text{Monthly Transmission Charges MTC}(m) = T_{mn} * (AA / 98\%) - 0.02 * (T_{mn} * (AA / 95\%))$$

For DC System:

- a. If Actual Transmission System Availability for the month m of contract year n is greater than or equal to 95% and less than or equal to 96%;

$$\text{Monthly Transmission Charges MTC}(m) = T_{mn} * 1$$

- b. If Actual Transmission System Availability for the month m of contract year n exceeds 96% and less than or equal to 99.75%;

$$\text{Monthly Transmission Charges MTC}(m) = T_{mn} * (AA / 96\%)$$

- c. If Actual Transmission System Availability for the month m of contract year n is greater than 99.75%;

$$\text{Monthly Transmission Charges MTC}(m) = T_{mn} * (99.75\% / 96\%)$$

- d. If Actual Transmission System Availability for the month m of contract year n is less than 95% and greater than or equal to 92.00%;

$$\text{Monthly Transmission Charges MTC}(m) = T_{mn} * (AA / 95\%)$$

- e. If Actual Transmission System Availability for the month m of contract year falls below 92%;



210



$$\text{Monthly Transmission Charges MTC}(m) = T_{mn} * (\text{AA} / 95\%) - 0.02 * (T_{mn} * (\text{AA} / 92\%))$$

where:

- AA is the actual Availability, as certified by RPC, as per procedure provided in Schedule 6.
- m is the month in Contract Year 'n'
- $T_{mn}$  = Transmission Charges for the month 'm' in Contract Year 'n' =  $(\text{Transmission Charge} / \text{no. of days in the Year } n) * \text{no. of days in month } m$

Provided, no Transmission Charges shall be paid during the period for which the RLDC has not allowed the operation of the Element/Project due to the failure of the TSP to operate it as per the provisions of the Grid Code.

### 1.3 RLDC Fee & Charges

The payment of RLDC fee & charges, in accordance with relevant regulations of CERC, shall be the responsibility of the TSP.



## Schedule: 5

## Quoted Transmission Charges

[Quoted Transmission Charges from Annexure - 21 of the RFP of the Selected Bidder to be inserted here]

[To be incorporated from the Bid of the Selected Bidder submitted during the e-reverse auction after its selection]

Quoted Transmission Charges: Rs. .... Million

Proportionate Transmission Charges payable for each Element of the Project:

Sl. No.	Name of the Transmission Element	Percentage of Quoted Transmission Charges recoverable on Scheduled COD of the Element of the Project	Element(s) which are pre-required for declaring the commercial operation (COD) of the respective Element
1.	Establishment of 765/400 kV (2x1500 MVA), 400/22 kV (2x500 MVA) & 220/132 kV (3x200 MVA) Kurawar S/s with 2x330 MVAR 765 kV bus reactor and 1x125 MVAR, 420 kV bus reactor.	21.25%	All elements of the scheme are required to be commissioned simultaneously as their utilization is dependent on each other.
2.	<ul style="list-style-type: none"> <li>Mandsaur – Kurawar 765 kV D/c line</li> <li>240 MVAR switchable line reactors on each ckt at both ends of Mandsaur – Kurawar 765 kV D/c line</li> <li>2 nos. of 765 kV line bays at Mandsaur S/s for termination of Mandsaur – Kurawar 765 kV D/c line</li> </ul>	54.20 %	
3.	LILO of Indore – Bhopal 765 kV S/c line at Kurawar	4.88 %	



212



Transmission Service Agreement

Sl. No.	Name of the Transmission Element	Percentage of Quoted Transmission Charges recoverable on Scheduled COD of the Element of the Project	Element(s) which are pre-required for declaring the commercial operation (COD) of the respective Element
4.	<ul style="list-style-type: none"> <li>• Kurawar – Ashta 400 kV D/c (Quad ACSR/AAAC/AL59 moose equivalent) line</li> <li>• 2 nos. of 400 kV line bays at Ashta (MP) S/s for termination of Kurawar – Ashta 400 kV D/c line</li> </ul>	7.57 %	
5.	<ul style="list-style-type: none"> <li>• LILO of one circuit of Indore – Itarsi 400 kV D/c line at Ashta</li> <li>• 2 nos. of 400 kV line bays at Ashta (MP) S/s for LILO of one circuit of Indore – Itarsi 400 kV D/c line at Ashta</li> </ul>	7.74 %	
6.	<ul style="list-style-type: none"> <li>• Shujalpur – Kurawar 400 kV D/c (Quad ACSR/AAAC/AL59 moose equivalent) line</li> <li>• 2 nos. of 400 kV line bays at Shujalpur(PG) S/s for termination of Shujalpur – Kurawar 400 kV D/c line</li> </ul>	4.36 %	

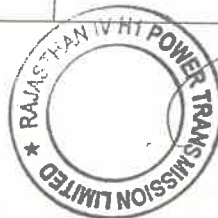

213

## Schedule: 6

### Appendix IV of the Central Electricity Regulatory Commission (Terms and Conditions of Tariff) Regulations 2024

#### Procedure for Calculation of Transmission System Availability Factor for a Month

1. Transmission system availability factor for nth calendar month ("TAFPn") shall be calculated by the respective transmission licensee, got verified by the concerned Regional Load Dispatch Centre (RLDC) and certified by the Member-Secretary, Regional Power Committee of the region concerned, separately for each AC and HVDC transmission system and grouped according to sharing of transmission charges. In case of AC system, transmission System Availability shall be calculated separately for each Regional Transmission System and inter-regional transmission system. In case of HVDC system, transmission System Availability shall be calculated on consolidate basis for all inter-state HVDC system.
2. Transmission system availability factor for nth calendar month ("TAFPn") shall be calculated by consider following:
  - i) **AC transmission lines:** Each circuit of AC transmission line shall be considered as one element;
  - ii) **Inter-Connecting Transformers (ICTs):** Each ICT bank (three single phase transformer together) shall form one element;
  - iii) **Static VAR Compensator (SVC):** SVC along with SVC transformer shall form one element;
  - iv) **Bus Reactors or Switchable line reactors:** Each Bus Reactors or Switchable line reactors shall be considered as one element;
  - v) **HVDC Bi-pole links:** Each pole of HVDC link along with associated equipment at both ends shall be considered as one element;
  - vi) **HVDC back-to-back station:** Each block of HVDC back-to-back station shall be considered as one element. If associated AC line (necessary for transfer of inter- regional power through HVDC back-to-back station) is not available, the HVDC back-to-back station block shall also be considered as unavailable;
  - vii) **Static Synchronous Compensation ("STATCOM"):** Each STATCOM shall be considered as separate element.
3. The Availability of AC and HVDC portion of Transmission system shall be calculated by considering each category of transmission elements as under:





TAFMn (in %) for AC system:

$$= \frac{o \times AV_o + (p \times AV_p) + (q \times AV_q) + (r \times AV_r) + (u \times AV_u)}{(o + p + q + r + u)} \times 100$$

Where,

- o = Total number of AC lines.
- AVo = Availability of o number of AC lines.
- p = Total number of bus reactors/switchable line reactors
- AVp = Availability of p number of bus reactors/switchable line reactors
- q = Total number of ICTs.
- AVq = Availability of q number of ICTs.
- r = Total number of SVCs.
- AVr = Availability of r number of SVCs
- u = Total number of STATCOM.
- AVu = Availability of u number of STATCOMs

TAFMn (in %) for HVDC System:

$$= \frac{\sum_{x=1}^s C_{xpb}(\text{act}) \times AV_{xpb} + \sum_{y=1}^t C_{ybtb}(\text{act}) \times AV_{ybtb}}{\sum_{x=1}^s C_{xpb} + \sum_{y=1}^t C_{ybtb}} \times 100$$

Where

- C<sub>xpb</sub>(act) = Total actual operated capacity of x<sup>th</sup> HVDC pole
- C<sub>xpb</sub> = Total rated capacity of x<sup>th</sup> HVDC pole



215

Transmission Service Agreement

- AV<sub>y</sub> = Availability of y<sup>th</sup> HVDC pole  
C<sub>kt</sub>t<sub>ba</sub>ct = Total actual operated capacity of t<sup>th</sup> HVDC back-to-back station block  
C<sub>y</sub>t<sub>bt</sub>b = Total rated capacity of y<sup>th</sup> HVDC back-to-back station block  
AV<sub>y</sub>t<sub>bt</sub>b = Availability of y<sup>th</sup> HVDC back-to-back station block  
s = Total no of HVDC poles  
t = Total no of HVDC Back to Back blocks

4. The availability for each category of transmission elements shall be calculated based on the weightage factor, total hours under consideration and non-available hours for each element of that category. The formulae for calculation of Availability of each category of the transmission elements are as per **Appendix-V**. The weightage factor for each category of transmission elements shall be considered as under:

- (a) For each circuit of AC line – Number of sub-conductors in the line multiplied by ckt-km;
- (b) For each HVDC pole- The rated MW capacity x ckt-km;
- (c) For each ICT bank – The rated MVA capacity;
- (d) For SVC- The rated MVAR capacity (inductive and capacitive);
- (e) For Bus Reactor/switchable line reactors – The rated MVAR capacity;
- (f) For HVDC back-to-back station connecting two Regional grids- Rated MW capacity of each block; and
- (g) For STATCOM – Total rated MVAR Capacity.

5. The transmission elements under outage due to following reasons shall be deemed to be available:

- i. Shut down availed for maintenance of another transmission scheme or construction of new element or renovation/upgradation/additional capitalization in existing system approved by the Commission. If the other transmission scheme belongs to the transmission licensee, the Member Secretary, RPC may restrict the deemed availability period to that considered reasonable by him for the work involved. In case of dispute regarding deemed availability, the matter may be referred to Chairperson, CEA within 30 days.
- ii. Switching off of a transmission line to restrict over voltage and manual tripping of switched reactors as per the directions of concerned RLDC.
- iii. Shut down of a transmission line due to the Project(s) of NHAI, Railways and Border Road Organization, including for shifting or modification of such transmission line or any other infrastructure project approved by Ministry of Power. Member Secretary, RPC may restrict the deemed availability period to that considered reasonable by him for the work involved; Provided that

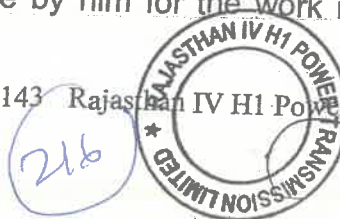
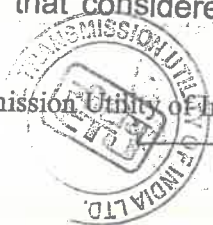

apart from the deemed availability, any other costs involved in the process of such shutdown of transmission line shall not be borne by the DICs.

Provided that such deemed availability shall be considered only for the period for which DICs are not affected by the shutdown of such transmission line.

6. For the following contingencies, outage period of transmission elements, as certified by the Member Secretary, RPC, shall be excluded from the total time of the element under period of consideration for the following contingencies:
- i) Outage of elements due to acts of God and force majeure events beyond the control of the transmission licensee. However, whether the same outage is due to force majeure (not design failure) will be verified by the Member Secretary, RPC. A reasonable restoration time for the element shall be considered by Member Secretary, RPC and any additional time taken by the transmission licensee for restoration of the element beyond the reasonable time shall be treated as outage time attributable to the transmission licensee. Member Secretary, RPC may consult the transmission licensee or any expert for estimation of reasonable restoration time. Circuits restored through ERS (Emergency Restoration System) shall be considered as available;
  - ii) Outage caused by grid incident/disturbance not attributable to the transmission licensee, e.g. faults in substation or bays owned by other agency causing outage of the transmission licensee's elements, and tripping of lines, ICTs, HVDC, etc. due to grid disturbance. However, if the element is not restored on receipt of direction from RLDC while normalizing the system following grid incident/disturbance within reasonable time, the element will be considered not available for the period of outage after issuance of RLDC's direction for restoration;
  - iii) The outage period which can be excluded for the purpose of sub-clause (i) and (ii) of this clause shall be declared as under:
    - a. Maximum up to one month by the Member Secretary, RPC;
    - b. Beyond one month and up to three months after the decision at RPC;
    - c. Beyond three months by the Commission for which the transmission license shall approach the Commission along with reasons and steps taken to mitigate the outage and restoration timeline.

7. Time frame for certification of transmission system availability: (1) Following schedule shall be followed for certification of availability by Member Secretary of concerned RPC:

- Submission of outage data by Transmission Licensees to RLDC/ constituents - By 5th of the following month;
- Review of the outage data by RLDC / constituents and forward the same to respective RPC - by 20th of the month;
- Issue of availability certificate by respective RPC - by 3rd of the next month.

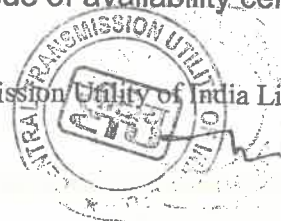

Appendix V

FORMULAE FOR CALCULATION OF AVAILABILITY OF EACH CATEGORY OF TRANSMISSION ELEMENTS

For AC transmission system

$$AV_0(\text{Availability of } o \text{ no. of AC lines}) = \frac{\sum_{i=1}^o W_i(T_i - TNA_i)/T_i}{\sum_{i=1}^o W_i}$$

$$AV_q(\text{Availability of } q \text{ no. of ICTs}) = \frac{\sum_{k=1}^q W_k(T_k - TNA_k)/T_k}{\sum_{k=1}^q W_k}$$

$$AV_r(\text{Availability of } r \text{ no. of SVCs}) = \frac{\sum_{i=1}^{r-1} W_i(T_i - TNA_i)/T_i}{\sum_{i=1}^r W_i}$$

$$AV_p(\text{Availability of } p \text{ no. of Switched Bus reactors}) = \frac{\sum_{m=1}^p W_m(T_m - TNA_m)/T_m}{\sum_{m=1}^p W_m}$$

$$AV_u(\text{Availability of } u \text{ no. of STATCOMs}) = \frac{\sum_{n=1}^u W_n(T_n - TNA_n)/T_n}{\sum_{n=1}^u W_n}$$

$$AV_{np}(\text{Availability of an individual HVDC pole}) = \frac{(T_x - TN)}{T_x}$$

$AV_{yts}$  (Availability of an individual HVDC

$$\text{Back-to-back Blocks}) = \frac{(T_y - TNA_y)}{T_y}$$



288



Transmission Service Agreement

For the HVDC transmission system

For the new HVDC commissioned but not completed twelve months.

For first 12 months:  $[(AV_{xtp} \text{ or } AV_{ytb}) \times 95\% / 85\%]$ , subject to a ceiling of 95%.

Where,

- $o$  = Total number of AC lines;
- $AV_o$  = Availability of  $o$  number of AC lines;
- $p$  = Total number of bus reactors/switchable line reactors;
- $AV_p$  = Availability of  $p$  number of bus reactors/switchable line reactors;
- $q$  = Total number of ICTs;
- $AV_q$  = Availability of  $q$  number of ICTs;
- $r$  = Total number of SVCs;
- $AV_r$  = Availability of  $r$  number of SVCs;
- $U$  = Total number of STATCOM;
- $AV_u$  = Availability of  $u$  number of STATCOMs;
- $W_i$  = Weightage factor for  $i$ th transmission line;
- $W_k$  = Weightage factor for  $k$ th ICT;
- $W_l$  = Weightage factors for inductive & capacitive operation of  $l$ th SVC;
- $W_m$  = Weightage factor for  $m$ th bus reactor;
- $W_n$  = Weightage factor for  $n$ th STATCOM.
- $T_i, T_k, T_l$  = The total hours of  $i$ th AC line,  $k$ th ICT,  $l$ th SVC,  $m$ th Switched Bus Reactor &  $n$ th STATCOM,  $x$ th HVDC pole,  $y$ th HVDC back-to-back blocks during the period under consideration (excluding time period for outages not attributed to transmission licensee for the reasons given in Para 5 of the procedure)
- $T_{NA}, T_{NAk}$  = The non-availability hours (excluding the time period for outages not attributed to transmission licensee taken as deemed availability as  $T_{NA}, T_{NAk}, T_{NAx}, T_{NAy}$  per Para 5 of the procedure) for  $i$ th AC line,  $k$ th ICT,  $l$ th SVC,  $m$ th Switched Bus Reactor,  $n$ th STATCOM,  $x$ th HVDC pole and  $y$ th HVDC back-to-back block.



219

**Schedule: 7**

**Entire Bid (both financial bid and technical bid) of the Selected Bidder to be attached here**



Central Transmission Utility of India Limited



147

Rajasthan IV H1 Power Transmission Limited



229

Schedule: 8

Contract Performance Guarantee

(To be on non-judicial stamp paper of appropriate value as per Stamp Act relevant to place of execution. Foreign entities submitting Bids are required to follow the applicable law in their country.)

In consideration of the .....[Insert name of the SPV or Selected Bidder on behalf of the TSP, or Lead Member in case of the Consortium, with address] agreeing to undertake the obligations under the Transmission Service Agreement dated .....and the other RFP Project Documents and the Nodal Agency and the .....[Insert the name of the BPC], agreeing to execute the *RFP Project Documents* with the Selected Bidder, regarding setting up the Project, the ..... [Insert name and address of the bank issuing the guarantee and address of the head office] (hereinafter referred to as "Guarantor Bank") hereby agrees unequivocally, irrevocably and unconditionally to pay to ..... (being the Nodal Agency) at .....[Insert the Place from the address of the Nodal Agency indicated in the TSA] forthwith on demand in writing from the Nodal Agency or any Officer authorized by it in this behalf, any amount up to and not exceeding Rupees ..... Crores (Rs. ....) only [Insert the amount of the bank guarantee] on behalf of M/s. .... [Insert name of the Selected Bidder or SPV]. This guarantee shall be valid and binding on the Guarantor Bank up to and including .....and shall not be terminable by notice or any change in the constitution of the Bank or the term of the Transmission Service Agreement or by any other reasons whatsoever and our liability hereunder shall not be impaired or discharged by any extension of time or variations or alternations made, given, or agreed with or without our knowledge or consent, by or between parties to the respective agreement.

Our liability under this Guarantee is restricted to Rs. .... Crores (Rs. ....) only. Our Guarantee shall remain in force until ..... [Insert the date of validity of the Guarantee as per Article 3.1.2 of this Agreement]. The Nodal Agency, shall be entitled to invoke this Guarantee up to three hundred sixty five (365) days of the last date of the validity of this Guarantee.

The Guarantor Bank hereby expressly agrees that it shall not require any proof in addition to the written demand from ..... (in its roles as the Nodal Agency), made in any format, raised at the above mentioned address of the Guarantor Bank, in order to make the said payment to Nodal Agency.



221

The Guarantor Bank shall make payment hereunder on first demand without restriction or conditions and notwithstanding any objection by ..... [Insert name of the Selected Bidder], ..... [Insert name of the TSP] and / or any other person. The Guarantor Bank shall not require Nodal Agency to justify the invocation of this BANK GUARANTEE, nor shall the Guarantor Bank have any recourse against Nodal Agency in respect of any payment made hereunder.

**THIS BANK GUARANTEE** shall be interpreted in accordance with the laws of India. The Guarantor Bank represents that this BANK GUARANTEE has been established in such form and with such content that it is fully enforceable in accordance with its terms as against the Guarantor Bank in the manner provided herein.

**THIS BANK GUARANTEE** shall not be affected in any manner by reason of merger, amalgamation, restructuring, liquidation, winding up, dissolution or any other change in the constitution of the Guarantor Bank.

**THIS BANK GUARANTEE** shall be a primary obligation of the Guarantor Bank and accordingly Nodal Agency shall not be obliged before enforcing this BANK GUARANTEE to take any action in any court or arbitral proceedings against ..... [Insert name of the SPV] or the Selected Bidder, as the case may be, to make any claim against or any demand on ..... [Insert name of the SPV] or the Selected Bidder, as the case may be, or to give any notice to ..... [Insert name of the SPV] or the Selected Bidder, as the case may be, or to enforce any security held by the Nodal Agency or to exercise, levy or enforce any distress, diligence or other process against ..... [Insert name of the SPV] or the Selected Bidder, as the case may be.

The Guarantor Bank acknowledges that this BANK GUARANTEE is not personal to Nodal Agency and may be assigned, in whole or in part, (whether absolutely or by way of security) by Nodal Agency to any entity to whom the Nodal Agency is entitled to assign its rights and obligations under the Transmission Service Agreement.

The Guarantor Bank hereby agrees and acknowledges that Nodal Agency shall have a right to invoke this Bank Guarantee either in part or in full, as it may deem fit.

Notwithstanding anything contained hereinabove, our liability under this Guarantee is restricted to Rs. .... Crores (Rs. ....) only and it shall remain in force until ..... [Date to be inserted on the basis of Article 3.1.2 of the Transmission Service Agreement], with an additional claim period of three hundred sixty five (365) days thereafter. This BANK GUARANTEE shall be extended from time to time for such period, as may be desired by ..... [Insert name of the Selected Bidder or Lead Member in case of the Consortium or SPV]. We are liable to pay the guaranteed



222





amount or any part thereof under this Bank Guarantee only if Nodal Agency serves upon us a written claim or demand.

**In witness where of:**

Signature .....

Name: .....

Power of attorney No.: .....

**For:**  
..... [Insert Name of the Bank]

**Banker's Seal and Full Address, including mailing address of the Head Office**



**Schedule: 9**

**Methodology for determining the Relief Under Force Majeure Event & Change in Law during Construction Period**

The relief in the form of revision in tariff due to Force Majeure Event leading to extension of Scheduled COD for a period beyond one hundred eighty (180) days and/ or Change in Law during the construction period shall be as under:

$$\Delta T = [(P \times d)] \div [1 - (1 + d)^{-n}]$$

Where,

$\Delta T$  = Change in Transmission Charges for each year

P = Sum of cumulative increase or decrease in the cost of the Project due to Change in Law and interest cost during construction corresponding to the period exceeding one hundred eighty (180) due to Force Majeure Event leading to extension of Scheduled COD for a period beyond one hundred eighty (180) days

n = number of years over which the Transmission Charges has to be paid

d = Discount rate as notified by the CERC, applicable on the Bid Deadline

The increase in Transmission Charges as stated above shall be applicable only if the value of increase in Transmission Charges as calculated above exceeds 0.30% (zero point three percent) of the quoted Transmission Charges of the TSP.



Central Transmission Utility of India Limited



151 Rajasthan IV H1 Power Transmission Limited

224

Ref No: RECPDCL/TBCB/Rajasthan IV H1/2023-24/3467

Date: 01.01.2024

**Mr. Pankaj Pandey, ED**  
**M/s Power Grid Corporation of India Limited,**  
'Saudamini', Plot no. 2, Sector – 29,  
Gurgaon – 122001 (Haryana).

**Subject: Selection of Bidder as Transmission Service Provider (TSP) to establish "Transmission System for Evacuation of Power from Rajasthan REZ Ph-IV (Part-2: 5.5 GW) (Jaisalmer/Barmer Complex): Part H1" to be implemented through Tariff Based Competitive Bidding process.**

Dear Sir,

This has reference to the RFP dated 08.11.2023 for selection of Transmission Service Provider to establish "Transmission System for Evacuation of Power from Rajasthan REZ Ph-IV (Part-2: 5.5 GW) (Jaisalmer/Barmer Complex): Part H1" (hereinafter referred to as "the Project") through tariff based competitive bidding process.

As per the requirement of Clause 1.5 of RFP, we would like to intimate you that the Tentative Acquisition Price payable by the Selected Bidder to the BPC for the acquisition of one hundred percent (100%) of the equity shareholding of RAJASTHAN IV H1 POWER TRANSMISSION LIMITED, along with all its related assets and liabilities is **Rs. 1838.12 Lakhs (Rupees Eighteen Crore Thirty-Eight Lakh Twelve Thousand only)**. This Acquisition Price shall be subject to adjustment based on the audited accounts of RAJASTHAN IV H1 POWER TRANSMISSION LIMITED as on the date of execution of the Share Purchase Agreement.

As per clause no. 3.5 of revised guidelines issued vide Gazette Notification dated 10.08.2021 for BPC (Bid Process Coordinator), price variation between Tentative Acquisition Price and the amount to be paid finally at the end of bidding process by selected bidder should not be more than 5%.

It is further to inform that "Change in Law" would not be applicable on account of Tentative Acquisition Price variation within above mentioned limit.

It may please be noted that as on date, there are no contractual obligations undertaken by BPC on behalf of RAJASTHAN IV H1 POWER TRANSMISSION LIMITED which are to be fulfilled by the TSP.

All other terms and conditions of the RFP remain the same.

Thanking you,

Yours faithfully,

**ATTESTED TRUE COPY**  
Attested from  
Pg 225 - Pg 226  
**Authorized Signatory (Tech)**  
**RAJASTHAN IV H1 POWER TRANSMISSION LIMITED**  
Chief General Manager (Tech)

**REC Power Development and Consultancy Limited**

(Formerly known as REC Power Distribution Company Limited,  
A wholly owned subsidiary of REC Limited, a 'Maharatna CPSE'  
under Ministry of Power, Govt. of India)

**REC**  
Power Development

Ref No.: REC PDCL/Fin/RajIVH1PT1/2024/48

Dated: 28.09.2024

To,  
M/s. Power Grid Corporation of India Limited  
'Saudamini' Plot No.2 Sector-29,  
Gurugram-122001 (Haryana)

Kind Attention: Mr. Pankaj Pandey, I/D

**Subject: Payment of Acquisition Price towards handing over of M/s. RAJASTHAN IV H1 POWER TRANSMISSION LIMITED.**

Sir,

This is to inform that the acquisition price of M/s. Rajasthan IV H1 Power Transmission Limited is Rs 18,80,53,596/- (Rupees Eighteen Crore Eighty Lakh Fifty-Three Thousand Five Hundred Ninety-Six Only) as per the breakup given below:

S. No.	Particulars	Amount (INR)
1	Professional Fee of BPC #	17,70,00,000
2	Reimbursement of cost incurred by BPC #	1,05,53,596
3	Share Capital of Rajasthan IV H1 Power Transmission Ltd	5,00,000
<b>Acquisition Value/ Net Amount Payable by Bidder</b>		<b>18,80,53,596</b>

# including GST

Kindly credit the above total amount i.e., Rs. 18,80,53,596/- in the below mentioned Bank Account of REC Power Development and Consultancy Limited. TDS will be deposited by RECPDCL on behalf and under TAN of Rajasthan IV H1 Power Transmission Limited.

The acquisition price may be credited to our account through RTGS as per the following:

<b>Bank Name, Address &amp; Branch</b>	IDFC First Bank Limited Gurgaon Golf Course Road Branch, Ground Floor Unit no. CG-01A and 01B, Gurgaon - 122003
<b>Bank Account Name</b>	REC Power Development and Consultancy Ltd
<b>Bank Account No</b>	10171707713
<b>Bank IFSC Code No</b>	IDFB0021001

Thanking You,

Yours faithfully

  
(Ch V Lakshmana Charyulu)  
HoD (F&A)



226



SPA

---

**SHARE PURCHASE AGREEMENT**

**BETWEEN**

**REC POWER DEVELOPMENT AND CONSULTANCY LIMITED**

**AND**

**RAJASTHAN IV H1 POWER TRANSMISSION LIMITED**

**AND**

**POWER GRID CORPORATION OF INDIA LIMITED**

---

**Dated: 15<sup>th</sup> October, 2024**

---

**ATTESTED TRUE COPY**

*Attested from Pg 227-19246*

**Authorised Signatory  
RAJASTHAN IV H1 POWER TRANSMISSION LIMITED**



*227*

*[Handwritten signature]*

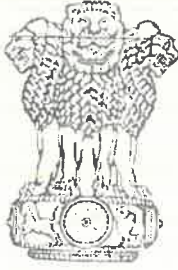

सत्यमेव जयते

INDIA NON JUDICIAL

Government of National Capital Territory of Delhi

e-Stamp

Certificate No.	: IN-DL70720412959588W
Certificate Issued Date	: 14-Oct-2024 03:14 PM
Account Reference	: SELFPRINT (PU)/ dl-self/ NEHRU/ DL-DLH
Unique Doc. Reference	: SUBIN-DL DL-SELF91275260732609W
Purchased by	: REC POWER DEVELOPMENT AND CONSULTANCY LIMITED
Description of Document	: Article 5 General Agreement
Property Description	: CORE-4,SCOPE COMPLEX, 7, LODHI ROAD, NEW DELHI-110003
Consideration Price (Rs.)	: 0 (Zero)
First Party	: RAJASTHAN IV H1 POWER TRANSMISSION LIMITED
Second Party	: POWER GRID CORPORATION OF INDIA LIMITED
Stamp Duty Paid By	: RAJASTHAN IV H1 POWER TRANSMISSION LIMITED
Stamp Duty Amount(Rs.)	: 500 (Five Hundred only)

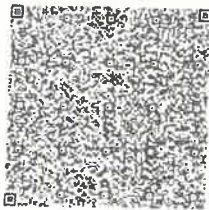

SELF PRINTED CERTIFICATE TO BE VERIFIED BY THE RECIPIENT AT WWW.SHCILESTAMP.COM

SHARE PURCHASE AGREEMENT

This SHARE PURCHASE AGREEMENT ('Agreement') made on the 15<sup>th</sup> day of October, 2024 at New Delhi by and between:

REC POWER DEVELOPMENT AND CONSULTANCY LIMITED, a company incorporated under the Companies Act, 1956, vide CIN-U40101DL2007GOI165779 having its registered office at Core 4, SCOPE Complex, 7, Lodhi Road, New Delhi 110 003, India (hereinafter referred to as "REC PDCL", which expression shall, unless it be repugnant to the context or meaning thereof, be deemed to mean and include its successors and permitted assigns).

Signature of REC PDCL with circular stamp: REC PDCL

Signature of Rajasthan IV H1 PTL with circular stamp: Rajasthan IV H1 PTL

Signature of PGCIL with circular stamp: RAJASTHAN IV H1 POWER TRANSMISSION LIMITED, PGCIL



सत्यमेव जयते

INDIA NON JUDICIAL

Government of National Capital Territory of Delhi

e-Stamp

Certificate No.	: IN-DL70715194336536W
Certificate Issued Date	: 14-Oct-2024 03:09 PM
Account Reference	: SELFPRINT (PU)/ dl-self/ NEHRU/ DL-DLH
Unique Doc. Reference	: SUBIN-DL DL-Self91265803069398W
Purchased by	: REC POWER DEVELOPMENT AND CONSULTANCY LIMITED
Description of Document	: Article 5 General Agreement
Property Description	: CORE-4,SCOPE COMPLEX, 7, LODHI ROAD, NEW DELHI-110003
Consideration Price (Rs.)	: 0 (Zero)
First Party	: RAJASTHAN IV H1 POWER TRANSMISSION LIMITED
Second Party	: POWER GRID CORPORATION OF INDIA LIMITED
Stamp Duty Paid By	: RAJASTHAN IV H1 POWER TRANSMISSION LIMITED
Stamp Duty Amount(Rs.)	: 500 (Five Hundred only)



SELF PRINTED CERTIFICATE TO BE VERIFIED BY THE RECIPIENT AT WWW.SHCILESTAMP.COM

Please write or type below

AND RAJASTHAN IV H1 POWER TRANSMISSION LIMITED a company incorporated under the Companies Act,2013 vide CIN- U42202DL2023GOI421335, having its registered office at Core 4, SCOPE Complex, 7, Lodhi Road, New Delhi 110003, India (herein after referred to as "Company" which expression shall, unless repugnant to the context, mean and include its successors in interest) of the

SECOND PART

Signature of Rajasthan IV H1 PTL

RECPDCL

Signature of PGCIL

Rajasthan IV H1 PTL

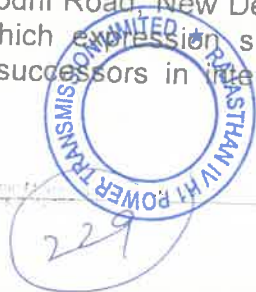

Signature of PGCIL and PGCIL stamp

Small text at the bottom regarding stamp verification and company details.



सत्यमेव जयते

INDIA NON JUDICIAL

Government of National Capital Territory of Delhi

e-Stamp

Certificate No.	: IN-DL70689937756838W
Certificate Issued Date	: 14-Oct-2024 02:46 PM
Account Reference	: SELFPRINT (PU)/ dl-self/ NEHRU/ DL-DLH
Unique Doc. Reference	: SUBIN-DLTL-SELF91219860598615W
Purchased by	: REC POWER DEVELOPMENT AND CONSULTANCY LIMITED
Description of Document	: Article 5 General Agreement
Property Description	: CORE-4,SCOPE COMPLEX, 7, LODHI ROAD, NEW DELHI-110003
Consideration Price (Rs.)	: 0 (Zero)
First Party	: RAJASTHAN IV H1 POWER TRANSMISSION LIMITED
Second Party	: POWER GRID CORPORATION OF INDIA LIMITED
Stamp Duty Paid By	: RAJASTHAN IV H1 POWER TRANSMISSION LIMITED
Stamp Duty Amount(Rs.)	: 200 (Two Hundred only)

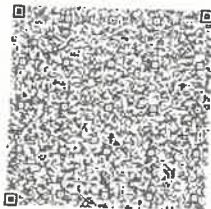

SELF PRINTED CERTIFICATE TO BE VERIFIED BY THE RECIPIENT AT WWW.SHCILESTAMP.COM

Please visit the website for more information

AND POWER GRID CORPORATION OF INDIA LIMITED, a company incorporated under the Companies Act, 1956 vide CIN-L40101DL1989GOI038121 and having its registered office at B-9, Qutab Institutional Area, Katwaria Sarai, New Delhi-110016 (hereinafter referred to as "Selected Bidder" which expression shall, unless repugnant to the context or meaning thereof, be deemed to mean and include its successors and permitted assigns) of the THIRD PART.

Stamp duty paid receipt stamp with signature and RECPOCL stamp

Signature of Rajasthan IV H1 PTL

Handwritten number 250





**WHEREAS:**

- A. The Ministry of Power, Government of India, vide its notification no. 3733 [F. No. 15/3/2018-Trans-Pt(1)] dated 04.09.2023 has appointed REC Power Development and Consultancy Limited to be the Bid Process Coordinator (BPC) for the purpose of selection of Bidder as Transmission Service Provider (TSP) to establish "**Transmission System for Evacuation of Power from Rajasthan REZ Ph-IV (Part-2: 5.5 GW)(Jaisalmer/ Barmer Complex): Part H1**" through tariff based competitive bidding process (hereinafter referred to as the "Project").
- B. In accordance with the Bidding Guidelines, the BPC had initiated a competitive bidding process through issue of RFP for selecting a Successful Bidder to build, own, operate and transfer the Project comprising of the Elements mentioned in **Schedule 2** of the TSA. BPC had initiated this process in accordance with and on the terms and conditions mentioned in the RFP Project Documents (as defined hereinafter).
- C. BPC has incorporated the Company and has undertaken the preliminary studies, obtained certain approvals, etc. regarding the Project on behalf of the Company
- D. REC PDCL along with the Nominees hold one hundred per cent (100%) of the total issued and paid up equity share capital of the Company.
- E. Pursuant to the said Bid Process, Power Grid Corporation of India Limited has been identified as the Selected Bidder vide Letter of Intent dated 18<sup>th</sup> September 2024 issued by the BPC in favour of the Selected Bidder.
- F. As envisaged in the RFP, the Shares Seller (as defined hereinafter) has agreed to sell the Sale Shares (as defined hereinafter) to the Selected Bidder and the Selected Bidder has agreed to purchase the Sale Shares from the Shares Seller, subject to and on the terms and conditions set forth in this Agreement.

**NOW THEREFORE, IN CONSIDERATION OF THE MUTUAL COVENANTS AND AGREEMENTS SET FORTH IN THIS AGREEMENT AND FOR OTHER GOOD AND VALUABLE CONSIDERATION, THE PARTIES HEREBY AGREE AS FOLLOWS:**

  
REC PDCL

  
Rajasthan IV H1 PTL

231



  
PGCIL

1. DEFINITIONS

- 1.1 Capitalised terms in this Agreement, unless defined in this Agreement shall, in so far as the context admits, have the same meaning in this Agreement as has been ascribed to them in the TSA.
- 1.2 Additionally, the following terms shall have the meaning hereinafter respectively assigned to them herein below:
- (i) **“Acquisition Price”** shall mean INR 18,80,53,596 (Rupees Eighteen Crore Eighty Lakh Fifty-Three Thousand Five Hundred Ninety-Six Only), which is the aggregate consideration payable by the Selected Bidder towards purchase of the Sale Shares at par and for taking over of all assets and liabilities of the Company as on the Closing Date subject to adjustment as per the audited accounts of the Company as on the Closing Date;
  - (ii) **“Agreement”** or **“the Agreement”** or **“this Agreement”** shall mean this Share Purchase Agreement and shall include the recitals and/or annexures attached hereto, and the contracts, certificates, disclosures and other documents to be executed and delivered pursuant hereto, if any, and any amendments made to this Agreement by the Parties in writing;
  - (iii) **“Bid Process”** shall mean the competitive bidding process initiated by the BPC, by issuance of RFP for selecting a Successful Bidder to build, own, operate and transfer the Project in accordance with and on the terms and conditions mentioned in the RFP Project Documents;
  - (iv) **“Board”** shall mean the board of directors of the Company;
  - (v) **“Closing Date”** shall mean a mutually agreed date between the Parties falling within the period as mentioned in clause 2.15.2 of RFP or on failure of such mutual agreement between the Parties shall be the date falling on the last date of such period;
  - (vi) **“Encumbrance”** shall mean any mortgage, pledge, lien, charge, security assignment, hypothecation, trust, encumbrance or any other agreement having the effect of creating security interest;
  - (vii) **“Letter of Intent”** shall have the meaning ascribed thereto under the Bid Documents;
  - (viii) **“Nominees”** shall mean the Persons, who are named in Annexure A of this Agreement, holding the Sale Shares as nominees of REC PDCL;

  
REC PDCL

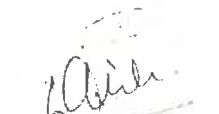
  
Rajasthan IV H1 PTL

232

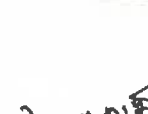
  
PGCL



- (ix) **"Party"** shall mean REC PDCL, Company and the Selected Bidder, referred to individually, and **"Parties"** shall mean REC PDCL, Company and the Selected Bidder collectively referred to, as relevant;
- (x) **"Person"** shall include an individual, an association, a corporation, a partnership, a joint venture, a trust, an unincorporated organisation, a joint stock company or other entity or organisation, including a government or political subdivision, or an agency or instrumentality thereof, and/or any other legal entity;
- (xi) **"RFP Project Documents"** shall mean the following documents, referred to collectively:
- Transmission Service Agreement; and
  - this Agreement.
- (xii) **"Representations and Warranties"** shall mean the representations and warranties mentioned in Clause 4 hereto;
- (xiii) **"RoC"** shall mean the Registrar of Companies;
- (xiv) **"Sale Shares"** shall mean 50,000 shares, representing one hundred percent (100%) of the total issued, subscribed and fully paid-up equity share capital of the Company held by the Shares Seller and Nominees as more particularly described in Annexure A attached hereto;
- (xv) **"Shares"** shall mean the fully paid-up equity shares of Company, of face value Rs. 10 each;
- (xvi) **"Shares Seller"** shall mean REC PDCL; and
- (xvii) **"Transmission Service Agreement"** or **"TSA"** means the agreement titled 'Transmission Service Agreement' to be executed on 15<sup>th</sup> October, 2024 between Central Transmission Utility of India Limited (CTUIL) and Rajasthan IV H1 Power Transmission Limited, pursuant to which the TSP shall build, own, operate and transfer the Project and make available the assets of the Project on a commercial basis.

### 1.3 Interpretation Clause

Unless the context otherwise requires, the provisions of the TSA relating to the interpretation of the TSA shall apply to this Agreement as if they were set out in full in this Agreement and to this end are incorporated herein by reference.

  
REC PDCL

  
Rajasthan IV H1 PTL

  
233

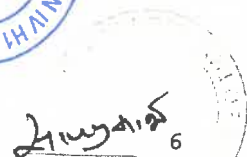
  
PGCIL 6

## 2. TRANSFER OF SHARES

- 2.1 Subject to the terms and conditions of this Agreement, the Shares Seller agrees to sell and transfer to the Selected Bidder and the Selected Bidder hereby agrees to purchase from the Shares Seller, the Sale Shares free from Encumbrances together with all assets and liabilities of the Company with rights and benefits attached thereto in consideration of the Acquisition Price and the covenants, undertakings and the agreements of the Selected Bidder contained in this Agreement.
- 2.2 The Shares Seller hereby undertakes to cause the Nominees to transfer part of the Sale Shares held by them as nominees of the Shares Seller to the Nominees of Selected Bidder and execute any documents required to deliver good title to the Sale Shares to the Selected Bidder.

## 3. CLOSING

- 3.1 Prior to the Closing Date, the Selected Bidder shall provide to the Shares Seller, valid share transfer forms duly stamped with requisite amount of stamp duty payable on the transfer of the Sale Shares ("**Share Transfer Forms**").
- 3.2 On the Closing Date, the Shares Seller shall hand over to the Selected Bidder or its authorised representative, the original share certificates representing the Sale Shares ("**Sale Share Certificates**") executed by the Shares Seller and the Nominees, simultaneously against the Selected Bidder handing over to the Shares Seller, demand drafts drawn in favour of the Shares Seller or by confirmation of RTGS transfer in favour of the Shares Seller, for the Acquisition Price payable to it.

Provided that prior to the handing over of the Sale Share Certificates to the Selected Bidder as mentioned above, the Selected Bidder shall provide satisfactory evidence to REC PDCL that on the Closing Date, the Selected Bidder has furnished the Contract Performance Guarantee to Central Transmission Utility of India Limited (CTUIL) and is in a position to comply with all other requirements of Clause 2.15.2 of the RFP.

- 3.3 The Selected Bidder shall immediately upon receiving the Sale Share Certificates and the Share Transfer Forms, duly execute the Share Transfer Forms and duly lodge the Share Transfer Forms and the Share Certificates with the Company along with the names of its nominees to be appointed on the Board of the Company and the address within the jurisdiction of the Registrar of Companies of New Delhi and Haryana, which would be the new registered office of the Company. The Company shall, upon receipt of the said documents from the Selected Bidder, do the following:

- (i) Immediately on the Closing Date convene a meeting of the Board, wherein the Board shall pass the following necessary resolutions:

  
REC PDCL

  
Rajasthan IV H1 PTL

234





- (a) approving the transfer of the Shares constituting the Sale Shares from the Shares Seller and the Nominees to the name of the **Power Grid Corporation of India Limited** and its nominees and transfer of all assets and liabilities of the Company as on Closing Date;
- (b) approving the **Power Grid Corporation of India Limited** and its nominees as the members of the Company and entering the name of the **Power Grid Corporation of India Limited** and its nominees in the register of members.
- (c) changing the address of the registered office of the Company to the new address as provided by the Selected Bidder as per clause 3.3 above.
- (d) appointing the nominees of the Selected Bidder on the Board and accepting the resignations of the other existing Directors on the Board and the Chair of the meeting which was taken by one of the existing Directors shall be vacated and appointment of a new Chairman who shall be one of the newly appointed Director, for the rest of the meeting.

Immediately pursuant to the acceptance of resignation of the existing Directors and appointment of new Chairman, the newly constituted Board of Directors shall continue with the meeting and pass the following resolution:

- (e) terminating all the authorizations granted regarding the business and/or operations of the Company or the operations of the bank accounts of the Company, with prospective effect; and
  - (f) acknowledging and accepting the terms and conditions as contained in the executed copies of the RFP Project Documents and to abide by the provisions contained therein.
- (ii) Enter the name of the **Power Grid Corporation of India Limited** and its nominees as the legal and beneficial owner of the Sale Shares, free of all Encumbrances, in the register of members of the Company;
  - (iii) Make the necessary endorsements on the Sale Share Certificates, indicating the name of the **Power Grid Corporation of India Limited** and its nominees as the legal and beneficial owner of the Sale Shares evidenced there under;
  - (iv) Return the original Sale Share Certificates, duly endorsed in the name of the **Power Grid Corporation of India Limited** and its nominees, to the **Power Grid Corporation of India Limited** and its nominees as the case may be or its authorized representative;

  
RECPDCL

  
Rajasthan IV H1 PTL

233



- (v) Handover all the statutory registers and records, if any, of the Company to the Selected Bidder.
- (vi) Handover certified true copies of the Board resolution passed by the Company as per (i) (a) to (i) (f) of Clause 3.3 (i) to the Central Transmission Utility of India Limited (CTUIL).

3.4 The Parties to this Agreement agree to take all measures that may be required to ensure that all the events contemplated in the **Clauses 3.1 to 3.3** above on the Closing Date are completed on the same day.

Notwithstanding the provisions of **Clause 3.3** hereto, all proceedings to be taken and all documents to be executed and delivered by the Parties at the Closing Date shall be deemed to have been taken and executed simultaneously and no proceedings shall be deemed to have been taken nor documents executed or delivered until all have been taken, executed and delivered.

3.5 The Selected Bidder hereby acknowledges and agrees that after the date of acquisition of one hundred percent (100%) of the Shares of the Company by the Selected Bidder as per Clause 3.3, (a) the authority of the BPC in respect of the Bid Process shall forthwith cease and any actions to be taken thereafter regarding the Bid Process will be undertaken by the Central Transmission Utility of India Limited (CTUIL) themselves, (b) all rights and obligations of the BPC shall cease forthwith, (c) all other rights and obligations of the Company shall be of the TSP and (d) any decisions taken by the BPC on behalf of the Company prior to the date of acquisition, shall continue to be binding on the Company and/or Central Transmission Utility of India Limited (CTUIL) as the case may be.

3.6 This Agreement shall be effective from the date of its signing by the Parties and shall remain in force until all the obligations of the respective Parties under Clause 3.3 hereto are fulfilled.

#### 4. REPRESENTATIONS AND WARRANTIES

4.1 The Selected Bidder hereby represents and warrants to the Shares Seller that:

4.1.1 The Selected Bidder has full legal right, power and authority to enter into, execute and deliver this Agreement and to perform the obligations, undertakings and transactions set forth herein, and this Agreement has been duly and validly executed and delivered by the Selected Bidder and constitutes its legal, valid and binding obligations, enforceable against it in accordance with its terms;

  
REC PDCL

  
Rajasthan IV H1 PTL



- 4.1.2 The execution, delivery and performance of this Agreement by the Selected Bidder will not violate or contravene any provision of the Memorandum of Association or Articles of the Selected Bidder, (ii) will not violate or contravene any law, statute, rule, regulation, licensing requirement, order, writ, injunction or decree of any court, governmental instrumentality or other regulatory, governmental or public body, agency or authority by which the Selected Bidder is bound or by which any of its and/or their properties or assets are bound, and (iii) except to the extent that the same have been duly and properly completed or obtained, will not require any filing with, or permit, consent or approval of or license from, or the giving of any notice to, any court, governmental instrumentality or other regulatory, governmental or public body, agency or authority, joint venture party, or any other entity or person whatsoever; and
- 4.1.3 The Selected Bidder is not restricted in any manner whatsoever, including without limitation, on account of any judicial or governmental order, action or proceeding, or any contractual obligation assumed by the Selected Bidder, from purchasing the Sale Shares from the Shares Seller in the manner provided for in this Agreement.
- 4.2 The Shares Seller hereby represents and warrants to the Selected Bidder that;
- 4.2.1 The Shares Seller and the Nominees are the legal and beneficial owners of the Sale Shares, free and clear of any Encumbrance and the delivery to the Selected Bidder of the Sale Shares pursuant to the provisions of this Agreement will transfer to the Selected Bidder a good title to the Sale Shares.
- 4.2.2 The Shares Seller has full legal right, power and authority to enter into, execute and deliver this Agreement and to perform the obligations, undertakings and transactions set forth herein. The execution, delivery and performance of this Agreement will not violate the Memorandum and Articles of Association of the Shares Seller or contravene any contract by which it is bound.
- 4.2.3 The Shares Seller has obtained requisite authorizations to sell and transfer the Sale Shares to the Selected Bidder. The Shares Seller also represent that it is not prevented from transferring and selling the Sale Shares. Also, to the best of its knowledge, the Sale Shares are not the subject matter of any claim or pending proceeding or threatened by any legal proceeding made by any third party.
- 4.3 Except as specified in Clause 4.2 above, the Shares Seller shall not be deemed to have, made any representation or warranty whatsoever, whether express or implied, in relation to the Sale Shares or Company, including but not limited to any implied warranty or representation as to the business or affairs of Company.

RECPDCL

Rajasthan IV H1 PTL



- 4.4 The Representations and Warranties are given as at the date of this Agreement except that where a Representation and Warranty is expressed to be made as at another date, the Representation and Warranty is given with respect to that date only.
- 4.5 Each Representation and Warranty is to be construed independently of the others and is not limited by reference to any other Warranty. The Representations, Warranties and undertakings contained in this **Clause 4** hereto or in any document delivered pursuant to or in connection with this Agreement are continuing in nature and shall survive the Closing Date for a period of one (1) year.
- 4.6 The Parties represent to each other that all Representations and Warranties provided herein by the respective Party shall be true as of Closing Date.

## 5. OBLIGATIONS OF THE SELECTED BIDDER

The Selected Bidder agrees that the Shares Seller shall not be liable in any manner, nor shall it assume any responsibility or liability whatsoever, in respect of the business of the Company and its operations or activities, arising after the Closing Date, to any Person or any authority, central, state, local or municipal or otherwise and the same shall be the sole responsibility of the Selected Bidder.

## 6. MISCELLANEOUS

### 6.1 NOTICES

- a) All notices to be given under this Agreement shall be in writing and in the English language.
- b) All notices must be delivered personally or by registered or certified mail or by recognised courier to the addresses below:

Selected Bidder: **Power Grid Corporation of India Limited,**  
B-9, Qutab Institutional Area, Katwaria Sarai,  
New Delhi-110016

REC PDCL: **REC Power Development and Consultancy Limited**  
Core-4, SCOPE Complex, 7, Lodhi Road, New  
Delhi-110003

Company: **Rajasthan IV H1 Power Transmission Limited**  
Core-4, SCOPE Complex, 7, Lodhi Road, New  
Delhi-110003

- c) Any Party may by notice of at least fifteen (15) days to the other Parties change the address and / or addresses to which such notices and communications to it are to be delivered or mailed.

  
RECPDCL

  
Rajasthan IV H1 PTL

238





## 6.2 RESOLUTION OF DISPUTES

- 6.2.1 If any dispute arises between the Parties, in connection with the validity, interpretation, implementation or alleged breach of any provision of this Agreement ("Dispute"), the disputing Parties hereto shall endeavor to settle such Dispute amicably. The attempt to bring about an amicable settlement shall be considered to have failed if not resolved within sixty (60) days from the date of the Dispute.
- 6.2.2 If the Parties are unable to amicably settle the Dispute in accordance with Clause 6.2.1 within the period specified therein, any of the Parties shall be entitled to within thirty (30) days after expiry of the aforesaid period, refer the Dispute to the Chief Executive Officer/Director of REC PDCL and Chief Executive/ Managing Director of the Selected Bidder for resolution of the said Dispute. The attempt to bring about such resolution shall be considered to have failed if not resolved within thirty (30) days from the date of receipt of a written notification in this regard.
- 6.2.3 In the event the Dispute is not settled in accordance with Clause 6.2.2 above, any Party to the Dispute shall be entitled to serve a notice invoking this Clause and making a reference to a sole arbitrator. If the Parties to the Dispute cannot agree as to the appointment of the sole arbitrator within thirty (30) days of receipt of the notice of the Party making the reference, then the Shares Seller along with the Company shall appoint one arbitrator and the Selected Bidder shall appoint one arbitrator and the two arbitrators, so appointed shall appoint a third arbitrator. However, after the Closing Date, in such an event the Shares Seller shall appoint one arbitrator and the Selected Bidder along with the Company shall appoint one arbitrator and the two arbitrators, so appointed shall appoint the third arbitrator.
- 6.2.4 The place of the arbitration shall be New Delhi. The Arbitration proceedings shall be governed by the Arbitration and Conciliation Act, 1996.
- 6.2.5 The proceedings of arbitration shall be in English language.
- 6.2.6 The arbitrator's award shall be substantiated in writing. The arbitrators shall also decide on the costs of the arbitration proceedings. In case the arbitrators have not decided on the costs of the arbitration proceedings, each Party to the Dispute shall bear its own costs, in relation to the arbitration proceedings.

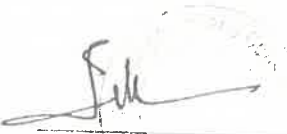

  
RECPDCL

  
Rajasthan IV H1 PTL

239

  
CORPORATION OF INDIA LTD.  
PGCIL

### 6.3 AUTHORISED PERSON

For the purposes of this Agreement, the Selected Bidder is represented by Sh. Satyaprakash Dash, Company Secretary, pursuant to an authorization granted to Sh. Satyaprakash Dash, Company Secretary, through necessary Board resolutions. Further, Sh. Satyaprakash Dash, Company Secretary is also authorized by such resolutions to take any decision which may be required to be taken, do all acts and execute all documents which are or may be required by the Selected Bidder for the proper and effective fulfillment of the rights and obligations under this Agreement. Any action taken or document executed by Sh. Satyaprakash Dash, Company Secretary shall be deemed to be acts done or documents executed by the Selected Bidder and shall be binding on the Selected Bidder.

### 6.4 RESERVATION OF RIGHTS

No forbearance, indulgence or relaxation or inaction by any Party at any time to require performance of any of the provisions of this Agreement shall in any way affect, diminish or prejudice the right of such Party to require performance of that provision, and any waiver or acquiescence by any Party of any breach of any of the provisions of this Agreement shall not be construed as a waiver or acquiescence of any continuing or succeeding breach of such provisions, a waiver of any right under or arising out of this Agreement or acquiescence to or recognition of rights other than that expressly stipulated in this Agreement.

### 6.5 CUMULATIVE RIGHTS

All remedies of either Party under this Agreement whether provided herein or conferred by statute, civil law, common law, custom or trade usage, are cumulative and not alternative and may be enforced successively or concurrently.

### 6.6 PARTIAL INVALIDITY

If any provision of this Agreement or the application thereof to any person or circumstance shall be invalid or unenforceable to any extent, the remainder of this Agreement and the application of such provision to persons or circumstances other than those as to which it is held invalid or unenforceable shall not be affected thereby, and each provision of this Agreement shall be valid and enforceable to the fullest extent permitted by law. Any invalid or unenforceable provision of this Agreement shall be replaced with a provision, which is valid and enforceable and most nearly reflects the original intent of the unenforceable provision.

  
REC PDCL

  
Rajasthan IV H1 PTL



240



## 6.7 TERMINATION

If (i) the Closing does not occur on the Closing Date for any reason whatsoever, or (ii) the Letter of Intent is withdrawn or terminated for any reason, or (iii) due to termination of the TSA by the Central Transmission Utility of India Limited (CTUIL) in accordance with Article 3.3.2 or Article 13 of the TSA thereof, REC PDCL shall have a right to terminate this Agreement forthwith by giving a written notice to the other Parties hereto.

## 6.8 AMENDMENTS

No modification or amendment of this Agreement and no waiver of any of the terms or conditions hereof shall be valid or binding unless made in writing and duly executed by all the Parties.

## 6.9 ASSIGNMENT

This Agreement and the rights and liabilities hereunder shall bind and inure to the benefit of the respective successors of the Parties hereto, but no Party hereto shall assign or transfer its rights and liabilities hereunder to any other Person without the prior written consent of the other Parties, which will not be unreasonably withheld.

## 6.10 ENTIRE AGREEMENT

This Agreement constitutes the entire Agreement between the Parties with respect to the subject matter herein and supersedes and cancels any prior oral or written agreement, representation, understanding, arrangement, communication or expression of intent relating to the subject matter of this Agreement.

## 6.11 COSTS

Each of the Parties hereto shall pay their own costs and expenses relating to the negotiation, preparation and execution of this Agreement and the transactions contemplated by this Agreement.

The Selected Bidder shall be liable to bear and pay the costs in respect of this Agreement and transfer of Sale Shares.

## 6.12 RELATIONSHIP

None of the provisions of this Agreement shall be deemed to constitute a partnership between the Parties hereto and no Party shall have any authority to bind the other Party otherwise than under this Agreement or shall be deemed to be the agent of the other in any way.

  
REC PDCL

  
Rajasthan IV H1 PTL

  
RAJASTHAN IV H1 POWER TRANSMISSION LIMITED

  
CORPORATION OF INDIA LTD  
14  
PGCIL

### 6.13 GOVERNING LAW AND JURISDICTION

This Agreement shall be governed by and construed in accordance with the laws of India and shall be subject to the exclusive jurisdiction of the courts of Delhi.

### 6.14 COUNTERPARTS

This Agreement may be executed in counterparts by the Parties and each fully executed counterpart shall be deemed to be original.

### 6.15 CONFIDENTIALITY

The Parties undertake to hold in confidence and not to disclose the terms and conditions of the transaction contemplated hereby to third parties, except:

- (a) to their professional advisors;
- (b) to their officers, employees, agents or representatives, who need to have access to such information for the proper performance of their activities;
- (c) disclosures required under Law;

without the prior written consent of the other Parties.

Provided that the Central Transmission Utility of India Limited (CTUIL) and REC PDCL may at any time, disclose the terms and conditions of transactions contemplated hereby to any person, to the extent stipulated under the law or the Bidding Guidelines.

### 6.16 INDEMNIFICATION

The Parties hereby agree that transfer of Sale Shares to the Selected Bidder shall vest all the rights, privileges, licenses, responsibilities, liabilities and other obligations pertaining to the Company in the Selected Bidder.

- The Selected Bidder hereby agrees that the Selected Bidder shall not be entitled to any claims or initiate any legal proceedings by itself or through the Transmission Service Provider against the Shares Seller, its directors, officers, employees and the subscribers including the members of any committees appointed by them in respect of any actions or decisions taken by any of them up to the Closing Date in furtherance of the Project referred to in recital A of this Agreement.
- Further, the Selected Bidder hereby indemnifies and holds harmless at all times the Shares Seller against all past, present and future third party claims and liabilities arising out of actions or decisions taken by any of the persons or bodies referred to in Clause 6.3 up to the Closing Date in furtherance of the Project referred to above or otherwise concerning the

  
REC PDCL

  
Rajasthan IV H1 PTL

242

  
PGCIL





Company. All such actions shall be defended by the Selected Bidder either itself or through the TSP at its own cost.

- The Parties hereby agree that the provisions of this clause shall survive the termination of this Agreement.

#### 6.17 SURVIVAL

The provisions of Clause 1 (Definitions and Interpretation), Clause 4 (Representations and Warranties), Clause 6.2 (Resolution of Disputes), Clause 6.7 (Termination), Clause 6.15 (Confidentiality), Clause 6.16 (Indemnification) and other representations, warranties, covenants and provisions contained herein that by their nature are intended to survive, shall survive the termination of this Agreement

#### 6.18 FORCE MAJEURE

No party shall be liable for its inability or delay in performing any of its obligations hereunder if such delay is caused by circumstances beyond the reasonable control of the party including delay caused through flood, riot, Act of God, lighting civil commotion, storm, tempest and earthquake.

**IN WITNESS WHEREOF, THE PARTIES HERETO HAVE CAUSED THIS AGREEMENT TO BE DULY EXECUTED AND DELIVERED AS OF THE DAY AND YEAR FIRST ABOVE WRITTEN**

  
RECPDCL

  
Rajasthan IV H1 PTL

243

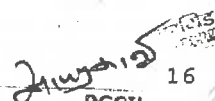
  
PGCIL 16



SIGNED AND DELIVERED by the within named **REC POWER DEVELOPMENT AND CONSULTANCY LIMITED** by the hand of Sh. TSC Bosh, CEO

(Authorised pursuant to the resolution passed by its Board of Directors in its meeting held on 26<sup>th</sup> September, 2024)



IN THE PRESENCE OF:

WITNESS:  
(Name and address)

1. SATYABAN SAHOO  
GM (TECH)



(Core-4, SCOPE Complex, 7,  
Lodhi Road, New Delhi-110003)

SHRINIVAS GOEL  
ANALYST



(Core-4, SCOPE Complex, 7,  
Lodhi Road, New Delhi-110003)

SIGNED AND DELIVERED by the within named **RAJASTHAN IV H1 POWER TRANSMISSION LIMITED** by the hand of Sh. Debasis Mitra, Director

(Authorised pursuant to the resolution passed by its Board of Directors in its meeting held on 15<sup>th</sup> October, 2024)



WITNESS:  
(Name and address)

(CH. V. Lakshminarayana Charyulu)  
GM & MOD (F)

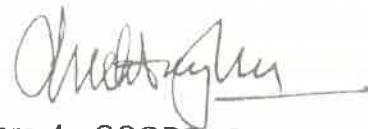

(Core-4, SCOPE Complex, 7,  
Lodhi Road, New Delhi-110003)

(KIRAN KUMAR BERA)  
GM (F)



(Core-4, SCOPE Complex, 7,  
Lodhi Road, New Delhi-110003)

SIGNED AND DELIVERED by the within  
named **POWER GRID CORPORATION  
OF INDIA LIMITED** by the hand of  
Satyaprakash Dash, Company Secretary

(Authorised pursuant to the resolution  
passed by Committee of Board of  
Directors in its meeting held on 16<sup>th</sup>  
December, 2023)



WITNESS:  
(Name and address)

*Kaushal Kishor*  
(Kaushal Kishor)

B-9, Qutab Institutional Area,  
Katwaria Sarai, New Delhi-110016

*Arup Samal*  
(Arup Samal)

B-9, Qutab Institutional Area,  
Katwaria Sarai, New Delhi-110016



*245*

**ANNEXURE A**

**DESCRIPTION OF THE SALE SHARES**

S. NO.	NAME OF THE SHAREHOLDER	NUMBER OF EQUITY SHARES HELD	PERCENTAGE OF THE TOTAL PAID UP EQUITY CAPITAL
1.	REC POWER DEVELOPMENT AND CONSULTANCY LIMITED	49,994	99.988
2.	Shri Thangarajan Bosh*	1	0.002
3.	Shri Sahab Narain*	1	0.002
4.	Shri Satyaban Sahoo*	1	0.002
5.	Shri Alok Singh*	1	0.002
6.	Shri Mohan Lal Kumawat*	1	0.002
7.	Shri Arvind Kumar*	1	0.002
	Total	50,000	100.000

\* Held as nominee of REC PDCL.



Rajasthan IV H1 PTL



246









1. To constitute, and defend legal cases, sign and verify plaints, written statements, petitions and objections, memorandum of appeal, claims, affidavits, applications, re-applications and pleadings of all kinds and to file them in Central Electricity Regulatory Commission (CERC), State Electricity Regulatory Commissions (SERCs), Appellate Tribunal for Electricity (ATE), Civil, Criminal or Revenue courts, Arbitration, Labour Court, Industrial Tribunal, High Court and Supreme Court, whether having original or appellate jurisdiction and before Government or Local Authorities or Registration Authorities, Tax Authorities, Tribunals, etc.
2. To appear, before various Courts / Tribunals / CERC / SERCs / Appellate Tribunal for Electricity.
3. To appoint any Advocate, Vakil, Pleader, Solicitor or any other legal practitioner as Attorney to appear and conduct case proceedings on behalf of the company and to sign Vakalatnama.
4. To compromise, compound or withdraw cases from any Court / Tribunal / CERC / SERCs / Appellate Tribunal for Electricity.
5. To file petitions/applications or affidavits before the Supreme Court / High Court / CERC / SERCs / Appellate Tribunal for Electricity and to obtain the copies of documents, papers, records etc.
6. To file and receive back documents, to deposit and withdraw money from Courts, Tribunal, Registrar's Office and other Government or Local Authorities and to issue valid receipts thereof.
7. To apply for and obtain refund of stamp duty or court fee, etc.
8. To issue notices and accept service of any summons, notices or orders issued by any Court / Tribunal / CERC / SERCs / Appellate Tribunal for Electricity on behalf of the Company.
9. To execute deeds, agreements, bonds and other documents and returns in connection with the affairs of the company and file them or cause to be filed for Registration, whenever necessary.
10. To issue Project Authority Certificate(s) in respect of contracts for Load Despatch & Communication Systems, Transmission Systems etc. and to lodge claims with the Railways, Transporters, Shipping Agents and Clearing Agents and to settle/compromise such claims.
11. To lodge claims with the Insurance companies, to settle/compromise such claims and on satisfactory settlement thereof, to issue letters of subrogation/power of attorney in favour of Insurance companies.
12. To execute, sign and file applications, undertakings, agreements etc. to or with the Central / State Government(s) / Body(ies) to obtain 'right of way' or any of other Right(s) / Privilege(s) etc.
13. To execute, sign and file applications, undertakings, agreements, bills, documents etc. to or with the Central / State Government(s) / Body(ies) and other authorities / entities including Central Transmission Utility (CTU)/Power System Operation Corporation Limited (POSOCO) / Central Electricity Authority (CEA)/ CERC with respect to Commissioning

B. S. Amin

249



of the Project, realization of Transmission charges, to obtain 'right of way' or any of other Right(s) / Privilege(s) etc.

14. To execute Transmission Service Agreement (TSA) with Central Transmission Utility of India Limited (CTUIL)
15. To execute Consultancy, Funding and other Agreements.
16. To act as administrator for e-filing process with CERC and other Statutory authorities.
17. Generally to do all lawful acts, necessary for the above mentioned purposes.

The Company hereby agrees to ratify and confirm all and whatsoever the said Attorney shall lawfully do execute or perform or cause to be done, executed or performed in exercise of the power or authority conferred under and by virtue of this Power of Attorney.

.....  
.....

Signed by the within named

**Rajasthan IV H1 Power Transmission Limited**

through the hand of

Duly authorized by the Board to issue such Power of Attorney

Dated this 15<sup>th</sup> day of October, 2024

Accepted

.....  
.....

Signature of Attorney

Name: Shri Rajendra Kumar Gupta

Designation: Project Incharge, RIVH1PTL

Address: D2, POWERGRID Township, Patan Road, Sukha, Jabalpur, MP-482002

.....  
.....

Attested

.....  
.....

(Signature of the Executant)

Name: B.V Rama Mohan

Designation: Chairman

Address: B-9, Qutab Institutional Area, Katwaria Sarai, New Delhi - 110 016

.....  
Signature and Stamp of Notary of the place of execution

WITNESS

250

